

ALLEGATO B

**Specifiche tecniche per la trasmissione
dei modelli 730-4/2017 e 730-4/2017 integrativo
all'INPS**

SPECIFICHE TECNICHE PER LA TRASMISSIONE DELLE COMUNICAZIONI RELATIVE AL RISULTATO CONTABILE CHE I CENTRI DI ASSISTENZA FISCALE ED I PROFESSIONISTI ABILITATI DEVONO INVIARE ALL'INPS (MODELLO 730-4 E 730-4 INTEGRATIVO)

1. AVVERTENZE GENERALI

I CAF dipendenti e i professionisti abilitati sono tenuti ad inviare, in via telematica, all'INPS la comunicazione con l'esito contabile delle dichiarazioni ai fini del conguaglio, a credito o a debito, da effettuare in sede di ritenuta d'acconto.

Il linguaggio adottato è quello XML (eXtensible Markup Language).

L'XML è un metalinguaggio, ossia una “grammatica”, per la definizione di documenti da gestire con strumenti informatici. Per “grammatica” si intende l'insieme standard di definizioni e di regole sintattiche mediante le quali la struttura logica di un documento viene tradotta in una corrispondente struttura fisica, composta di elementi sintattici chiamati **tag**, ossia sequenze di caratteri delimitate dai segni '<' e '>'.

Concretamente, un file XML è un file di testo costituito da diversi **elementi** individuati dai **tag**, ciascuno dei quali identifica un componente logico del documento.

Gli **elementi** sono organizzati secondo una **struttura gerarchica**: ciascun **elemento** può infatti contenere altri elementi (**sottoelementi**) oppure del testo. L'elemento principale della struttura “ad albero” così ottenuta è denominato **radice (root element)**.

La fornitura oggetto della trasmissione telematica deve essere conforme alle specifiche dell'eXtensible Markup Language (XML) 1.0 (raccomandazione WC3 10 febbraio 1998) e deve essere codificata secondo la codifica UTF-8.

Il contenuto della fornitura xml, deve inoltre soddisfare la sintassi descritta nel file XSD denominato “**fornitura734_Inps_2017_v1.xsd**”, allegato al presente documento.

Schema forniture734_Inps_2017_v1.xsd

schema location: [forniture734_Inps_2017_v1.xsd](#)
 attribute form default: **unqualified**
 element form default: **qualified**
 targetNamespace: **urn:www.agenziaentrate.gov.it:specificheTecniche:sco:730**

Elements

[FornitureInps730-4](#)

element FornitureInps730-4

diagram	
namespace	urn:www.agenziaentrate.gov.it:specificheTecniche:sco:730
children	m730:Intestazione m730:Documento_730-4

element FornitureInps730-4/Intestazione

diagram	
namespace	urn:www.agenziaentrate.gov.it:specificheTecniche:sco:730
children	m730:CodiceFornitura m730:TotaleDocumenti m730:CodiceFiscaleSostituto m730:SoggettoAssFiscale730-4 m730:Informazioni Servizio

element FornitureInps730-4/Intestazione/CodiceFornitura

diagram					
namespace	urn:www.agenziaentrate.gov.it:specificheTecniche:sco:730				
type	DatoAN_Type				
facets	<table border="0"> <tr> <td>Kind</td> <td>Value</td> </tr> <tr> <td>pattern</td> <td>(([0-9A-Z-])&quot;){1}([0-9A-Z&#39;] " - \. / "^\(\\) À È É Ì Ò Ù Û &quot; \\ / +)*</td> </tr> </table>	Kind	Value	pattern	(([0-9A-Z-])"){1}([0-9A-Z'] " - \. / "^\(\\) À È É Ì Ò Ù Û " \\ / +)*
Kind	Value				
pattern	(([0-9A-Z-])"){1}([0-9A-Z'] " - \. / "^\(\\) À È É Ì Ò Ù Û " \\ / +)*				

element **FornituraInps730-4/Intestazione/TotaleDocumenti**

diagram	
namespace	urn:www.agenziaentrate.gov.it:specificheTecniche:sco:730
type	DatoNP_Type
facets	Kind Value pattern [1-9]{1}[0-9]*

element **FornituraInps730-4/Intestazione/CodiceFiscaleSostituto**

diagram	
namespace	urn:www.agenziaentrate.gov.it:specificheTecniche:sco:730
type	DatoCN_Type
facets	Kind Value pattern [0-9]{11}

element **FornituraInps730-4/Intestazione/SoggettoAssFiscale730-4**

diagram	
namespace	urn:www.agenziaentrate.gov.it:specificheTecniche:sco:730
children	m730:DatiCaf730-4 m730:DatiProfessionista730-4 m730:DatiAssociazione730-4

element **FornituraInps730-4/Intestazione/SoggettoAssFiscale730-4/DatiCaf730-4**

diagram	
---------	--

namespace	urn:www.agenziaentrate.gov.it:specificheTecniche:sco:730
type	extension of m730:Dati_CAF_Type
children	m730:CFCaf m730:DenominazioneCaf m730:NumeroAlbo m730:DomicilioCaf m730:UfficioPerifericoCaf

element **FornituraInps730-4/Intestazione/SoggettoAssFiscale730-4/DatiCaf730-4/DomicilioCaf**

diagram	<pre> classDiagram class m730DomicilioCaf class m730Domicilio_Sogg_Ass_Fiscale_Type { m730Comune m730Provincia m730CodiceComune m730Cap m730Indirizzo m730Telefono m730FAX m730Email } m730DomicilioCaf m730Domicilio_Sogg_Ass_Fiscale_Type </pre>
namespace	urn:www.agenziaentrate.gov.it:specificheTecniche:sco:730
type	m730:Domicilio_Sogg_Ass_Fiscale_Type
children	m730:Comune m730:Provincia m730:CodiceComune m730:Cap m730:Indirizzo m730:Telefono m730:FAX m730:Email

element **FornituraInps730-4/Intestazione/SoggettoAssFiscale730-4/DatiCaf730-4/UfficioPerifericoCaf**

diagram	<pre> classDiagram class m730UfficioPerifericoCaf class m730DomicilioUffPeriferico m730UfficioPerifericoCaf m730DomicilioUffPeriferico </pre>
namespace	urn:www.agenziaentrate.gov.it:specificheTecniche:sco:730
children	m730:DomicilioUffPeriferico

element **FornituraInps730-4/Intestazione/SoggettoAssFiscale730-4/DatiCaf730-4/UfficioPerifericoCaf/DomicilioUffPeriferico**

diagram	
namespace	urn:www.agenziaentrate.gov.it:specificheTecniche:sco:730
type	extension of m730:Domicilio_Sogg_Ass_Fiscale_Type
children	m730:Comune m730:Provincia m730:CodiceComune m730:Cap m730:Indirizzo m730:Telefono m730:FAX m730:Email m730:CodiceSedePeriferica

element **FornituraInps730-4/Intestazione/SoggettoAssFiscale730-4/DatiCaf730-4/UfficioPerifericoCaf/DomicilioUffPeriferico/CodiceSedePeriferica**

diagram					
namespace	urn:www.agenziaentrate.gov.it:specificheTecniche:sco:730				
type	DatoAN_Type				
facets	<table border="1"> <thead> <tr> <th>Kind</th> <th>Value</th> </tr> </thead> <tbody> <tr> <td>pattern</td> <td>([0-9A-Z-] \&quot;){1}([0-9A-Z&amp;:] ' - \., / °\^\(\ \) À È É Ì Ò Ù Û &quot; \N\ +)*</td> </tr> </tbody> </table>	Kind	Value	pattern	([0-9A-Z-] \"){1}([0-9A-Z&:] ' - \., / °\^\(\ \) À È É Ì Ò Ù Û " \N\ +)*
Kind	Value				
pattern	([0-9A-Z-] \"){1}([0-9A-Z&:] ' - \., / °\^\(\ \) À È É Ì Ò Ù Û " \N\ +)*				

element FornituraInps730-4/Intestazione/SoggettoAssFiscale730-4/DatiProfessionista730-4

diagram	<p>The diagram shows a class <code>m730:DatiProfessionista730-4</code> extending the class <code>m730:Dati_Professionista_Type (extension)</code>. The extension includes four child elements: <code>m730:CFProfessionista</code>, <code>m730:CognomeProfessionista</code>, <code>m730:NomeProfessionista</code>, and <code>m730:DomicilioProf</code>.</p>
namespace	urn:www.agenziaentrate.gov.it:specificheTecniche:sco:730
type	extension of m730:Dati Professionista Type
children	m730:CFProfessionista m730:CognomeProfessionista m730:NomeProfessionista m730:DomicilioProf

element FornituraInps730-4/Intestazione/SoggettoAssFiscale730-4/DatiProfessionista730-4/DomicilioProf

diagram	<p>The diagram shows a class <code>m730:DomicilioProf</code> extending the class <code>m730:Domicilio_Sogg_Ass_Fiscale_Type</code>. The extension includes eight child elements: <code>m730:Comune</code>, <code>m730:Provincia</code>, <code>m730:CodiceComune</code>, <code>m730:Cap</code>, <code>m730:Indirizzo</code>, <code>m730:Telefono</code>, <code>m730:FAX</code>, and <code>m730:Email</code>.</p>
namespace	urn:www.agenziaentrate.gov.it:specificheTecniche:sco:730
type	m730:Domicilio Sogg Ass Fiscale Type
children	m730:Comune m730:Provincia m730:CodiceComune m730:Cap m730:Indirizzo m730:Telefono m730:FAX m730:Email

element FornituraInps730-4/Intestazione/SoggettoAssFiscale730-4/DatiAssociazione730-4

diagram	
namespace	urn:www.agenziaentrate.gov.it:specificheTecniche:sco:730
type	extension of m730:Dati Associazioni Professionale Type
children	m730:CFAssociazione m730:DenominazioneAssociazione m730:CFProfessionista m730:CognomeProfessionista m730:NomeProfessionista m730:DomicilioAssociazione

element FornituraInps730-4/Intestazione/SoggettoAssFiscale730-4/DatiAssociazione730-4/DomicilioAssociazione

diagram	
namespace	urn:www.agenziaentrate.gov.it:specificheTecniche:sco:730
type	m730:Domicilio Sogg Ass Fiscale Type
children	m730:Comune m730:Provincia m730:CodiceComune m730:Cap m730:Indirizzo m730:Telefono m730:FAX m730:Email

element **FornituraInps730-4/Documento_730-4**

diagram	
namespace	urn:www.agenziaentrate.gov.it:specificheTecniche:sco:730
type	m730:Documento_730-4
children	m730:DatiAnagraficiDichiarante m730:Sostituto m730:SoggettoAssFiscale730-4 m730:AltriDati m730:DatiContabili730-4

element **Documento730**

diagram	
namespace	urn:www.agenziaentrate.gov.it:specificheTecniche:sco:730

type	m730:Documento 730 Type				
children	m730:DichiarazioneDich m730:DichiarazioneCon m730:AltriDati m730:Sostituto m730:Mod730DipendentiSenzaSostituto m730:SoggettoAssFiscaleDoc m730:Documento 730-4 m730:EsitiContabili m730:DatiRettificati				
attributes	Name identificativo	Type Identificativo_Type	Use required	Default	Fixed

complexType [Acconti_Altri_Dati_Type](#)

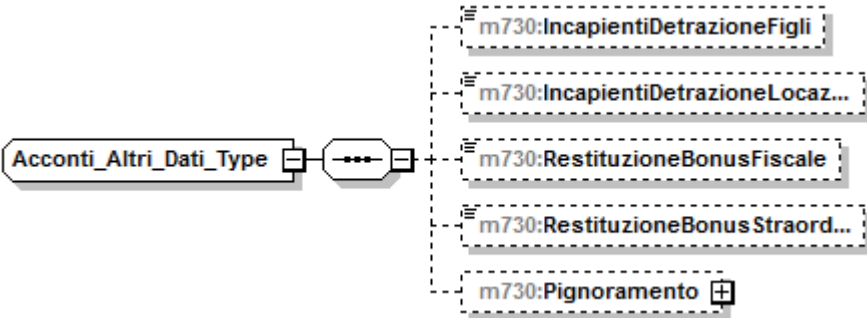
diagram	
namespace	urn:www.agenziaentrate.gov.it:specificheTecniche:sco:730
children	m730:IncapientiDetrazioneFigli m730:IncapientiDetrazioneLocazione m730:RestituzioneBonusFiscale m730:RestituzioneBonusStraordinario m730:Pignoramento

element [Acconti_Altri_Dati_Type/IncapientiDetrazioneFigli](#)

diagram	
namespace	urn:www.agenziaentrate.gov.it:specificheTecniche:sco:730
type	DatoNP_Type
facets	Kind Value pattern [1-9]{1}[0-9]*

element [Acconti_Altri_Dati_Type/IncapientiDetrazioneLocazione](#)

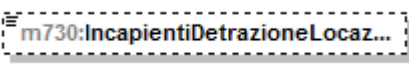
diagram	
namespace	urn:www.agenziaentrate.gov.it:specificheTecniche:sco:730
type	DatoNP_Type
facets	Kind Value pattern [1-9]{1}[0-9]*

element [Acconti_Altri_Dati_Type/RestituzioneBonusFiscale](#)

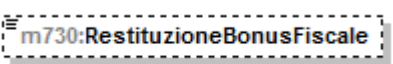
diagram	
---------	---

namespace	urn:www.agenziaentrate.gov.it:specificheTecniche:sco:730
type	DatoNP_Type
facets	Kind Value pattern [1-9]{1}[0-9]*

element **Acconti_Altri_Dati_Type/RestituzioneBonusStraordinario**

diagram	
namespace	urn:www.agenziaentrate.gov.it:specificheTecniche:sco:730
type	DatoNP_Type
facets	Kind Value pattern [1-9]{1}[0-9]*

element **Acconti_Altri_Dati_Type/Pignoramento**

diagram	
namespace	urn:www.agenziaentrate.gov.it:specificheTecniche:sco:730
type	m730:Pignoramento_Type
children	m730:TipoRedditoPignoramento m730:RitenutePignoramento

complexType **Acconti_Irpef_Anno_Imposta_Type**

diagram	
namespace	urn:www.agenziaentrate.gov.it:specificheTecniche:sco:730
children	m730:PrimaRataAccontolrpef m730:SecondaRataAccontolrpef m730:AccontoAddComunale m730:AccontoAddComunaleF24 m730:PrimaRataAccontoCedolare m730:SecondaRataAccontoCedo...

element **Acconti_Irpef_Anno_Imposta_Type/PrimaRataAccontolrpef**

diagram	 m730:PrimaRataAccontolrpef
namespace	urn:www.agenziaentrate.gov.it:specificheTecniche:sco:730
type	DatoNP_Type
facets	Kind Value pattern [1-9]{1}[0-9]*

element **Acconti_Irpef_Anno_Imposta_Type/SecondaRataAccontolrpef**

diagram	 m730:SecondaRataAccontolrpef
namespace	urn:www.agenziaentrate.gov.it:specificheTecniche:sco:730
type	DatoNP_Type
facets	Kind Value pattern [1-9]{1}[0-9]*

element **Acconti_Irpef_Anno_Imposta_Type/AccontoAddComunale**

diagram	 m730:AccontoAddComunale
namespace	urn:www.agenziaentrate.gov.it:specificheTecniche:sco:730
type	DatoNP_Type
facets	Kind Value pattern [1-9]{1}[0-9]*

element **Acconti_Irpef_Anno_Imposta_Type/AccontoAddComunaleF24**

diagram	 m730:AccontoAddComunaleF24
namespace	urn:www.agenziaentrate.gov.it:specificheTecniche:sco:730
type	DatoNP_Type
facets	Kind Value pattern [1-9]{1}[0-9]*

element **Acconti_Irpef_Anno_Imposta_Type/PrimaRataAccontoCedolare**

diagram	 m730:PrimaRataAccontoCedolare
namespace	urn:www.agenziaentrate.gov.it:specificheTecniche:sco:730
type	DatoNP_Type
facets	Kind Value pattern [1-9]{1}[0-9]*

element **Acconti_Irpef_Anno_Imposta_Type/SecondaRataAccontoCedolare**

diagram	
namespace	urn:www.agenziaentrate.gov.it:specificheTecniche:sco:730
type	DatoNP_Type
facets	Kind Value pattern [1-9]{1}[0-9]*

complexType **Acconti_Ritenute_Type**

diagram	
namespace	urn:www.agenziaentrate.gov.it:specificheTecniche:sco:730
children	m730:PrimoModulo m730:Modulo

element **Acconti_Ritenute_Type/PrimoModulo**

diagram	
namespace	urn:www.agenziaentrate.gov.it:specificheTecniche:sco:730
type	m730:Primo_Modulo_Acconti_Ritenute_Type
children	m730:Accontilrpef m730:AltreRitenute m730:Eccedenze m730:EccedenzeOltreAnno m730:RitenuteAccontiSospesi m730:MisuraAcconti m730:EsenzioneAddComunale m730:Dati730Integrativo m730:AccontiAltriDati

	m730:MisuraAcconti m730:EsenzioneAddComunale m730:Dati730Integrativo m730:AccontiAltriDati
--	--

element **Acconti_Ritenute_Type/Modulo**

diagram	
namespace	urn:www.agenziaentrate.gov.it:specificheTecniche:sco:730
children	m730:Pignoramento

element **Acconti_Ritenute_Type/Modulo/Pignoramento**

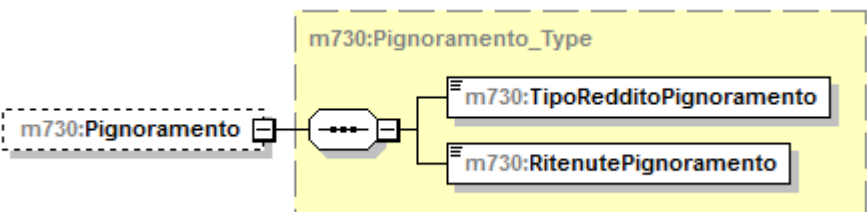
diagram	
namespace	urn:www.agenziaentrate.gov.it:specificheTecniche:sco:730
type	m730:Pignoramento_Type
children	m730:TipoRedditoPignoramento m730:RitenutePignoramento

complexType **Acoonti_Compensati_Intern_Type**

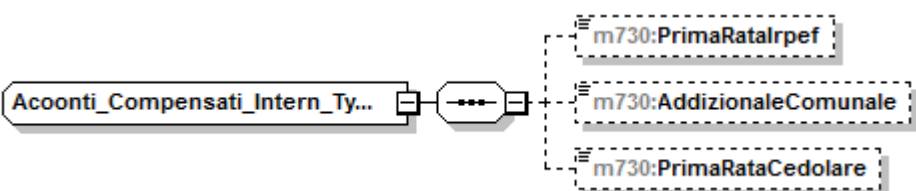
diagram	
namespace	urn:www.agenziaentrate.gov.it:specificheTecniche:sco:730
children	m730:PrimaRatalrpef m730:AddizionaleComunale m730:PrimaRataCedolare

element **Acoonti_Compensati_Intern_Type/PrimaRatalrpef**

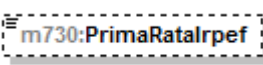
diagram					
namespace	urn:www.agenziaentrate.gov.it:specificheTecniche:sco:730				
type	DatoNP_Type				
facets	<table border="1"> <tr> <td>Kind</td> <td>Value</td> </tr> <tr> <td>pattern</td> <td>[1-9]{1}[0-9]*</td> </tr> </table>	Kind	Value	pattern	[1-9]{1}[0-9]*
Kind	Value				
pattern	[1-9]{1}[0-9]*				

element **Acoonti_Compensati_Intern_Type/AddizionaleComunale**

diagram	
namespace	urn:www.agenziaentrate.gov.it:specificheTecniche:sco:730
type	DatoNP_Type
facets	Kind Value pattern [1-9]{1}[0-9]*

element **Acoonti_Compensati_Intern_Type/PrimaRataCedolare**

diagram	
namespace	urn:www.agenziaentrate.gov.it:specificheTecniche:sco:730
type	DatoNP_Type
facets	Kind Value pattern [1-9]{1}[0-9]*

complexType **Acquisto_Costruzione_Abit_Type**

diagram	
namespace	urn:www.agenziaentrate.gov.it:specificheTecniche:sco:730
children	m730:DataStipula m730:Spesa m730:InteressiMutuo

element **Acquisto_Costruzione_Abit_Type/DataStipula**

diagram	
namespace	urn:www.agenziaentrate.gov.it:specificheTecniche:sco:730
type	DatoDT_Type
facets	Kind Value pattern (((([1-9][12][0-9][3][01])(0[13578][10]12)(\d{4}))) ((([1-9][12][0-9][30](0[469][11](\d{4}))) ((0[1-9][1][0-9][2][0-8])(02)(\d{4}))) ((29)(02)([02468][048]00)) ((29)(02)([13579][26]00)) ((29)(02)([0-9][0-9][0][48])) ((29)(02)([0-9][0-9][2468][048])) ((29)(02)([0-9][0-9][13579][26])))))

element **Acquisto_Costruzione_Abit_Type/Spesa**

diagram	
namespace	urn:www.agenziaentrate.gov.it:specificheTecniche:sco:730

type	DatoNP_Type
facets	Kind Value pattern [1-9]{1}[0-9]*

element **Acquisto_Costruzione_Abit_Type/InteressiMutuo**

diagram	
namespace	urn:www.agenziaentrate.gov.it:specificheTecniche:sco:730
type	DatoNP_Type
facets	Kind Value pattern [1-9]{1}[0-9]*

complexType **Addizionali_Type**

diagram	
namespace	urn:www.agenziaentrate.gov.it:specificheTecniche:sco:730
children	m730:Imponibile m730:AddRegDovuta m730:AddRegCertif m730:EccedenzaAddReg m730:AddComDovuta m730:AddComCertif m730:EccedenzaAddCom m730:AccontoAddCom m730:AccontoAddComCertif

element **Addizionali_Type/Imponibile**

diagram	
namespace	urn:www.agenziaentrate.gov.it:specificheTecniche:sco:730
type	DatoNP_Type
facets	Kind Value pattern [1-9]{1}[0-9]*

element **Addizionali_Type/AddRegDovuta**

diagram					
namespace	urn:www.agenziaentrate.gov.it:specificheTecniche:sco:730				
type	DatoNP_Type				
facets	<table border="1"> <tr> <td>Kind</td> <td>Value</td> </tr> <tr> <td>pattern</td> <td>[1-9]{1}[0-9]*</td> </tr> </table>	Kind	Value	pattern	[1-9]{1}[0-9]*
Kind	Value				
pattern	[1-9]{1}[0-9]*				

element **Addizionali_Type/AddRegCertif**

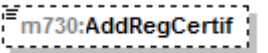
diagram					
namespace	urn:www.agenziaentrate.gov.it:specificheTecniche:sco:730				
type	DatoNP_Type				
facets	<table border="1"> <tr> <td>Kind</td> <td>Value</td> </tr> <tr> <td>pattern</td> <td>[1-9]{1}[0-9]*</td> </tr> </table>	Kind	Value	pattern	[1-9]{1}[0-9]*
Kind	Value				
pattern	[1-9]{1}[0-9]*				

element **Addizionali_Type/EccedenzaAddReg**

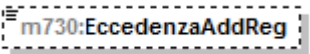
diagram					
namespace	urn:www.agenziaentrate.gov.it:specificheTecniche:sco:730				
type	DatoNU_Type				
facets	<table border="1"> <tr> <td>Kind</td> <td>Value</td> </tr> <tr> <td>pattern</td> <td>(\-[1-9] [1-9])[0-9]*</td> </tr> </table>	Kind	Value	pattern	(\-[1-9] [1-9])[0-9]*
Kind	Value				
pattern	(\-[1-9] [1-9])[0-9]*				

element **Addizionali_Type/AddComDovuta**

diagram					
namespace	urn:www.agenziaentrate.gov.it:specificheTecniche:sco:730				
type	DatoNP_Type				
facets	<table border="1"> <tr> <td>Kind</td> <td>Value</td> </tr> <tr> <td>pattern</td> <td>[1-9]{1}[0-9]*</td> </tr> </table>	Kind	Value	pattern	[1-9]{1}[0-9]*
Kind	Value				
pattern	[1-9]{1}[0-9]*				

element **Addizionali_Type/AddComCertif**

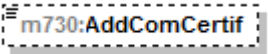
diagram					
namespace	urn:www.agenziaentrate.gov.it:specificheTecniche:sco:730				
type	DatoNP_Type				
facets	<table border="1"> <tr> <td>Kind</td> <td>Value</td> </tr> <tr> <td>pattern</td> <td>[1-9]{1}[0-9]*</td> </tr> </table>	Kind	Value	pattern	[1-9]{1}[0-9]*
Kind	Value				
pattern	[1-9]{1}[0-9]*				

element **Additionali_Type/EccedenzaAddCom**

diagram	
namespace	urn:www.agenziaentrate.gov.it:specificheTecniche:sco:730
type	DatoNU_Type
facets	Kind Value pattern $(\backslash-[1-9][1-9])[0-9]^*$

element **Additionali_Type/AccontoAddCom**

diagram	
namespace	urn:www.agenziaentrate.gov.it:specificheTecniche:sco:730
type	DatoNP_Type
facets	Kind Value pattern $[1-9]\{1\}[0-9]^*$

element **Additionali_Type/AccontoAddComCertif**

diagram	
namespace	urn:www.agenziaentrate.gov.it:specificheTecniche:sco:730
type	DatoNP_Type
facets	Kind Value pattern $[1-9]\{1\}[0-9]^*$

complexType **Altre_Detrazioni_Type**

diagram	
namespace	urn:www.agenziaentrate.gov.it:specificheTecniche:sco:730
children	m730:Codice m730:Importo

element **Altre_Detrazioni_Type/Codice**

diagram	
namespace	urn:www.agenziaentrate.gov.it:specificheTecniche:sco:730
type	m730:Codice Altre_Detrazioni_Type

facets	Kind	Value
	pattern	[1-9]{1}[0-9]*
	enumeration	1
	enumeration	2

element **Altre_Detrazioni_Type/Importo**

diagram	
namespace	urn:www.agenziaentrate.gov.it:specificheTecniche:sco:730
type	DatoNP_Type
facets	Kind Value pattern [1-9]{1}[0-9]*

complexType **Altre_Ritenute_Type**

diagram	
namespace	urn:www.agenziaentrate.gov.it:specificheTecniche:sco:730
children	m730:Codice m730:AltreRitenuteIrpef m730:AddizionaleRegionale m730:AddizionaleComunale m730:AddRegionaleIrpefAttivitaSport m730:AddComunaleIrpefAttivitaSport m730:IrpefLavoriSocialmenteUtili m730:AddRegionaleIrpefLavoriSoc Utili

element **Altre_Ritenute_Type/Codice**

diagram	
namespace	urn:www.agenziaentrate.gov.it:specificheTecniche:sco:730
type	restriction of DatoN1_Type
facets	Kind Value pattern [1-9] enumeration 1 enumeration 2

element **Altre_Ritenute_Type/AltreRitenuteIrpef**

diagram	
namespace	urn:www.agenziaentrate.gov.it:specificheTecniche:sco:730
type	DatoNP_Type
facets	Kind Value pattern [1-9]{1}[0-9]*

element **Altre_Ritenute_Type/AddizionaleRegionale**

diagram	
namespace	urn:www.agenziaentrate.gov.it:specificheTecniche:sco:730
type	DatoNP_Type
facets	Kind Value pattern [1-9]{1}[0-9]*

element **Altre_Ritenute_Type/AddizionaleComunale**

diagram	
namespace	urn:www.agenziaentrate.gov.it:specificheTecniche:sco:730
type	DatoNP_Type
facets	Kind Value pattern [1-9]{1}[0-9]*

element **Altre_Ritenute_Type/AddRegionaleIrpefAttivitaSport**

diagram	
namespace	urn:www.agenziaentrate.gov.it:specificheTecniche:sco:730
type	DatoNP_Type
facets	Kind Value pattern [1-9]{1}[0-9]*

element **Altre_Ritenute_Type/AddComunaleIrpefAttivitaSport**

diagram	
namespace	urn:www.agenziaentrate.gov.it:specificheTecniche:sco:730
type	DatoNP_Type
facets	Kind Value pattern [1-9]{1}[0-9]*

element **Altre_Ritenute_Type/IrpefLavoriSocialmenteUtili**

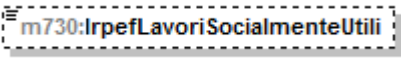
diagram	
namespace	urn:www.agenziaentrate.gov.it:specificheTecniche:sco:730
type	DatoNP_Type
facets	Kind Value pattern [1-9]{1}[0-9]*

element **Altre_Ritenute_Type/AddRegionaleIrpefLavoriSoc_Utili**

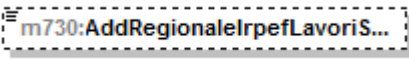
diagram	
namespace	urn:www.agenziaentrate.gov.it:specificheTecniche:sco:730
type	DatoNP_Type
facets	Kind Value pattern [1-9]{1}[0-9]*

complexType **Altre_Spese_Type**

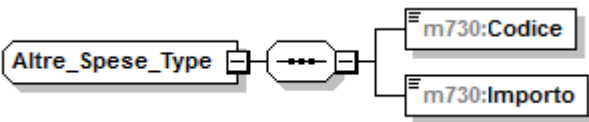
diagram	
namespace	urn:www.agenziaentrate.gov.it:specificheTecniche:sco:730
children	m730:Codice m730:Importo

element **Altre_Spese_Type/Codice**

diagram	
namespace	urn:www.agenziaentrate.gov.it:specificheTecniche:sco:730
type	restriction of m730:Codice Altre_Spese_Type
facets	Kind Value pattern [1-9]{1}[0-9]* enumeration 8 enumeration 9 enumeration 10 enumeration 11 enumeration 12 enumeration 13 enumeration 14 enumeration 15 enumeration 16 enumeration 17 enumeration 18 enumeration 20

enumeration	21
enumeration	22
enumeration	23
enumeration	24
enumeration	25
enumeration	26
enumeration	27
enumeration	28
enumeration	29
enumeration	30
enumeration	31
enumeration	32
enumeration	33
enumeration	35
enumeration	36
enumeration	38
enumeration	39
enumeration	41
enumeration	42
enumeration	99

element `Altre_Spese_Type/Importo`

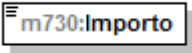
diagram					
namespace	urn:www.agenziaentrate.gov.it:specificheTecniche:sco:730				
type	DatoNP_Type				
facets	<table border="1"> <thead> <tr> <th>Kind</th> <th>Value</th> </tr> </thead> <tbody> <tr> <td>pattern</td> <td>[1-9]{1}[0-9]*</td> </tr> </tbody> </table>	Kind	Value	pattern	[1-9]{1}[0-9]*
Kind	Value				
pattern	[1-9]{1}[0-9]*				

complexType Altri_Dati_Type

<p>diagram</p>	
<p>namespace</p>	<p>urn:www.agenziaentrate.gov.it:specificheTecniche:sco:730</p>
<p>children</p>	<p>m730:ResiduoCreditoErogazioneCultura m730:ResiduoCreditoPrimaCasa m730:ResiduoCreditoOccupazione m730:ResiduoCreditoSisma m730:ResiduoCreditoFondiPensione m730:ResiduoCreditoMediazioni m730:TotSpeseSanitarieRateizzate m730:RedditoAgevolazioniFiscali m730:RedditoComplessivoAcconto m730:RigoDifferenzaAcconto m730:AccontiCompensatiIntern m730:RedditiFondariNonImponibili m730:RedditoAbitazionePrincipalePertinenze m730:ResiduoDeduzioneSommeRestituite m730:ResiduoErogazioniScuola m730:ResiduoCreditoNegoziazione m730:ResiduoCreditoVideosorveglianza m730:CreditoErogazioneCultura</p>

element Altri_Dati_Type/ResiduoCreditoErogazioneCultura

<p>diagram</p>	
----------------	--

namespace	urn:www.agenziaentrate.gov.it:specificheTecniche:sco:730
type	DatoNP_Type
facets	Kind Value pattern [1-9]{1}[0-9]*

element Altri_Dati_Type/ResiduoCreditoPrimaCasa

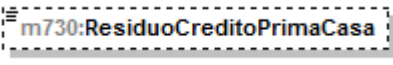
diagram	
namespace	urn:www.agenziaentrate.gov.it:specificheTecniche:sco:730
type	DatoNP_Type
facets	Kind Value pattern [1-9]{1}[0-9]*

element Altri_Dati_Type/ResiduoCreditoOccupazione

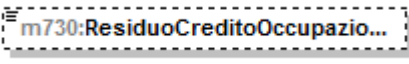
diagram	
namespace	urn:www.agenziaentrate.gov.it:specificheTecniche:sco:730
type	DatoNP_Type
facets	Kind Value pattern [1-9]{1}[0-9]*

element Altri_Dati_Type/ResiduoCreditoSisma

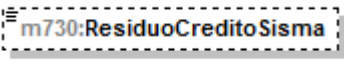
diagram	
namespace	urn:www.agenziaentrate.gov.it:specificheTecniche:sco:730
type	DatoNP_Type
facets	Kind Value pattern [1-9]{1}[0-9]*

element Altri_Dati_Type/ResiduoCreditoFondiPensione

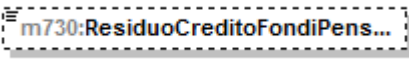
diagram	
namespace	urn:www.agenziaentrate.gov.it:specificheTecniche:sco:730
type	DatoNP_Type
facets	Kind Value pattern [1-9]{1}[0-9]*

element **Altri_Dati_Type/ResiduoCreditoMediazioni**

diagram	 m730:ResiduoCreditoMediazioni
namespace	urn:www.agenziaentrate.gov.it:specificheTecniche:sco:730
type	DatoNP_Type
facets	Kind Value pattern [1-9]{1}[0-9]*

element **Altri_Dati_Type/TotSpeseSanitarieRateizzate**

diagram	 m730:TotSpeseSanitarieRateizza...
namespace	urn:www.agenziaentrate.gov.it:specificheTecniche:sco:730
type	DatoNP_Type
facets	Kind Value pattern [1-9]{1}[0-9]*

element **Altri_Dati_Type/RedditoAgevolazioniFiscali**

diagram	 m730:RedditoAgevolazioniFiscali
namespace	urn:www.agenziaentrate.gov.it:specificheTecniche:sco:730
type	DatoNP_Type
facets	Kind Value pattern [1-9]{1}[0-9]*

element **Altri_Dati_Type/RedditoComplessivoAcconto**

diagram	 m730:RedditoComplessivoAcco...
namespace	urn:www.agenziaentrate.gov.it:specificheTecniche:sco:730
type	DatoNP_Type
facets	Kind Value pattern [1-9]{1}[0-9]*

element **Altri_Dati_Type/RigoDifferenzaAcconto**

diagram	 m730:RigoDifferenzaAcconto
namespace	urn:www.agenziaentrate.gov.it:specificheTecniche:sco:730
type	DatoNU_Type
facets	Kind Value pattern (\-[1-9] [1-9])[0-9]*

element Altri_Dati_Type/AccontiCompensatiIntern

diagram	<pre> classDiagram class m730AccontiCompensatiIntern class m730Acoonti_Compensati_Intern_Type { m730PrimaRatalrpef m730AddizionaleComunale m730PrimaRataCedolare } m730AccontiCompensatiIntern -- m730Acoonti_Compensati_Intern_Type </pre>
namespace	urn:www.agenziaentrate.gov.it:specificheTecniche:sco:730
type	m730:Acoonti_Compensati_Intern_Type
children	m730:PrimaRatalrpef m730:AddizionaleComunale m730:PrimaRataCedolare

element Altri_Dati_Type/RedditiFondariNonImponibili

diagram	<pre> classDiagram class m730RedditiFondariNonImponibili </pre>				
namespace	urn:www.agenziaentrate.gov.it:specificheTecniche:sco:730				
type	DatoNP_Type				
facets	<table border="1"> <thead> <tr> <th>Kind</th> <th>Value</th> </tr> </thead> <tbody> <tr> <td>pattern</td> <td>[1-9]{1}[0-9]*</td> </tr> </tbody> </table>	Kind	Value	pattern	[1-9]{1}[0-9]*
Kind	Value				
pattern	[1-9]{1}[0-9]*				

element Altri_Dati_Type/RedditoAbitazionePrincipalePertinenze

diagram	<pre> classDiagram class m730RedditoAbitazionePrincipalePertinenze </pre>				
namespace	urn:www.agenziaentrate.gov.it:specificheTecniche:sco:730				
type	DatoNP_Type				
facets	<table border="1"> <thead> <tr> <th>Kind</th> <th>Value</th> </tr> </thead> <tbody> <tr> <td>pattern</td> <td>[1-9]{1}[0-9]*</td> </tr> </tbody> </table>	Kind	Value	pattern	[1-9]{1}[0-9]*
Kind	Value				
pattern	[1-9]{1}[0-9]*				

element Altri_Dati_Type/ResiduoDeduzioneSommeRestituite

diagram	<pre> classDiagram class m730ResiduoDeduzioneSommeRestituite </pre>				
namespace	urn:www.agenziaentrate.gov.it:specificheTecniche:sco:730				
type	DatoNP_Type				
facets	<table border="1"> <thead> <tr> <th>Kind</th> <th>Value</th> </tr> </thead> <tbody> <tr> <td>pattern</td> <td>[1-9]{1}[0-9]*</td> </tr> </tbody> </table>	Kind	Value	pattern	[1-9]{1}[0-9]*
Kind	Value				
pattern	[1-9]{1}[0-9]*				

element **Altri_Dati_Type/ResiduoErogazioniScuola**

diagram	
namespace	urn:www.agenziaentrate.gov.it:specificheTecniche:sco:730
type	DatoNP_Type
facets	Kind Value pattern [1-9]{1}[0-9]*

element **Altri_Dati_Type/ResiduoCreditoNegoziazione**

diagram	
namespace	urn:www.agenziaentrate.gov.it:specificheTecniche:sco:730
type	DatoNP_Type
facets	Kind Value pattern [1-9]{1}[0-9]*

element **Altri_Dati_Type/ResiduoCreditoVideosorveglianza**

diagram	
namespace	urn:www.agenziaentrate.gov.it:specificheTecniche:sco:730
type	DatoNP_Type
facets	Kind Value pattern [1-9]{1}[0-9]*

element **Altri_Dati_Type/CreditoErogazioneCultura**

diagram	
namespace	urn:www.agenziaentrate.gov.it:specificheTecniche:sco:730
type	m730:Cred_Erogazione_Cultura_Type
children	m730:RataAnnoPrec m730:RataAnno

complexType **Altri_Oneri_Type**

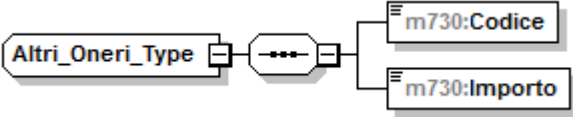
diagram	
namespace	urn:www.agenziaentrate.gov.it:specificheTecniche:sco:730
children	m730:Codice m730:Importo

element **Altri_Oneri_Type/Codice**

diagram																			
namespace	urn:www.agenziaentrate.gov.it:specificheTecniche:sco:730																		
type	m730:Codice_Altri_Oneri_Type																		
facets	<table border="1"> <thead> <tr> <th>Kind</th> <th>Value</th> </tr> </thead> <tbody> <tr> <td>pattern</td> <td>[1-9]{1}[0-9]*</td> </tr> <tr> <td>enumeration</td> <td>6</td> </tr> <tr> <td>enumeration</td> <td>7</td> </tr> <tr> <td>enumeration</td> <td>8</td> </tr> <tr> <td>enumeration</td> <td>9</td> </tr> <tr> <td>enumeration</td> <td>12</td> </tr> <tr> <td>enumeration</td> <td>13</td> </tr> <tr> <td>enumeration</td> <td>21</td> </tr> </tbody> </table>	Kind	Value	pattern	[1-9]{1}[0-9]*	enumeration	6	enumeration	7	enumeration	8	enumeration	9	enumeration	12	enumeration	13	enumeration	21
Kind	Value																		
pattern	[1-9]{1}[0-9]*																		
enumeration	6																		
enumeration	7																		
enumeration	8																		
enumeration	9																		
enumeration	12																		
enumeration	13																		
enumeration	21																		

element **Altri_Oneri_Type/Importo**

diagram					
namespace	urn:www.agenziaentrate.gov.it:specificheTecniche:sco:730				
type	DatoNP_Type				
facets	<table border="1"> <thead> <tr> <th>Kind</th> <th>Value</th> </tr> </thead> <tbody> <tr> <td>pattern</td> <td>[1-9]{1}[0-9]*</td> </tr> </tbody> </table>	Kind	Value	pattern	[1-9]{1}[0-9]*
Kind	Value				
pattern	[1-9]{1}[0-9]*				

complexType **Altri_Reddito_Ass_Lav_Type**

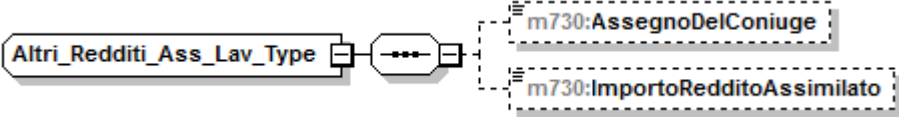
diagram	
namespace	urn:www.agenziaentrate.gov.it:specificheTecniche:sco:730
children	m730:AssegnoDelConiuge m730:ImportoRedditoAssimilato

element **Altri_Reddito_Ass_Lav_Type/AssegnoDelConiuge**

diagram	
---------	---

namespace	urn:www.agenziaentrate.gov.it:specificheTecniche:sco:730
type	DatoCB_Type
facets	Kind Value pattern [01]

element Altri_Redditi_Ass_Lav_Type/ImportoRedditoAssimilato

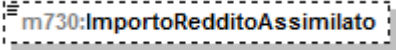
diagram	
namespace	urn:www.agenziaentrate.gov.it:specificheTecniche:sco:730
type	DatoNP_Type
facets	Kind Value pattern [1-9]{1}[0-9]*

complexType Altri_Redditi_Diversi_Detr_Type

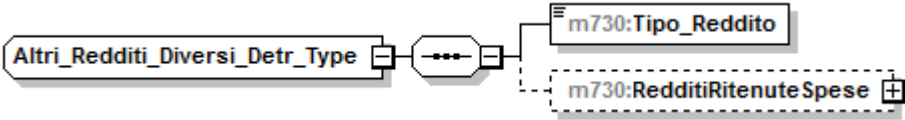
diagram	
namespace	urn:www.agenziaentrate.gov.it:specificheTecniche:sco:730
children	m730:Tipo_Reddito m730:RedditiRitenuteSpese

element Altri_Redditi_Diversi_Detr_Type/Tipo_Reddito

diagram	
namespace	urn:www.agenziaentrate.gov.it:specificheTecniche:sco:730
type	m730:Tipo_Reddito_Da1a4_Type
facets	Kind Value pattern [1-9] enumeration 1 enumeration 2 enumeration 3 enumeration 4

element **Altri_Reddito_Diversi_Detr_Type/RedditoRitenuteSpese**

diagram	
namespace	urn:www.agenziaentrate.gov.it:specificheTecniche:sco:730
type	m730:RedditoRitenuteSpese_Type
children	m730:ImportoReddito m730:ImportoRitenute m730:ImportoSpese

complexType **Altri_Reddito_Diversi_Type**

diagram	
namespace	urn:www.agenziaentrate.gov.it:specificheTecniche:sco:730
children	m730:TipoReddito m730:RedditoRitenuteSpese

element **Altri_Reddito_Diversi_Type/TipoReddito**

diagram																							
namespace	urn:www.agenziaentrate.gov.it:specificheTecniche:sco:730																						
type	m730:TipoReddito_Da1a9_Type																						
facets	<table border="1"> <thead> <tr> <th>Kind</th> <th>Value</th> </tr> </thead> <tbody> <tr> <td>pattern</td> <td>[1-9]{1}[0-9]*</td> </tr> <tr> <td>enumeration</td> <td>1</td> </tr> <tr> <td>enumeration</td> <td>2</td> </tr> <tr> <td>enumeration</td> <td>3</td> </tr> <tr> <td>enumeration</td> <td>4</td> </tr> <tr> <td>enumeration</td> <td>5</td> </tr> <tr> <td>enumeration</td> <td>6</td> </tr> <tr> <td>enumeration</td> <td>7</td> </tr> <tr> <td>enumeration</td> <td>8</td> </tr> <tr> <td>enumeration</td> <td>9</td> </tr> </tbody> </table>	Kind	Value	pattern	[1-9]{1}[0-9]*	enumeration	1	enumeration	2	enumeration	3	enumeration	4	enumeration	5	enumeration	6	enumeration	7	enumeration	8	enumeration	9
Kind	Value																						
pattern	[1-9]{1}[0-9]*																						
enumeration	1																						
enumeration	2																						
enumeration	3																						
enumeration	4																						
enumeration	5																						
enumeration	6																						
enumeration	7																						
enumeration	8																						
enumeration	9																						

element **Altri_Reddi_Diversi_Type/ReddiRitenuteSpese**

diagram	
namespace	urn:www.agenziaentrate.gov.it:specificheTecniche:sco:730
type	m730:Reddi_Ritenute_Spese_Type
children	m730:ImportoReddi m730:ImportoRitenute m730:ImportoSpese

complexType **Altri_Reddi_Lavoro_Autonomo_Type**

diagram	
namespace	urn:www.agenziaentrate.gov.it:specificheTecniche:sco:730
children	m730:TipoReddito m730:ReddiRitenute

element **Altri_Reddi_Lavoro_Autonomo_Type/TipoReddito**

diagram											
namespace	urn:www.agenziaentrate.gov.it:specificheTecniche:sco:730										
type	m730:Tipo_Reddito_Da1a3_Type										
facets	<table border="1"> <thead> <tr> <th>Kind</th> <th>Value</th> </tr> </thead> <tbody> <tr> <td>pattern</td> <td>[1-9]</td> </tr> <tr> <td>enumeration</td> <td>1</td> </tr> <tr> <td>enumeration</td> <td>2</td> </tr> <tr> <td>enumeration</td> <td>3</td> </tr> </tbody> </table>	Kind	Value	pattern	[1-9]	enumeration	1	enumeration	2	enumeration	3
Kind	Value										
pattern	[1-9]										
enumeration	1										
enumeration	2										
enumeration	3										

element **Altri_Reddi_Lavoro_Autonomo_Type/ReddiRitenute**

diagram	
namespace	urn:www.agenziaentrate.gov.it:specificheTecniche:sco:730

type	m730:Redditi Ritenute Type
children	m730:ImportoRedditi m730:ImportoRitenute

complexType Altri_Redditi_Type

diagram	
namespace	urn:www.agenziaentrate.gov.it:specificheTecniche:sco:730
children	m730:Modulo

element Altri_Redditi_Type/Modulo

diagram	
namespace	urn:www.agenziaentrate.gov.it:specificheTecniche:sco:730
type	m730:Modulo_Altri_Redditi_Type
children	m730:RedditiDiCapitale m730:RedditiTassazioneSeparata

complexType Altri_Redditi_Utili_Type

diagram	
namespace	urn:www.agenziaentrate.gov.it:specificheTecniche:sco:730
children	m730:Tipo_Reddito m730:RedditiRitenute

element Altri_Redditi_Utili_Type/Tipo_Reddito

diagram											
namespace	urn:www.agenziaentrate.gov.it:specificheTecniche:sco:730										
type	m730:Tipo_Reddito Da1a8 Type										
facets	<table border="1"> <thead> <tr> <th>Kind</th> <th>Value</th> </tr> </thead> <tbody> <tr> <td>pattern</td> <td>[1-9]{1}[0-9]*</td> </tr> <tr> <td>enumeration</td> <td>1</td> </tr> <tr> <td>enumeration</td> <td>2</td> </tr> <tr> <td>enumeration</td> <td>3</td> </tr> </tbody> </table>	Kind	Value	pattern	[1-9]{1}[0-9]*	enumeration	1	enumeration	2	enumeration	3
Kind	Value										
pattern	[1-9]{1}[0-9]*										
enumeration	1										
enumeration	2										
enumeration	3										

type	DatoNP_Type
facets	Kind Value pattern [1-9]{1}[0-9]*

element **Annotazione_Type/ModuloQuadro**

diagram	
namespace	urn:www.agenziaentrate.gov.it:specificheTecniche:sco:730
type	DatoNP_Type
facets	Kind Value pattern [1-9]{1}[0-9]*

element **Annotazione_Type/Importo**

diagram	
namespace	urn:www.agenziaentrate.gov.it:specificheTecniche:sco:730
type	DatoNP_Type
facets	Kind Value pattern [1-9]{1}[0-9]*

complexType **Assegno_Coniuge_Type**

diagram	
namespace	urn:www.agenziaentrate.gov.it:specificheTecniche:sco:730
children	m730:CodiceFiscale m730:Importo

element **Assegno_Coniuge_Type/CodiceFiscale**

diagram	
namespace	urn:www.agenziaentrate.gov.it:specificheTecniche:sco:730
type	DatoCF_Type
facets	Kind Value pattern [0-9]{11}[A-Z]{6}[0-9LMNPQRSTU]{2}[A-Z]{1}[0-9LMNPQRSTU]{2}[A-Z]{1}[0-9LMNPQRSTU]{3}[A-Z]{1}

element **Assegno_Coniuge_Type/Importo**

diagram	
---------	--

namespace	urn:www.agenziaentrate.gov.it:specificheTecniche:sco:730
type	DatoNP_Type
facets	Kind Value pattern [1-9]{1}[0-9]*

complexType Bonus_Irpef_Type

diagram	
namespace	urn:www.agenziaentrate.gov.it:specificheTecniche:sco:730
children	m730:CodiceBonus m730:BonusErogato m730:Esenzione m730:QuotaTfr

element Bonus_Irpef_Type/CodiceBonus

diagram	
namespace	urn:www.agenziaentrate.gov.it:specificheTecniche:sco:730
type	restriction of DatoN1_Type
facets	Kind Value pattern [1-9] enumeration 1 enumeration 2

element Bonus_Irpef_Type/BonusErogato

diagram	
namespace	urn:www.agenziaentrate.gov.it:specificheTecniche:sco:730
type	DatoNP_Type
facets	Kind Value pattern [1-9]{1}[0-9]*

element **Bonus_Irpef_Type/Esenzione**

diagram	
namespace	urn:www.agenziaentrate.gov.it:specificheTecniche:sco:730
type	m730:Esenzione_Bonus_Type
children	m730:TipologiaEsenzione m730:ParteRedditoEsente

element **Bonus_Irpef_Type/QuotaTfr**

diagram					
namespace	urn:www.agenziaentrate.gov.it:specificheTecniche:sco:730				
type	DatoNP_Type				
facets	<table border="1"> <tr> <td>Kind</td> <td>Value</td> </tr> <tr> <td>pattern</td> <td>[1-9]{1}[0-9]*</td> </tr> </table>	Kind	Value	pattern	[1-9]{1}[0-9]*
Kind	Value				
pattern	[1-9]{1}[0-9]*				

complexType **Casella_Acconto_Type**

diagram	
namespace	urn:www.agenziaentrate.gov.it:specificheTecniche:sco:730
children	m730:Casella m730:ImportoMisuralInferiore

element **Casella_Acconto_Type/Casella**

diagram					
namespace	urn:www.agenziaentrate.gov.it:specificheTecniche:sco:730				
type	DatoCB_Type				
facets	<table border="1"> <tr> <td>Kind</td> <td>Value</td> </tr> <tr> <td>pattern</td> <td>[01]</td> </tr> </table>	Kind	Value	pattern	[01]
Kind	Value				
pattern	[01]				

element **Casella_Acconto_Type/ImportoMisuralInferiore**

diagram	
---------	--

namespace	urn:www.agenziaentrate.gov.it:specificheTecniche:sco:730
type	DatoNP_Type
facets	Kind Value pattern [1-9]{1}[0-9]*

complexType Cedolare_Secca_Type

diagram	
namespace	urn:www.agenziaentrate.gov.it:specificheTecniche:sco:730
children	m730:CedolareDovuta m730:EccedenzaCedolareSecca m730:AccontoCedolare

element Cedolare_Secca_Type/CedolareDovuta

diagram	
namespace	urn:www.agenziaentrate.gov.it:specificheTecniche:sco:730
type	DatoNP_Type
facets	Kind Value pattern [1-9]{1}[0-9]*

element Cedolare_Secca_Type/EccedenzaCedolareSecca

diagram	
namespace	urn:www.agenziaentrate.gov.it:specificheTecniche:sco:730
type	DatoNU_Type
facets	Kind Value pattern (\-[1-9] [1-9])[0-9]*

element Cedolare_Secca_Type/AccontoCedolare

diagram	
namespace	urn:www.agenziaentrate.gov.it:specificheTecniche:sco:730
type	DatoNP_Type
facets	Kind Value pattern [1-9]{1}[0-9]*

complexType **Comunicazione_Amministratore_Type**

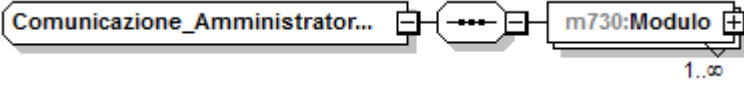
diagram	
namespace	urn:www.agenziaentrate.gov.it:specificheTecniche:sco:730
children	m730:Modulo

element **Comunicazione_Amministratore_Type/Modulo**

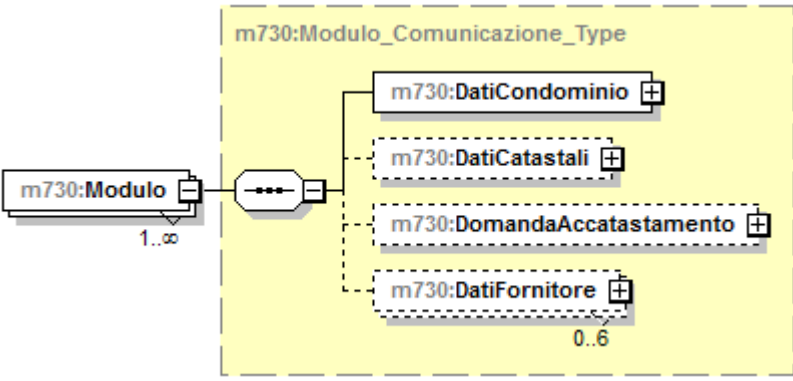
diagram	
namespace	urn:www.agenziaentrate.gov.it:specificheTecniche:sco:730
type	m730:Modulo_Comunicazione_Type
children	m730:DatiCondominio m730:DatiCatastali m730:DomandaAccatastamento m730:DatiFornitore

complexType **Conguaglio_Type**

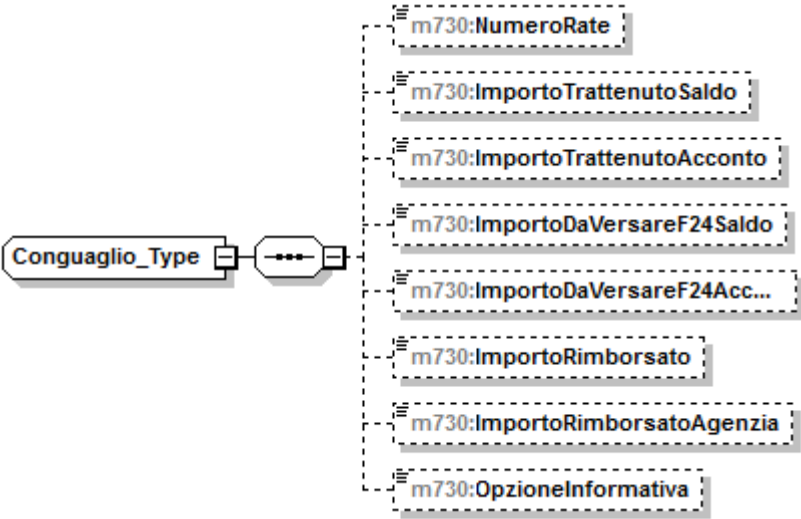
diagram	
namespace	urn:www.agenziaentrate.gov.it:specificheTecniche:sco:730
children	m730:NumeroRate m730:ImportoTrattenutoSaldo m730:ImportoTrattenutoAcconto m730:ImportoDaVersareF24Saldo m730:ImportoDaVersareF24Acconto m730:ImportoRimborsato m730:ImportoRimborsatoAgenzia m730:OpzioneInformativa

	m730:ImportoRimborsatoAgenzia m730:OpzioneInformativa
--	---

element **Conguaglio_Type/NumeroRate**

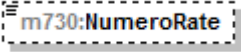
diagram																	
namespace	urn:www.agenziaentrate.gov.it:specificheTecniche:sco:730																
type	restriction of DatoN1_Type																
facets	<table border="1"> <thead> <tr> <th>Kind</th> <th>Value</th> </tr> </thead> <tbody> <tr> <td>pattern</td> <td>[1-9]</td> </tr> <tr> <td>enumeration</td> <td>2</td> </tr> <tr> <td>enumeration</td> <td>3</td> </tr> <tr> <td>enumeration</td> <td>4</td> </tr> <tr> <td>enumeration</td> <td>5</td> </tr> <tr> <td>enumeration</td> <td>6</td> </tr> <tr> <td>enumeration</td> <td>7</td> </tr> </tbody> </table>	Kind	Value	pattern	[1-9]	enumeration	2	enumeration	3	enumeration	4	enumeration	5	enumeration	6	enumeration	7
Kind	Value																
pattern	[1-9]																
enumeration	2																
enumeration	3																
enumeration	4																
enumeration	5																
enumeration	6																
enumeration	7																

element **Conguaglio_Type/ImportoTrattenutoSaldo**

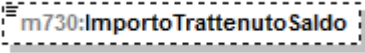
diagram					
namespace	urn:www.agenziaentrate.gov.it:specificheTecniche:sco:730				
type	DatoNP_Type				
facets	<table border="1"> <thead> <tr> <th>Kind</th> <th>Value</th> </tr> </thead> <tbody> <tr> <td>pattern</td> <td>[1-9]{1}[0-9]*</td> </tr> </tbody> </table>	Kind	Value	pattern	[1-9]{1}[0-9]*
Kind	Value				
pattern	[1-9]{1}[0-9]*				

element **Conguaglio_Type/ImportoTrattenutoAcconto**

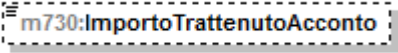
diagram					
namespace	urn:www.agenziaentrate.gov.it:specificheTecniche:sco:730				
type	DatoNP_Type				
facets	<table border="1"> <thead> <tr> <th>Kind</th> <th>Value</th> </tr> </thead> <tbody> <tr> <td>pattern</td> <td>[1-9]{1}[0-9]*</td> </tr> </tbody> </table>	Kind	Value	pattern	[1-9]{1}[0-9]*
Kind	Value				
pattern	[1-9]{1}[0-9]*				

element **Conguaglio_Type/ImportoDaVersareF24Saldo**

diagram					
namespace	urn:www.agenziaentrate.gov.it:specificheTecniche:sco:730				
type	DatoNP_Type				
facets	<table border="1"> <thead> <tr> <th>Kind</th> <th>Value</th> </tr> </thead> <tbody> <tr> <td>pattern</td> <td>[1-9]{1}[0-9]*</td> </tr> </tbody> </table>	Kind	Value	pattern	[1-9]{1}[0-9]*
Kind	Value				
pattern	[1-9]{1}[0-9]*				

element **Conguaglio_Type/ImportoDaVersareF24Acconto**

diagram					
namespace	urn:www.agenziaentrate.gov.it:specificheTecniche:sco:730				
type	DatoNP_Type				
facets	<table border="1"> <tr> <td>Kind</td> <td>Value</td> </tr> <tr> <td>pattern</td> <td>[1-9]{1}[0-9]*</td> </tr> </table>	Kind	Value	pattern	[1-9]{1}[0-9]*
Kind	Value				
pattern	[1-9]{1}[0-9]*				

element **Conguaglio_Type/ImportoRimborsato**

diagram					
namespace	urn:www.agenziaentrate.gov.it:specificheTecniche:sco:730				
type	DatoNP_Type				
facets	<table border="1"> <tr> <td>Kind</td> <td>Value</td> </tr> <tr> <td>pattern</td> <td>[1-9]{1}[0-9]*</td> </tr> </table>	Kind	Value	pattern	[1-9]{1}[0-9]*
Kind	Value				
pattern	[1-9]{1}[0-9]*				

element **Conguaglio_Type/ImportoRimborsatoAgenzia**

diagram					
namespace	urn:www.agenziaentrate.gov.it:specificheTecniche:sco:730				
type	DatoNP_Type				
facets	<table border="1"> <tr> <td>Kind</td> <td>Value</td> </tr> <tr> <td>pattern</td> <td>[1-9]{1}[0-9]*</td> </tr> </table>	Kind	Value	pattern	[1-9]{1}[0-9]*
Kind	Value				
pattern	[1-9]{1}[0-9]*				

element **Conguaglio_Type/OpzioneInformativa**

diagram					
namespace	urn:www.agenziaentrate.gov.it:specificheTecniche:sco:730				
type	DatoCB_Type				
facets	<table border="1"> <tr> <td>Kind</td> <td>Value</td> </tr> <tr> <td>pattern</td> <td>[01]</td> </tr> </table>	Kind	Value	pattern	[01]
Kind	Value				
pattern	[01]				

complexType **Contributi_Previdenza_Complementare_Type**

diagram	
namespace	urn:www.agenziaentrate.gov.it:specificheTecniche:sco:730
children	m730:EsclusiDalSostituto m730:NonEsclusiDalSostituto

element **Contributi_Previdenza_Complementare_Type/EsclusiDalSostituto**

diagram	
namespace	urn:www.agenziaentrate.gov.it:specificheTecniche:sco:730
type	DatoNP_Type
facets	Kind Value pattern [1-9]{1}[0-9]*

element **Contributi_Previdenza_Complementare_Type/NonEsclusiDalSostituto**

diagram	
namespace	urn:www.agenziaentrate.gov.it:specificheTecniche:sco:730
type	DatoNP_Type
facets	Kind Value pattern [1-9]{1}[0-9]*

complexType **Contributo_Solidarieta_Type**

diagram	
namespace	urn:www.agenziaentrate.gov.it:specificheTecniche:sco:730
children	m730:ImponibileContributo m730:ContributoDovuto m730:ContributoCertificaz

element **Contributo_Solidarieta_Type/ImponibileContributo**

diagram	
namespace	urn:www.agenziaentrate.gov.it:specificheTecniche:sco:730
type	DatoNP_Type
facets	Kind Value pattern [1-9]{1}[0-9]*

element **Contributo_Solidarieta_Type/ContributoDovuto**

diagram	
namespace	urn:www.agenziaentrate.gov.it:specificheTecniche:sco:730

type	DatoNP_Type
facets	Kind Value pattern [1-9]{1}[0-9]*

element **Contributo_Solidarieta_Type/ContributoCertificaz**

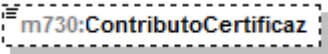
diagram	
namespace	urn:www.agenziaentrate.gov.it:specificheTecniche:sco:730
type	DatoNP_Type
facets	Kind Value pattern [1-9]{1}[0-9]*

complexType **Cred_Erogazione_Cultura_Type**

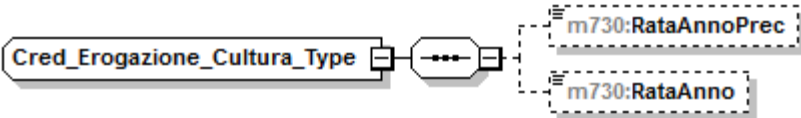
diagram	
namespace	urn:www.agenziaentrate.gov.it:specificheTecniche:sco:730
children	m730:RataAnnoPrec m730:RataAnno

element **Cred_Erogazione_Cultura_Type/RataAnnoPrec**

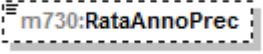
diagram	
namespace	urn:www.agenziaentrate.gov.it:specificheTecniche:sco:730
type	DatoNP_Type
facets	Kind Value pattern [1-9]{1}[0-9]*

element **Cred_Erogazione_Cultura_Type/RataAnno**

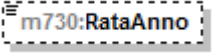
diagram	
namespace	urn:www.agenziaentrate.gov.it:specificheTecniche:sco:730
type	DatoNP_Type
facets	Kind Value pattern [1-9]{1}[0-9]*

complexType Cred_Imp_Estero_Type

diagram	
namespace	urn:www.agenziaentrate.gov.it:specificheTecniche:sco:730
children	m730:Anno m730:TotCredito m730:CreditoStato

element Cred_Imp_Estero_Type/Anno

diagram					
namespace	urn:www.agenziaentrate.gov.it:specificheTecniche:sco:730				
type	DatoDA_Type				
facets	<table border="1"> <thead> <tr> <th>Kind</th> <th>Value</th> </tr> </thead> <tbody> <tr> <td>pattern</td> <td>(18 19 20)[0-9]{2}</td> </tr> </tbody> </table>	Kind	Value	pattern	(18 19 20)[0-9]{2}
Kind	Value				
pattern	(18 19 20)[0-9]{2}				

element Cred_Imp_Estero_Type/TotCredito

diagram					
namespace	urn:www.agenziaentrate.gov.it:specificheTecniche:sco:730				
type	DatoNP_Type				
facets	<table border="1"> <thead> <tr> <th>Kind</th> <th>Value</th> </tr> </thead> <tbody> <tr> <td>pattern</td> <td>[1-9]{1}[0-9]*</td> </tr> </tbody> </table>	Kind	Value	pattern	[1-9]{1}[0-9]*
Kind	Value				
pattern	[1-9]{1}[0-9]*				

element Cred_Imp_Estero_Type/CreditoStato

diagram	
namespace	urn:www.agenziaentrate.gov.it:specificheTecniche:sco:730
type	m730:Credito Stato_Type
children	m730:Stato m730:Credito

complexType **Crediti_F24_Type**

diagram	
namespace	urn:www.agenziaentrate.gov.it:specificheTecniche:sco:730
children	m730:Credlrpef m730:CredlrpefDipNoSostituto m730:CodAddReg m730:CredAddReg m730:CredAddRegDipNoSostituto m730:CodiceAddCom m730:CredAddCom m730:CredAddComDipNoSostituto m730:CredCedolare m730:CredCedolareDipNoSostit... m730:CredTassSeparDipNoSosti... m730:CredImpostaSostDipNo So... m730:CredSolidarietaDipNoSosti... m730:Totale m730:TotaleDipNoSostituto

element **Crediti_F24_Type/Credlrpef**

diagram					
namespace	urn:www.agenziaentrate.gov.it:specificheTecniche:sco:730				
type	DatoNP_Type				
facets	<table border="1"> <tr> <td>Kind</td> <td>Value</td> </tr> <tr> <td>pattern</td> <td>[1-9]{1}[0-9]*</td> </tr> </table>	Kind	Value	pattern	[1-9]{1}[0-9]*
Kind	Value				
pattern	[1-9]{1}[0-9]*				

element **Crediti_F24_Type/CredIrpefDipNoSostituto**

diagram	 m730:CredIrpefDipNoSostituto				
namespace	urn:www.agenziaentrate.gov.it:specificheTecniche:sco:730				
type	DatoNP_Type				
facets	<table border="1"> <tr> <td>Kind</td> <td>Value</td> </tr> <tr> <td>pattern</td> <td>[1-9]{1}[0-9]*</td> </tr> </table>	Kind	Value	pattern	[1-9]{1}[0-9]*
Kind	Value				
pattern	[1-9]{1}[0-9]*				

element **Crediti_F24_Type/CodAddReg**

diagram	 m730:CodAddReg																																														
namespace	urn:www.agenziaentrate.gov.it:specificheTecniche:sco:730																																														
type	Codice_Regione_Type																																														
facets	<table border="1"> <tr> <td>Kind</td> <td>Value</td> </tr> <tr> <td>pattern</td> <td>([0-9A-Z\-\-] &quot;){1}([0-9A-Z&amp;:] \- \., / ° √ \(\) \) À È É Ì Ò Ù Û &quot; \ \\ \ +)*</td> </tr> <tr> <td>enumeration</td> <td>1</td> </tr> <tr> <td>enumeration</td> <td>2</td> </tr> <tr> <td>enumeration</td> <td>3</td> </tr> <tr> <td>enumeration</td> <td>4</td> </tr> <tr> <td>enumeration</td> <td>5</td> </tr> <tr> <td>enumeration</td> <td>6</td> </tr> <tr> <td>enumeration</td> <td>7</td> </tr> <tr> <td>enumeration</td> <td>8</td> </tr> <tr> <td>enumeration</td> <td>9</td> </tr> <tr> <td>enumeration</td> <td>10</td> </tr> <tr> <td>enumeration</td> <td>11</td> </tr> <tr> <td>enumeration</td> <td>12</td> </tr> <tr> <td>enumeration</td> <td>13</td> </tr> <tr> <td>enumeration</td> <td>14</td> </tr> <tr> <td>enumeration</td> <td>15</td> </tr> <tr> <td>enumeration</td> <td>16</td> </tr> <tr> <td>enumeration</td> <td>17</td> </tr> <tr> <td>enumeration</td> <td>18</td> </tr> <tr> <td>enumeration</td> <td>19</td> </tr> <tr> <td>enumeration</td> <td>20</td> </tr> <tr> <td>enumeration</td> <td>21</td> </tr> </table>	Kind	Value	pattern	([0-9A-Z\-\-] "){1}([0-9A-Z&:] \- \., / ° √ \(\) \) À È É Ì Ò Ù Û " \ \\ \ +)*	enumeration	1	enumeration	2	enumeration	3	enumeration	4	enumeration	5	enumeration	6	enumeration	7	enumeration	8	enumeration	9	enumeration	10	enumeration	11	enumeration	12	enumeration	13	enumeration	14	enumeration	15	enumeration	16	enumeration	17	enumeration	18	enumeration	19	enumeration	20	enumeration	21
Kind	Value																																														
pattern	([0-9A-Z\-\-] "){1}([0-9A-Z&:] \- \., / ° √ \(\) \) À È É Ì Ò Ù Û " \ \\ \ +)*																																														
enumeration	1																																														
enumeration	2																																														
enumeration	3																																														
enumeration	4																																														
enumeration	5																																														
enumeration	6																																														
enumeration	7																																														
enumeration	8																																														
enumeration	9																																														
enumeration	10																																														
enumeration	11																																														
enumeration	12																																														
enumeration	13																																														
enumeration	14																																														
enumeration	15																																														
enumeration	16																																														
enumeration	17																																														
enumeration	18																																														
enumeration	19																																														
enumeration	20																																														
enumeration	21																																														

element **Crediti_F24_Type/CredAddReg**

diagram	 m730:CredAddReg				
namespace	urn:www.agenziaentrate.gov.it:specificheTecniche:sco:730				
type	DatoNP_Type				
facets	<table border="1"> <tr> <td>Kind</td> <td>Value</td> </tr> <tr> <td>pattern</td> <td>[1-9]{1}[0-9]*</td> </tr> </table>	Kind	Value	pattern	[1-9]{1}[0-9]*
Kind	Value				
pattern	[1-9]{1}[0-9]*				

element **Crediti_F24_Type/CredAddRegDipNoSostituto**

diagram	 m730:CredAddRegDipNoSostituto
---------	---

namespace	urn:www.agenziaentrate.gov.it:specificheTecniche:sco:730
type	DatoNP_Type
facets	Kind Value pattern [1-9]{1}[0-9]*

element **Crediti_F24_Type/CodiceAddCom**

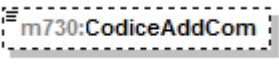
diagram	
namespace	urn:www.agenziaentrate.gov.it:specificheTecniche:sco:730
type	DatoAN_Type
facets	Kind Value pattern ([0-9A-Z\-_]\"){1}([0-9A-Z&:] " \- \., / "^\(\ \) À È Ì Ò Ù Û " \ \ /+)*

element **Crediti_F24_Type/CredAddCom**

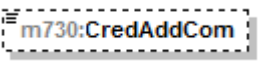
diagram	
namespace	urn:www.agenziaentrate.gov.it:specificheTecniche:sco:730
type	DatoNP_Type
facets	Kind Value pattern [1-9]{1}[0-9]*

element **Crediti_F24_Type/CredAddComDipNoSostituto**

diagram	
namespace	urn:www.agenziaentrate.gov.it:specificheTecniche:sco:730
type	DatoNP_Type
facets	Kind Value pattern [1-9]{1}[0-9]*

element **Crediti_F24_Type/CredCedolare**

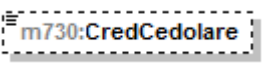
diagram	
namespace	urn:www.agenziaentrate.gov.it:specificheTecniche:sco:730
type	DatoNP_Type
facets	Kind Value pattern [1-9]{1}[0-9]*

element **Crediti_F24_Type/CredCedolareDipNoSostituto**

diagram	 m730:CredCedolareDipNoSostit...
namespace	urn:www.agenziaentrate.gov.it:specificheTecniche:sco:730
type	DatoNP_Type
facets	Kind Value pattern [1-9]{1}[0-9]*

element **Crediti_F24_Type/CredTassSeparDipNoSostituto**

diagram	 m730:CredTassSeparDipNoSosti...
namespace	urn:www.agenziaentrate.gov.it:specificheTecniche:sco:730
type	DatoNP_Type
facets	Kind Value pattern [1-9]{1}[0-9]*

element **Crediti_F24_Type/CredImpostaSostDipNoSostituto**

diagram	 m730:CredImpostaSostDipNoSo...
namespace	urn:www.agenziaentrate.gov.it:specificheTecniche:sco:730
type	DatoNP_Type
facets	Kind Value pattern [1-9]{1}[0-9]*

element **Crediti_F24_Type/CredSolidarietaDipNoSostituto**

diagram	 m730:CredSolidarietaDipNoSosti...
namespace	urn:www.agenziaentrate.gov.it:specificheTecniche:sco:730
type	DatoNP_Type
facets	Kind Value pattern [1-9]{1}[0-9]*

element **Crediti_F24_Type/Totale**

diagram	 m730:Totale
namespace	urn:www.agenziaentrate.gov.it:specificheTecniche:sco:730
type	DatoNP_Type
facets	Kind Value pattern [1-9]{1}[0-9]*

element **Crediti_F24_Type/TotaleDipNoSostituto**

diagram					
namespace	urn:www.agenziaentrate.gov.it:specificheTecniche:sco:730				
type	DatoNP_Type				
facets	<table border="1"> <tr> <td>Kind</td> <td>Value</td> </tr> <tr> <td>pattern</td> <td>[1-9]{1}[0-9]*</td> </tr> </table>	Kind	Value	pattern	[1-9]{1}[0-9]*
Kind	Value				
pattern	[1-9]{1}[0-9]*				

complexType **Crediti_Imposta_Altri_Sisma_Abruzzo_Type**

diagram	
namespace	urn:www.agenziaentrate.gov.it:specificheTecniche:sco:730
children	m730:Impresa_Professione m730:CreditoImmobileSismaAbruzzo m730:Rateazione

element **Crediti_Imposta_Altri_Sisma_Abruzzo_Type/Impresa_Professione**

diagram					
namespace	urn:www.agenziaentrate.gov.it:specificheTecniche:sco:730				
type	DatoCB_Type				
facets	<table border="1"> <tr> <td>Kind</td> <td>Value</td> </tr> <tr> <td>pattern</td> <td>[01]</td> </tr> </table>	Kind	Value	pattern	[01]
Kind	Value				
pattern	[01]				

element **Crediti_Imposta_Altri_Sisma_Abruzzo_Type/CreditoImmobileSismaAbruzzo**

diagram	
namespace	urn:www.agenziaentrate.gov.it:specificheTecniche:sco:730
type	m730:Credito_Immobil_Sisma_Abruzzo_Type
children	m730:CodiceFiscale m730:NumeroRata m730:TotaleCredito

element **Crediti Imposta Altri Sisma Abruzzo Type/Rateazione**

diagram									
namespace	urn:www.agenziaentrate.gov.it:specificheTecniche:sco:730								
type	restriction of DatoNP Type								
facets	<table border="1"> <thead> <tr> <th>Kind</th> <th>Value</th> </tr> </thead> <tbody> <tr> <td>pattern</td> <td>[1-9]{1}[0-9]*</td> </tr> <tr> <td>enumeration</td> <td>5</td> </tr> <tr> <td>enumeration</td> <td>10</td> </tr> </tbody> </table>	Kind	Value	pattern	[1-9]{1}[0-9]*	enumeration	5	enumeration	10
Kind	Value								
pattern	[1-9]{1}[0-9]*								
enumeration	5								
enumeration	10								

complexType **Crediti Imposta Fabbicati Type**

diagram	
namespace	urn:www.agenziaentrate.gov.it:specificheTecniche:sco:730
children	m730:ResiduoFabbicati m730:CanoniLocazioneNonPercepiti

element **Crediti Imposta Fabbicati Type/ResiduoFabbicati**

diagram	
namespace	urn:www.agenziaentrate.gov.it:specificheTecniche:sco:730
type	m730:Residuo Fabbicati Type
children	m730:ResiduoPrecedenteDichiarazione m730:CreditoAnno m730:DiCuiCompensatoF24

element **Crediti Imposta Fabbicati Type/CanoniLocazioneNonPercepiti**

diagram					
namespace	urn:www.agenziaentrate.gov.it:specificheTecniche:sco:730				
type	DatoNP Type				
facets	<table border="1"> <thead> <tr> <th>Kind</th> <th>Value</th> </tr> </thead> <tbody> <tr> <td>pattern</td> <td>[1-9]{1}[0-9]*</td> </tr> </tbody> </table>	Kind	Value	pattern	[1-9]{1}[0-9]*
Kind	Value				
pattern	[1-9]{1}[0-9]*				

complexType **Crediti_Imposta_Fondi_Pensione_Type**

diagram	
namespace	urn:www.agenziaentrate.gov.it:specificheTecniche:sco:730
children	m730:AnnoAnticipazione m730:Reintegro m730:SommaReintegrata m730:CreditoAnno

element **Crediti_Imposta_Fondi_Pensione_Type/AnnoAnticipazione**

diagram																									
namespace	urn:www.agenziaentrate.gov.it:specificheTecniche:sco:730																								
type	m730:Anno Anticipazione Fondo Pensione Type																								
facets	<table border="1"> <thead> <tr> <th>Kind</th> <th>Value</th> </tr> </thead> <tbody> <tr> <td>pattern</td> <td>[1-9]{1}[0-9]*</td> </tr> <tr> <td>enumeration</td> <td>2007</td> </tr> <tr> <td>enumeration</td> <td>2008</td> </tr> <tr> <td>enumeration</td> <td>2009</td> </tr> <tr> <td>enumeration</td> <td>2010</td> </tr> <tr> <td>enumeration</td> <td>2011</td> </tr> <tr> <td>enumeration</td> <td>2012</td> </tr> <tr> <td>enumeration</td> <td>2013</td> </tr> <tr> <td>enumeration</td> <td>2014</td> </tr> <tr> <td>enumeration</td> <td>2015</td> </tr> <tr> <td>enumeration</td> <td>2016</td> </tr> </tbody> </table>	Kind	Value	pattern	[1-9]{1}[0-9]*	enumeration	2007	enumeration	2008	enumeration	2009	enumeration	2010	enumeration	2011	enumeration	2012	enumeration	2013	enumeration	2014	enumeration	2015	enumeration	2016
Kind	Value																								
pattern	[1-9]{1}[0-9]*																								
enumeration	2007																								
enumeration	2008																								
enumeration	2009																								
enumeration	2010																								
enumeration	2011																								
enumeration	2012																								
enumeration	2013																								
enumeration	2014																								
enumeration	2015																								
enumeration	2016																								

element **Crediti_Imposta_Fondi_Pensione_Type/Reintegro**

diagram									
namespace	urn:www.agenziaentrate.gov.it:specificheTecniche:sco:730								
type	m730:Reintegro Totale Parziale Type								
facets	<table border="1"> <thead> <tr> <th>Kind</th> <th>Value</th> </tr> </thead> <tbody> <tr> <td>pattern</td> <td>[1-9]</td> </tr> <tr> <td>enumeration</td> <td>1</td> </tr> <tr> <td>enumeration</td> <td>2</td> </tr> </tbody> </table>	Kind	Value	pattern	[1-9]	enumeration	1	enumeration	2
Kind	Value								
pattern	[1-9]								
enumeration	1								
enumeration	2								

element **Crediti_Imposta_Fondi_Pensione_Type/SommaReintegrata**

diagram	
namespace	urn:www.agenziaentrate.gov.it:specificheTecniche:sco:730
type	DatoNP Type

facets	Kind	Value
	pattern	[1-9]{1}[0-9]*

element **Crediti_Imposta_Fondi_Pensione_Type/CreditoAnno**

diagram		
namespace	urn:www.agenziaentrate.gov.it:specificheTecniche:sco:730	
type	DatoNP_Type	
facets	Kind	Value
	pattern	[1-9]{1}[0-9]*

complexType **Crediti_Imposta_Reddi_Esteri_Type**

diagram		
namespace	urn:www.agenziaentrate.gov.it:specificheTecniche:sco:730	
children	m730:StatoEstero m730:Anno m730:RedditoEstero m730:ImpostaEstera m730:RedditoComplessivo m730:Imposta_Lorda m730:ImpostaNetta m730:CreditoDichiarazioniPrecedenti m730:DiCuiStatoEstero	

element **Crediti_Imposta_Reddi_Esteri_Type/StatoEstero**

diagram		
namespace	urn:www.agenziaentrate.gov.it:specificheTecniche:sco:730	
type	DatoAN_Type	
facets	Kind	Value
	pattern	([0-9A-Z-] \"){1}([0-9A-Z&:] ' - \., / ^°\^\(\ \) À È É Ì Ò Ù Û " \ \\ / +)*

element **Crediti_Imposta_Reddito_Esteri_Type/Anno**

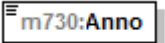
diagram	
namespace	urn:www.agenziaentrate.gov.it:specificheTecniche:sco:730
type	restriction of DatoDA_Type
facets	Kind Value pattern (18 19 20)[0-9]{2}

element **Crediti_Imposta_Reddito_Esteri_Type/RedditoEstero**

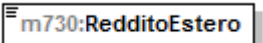
diagram	
namespace	urn:www.agenziaentrate.gov.it:specificheTecniche:sco:730
type	DatoNP_Type
facets	Kind Value pattern [1-9]{1}[0-9]*

element **Crediti_Imposta_Reddito_Esteri_Type/ImpostaEstera**

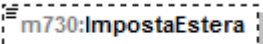
diagram	
namespace	urn:www.agenziaentrate.gov.it:specificheTecniche:sco:730
type	DatoNP_Type
facets	Kind Value pattern [1-9]{1}[0-9]*

element **Crediti_Imposta_Reddito_Esteri_Type/RedditoComplessivo**

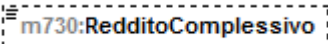
diagram	
namespace	urn:www.agenziaentrate.gov.it:specificheTecniche:sco:730
type	DatoNP_Type
facets	Kind Value pattern [1-9]{1}[0-9]*

element **Crediti_Imposta_Reddito_Esteri_Type/Imposta_Lorda**

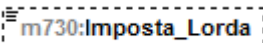
diagram	
namespace	urn:www.agenziaentrate.gov.it:specificheTecniche:sco:730
type	DatoNP_Type
facets	Kind Value pattern [1-9]{1}[0-9]*

element **Crediti_Imposta_Redditi_Esteri_Type/ImpostaNetta**

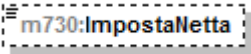
diagram	
namespace	urn:www.agenziaentrate.gov.it:specificheTecniche:sco:730
type	DatoNP_Type
facets	Kind Value pattern [1-9]{1}[0-9]*

element **Crediti_Imposta_Redditi_Esteri_Type/CreditoDichiarazioniPrecedenti**

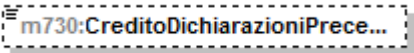
diagram	
namespace	urn:www.agenziaentrate.gov.it:specificheTecniche:sco:730
type	DatoNP_Type
facets	Kind Value pattern [1-9]{1}[0-9]*

element **Crediti_Imposta_Redditi_Esteri_Type/DiCuiStatoEstero**

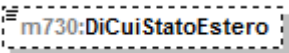
diagram	
namespace	urn:www.agenziaentrate.gov.it:specificheTecniche:sco:730
type	DatoNP_Type
facets	Kind Value pattern [1-9]{1}[0-9]*

complexType **Crediti_Imposta_Type**

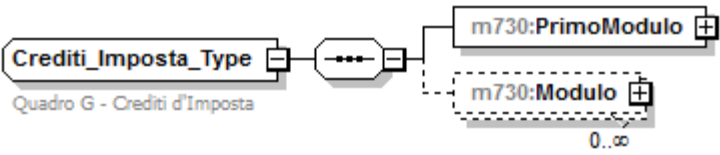
diagram	
namespace	urn:www.agenziaentrate.gov.it:specificheTecniche:sco:730
children	m730:PrimoModulo m730:Modulo

element **Crediti_Imposta_Type/PrimoModulo**

<p>diagram</p>	
<p>namespace</p>	<p>urn:www.agenziaentrate.gov.it:specificheTecniche:sco:730</p>
<p>type</p>	<p>m730:Primo_Modulo_Crediti_Imposta_Type</p>
<p>children</p>	<p>m730:CreditoImpostaFabbricati m730:CreditoImpostaFondiPensione m730:CreditoImpostaRedditiEsteri m730:CreditoPrimaCasaSismaAbruzzo m730:CreditoAltriSismaAbruzzo m730:CreditoIncrementoOccupazione m730:CreditoImpostaMediazioni m730:CreditoErogazioniCultura m730:CreditoNegoziazione m730:CreditoErogazioniScuola m730:CreditoVideosorveglianza</p>

element **Crediti_Imposta_Type/Modulo**

<p>diagram</p>	
<p>namespace</p>	<p>urn:www.agenziaentrate.gov.it:specificheTecniche:sco:730</p>

type	m730:Modulo_Crediti_Imposta_Type
children	m730:CreditoImpostaFondiPensione m730:CreditoImpostaRedditiEsteri m730:CreditoPrimaCasaSismaAbruzzo m730:CreditoAltriSismaAbruzzo m730:CreditoNegoziazione

complexType **Credito_Erogazioni_Cultura_Type**

diagram	
namespace	urn:www.agenziaentrate.gov.it:specificheTecniche:sco:730
children	m730:SpesaAnno m730:ResiduoAnnoPrec m730:RataAnnoPrec m730:RataDueAnniPrec

element **Credito_Erogazioni_Cultura_Type/SpesaAnno**

diagram					
namespace	urn:www.agenziaentrate.gov.it:specificheTecniche:sco:730				
type	DatoNP_Type				
facets	<table border="1"> <tr> <td>Kind</td> <td>Value</td> </tr> <tr> <td>pattern</td> <td>[1-9]{1}[0-9]*</td> </tr> </table>	Kind	Value	pattern	[1-9]{1}[0-9]*
Kind	Value				
pattern	[1-9]{1}[0-9]*				

element **Credito_Erogazioni_Cultura_Type/ResiduoAnnoPrec**

diagram					
namespace	urn:www.agenziaentrate.gov.it:specificheTecniche:sco:730				
type	DatoNP_Type				
facets	<table border="1"> <tr> <td>Kind</td> <td>Value</td> </tr> <tr> <td>pattern</td> <td>[1-9]{1}[0-9]*</td> </tr> </table>	Kind	Value	pattern	[1-9]{1}[0-9]*
Kind	Value				
pattern	[1-9]{1}[0-9]*				

element **Credito_Erogazioni_Cultura_Type/RataAnnoPrec**

diagram					
namespace	urn:www.agenziaentrate.gov.it:specificheTecniche:sco:730				
type	DatoNP_Type				
facets	<table border="1"> <tr> <td>Kind</td> <td>Value</td> </tr> <tr> <td>pattern</td> <td>[1-9]{1}[0-9]*</td> </tr> </table>	Kind	Value	pattern	[1-9]{1}[0-9]*
Kind	Value				
pattern	[1-9]{1}[0-9]*				

element **Credito_Erogazioni_Cultura_Type/RataDueAnniPrec**

diagram	
namespace	urn:www.agenziaentrate.gov.it:specificheTecniche:sco:730
type	DatoNP_Type
facets	Kind Value pattern [1-9]{1}[0-9]*

complexType **Credito_Erogazioni_Scuola_Type**

diagram	
namespace	urn:www.agenziaentrate.gov.it:specificheTecniche:sco:730
children	m730:SpesaAnno

element **Credito_Erogazioni_Scuola_Type/SpesaAnno**

diagram	
namespace	urn:www.agenziaentrate.gov.it:specificheTecniche:sco:730
type	DatoNP_Type
facets	Kind Value pattern [1-9]{1}[0-9]*

complexType **Credito_Immibile_Sisma_Abruzzo_Type**

diagram	
namespace	urn:www.agenziaentrate.gov.it:specificheTecniche:sco:730
children	m730:CodiceFiscale m730:NumeroRata m730:TotaleCredito

element **Credito_Immibile_Sisma_Abruzzo_Type/CodiceFiscale**

diagram	
namespace	urn:www.agenziaentrate.gov.it:specificheTecniche:sco:730
type	DatoCF_Type
facets	Kind Value

pattern	[0-9]{11}[A-Z]{6}[0-9LMNPQRSTU]{2}[A-Z]{1}[0-9LMNPQRSTU]{2}[A-Z]{1}[0-9LMNPQRSTU]{3}[A-Z]{1}
---------	--

element Credito_Immobile_Sisma_Abruzzo_Type/NumeroRata

diagram																					
namespace	urn:www.agenziaentrate.gov.it:specificheTecniche:sco:730																				
type	restriction of DatoNP_Type																				
facets	<table border="1"> <thead> <tr> <th>Kind</th> <th>Value</th> </tr> </thead> <tbody> <tr> <td>pattern</td> <td>[1-9]{1}[0-9]*</td> </tr> <tr> <td>enumeration</td> <td>1</td> </tr> <tr> <td>enumeration</td> <td>2</td> </tr> <tr> <td>enumeration</td> <td>3</td> </tr> <tr> <td>enumeration</td> <td>4</td> </tr> <tr> <td>enumeration</td> <td>5</td> </tr> <tr> <td>enumeration</td> <td>6</td> </tr> <tr> <td>enumeration</td> <td>7</td> </tr> <tr> <td>enumeration</td> <td>8</td> </tr> </tbody> </table>	Kind	Value	pattern	[1-9]{1}[0-9]*	enumeration	1	enumeration	2	enumeration	3	enumeration	4	enumeration	5	enumeration	6	enumeration	7	enumeration	8
Kind	Value																				
pattern	[1-9]{1}[0-9]*																				
enumeration	1																				
enumeration	2																				
enumeration	3																				
enumeration	4																				
enumeration	5																				
enumeration	6																				
enumeration	7																				
enumeration	8																				

element Credito_Immobile_Sisma_Abruzzo_Type/TotaleCredito

diagram					
namespace	urn:www.agenziaentrate.gov.it:specificheTecniche:sco:730				
type	DatoNP_Type				
facets	<table border="1"> <thead> <tr> <th>Kind</th> <th>Value</th> </tr> </thead> <tbody> <tr> <td>pattern</td> <td>[1-9]{1}[0-9]*</td> </tr> </tbody> </table>	Kind	Value	pattern	[1-9]{1}[0-9]*
Kind	Value				
pattern	[1-9]{1}[0-9]*				

complexType Credito_Incremento_Occupazione_Type

diagram	
namespace	urn:www.agenziaentrate.gov.it:specificheTecniche:sco:730
children	m730:ResiduoPrecedenteDichiarazione m730:DiCuiCompensatoF24

element Credito_Incremento_Occupazione_Type/ResiduoPrecedenteDichiarazione

diagram					
namespace	urn:www.agenziaentrate.gov.it:specificheTecniche:sco:730				
type	DatoNP_Type				
facets	<table border="1"> <thead> <tr> <th>Kind</th> <th>Value</th> </tr> </thead> <tbody> <tr> <td>pattern</td> <td>[1-9]{1}[0-9]*</td> </tr> </tbody> </table>	Kind	Value	pattern	[1-9]{1}[0-9]*
Kind	Value				
pattern	[1-9]{1}[0-9]*				

element **Credito_Incremento_Occupazione_Type/DiCuiCompensatoF24**

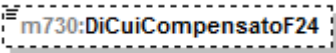
diagram	
namespace	urn:www.agenziaentrate.gov.it:specificheTecniche:sco:730
type	DatoNP_Type
facets	Kind Value pattern [1-9]{1}[0-9]*

complexType **Credito_Negoziatore_Type**

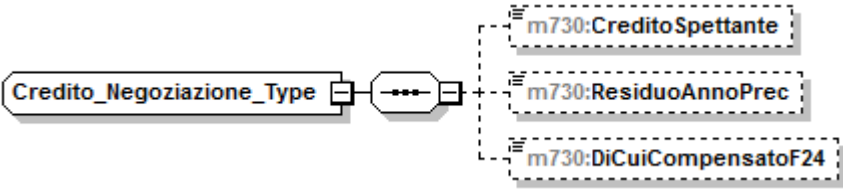
diagram	
namespace	urn:www.agenziaentrate.gov.it:specificheTecniche:sco:730
children	m730:CreditoSpettante m730:ResiduoAnnoPrec m730:DiCuiCompensatoF24

element **Credito_Negoziatore_Type/CreditoSpettante**

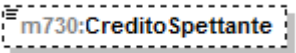
diagram	
namespace	urn:www.agenziaentrate.gov.it:specificheTecniche:sco:730
type	DatoNP_Type
facets	Kind Value pattern [1-9]{1}[0-9]*

element **Credito_Negoziatore_Type/ResiduoAnnoPrec**

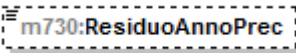
diagram	
namespace	urn:www.agenziaentrate.gov.it:specificheTecniche:sco:730
type	DatoNP_Type
facets	Kind Value pattern [1-9]{1}[0-9]*

element **Credito_Negoziatore_Type/DiCuiCompensatoF24**

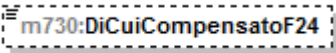
diagram	
namespace	urn:www.agenziaentrate.gov.it:specificheTecniche:sco:730
type	DatoNP_Type

facets	Kind pattern	Value [1-9]{1}[0-9]*
--------	-----------------	-------------------------

complexType Credito_Stato_Type

diagram	
namespace	urn:www.agenziaentrate.gov.it:specificheTecniche:sco:730
children	m730:Stato m730:Credito

element Credito_Stato_Type/Stato

diagram		
namespace	urn:www.agenziaentrate.gov.it:specificheTecniche:sco:730	
type	DatoAN_Type	
facets	Kind pattern	Value ([0-9A-Z-] \"){1}([0-9A-Z&:] ' - \., / "^\(\)\) À É È Ì Ò Ù Ü " \ \\ \ +)*

element Credito_Stato_Type/Credito

diagram		
namespace	urn:www.agenziaentrate.gov.it:specificheTecniche:sco:730	
type	DatoNP_Type	
facets	Kind pattern	Value [1-9]{1}[0-9]*

complexType Credito_Type

diagram	
namespace	urn:www.agenziaentrate.gov.it:specificheTecniche:sco:730
children	m730:NonRimborsabile m730:Credito m730:CreditoF24 m730:CreditoRimborso

element Credito_Type/NonRimborsabile

diagram	
namespace	urn:www.agenziaentrate.gov.it:specificheTecniche:sco:730
type	DatoNP_Type
facets	Kind Value pattern [1-9]{1}[0-9]*

element Credito_Type/Credito

diagram	
namespace	urn:www.agenziaentrate.gov.it:specificheTecniche:sco:730
type	DatoNP_Type
facets	Kind Value pattern [1-9]{1}[0-9]*

element Credito_Type/CreditoF24

diagram	
namespace	urn:www.agenziaentrate.gov.it:specificheTecniche:sco:730
type	DatoNP_Type
facets	Kind Value pattern [1-9]{1}[0-9]*

element Credito_Type/CreditoRimborso

diagram	
namespace	urn:www.agenziaentrate.gov.it:specificheTecniche:sco:730
type	DatoNP_Type
facets	Kind Value pattern [1-9]{1}[0-9]*

complexType Credito_Videosorveglianza_Type

diagram	
namespace	urn:www.agenziaentrate.gov.it:specificheTecniche:sco:730
children	m730:CreditoSpettante m730:DiCuiCompensatoF24

element **Credito_Videosorveglianza_Type/CreditoSpettante**

diagram	
namespace	urn:www.agenziaentrate.gov.it:specificheTecniche:sco:730
type	DatoNP_Type
facets	Kind Value pattern [1-9]{1}[0-9]*

element **Credito_Videosorveglianza_Type/DiCuiCompensatoF24**

diagram	
namespace	urn:www.agenziaentrate.gov.it:specificheTecniche:sco:730
type	DatoNP_Type
facets	Kind Value pattern [1-9]{1}[0-9]*

complexType **Dati_730_Integrativo_Type**

diagram	
namespace	urn:www.agenziaentrate.gov.it:specificheTecniche:sco:730
children	m730:Rimborso m730:Credito

element **Dati_730_Integrativo_Type/Rimborso**

diagram	
namespace	urn:www.agenziaentrate.gov.it:specificheTecniche:sco:730
type	m730:Elemento_Integrativo_Type
children	m730:lrpef m730:AddizionaleRegionalelrpef m730:AddComunalelrpef m730:CedolareSecca

element **Dati_730_Integrativo_Type/Credito**

diagram	<p>The diagram shows a dashed box labeled 'm730:Credito' connected to a central octagonal connector. This connector is linked to a larger dashed box labeled 'm730:Elemento_Integrativo_Type'. Inside this box, four elements are listed: 'm730:Irpef', 'm730:AddizionaleRegionaleIrpef', 'm730:AddComunaleIrpef', and 'm730:Cedolare Secca', each connected to the central connector.</p>
namespace	urn:www.agenziaentrate.gov.it:specificheTecniche:sco:730
type	m730:Elemento_Integrativo_Type
children	m730:Irpef m730:AddizionaleRegionaleIrpef m730:AddComunaleIrpef m730:CedolareSecca

complexType **Dati_Altri_Detrazioni_Modulo_Type**

diagram	<p>The diagram shows a dashed box labeled 'Dati_Altri_Detrazioni_Modulo_Type' connected to a central octagonal connector, which is then connected to a dashed box labeled 'm730:AltreDetrazioni'.</p>
namespace	urn:www.agenziaentrate.gov.it:specificheTecniche:sco:730
children	m730:AltreDetrazioni

element **Dati_Altri_Detrazioni_Modulo_Type/AltreDetrazioni**

diagram	<p>The diagram shows a dashed box labeled 'm730:AltreDetrazioni' connected to a central octagonal connector. This connector is linked to a larger dashed box labeled 'm730:Altre_Detrazioni_Type'. Inside this box, two elements are listed: 'm730:Codice' and 'm730:Importo', each connected to the central connector.</p>
namespace	urn:www.agenziaentrate.gov.it:specificheTecniche:sco:730
type	m730:Altre_Detrazioni_Type
children	m730:Codice m730:Importo

complexType Dati_Altre_Detrazioni_Type

diagram	
namespace	urn:www.agenziaentrate.gov.it:specificheTecniche:sco:730
children	m730:SpeseCaniGuida m730:AffittoTerreniAgricoliGiovani m730:AltreDetrazioni

element Dati_Altre_Detrazioni_Type/SpeseCaniGuida

diagram					
namespace	urn:www.agenziaentrate.gov.it:specificheTecniche:sco:730				
type	DatoCB_Type				
facets	<table border="1"> <thead> <tr> <th>Kind</th> <th>Value</th> </tr> </thead> <tbody> <tr> <td>pattern</td> <td>[01]</td> </tr> </tbody> </table>	Kind	Value	pattern	[01]
Kind	Value				
pattern	[01]				

element Dati_Altre_Detrazioni_Type/AffittoTerreniAgricoliGiovani

diagram					
namespace	urn:www.agenziaentrate.gov.it:specificheTecniche:sco:730				
type	DatoNP_Type				
facets	<table border="1"> <thead> <tr> <th>Kind</th> <th>Value</th> </tr> </thead> <tbody> <tr> <td>pattern</td> <td>[1-9]{1}[0-9]*</td> </tr> </tbody> </table>	Kind	Value	pattern	[1-9]{1}[0-9]*
Kind	Value				
pattern	[1-9]{1}[0-9]*				

element Dati_Altre_Detrazioni_Type/AltreDetrazioni

diagram	
namespace	urn:www.agenziaentrate.gov.it:specificheTecniche:sco:730
type	m730:Altre_Detrazioni_Type
children	m730:Codice m730:Importo

complexType **Dati_Associazioni_Professionale_Type**

diagram	
namespace	urn:www.agenziaentrate.gov.it:specificheTecniche:sco:730
children	m730:CFAssociazione m730:DenominazioneAssociazione m730:CFProfessionista m730:CognomeProfessionista m730:NomeProfessionista

element **Dati_Associazioni_Professionale_Type/CFAssociazione**

diagram					
namespace	urn:www.agenziaentrate.gov.it:specificheTecniche:sco:730				
type	DatoCN_Type				
facets	<table border="1"> <thead> <tr> <th>Kind</th> <th>Value</th> </tr> </thead> <tbody> <tr> <td>pattern</td> <td>[0-9]{11}</td> </tr> </tbody> </table>	Kind	Value	pattern	[0-9]{11}
Kind	Value				
pattern	[0-9]{11}				

element **Dati_Associazioni_Professionale_Type/DenominazioneAssociazione**

diagram					
namespace	urn:www.agenziaentrate.gov.it:specificheTecniche:sco:730				
type	DatoAN_Type				
facets	<table border="1"> <thead> <tr> <th>Kind</th> <th>Value</th> </tr> </thead> <tbody> <tr> <td>pattern</td> <td>([0-9A-Z- &quot;]{1}([0-9A-Z&amp;] ' \"- \". / ° \"\\(\\) À É È Ì Ò Ù Ú &quot; \\\" \\+)*</td> </tr> </tbody> </table>	Kind	Value	pattern	([0-9A-Z- "]{1}([0-9A-Z&] ' \"- \". / ° \"\\(\\) À É È Ì Ò Ù Ú " \\\" \\+)*
Kind	Value				
pattern	([0-9A-Z- "]{1}([0-9A-Z&] ' \"- \". / ° \"\\(\\) À É È Ì Ò Ù Ú " \\\" \\+)*				

element **Dati_Associazioni_Professionale_Type/CFProfessionista**

diagram					
namespace	urn:www.agenziaentrate.gov.it:specificheTecniche:sco:730				
type	DatoCF_Type				
facets	<table border="1"> <thead> <tr> <th>Kind</th> <th>Value</th> </tr> </thead> <tbody> <tr> <td>pattern</td> <td>[0-9]{11}[A-Z]{6}[0-9LMNPQRSTUUV]{2}[A-Z]{1}[0-9LMNPQRSTUUV]{2}[A-Z]{1}[0-9LMNPQRSTUUV]{3}[A-Z]{1}</td> </tr> </tbody> </table>	Kind	Value	pattern	[0-9]{11}[A-Z]{6}[0-9LMNPQRSTUUV]{2}[A-Z]{1}[0-9LMNPQRSTUUV]{2}[A-Z]{1}[0-9LMNPQRSTUUV]{3}[A-Z]{1}
Kind	Value				
pattern	[0-9]{11}[A-Z]{6}[0-9LMNPQRSTUUV]{2}[A-Z]{1}[0-9LMNPQRSTUUV]{2}[A-Z]{1}[0-9LMNPQRSTUUV]{3}[A-Z]{1}				

element **Dati_Associazioni_Professionale_Type/CognomeProfessionista**

diagram	
namespace	urn:www.agenziaentrate.gov.it:specificheTecniche:sco:730
type	DatoAN_Type
facets	Kind Value pattern ([0-9A-Z-]*)"}{1}([0-9A-Z&#39; \"- \\. / ^\\(\\) À É È Ì Ò Ù Û " \\ \\ \\+)*

element **Dati_Associazioni_Professionale_Type/NomeProfessionista**

diagram	
namespace	urn:www.agenziaentrate.gov.it:specificheTecniche:sco:730
type	DatoAN_Type
facets	Kind Value pattern ([0-9A-Z-]*)"}{1}([0-9A-Z&#39; \"- \\. / ^\\(\\) À É È Ì Ò Ù Û " \\ \\ \\+)*

complexType **Dati_CAF_Type**

diagram	
namespace	urn:www.agenziaentrate.gov.it:specificheTecniche:sco:730
children	m730:CFCaf m730:DenominazioneCaf m730:NumeroAlbo

element **Dati_CAF_Type/CFCaf**

diagram	
namespace	urn:www.agenziaentrate.gov.it:specificheTecniche:sco:730
type	DatoCN_Type
facets	Kind Value pattern [0-9]{11}

element **Dati_CAF_Type/DenominazioneCaf**

diagram	
namespace	urn:www.agenziaentrate.gov.it:specificheTecniche:sco:730
type	DatoAN_Type

facets	Kind	Value
	pattern	([0-9A-Z\-\] \"){1}([0-9A-Z&#39;] \" \- \., / ° ^\(\\ \\) À É Ê Ë Ì Ò Ù Ú " \\ \\ \\ +)*

element Dati_CAF_Type/NumeroAlbo

diagram	
namespace	urn:www.agenziaentrate.gov.it:specificheTecniche:sco:730
type	restriction of DatoNP_Type
facets	Kind Value pattern [1-9]{1}[0-9]*

complexType Dati_Catastali_Recupero_Patrimonio_Edilizio_Type

diagram	
namespace	urn:www.agenziaentrate.gov.it:specificheTecniche:sco:730
children	m730:NOrdImmobile m730:Condominio m730:DatiCatastali

element Dati_Catastali_Recupero_Patrimonio_Edilizio_Type/NOrdImmobile

diagram	
namespace	urn:www.agenziaentrate.gov.it:specificheTecniche:sco:730
type	DatoNP_Type
facets	Kind Value pattern [1-9]{1}[0-9]*

element Dati_Catastali_Recupero_Patrimonio_Edilizio_Type/Condominio

diagram	
namespace	urn:www.agenziaentrate.gov.it:specificheTecniche:sco:730
type	DatoCB_Type
facets	Kind Value pattern [01]

element **Dati_Catastali_Recupero_Patrimonio_Edilizio_Type/DatiCatastali**

diagram	
namespace	urn:www.agenziaentrate.gov.it:specificheTecniche:sco:730
type	m730:Dati_Catastali_Type
children	m730:CodiceComune m730:TerreniUrbano m730:SezioneUrbanaComuneCatastale m730:Foglio m730:Particella m730:Subalterno

complexType **Dati_Catastali_Type**

diagram	
namespace	urn:www.agenziaentrate.gov.it:specificheTecniche:sco:730
children	m730:CodiceComune m730:TerreniUrbano m730:SezioneUrbanaComuneCatastale m730:Foglio m730:Particella m730:Subalterno

element **Dati_Catastali_Type/CodiceComune**

diagram					
namespace	urn:www.agenziaentrate.gov.it:specificheTecniche:sco:730				
type	DatoAN_Type				
facets	<table border="0"> <tr> <td>Kind</td> <td>Value</td> </tr> <tr> <td>pattern</td> <td>(([0-9A-Z-] \&quot;){1}([0-9A-Z&amp;] '\ - \., / ^*\(\ \)\) À É È Ì Ò Ù Û &quot; \ \ \+)*</td> </tr> </table>	Kind	Value	pattern	(([0-9A-Z-] \"){1}([0-9A-Z&] '\ - \., / ^*\(\ \)\) À É È Ì Ò Ù Û " \ \ \+)*
Kind	Value				
pattern	(([0-9A-Z-] \"){1}([0-9A-Z&] '\ - \., / ^*\(\ \)\) À É È Ì Ò Ù Û " \ \ \+)*				

element **Dati_Catastali_Type/TerreniUrbano**

diagram									
namespace	urn:www.agenziaentrate.gov.it:specificheTecniche:sco:730								
type	m730:Terreni Urbano Type								
facets	<table border="0"> <tr> <td>Kind</td> <td>Value</td> </tr> <tr> <td>pattern</td> <td>(([0-9A-Z\-\]]&quot;){1}([0-9A-Z&amp;:] ' \" \" / ° \"^\"\\(\\) À È É Ì Ò Ù Û &quot; \\\" \\+)*</td> </tr> <tr> <td>enumeration</td> <td>T</td> </tr> <tr> <td>enumeration</td> <td>U</td> </tr> </table>	Kind	Value	pattern	(([0-9A-Z\-\]]"){1}([0-9A-Z&:] ' \" \" / ° \"^\"\\(\\) À È É Ì Ò Ù Û " \\\" \\+)*	enumeration	T	enumeration	U
Kind	Value								
pattern	(([0-9A-Z\-\]]"){1}([0-9A-Z&:] ' \" \" / ° \"^\"\\(\\) À È É Ì Ò Ù Û " \\\" \\+)*								
enumeration	T								
enumeration	U								

element **Dati_Catastali_Type/SezioneUrbanaComuneCatastale**

diagram					
namespace	urn:www.agenziaentrate.gov.it:specificheTecniche:sco:730				
type	DatoAN Type				
facets	<table border="0"> <tr> <td>Kind</td> <td>Value</td> </tr> <tr> <td>pattern</td> <td>(([0-9A-Z\-\]]&quot;){1}([0-9A-Z&amp;:] ' \" \" / ° \"^\"\\(\\) À È É Ì Ò Ù Û &quot; \\\" \\+)*</td> </tr> </table>	Kind	Value	pattern	(([0-9A-Z\-\]]"){1}([0-9A-Z&:] ' \" \" / ° \"^\"\\(\\) À È É Ì Ò Ù Û " \\\" \\+)*
Kind	Value				
pattern	(([0-9A-Z\-\]]"){1}([0-9A-Z&:] ' \" \" / ° \"^\"\\(\\) À È É Ì Ò Ù Û " \\\" \\+)*				

element **Dati_Catastali_Type/Foglio**

diagram					
namespace	urn:www.agenziaentrate.gov.it:specificheTecniche:sco:730				
type	DatoAN Type				
facets	<table border="0"> <tr> <td>Kind</td> <td>Value</td> </tr> <tr> <td>pattern</td> <td>(([0-9A-Z\-\]]&quot;){1}([0-9A-Z&amp;:] ' \" \" / ° \"^\"\\(\\) À È É Ì Ò Ù Û &quot; \\\" \\+)*</td> </tr> </table>	Kind	Value	pattern	(([0-9A-Z\-\]]"){1}([0-9A-Z&:] ' \" \" / ° \"^\"\\(\\) À È É Ì Ò Ù Û " \\\" \\+)*
Kind	Value				
pattern	(([0-9A-Z\-\]]"){1}([0-9A-Z&:] ' \" \" / ° \"^\"\\(\\) À È É Ì Ò Ù Û " \\\" \\+)*				

element **Dati_Catastali_Type/Particella**

diagram	
namespace	urn:www.agenziaentrate.gov.it:specificheTecniche:sco:730
children	m730:Numeratore m730:Denominatore

element **Dati_Catastali_Type/Particella/Numeratore**

diagram	
namespace	urn:www.agenziaentrate.gov.it:specificheTecniche:sco:730

type	DatoAN_Type
facets	Kind Value pattern ([0-9A-Z\-_]"){1}([0-9A-Z&:] \- \., / ^°\^\(\)\) À É È Ì Ò Ù Û " \ \ \+)*

element Dati_Catastali_Type/Particella/Denominatore

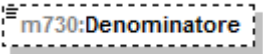
diagram	
namespace	urn:www.agenziaentrate.gov.it:specificheTecniche:sco:730
type	DatoAN_Type
facets	Kind Value pattern ([0-9A-Z\-_]"){1}([0-9A-Z&:] \- \., / ^°\^\(\)\) À É È Ì Ò Ù Û " \ \ \+)*

element Dati_Catastali_Type/Subalterno

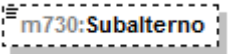
diagram	
namespace	urn:www.agenziaentrate.gov.it:specificheTecniche:sco:730
type	DatoAN_Type
facets	Kind Value pattern ([0-9A-Z\-_]"){1}([0-9A-Z&:] \- \., / ^°\^\(\)\) À É È Ì Ò Ù Û " \ \ \+)*

complexType Dati_Condominio_Type

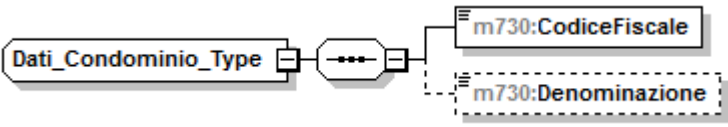
diagram	
namespace	urn:www.agenziaentrate.gov.it:specificheTecniche:sco:730
children	m730:CodiceFiscale m730:Denominazione

element Dati_Condominio_Type/CodiceFiscale

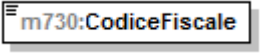
diagram	
namespace	urn:www.agenziaentrate.gov.it:specificheTecniche:sco:730
type	DatoCF_Type
facets	Kind Value pattern [0-9]{11}[A-Z]{6}[0-9LMNPQRSTU]{2}[A-Z]{1}[0-9LMNPQRSTU]{2}[A-Z]{1}[0-9LMNPQRSTU]{3}[A-Z]{1}

element Dati_Condominio_Type/Denominazione

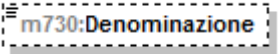
diagram	
---------	---

namespace	urn:www.agenziaentrate.gov.it:specificheTecniche:sco:730
type	DatoAN_Type
facets	Kind Value pattern ([0-9A-Z\-_]{"1}([0-9A-Z&#92; ' \- \., / "^\(\ \)\ À É È Ì Ò Ù Û " \ \\ \ +)*

complexType Dati_Coniuge_Type

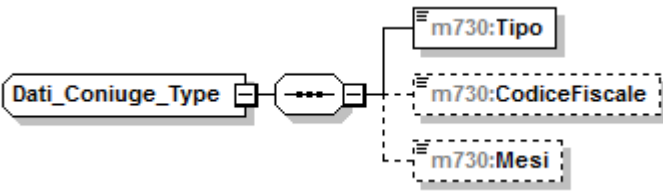
diagram	
namespace	urn:www.agenziaentrate.gov.it:specificheTecniche:sco:730
children	m730:Tipo m730:CodiceFiscale m730:Mesi

element Dati_Coniuge_Type/Tipo

diagram	
namespace	urn:www.agenziaentrate.gov.it:specificheTecniche:sco:730
type	DatoCB_Type
facets	Kind Value pattern [01]

element Dati_Coniuge_Type/CodiceFiscale

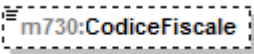
diagram	
namespace	urn:www.agenziaentrate.gov.it:specificheTecniche:sco:730
type	DatoCF_Type
facets	Kind Value pattern [0-9]{11}[A-Z]{6}[0-9LMNPQRSTUVWXYZ]{2}[A-Z]{1}[0-9LMNPQRSTUVWXYZ]{2}[A-Z]{1}[0-9LMNPQRSTUVWXYZ]{3}[A-Z]{1}

element Dati_Coniuge_Type/Mesi

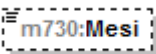
diagram	
namespace	urn:www.agenziaentrate.gov.it:specificheTecniche:sco:730
type	m730:Mesi_Type
facets	Kind Value pattern [1-9]{1}[0-9]* enumeration 1 enumeration 2 enumeration 3 enumeration 4

	enumeration	5
	enumeration	6
	enumeration	7
	enumeration	8
	enumeration	9
	enumeration	10
	enumeration	11
	enumeration	12

complexType **Dati_Contabili_Type**

<p>diagram</p>	
<p>namespace</p>	<p>urn:www.agenziaentrate.gov.it:specificheTecniche:sco:730</p>
<p>children</p>	<p>m730:Familiari m730:QuadroA m730:QuadroB m730:QuadroC m730:QuadroD m730:QuadroE m730:QuadroF m730:QuadroG m730:QuadroI m730:ProspettoLiquidazione m730:Prospetto_Annotazioni m730:QuadroK</p>

element **Dati_Contabili_Type/Familiari**

<p>diagram</p>	
<p>namespace</p>	<p>urn:www.agenziaentrate.gov.it:specificheTecniche:sco:730</p>

type	m730:Familiari_Type
children	m730:PrimoModulo m730:Modulo

element Dati_Contabili_Type/QuadroA

diagram	
namespace	urn:www.agenziaentrate.gov.it:specificheTecniche:sco:730
type	m730:Redditi_Terreni_Type
children	m730:Modulo

element Dati_Contabili_Type/QuadroB

diagram	
namespace	urn:www.agenziaentrate.gov.it:specificheTecniche:sco:730
type	m730:Redditi_Fabbricati_Type
children	m730:Modulo

element Dati_Contabili_Type/QuadroC

diagram	
namespace	urn:www.agenziaentrate.gov.it:specificheTecniche:sco:730
type	m730:Redditi_Lavoro_Dip_Type
children	m730:PrimoModulo m730:Modulo

element **Dati_Contabili_Type/QuadroD**

diagram	
namespace	urn:www.agenziaentrate.gov.it:specificheTecniche:sco:730
type	extension of m730:Altri_Reddit_Type
children	m730:Modulo

element **Dati_Contabili_Type/QuadroE**

diagram	
namespace	urn:www.agenziaentrate.gov.it:specificheTecniche:sco:730
type	m730:Oneri_Type
children	m730:PrimoModulo m730:Modulo

element **Dati_Contabili_Type/QuadroF**

diagram	
namespace	urn:www.agenziaentrate.gov.it:specificheTecniche:sco:730
type	m730:Acconti_Ritenute_Type
children	m730:PrimoModulo m730:Modulo

element **Dati_Contabili_Type/QuadroG**

diagram	
namespace	urn:www.agenziaentrate.gov.it:specificheTecniche:sco:730
type	m730:Crediti_Imposta_Type
children	m730:PrimoModulo m730:Modulo

element **Dati_Contabili_Type/Quadrol**

diagram	
namespace	urn:www.agenziaentrate.gov.it:specificheTecniche:sco:730
type	m730:Quadro_I_Type
children	m730:Importo m730:Casella

element **Dati_Contabili_Type/ProspettoLiquidazione**

diagram	
namespace	urn:www.agenziaentrate.gov.it:specificheTecniche:sco:730
type	m730:Prospetto_Liquidazione_Type
children	m730:PrimoModulo m730:Modulo

element **Dati_Contabili_Type/Prospetto_Annotazioni**

diagram	
namespace	urn:www.agenziaentrate.gov.it:specificheTecniche:sco:730
type	m730:Prospetto_Annotazioni_Type
children	m730:Modulo_Annotazioni

element **Dati_Contabili_Type/QuadroK**

diagram	
namespace	urn:www.agenziaentrate.gov.it:specificheTecniche:sco:730
type	m730:Comunicazione_Amministratore_Type
children	m730:Modulo

complexType **Dati_Contratto_Type**

diagram	
namespace	urn:www.agenziaentrate.gov.it:specificheTecniche:sco:730
children	m730:DataRegContratto m730:SerieContratto m730:NumeroContratto m730:Sottonumero m730:CodiceUfficio m730:IdentificativoContratto

element **Dati_Contratto_Type/DataRegContratto**

diagram	
---------	--

namespace	urn:www.agenziaentrate.gov.it:specificheTecniche:sco:730
type	DatoDT_Type
facets	Kind Value pattern ((([0-9]{12}[0-9]{3}[01])(0[13578][10]12)\d{4}))(((0[1-9][12][0-9]{30})(0[469][11]\d{4}))((0[1-9][10-9]{2}[0-8])(02)\d{4}))((29)(02)([02468][048]00))((29)(02)([13579][26]00))((29)(02)([0-9][0-9][0148]))((29)(02)([0-9][0-9][2468][048]))((29)(02)([0-9][0-9][13579][26]))

element Dati_Contratto_Type/SerieContratto

diagram	
namespace	urn:www.agenziaentrate.gov.it:specificheTecniche:sco:730
type	m730:Serie_Registrazione_Contratto_Type
facets	Kind Value pattern ([0-9A-Z-] \"){1}([0-9A-Z&:] \- \., / \° \^ \(\) \À \É \È \ Ò \Ù \Û \" \ \\ \ +)* enumeration 3 enumeration 3A enumeration 3B enumeration 3P enumeration 3T

element Dati_Contratto_Type/NumeroContratto

diagram	
namespace	urn:www.agenziaentrate.gov.it:specificheTecniche:sco:730
type	DatoAN_Type
facets	Kind Value pattern ([0-9A-Z-] \"){1}([0-9A-Z&:] \- \., / \° \^ \(\) \À \É \È \ Ò \Ù \Û \" \ \\ \ +)*

element Dati_Contratto_Type/Sottonumero

diagram	
namespace	urn:www.agenziaentrate.gov.it:specificheTecniche:sco:730
type	DatoAN_Type
facets	Kind Value pattern ([0-9A-Z-] \"){1}([0-9A-Z&:] \- \., / \° \^ \(\) \À \É \È \ Ò \Ù \Û \" \ \\ \ +)*

element Dati_Contratto_Type/CodiceUfficio

diagram	
namespace	urn:www.agenziaentrate.gov.it:specificheTecniche:sco:730
type	restriction of DatoAN_Type
facets	Kind Value pattern ([0-9A-Z-] \"){1}([0-9A-Z&:] \- \., / \° \^ \(\) \À \É \È \ Ò \Ù \Û \" \ \\ \ +)*

element Dati_Contratto_Type/IdentificativoContratto

diagram	
namespace	urn:www.agenziaentrate.gov.it:specificheTecniche:sco:730
type	DatoAN_Type
facets	Kind Value pattern ([0-9A-Z- "){1}([0-9A-Z&:] ' - \., / ^ \^\(\\) À È É Ì Ò Ù Ú " \\ \\ +)*

complexType Dati_Familiare_Type

diagram	
namespace	urn:www.agenziaentrate.gov.it:specificheTecniche:sco:730
children	m730:CodiceFiscale m730:Mesi m730:MesiMinore m730:PercDetraz m730:PercDetrazCon m730:Affidamento

element Dati_Familiare_Type/CodiceFiscale

diagram	
namespace	urn:www.agenziaentrate.gov.it:specificheTecniche:sco:730
type	DatoCF_Type
facets	Kind Value pattern [0-9]{11}[A-Z]{6}[0-9LMNPQRSTU]{2}[A-Z]{1}[0-9LMNPQRSTU]{2}[A-Z]{1}[0-9LMNPQRSTU]{3}[A-Z]{1}

element Dati_Familiare_Type/Mesi

diagram	
namespace	urn:www.agenziaentrate.gov.it:specificheTecniche:sco:730
type	DatoNP_Type
facets	Kind Value pattern [1-9]{1}[0-9]*

element Dati_Familiare_Type/MesiMinore

diagram					
namespace	urn:www.agenziaentrate.gov.it:specificheTecniche:sco:730				
type	DatoNP_Type				
facets	<table border="1"> <tr> <td>Kind</td> <td>Value</td> </tr> <tr> <td>pattern</td> <td>[1-9]{1}[0-9]*</td> </tr> </table>	Kind	Value	pattern	[1-9]{1}[0-9]*
Kind	Value				
pattern	[1-9]{1}[0-9]*				

element Dati_Familiare_Type/PercDetraz

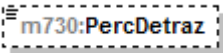
diagram					
namespace	urn:www.agenziaentrate.gov.it:specificheTecniche:sco:730				
type	DatoPC_Type				
facets	<table border="1"> <tr> <td>Kind</td> <td>Value</td> </tr> <tr> <td>pattern</td> <td>[0-9]?[0-9](, d{1,3})? 100(,0{1,3})?</td> </tr> </table>	Kind	Value	pattern	[0-9]?[0-9](, d{1,3})? 100(,0{1,3})?
Kind	Value				
pattern	[0-9]?[0-9](, d{1,3})? 100(,0{1,3})?				

element Dati_Familiare_Type/PercDetrazCon

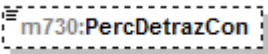
diagram					
namespace	urn:www.agenziaentrate.gov.it:specificheTecniche:sco:730				
type	DatoAN_Type				
facets	<table border="1"> <tr> <td>Kind</td> <td>Value</td> </tr> <tr> <td>pattern</td> <td>(([0-9A-Z\-\]]&quot;){1}([0-9A-Z&amp;#92; ^\-\. , ! ° ^\(\\ \\) À É È Ì Ò Ù Û &quot; \\ \\ \\ +)*</td> </tr> </table>	Kind	Value	pattern	(([0-9A-Z\-\]]"){1}([0-9A-Z&#92; ^\-\. , ! ° ^\(\\ \\) À É È Ì Ò Ù Û " \\ \\ \\ +)*
Kind	Value				
pattern	(([0-9A-Z\-\]]"){1}([0-9A-Z&#92; ^\-\. , ! ° ^\(\\ \\) À É È Ì Ò Ù Û " \\ \\ \\ +)*				

element Dati_Familiare_Type/Affidamento

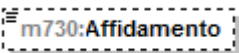
diagram					
namespace	urn:www.agenziaentrate.gov.it:specificheTecniche:sco:730				
type	DatoCB_Type				
facets	<table border="1"> <tr> <td>Kind</td> <td>Value</td> </tr> <tr> <td>pattern</td> <td>[01]</td> </tr> </table>	Kind	Value	pattern	[01]
Kind	Value				
pattern	[01]				

complexType **Dati_Fornitore_Type**

diagram	
namespace	urn:www.agenziaentrate.gov.it:specificheTecniche:sco:730
children	m730:CodiceFiscale m730:CognomeDenom m730:Nome m730:Sesso m730:DataNascita m730:ComuneNascita m730:ProvinciaNascita m730:ImportoAcquisti

element **Dati_Fornitore_Type/CodiceFiscale**

diagram					
namespace	urn:www.agenziaentrate.gov.it:specificheTecniche:sco:730				
type	DatoCF_Type				
facets	<table border="1"> <thead> <tr> <th>Kind</th> <th>Value</th> </tr> </thead> <tbody> <tr> <td>pattern</td> <td>[0-9]{11}[A-Z]{6}[0-9LMNPQRSTUUV]{2}[A-Z]{1}[0-9LMNPQRSTUUV]{2}[A-Z]{1}[0-9LMNPQRSTUUV]{3}[A-Z]{1}</td> </tr> </tbody> </table>	Kind	Value	pattern	[0-9]{11}[A-Z]{6}[0-9LMNPQRSTUUV]{2}[A-Z]{1}[0-9LMNPQRSTUUV]{2}[A-Z]{1}[0-9LMNPQRSTUUV]{3}[A-Z]{1}
Kind	Value				
pattern	[0-9]{11}[A-Z]{6}[0-9LMNPQRSTUUV]{2}[A-Z]{1}[0-9LMNPQRSTUUV]{2}[A-Z]{1}[0-9LMNPQRSTUUV]{3}[A-Z]{1}				

element **Dati_Fornitore_Type/CognomeDenom**

diagram					
namespace	urn:www.agenziaentrate.gov.it:specificheTecniche:sco:730				
type	DatoAN_Type				
facets	<table border="1"> <thead> <tr> <th>Kind</th> <th>Value</th> </tr> </thead> <tbody> <tr> <td>pattern</td> <td>([0-9A-Z-] \&quot;){1}([0-9A-Z&amp;:] " \- \. / " \^\(\\) À È É Ì Ò Ù Û &quot; \\ / +)*</td> </tr> </tbody> </table>	Kind	Value	pattern	([0-9A-Z-] \"){1}([0-9A-Z&:] " \- \. / " \^\(\\) À È É Ì Ò Ù Û " \\ / +)*
Kind	Value				
pattern	([0-9A-Z-] \"){1}([0-9A-Z&:] " \- \. / " \^\(\\) À È É Ì Ò Ù Û " \\ / +)*				

element **Dati_Fornitore_Type/Nome**

diagram	
namespace	urn:www.agenziaentrate.gov.it:specificheTecniche:sco:730
type	DatoAN_Type

facets	Kind	Value
	pattern	(([0-9A-Z-] \"){1}([0-9A-Z&#92;] \- \., / \^\(\ \) À É È Ì Ò Ù Û \" \ \ / +)*

element Dati_Fornitore_Type/Sesso

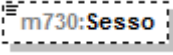
diagram		
namespace	urn:www.agenziaentrate.gov.it:specificheTecniche:sco:730	
type	Sesso_Type	
facets	Kind	Value
	pattern	(([0-9A-Z-] \"){1}([0-9A-Z&#92;] \- \., / \^\(\ \) À É È Ì Ò Ù Û \" \ \ / +)*
	enumeration	M
	enumeration	F

element Dati_Fornitore_Type/DataNascita

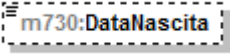
diagram		
namespace	urn:www.agenziaentrate.gov.it:specificheTecniche:sco:730	
type	DatoDT_Type	
facets	Kind	Value
	pattern	((([0-9]{1-9}){12}([0-9]{3}[01])(0[13578]{10} 2(\d{4})))(([0]{1-9}){12}([0-9]{30}(0[469]{11}(\d{4})))(([0]{1-9}){1}[0-9]{2}[0-8])(02(\d{4})))(([29](02){02468}[048]00)))(([29](02){13579}[26]00)))(([29](02){[0-9]{0-9}[0]48})))(([29](02){[0-9]{0-9}[2468][048])))(([29](02){[0-9]{0-9}[13579][26]))))

element Dati_Fornitore_Type/ComuneNascita

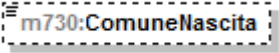
diagram		
namespace	urn:www.agenziaentrate.gov.it:specificheTecniche:sco:730	
type	DatoAN_Type	
facets	Kind	Value
	pattern	(([0-9A-Z-] \"){1}([0-9A-Z&#92;] \- \., / \^\(\ \) À É È Ì Ò Ù Û \" \ \ / +)*

element Dati_Fornitore_Type/ProvinciaNascita

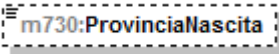
diagram		
namespace	urn:www.agenziaentrate.gov.it:specificheTecniche:sco:730	
type	PN_Type	

element Dati_Fornitore_Type/ImportoAcquisti

diagram		
---------	---	--

namespace	urn:www.agenziaentrate.gov.it:specificheTecniche:sco:730
type	DatoNP_Type
facets	Kind Value pattern [1-9]{1}[0-9]*

complexType Dati_Nascita_PF_Type

diagram	
namespace	urn:www.agenziaentrate.gov.it:specificheTecniche:sco:730
children	m730:Sesso m730:DataNascita m730:ComuneNascita m730:ProvinciaNascita

element Dati_Nascita_PF_Type/Sesso

diagram	
namespace	urn:www.agenziaentrate.gov.it:specificheTecniche:sco:730
type	Sesso_Type
facets	Kind Value pattern ([0-9A-Z-~] \"){1}([0-9A-Z&] '\-\. , /°\^\(\)\À È É ì Ò Ù Ü \" \ \\ +)* enumeration M enumeration F

element Dati_Nascita_PF_Type/DataNascita

diagram	
namespace	urn:www.agenziaentrate.gov.it:specificheTecniche:sco:730
type	DatoDT_Type
facets	Kind Value pattern ((([0-9]{1}[12][0-9]{3}[01])(0[13578][10]12)\d{4})) ((([0-9]{1}[12][0-9]{30})(0[469][11]\d{4})) (((0[1-9][1][0-9]{2}[0-8])(02)\d{4})) ((29)(02)([02468][048]00)) ((29)(02)([13579][26]00)) ((29)(02)([0-9][0][0][48])) ((29)(02)([0-9][0-9][2468][048])) ((29)(02)([0-9][0-9][13579][26]))))

element Dati_Nascita_PF_Type/ComuneNascita

diagram	
namespace	urn:www.agenziaentrate.gov.it:specificheTecniche:sco:730

type	DatoAN_Type
facets	Kind Value pattern ([0-9A-Z\-_]"){1}([0-9A-Z&#92;] \-\ \. \, / \° \^ \(\) À É È Ì Ò Ù Û " \N \+)*

element **Dati_Nascita_PF_Type/ProvinciaNascita**

diagram	
namespace	urn:www.agenziaentrate.gov.it:specificheTecniche:sco:730
type	PN_Type

complexType **Dati_Primo_Figlio_Type**

diagram	
namespace	urn:www.agenziaentrate.gov.it:specificheTecniche:sco:730
children	m730:Tipo m730:CodiceFiscale m730:Mesi m730:MesiMinore m730:PercDetraz m730:Affidamento

element **Dati_Primo_Figlio_Type/Tipo**

diagram	
namespace	urn:www.agenziaentrate.gov.it:specificheTecniche:sco:730
type	restriction of DatoAN_Type
facets	Kind Value pattern ([0-9A-Z\-_]"){1}([0-9A-Z&#92;] \-\ \. \, / \° \^ \(\) À É È Ì Ò Ù Û " \N \+)* enumeration F enumeration D

element **Dati_Primo_Figlio_Type/CodiceFiscale**

diagram	
namespace	urn:www.agenziaentrate.gov.it:specificheTecniche:sco:730
type	DatoCF_Type

facets	Kind	Value
	pattern	[0-9]{11}[A-Z]{6}[0-9LMNPQRSTUVWXYZ]{2}[A-Z]{1}[0-9LMNPQRSTUVWXYZ]{2}[A-Z]{1}[0-9LMNPQRSTUVWXYZ]{3}[A-Z]{1}

element **Dati_Primo_Figlio_Type/Mesi**

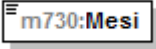
diagram																													
namespace	urn:www.agenziaentrate.gov.it:specificheTecniche:sco:730																												
type	m730:Mesi_Type																												
facets	<table border="1"> <tr> <td>Kind</td> <td>Value</td> </tr> <tr> <td>pattern</td> <td>[1-9]{1}[0-9]*</td> </tr> <tr> <td>enumeration</td> <td>1</td> </tr> <tr> <td>enumeration</td> <td>2</td> </tr> <tr> <td>enumeration</td> <td>3</td> </tr> <tr> <td>enumeration</td> <td>4</td> </tr> <tr> <td>enumeration</td> <td>5</td> </tr> <tr> <td>enumeration</td> <td>6</td> </tr> <tr> <td>enumeration</td> <td>7</td> </tr> <tr> <td>enumeration</td> <td>8</td> </tr> <tr> <td>enumeration</td> <td>9</td> </tr> <tr> <td>enumeration</td> <td>10</td> </tr> <tr> <td>enumeration</td> <td>11</td> </tr> <tr> <td>enumeration</td> <td>12</td> </tr> </table>	Kind	Value	pattern	[1-9]{1}[0-9]*	enumeration	1	enumeration	2	enumeration	3	enumeration	4	enumeration	5	enumeration	6	enumeration	7	enumeration	8	enumeration	9	enumeration	10	enumeration	11	enumeration	12
Kind	Value																												
pattern	[1-9]{1}[0-9]*																												
enumeration	1																												
enumeration	2																												
enumeration	3																												
enumeration	4																												
enumeration	5																												
enumeration	6																												
enumeration	7																												
enumeration	8																												
enumeration	9																												
enumeration	10																												
enumeration	11																												
enumeration	12																												

element **Dati_Primo_Figlio_Type/MesiMinore**

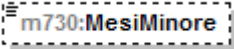
diagram																													
namespace	urn:www.agenziaentrate.gov.it:specificheTecniche:sco:730																												
type	m730:Mesi_Type																												
facets	<table border="1"> <tr> <td>Kind</td> <td>Value</td> </tr> <tr> <td>pattern</td> <td>[1-9]{1}[0-9]*</td> </tr> <tr> <td>enumeration</td> <td>1</td> </tr> <tr> <td>enumeration</td> <td>2</td> </tr> <tr> <td>enumeration</td> <td>3</td> </tr> <tr> <td>enumeration</td> <td>4</td> </tr> <tr> <td>enumeration</td> <td>5</td> </tr> <tr> <td>enumeration</td> <td>6</td> </tr> <tr> <td>enumeration</td> <td>7</td> </tr> <tr> <td>enumeration</td> <td>8</td> </tr> <tr> <td>enumeration</td> <td>9</td> </tr> <tr> <td>enumeration</td> <td>10</td> </tr> <tr> <td>enumeration</td> <td>11</td> </tr> <tr> <td>enumeration</td> <td>12</td> </tr> </table>	Kind	Value	pattern	[1-9]{1}[0-9]*	enumeration	1	enumeration	2	enumeration	3	enumeration	4	enumeration	5	enumeration	6	enumeration	7	enumeration	8	enumeration	9	enumeration	10	enumeration	11	enumeration	12
Kind	Value																												
pattern	[1-9]{1}[0-9]*																												
enumeration	1																												
enumeration	2																												
enumeration	3																												
enumeration	4																												
enumeration	5																												
enumeration	6																												
enumeration	7																												
enumeration	8																												
enumeration	9																												
enumeration	10																												
enumeration	11																												
enumeration	12																												

element **Dati_Primo_Figlio_Type/PercDetraz**

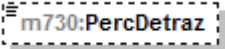
diagram					
namespace	urn:www.agenziaentrate.gov.it:specificheTecniche:sco:730				
type	DatoPC_Type				
facets	<table border="1"> <tr> <td>Kind</td> <td>Value</td> </tr> <tr> <td>pattern</td> <td>[0-9]?[0-9](,\d{1,3})? 100,(0{1,3})?</td> </tr> </table>	Kind	Value	pattern	[0-9]?[0-9](,\d{1,3})? 100,(0{1,3})?
Kind	Value				
pattern	[0-9]?[0-9](,\d{1,3})? 100,(0{1,3})?				

element

Dati_Registrazione_Accatastamento_Recupero_Patrimonio_Edilizio_Type/EstremiRegistrazioneContra
tto

diagram	<p>The diagram shows a dashed box labeled 'm730:EstremiRegistrazioneCo...' connected to a central connector box. This connector box is linked to a larger dashed box labeled 'm730:Dati_Contratto_Type'. Inside this box, six child elements are listed: m730:DataRegContratto, m730:SerieContratto, m730:NumeroContratto, m730:Sottonumero, m730:CodiceUfficio, and m730:IdentificativoContratto.</p>
namespace	urn:www.agenziaentrate.gov.it:specificheTecniche:sco:730
type	m730:Dati_Contratto_Type
children	m730:DataRegContratto m730:SerieContratto m730:NumeroContratto m730:Sottonumero m730:CodiceUfficio m730:IdentificativoContratto

element

Dati_Registrazione_Accatastamento_Recupero_Patrimonio_Edilizio_Type/DomandaAccatastamento

diagram	<p>The diagram shows a dashed box labeled 'm730:DomandaAccatastamento' connected to a central connector box. This connector box is linked to a larger dashed box labeled 'm730:Domanda_Accatastamento_Type'. Inside this box, three child elements are listed: m730:Data, m730:Numero, and m730:ProvinciaUfficio.</p>
namespace	urn:www.agenziaentrate.gov.it:specificheTecniche:sco:730
type	m730:Domanda_Accatastamento_Type
children	m730:Data m730:Numero m730:ProvinciaUfficio

complexType Dati_Rettificati_Type

diagram	<p>The diagram shows a dashed box labeled 'Dati_Rettificati_Type' connected to a central connector box. This connector box is linked to a dashed box labeled 'm730:Rettifica'. A multiplicity of '1..∞' is indicated below the 'm730:Rettifica' box.</p>
namespace	urn:www.agenziaentrate.gov.it:specificheTecniche:sco:730
children	m730:Rettifica

element Dati_Rettificati_Type/Rettifica

diagram	
namespace	urn:www.agenziaentrate.gov.it:specificheTecniche:sco:730
type	m730:Rettifica_Type
children	m730:Quadro m730:Rigo m730:Colonna m730:Modulo m730:DatoRimosso

complexType Debito_Type

diagram	
namespace	urn:www.agenziaentrate.gov.it:specificheTecniche:sco:730
children	m730:NonVersare m730:ImportoDaTrattenere

element Debito_Type/NonVersare

diagram					
namespace	urn:www.agenziaentrate.gov.it:specificheTecniche:sco:730				
type	DatoNP_Type				
facets	<table border="0"> <tr> <td>Kind</td> <td>Value</td> </tr> <tr> <td>pattern</td> <td>[1-9]{1}[0-9]*</td> </tr> </table>	Kind	Value	pattern	[1-9]{1}[0-9]*
Kind	Value				
pattern	[1-9]{1}[0-9]*				

element Debito_Type/ImportoDaTrattenere

diagram	
namespace	urn:www.agenziaentrate.gov.it:specificheTecniche:sco:730
type	DatoNP_Type

facets	Kind pattern	Value [1-9]{1}[0-9]*
--------	-----------------	-------------------------

complexType Deduzioni_Modulo_Type

diagram	
namespace	urn:www.agenziaentrate.gov.it:specificheTecniche:sco:730
children	m730:AssegnoConiuge m730:AltriOneri m730:AcquistoCostruzioneAbitLocazione

element Deduzioni_Modulo_Type/AssegnoConiuge

diagram	
namespace	urn:www.agenziaentrate.gov.it:specificheTecniche:sco:730
type	m730:Assegno_Coniuge_Type
children	m730:CodiceFiscale m730:Importo

element Deduzioni_Modulo_Type/AltriOneri

diagram	
namespace	urn:www.agenziaentrate.gov.it:specificheTecniche:sco:730
type	m730:Altri_Oneri_Type
children	m730:Codice m730:Importo

element **Deduzioni_Modulo_Type/AcquistoCostruzioneAbitLocazione**

diagram	
namespace	urn:www.agenziaentrate.gov.it:specificheTecniche:sco:730
type	m730:Acquisto Costruzione Abit Type
children	m730:DataStipula m730:Spesa m730:InteressiMutuo

complexType **Deduzioni_Type**

diagram	
namespace	urn:www.agenziaentrate.gov.it:specificheTecniche:sco:730
children	m730:ContributiPrevAss m730:AssegnoConiuge m730:ContributiColf m730:ErogazioniIstituzioniReligiose m730:SpesePortatoriHandicap m730:AltriOneri m730:DeducibilitaOrdinaria m730:LavoratoriPrimaOccupazione m730:FondiInSquilibrioFinanziario m730:FamiliariACarico m730:FondoPensioneDipendentiPubblici m730:AcquistoCostruzioneAbitLocazione m730:RestituzioneSomme

element **Deduzioni_Type/ContributiPrevAss**

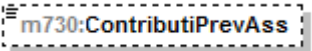
diagram	
namespace	urn:www.agenziaentrate.gov.it:specificheTecniche:sco:730
type	DatoNP_Type
facets	Kind Value pattern [1-9]{1}[0-9]*

element **Deduzioni_Type/AssegnoConiuge**

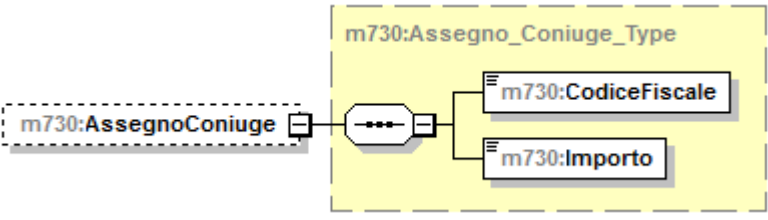
diagram	
namespace	urn:www.agenziaentrate.gov.it:specificheTecniche:sco:730
type	m730:Assegno_Coniuge_Type
children	m730:CodiceFiscale m730:Importo

element **Deduzioni_Type/ContributiColf**

diagram	
namespace	urn:www.agenziaentrate.gov.it:specificheTecniche:sco:730
type	DatoNP_Type
facets	Kind Value pattern [1-9]{1}[0-9]*

element **Deduzioni_Type/ErogazioniIstituzioniReligiose**

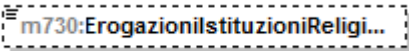
diagram	
namespace	urn:www.agenziaentrate.gov.it:specificheTecniche:sco:730
type	DatoNP_Type
facets	Kind Value pattern [1-9]{1}[0-9]*

element **Deduzioni_Type/SpesePortatoriHandicap**

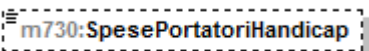
diagram	
---------	---

namespace	urn:www.agenziaentrate.gov.it:specificheTecniche:sco:730
type	DatoNP_Type
facets	Kind Value pattern [1-9]{1}[0-9]*

element **Deduzioni_Type/AltriOneri**

diagram	
namespace	urn:www.agenziaentrate.gov.it:specificheTecniche:sco:730
type	m730:Altri_Oneri_Type
children	m730:Codice m730:Importo

element **Deduzioni_Type/DeducibilitaOrdinaria**

diagram	
namespace	urn:www.agenziaentrate.gov.it:specificheTecniche:sco:730
type	m730:Contributi_Previdenza_Complementare_Type
children	m730:EsclusiDalSostituto m730:NonEsclusiDalSostituto

element **Deduzioni_Type/LavoratoriPrimaOccupazione**

diagram	
namespace	urn:www.agenziaentrate.gov.it:specificheTecniche:sco:730
type	m730:Contributi_Previdenza_Complementare_Type
children	m730:EsclusiDalSostituto m730:NonEsclusiDalSostituto

element **Deduzioni_Type/FondiInSquilibrioFinanziario**

diagram	
namespace	urn:www.agenziaentrate.gov.it:specificheTecniche:sco:730
type	m730:Contributi_Previdenza_Complementare_Type
children	m730:EsclusiDalSostituto m730:NonEsclusiDalSostituto

element **Deduzioni_Type/FamiliariACarico**

diagram	
namespace	urn:www.agenziaentrate.gov.it:specificheTecniche:sco:730
type	m730:Contributi_Previdenza_Complementare_Type
children	m730:EsclusiDalSostituto m730:NonEsclusiDalSostituto

element **Deduzioni_Type/FondoPensioneDipendentiPubblici**

diagram	
namespace	urn:www.agenziaentrate.gov.it:specificheTecniche:sco:730
type	m730:Fondo_Pensione_Dipendenti_Pubblici_Type
children	m730:Contributi m730:QuotaTFR

element **Deduzioni_Type/AcquistoCostruzioneAbitLocazione**

diagram	
namespace	urn:www.agenziaentrate.gov.it:specificheTecniche:sco:730
type	m730:Acquisto Costruzione Abit Type
children	m730:DataStipula m730:Spesa m730:InteressiMutuo

element **Deduzioni_Type/RestituzioneSomme**

diagram	
namespace	urn:www.agenziaentrate.gov.it:specificheTecniche:sco:730
type	m730:Restituzione Somme Type
children	m730:SommeRestituite m730:ResiduoPrecedenteDic

complexType **Detrazione_Crediti_Type**

<p>diagram</p>	
<p>namespace</p>	<p>urn:www.agenziaentrate.gov.it:specificheTecniche:sco:730</p>
<p>children</p>	<p>m730:DetrazioneConiuge m730:DetrazioneFigli m730:UlterioreDetrazioneFigli m730:DetrazioneFamiliari m730:DetrazioneLavDip m730:DetrazionePens m730:DetrazioneAltriRedditi m730:DetrazioneOneri m730:DetrazioneRistrutturazione m730:DetrazioniArredolmmobili m730:DetrazioneRisparmioEnergetico m730:DetrazioneArredoGiovaniCoppie m730:DetrazionelvaAcquistoAbitaz m730:DetrazioneLocEAgricoliGiovani m730:AltreDetrazioni m730:CreditoPrimaCasa m730:CreditoOccupazione m730:CreditoFondiPensione m730:CreditoMediazioni m730:CreditoNegoziazione m730:TotaleDetrazioniCrediti</p>

element **Detrazione_Crediti_Type/DetrazioneConiuge**

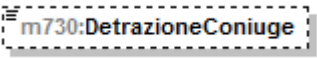
diagram	
namespace	urn:www.agenziaentrate.gov.it:specificheTecniche:sco:730
type	DatoNP_Type
facets	Kind Value pattern [1-9]{1}[0-9]*

element **Detrazione_Crediti_Type/DetrazioneFigli**

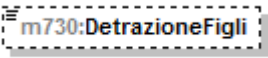
diagram	
namespace	urn:www.agenziaentrate.gov.it:specificheTecniche:sco:730
type	DatoNP_Type
facets	Kind Value pattern [1-9]{1}[0-9]*

element **Detrazione_Crediti_Type/UlterioreDetrazioneFigli**

diagram	
namespace	urn:www.agenziaentrate.gov.it:specificheTecniche:sco:730
type	DatoNP_Type
facets	Kind Value pattern [1-9]{1}[0-9]*

element **Detrazione_Crediti_Type/DetrazioneFamiliari**

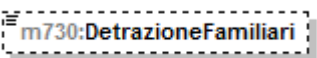
diagram	
namespace	urn:www.agenziaentrate.gov.it:specificheTecniche:sco:730
type	DatoNP_Type
facets	Kind Value pattern [1-9]{1}[0-9]*

element **Detrazione_Crediti_Type/DetrazioneLavDip**

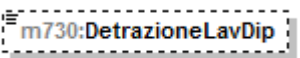
diagram	
namespace	urn:www.agenziaentrate.gov.it:specificheTecniche:sco:730
type	DatoNP_Type

facets	Kind pattern	Value [1-9]{1}[0-9]*
--------	-----------------	-------------------------

element **Detrazione_Crediti_Type/DetrazionePens**

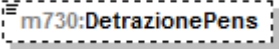
diagram		
namespace	urn:www.agenziaentrate.gov.it:specificheTecniche:sco:730	
type	DatoNP_Type	
facets	Kind pattern	Value [1-9]{1}[0-9]*

element **Detrazione_Crediti_Type/DetrazioneAltriRedditi**

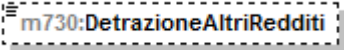
diagram		
namespace	urn:www.agenziaentrate.gov.it:specificheTecniche:sco:730	
type	DatoNP_Type	
facets	Kind pattern	Value [1-9]{1}[0-9]*

element **Detrazione_Crediti_Type/DetrazioneOneri**

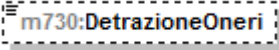
diagram		
namespace	urn:www.agenziaentrate.gov.it:specificheTecniche:sco:730	
type	DatoNP_Type	
facets	Kind pattern	Value [1-9]{1}[0-9]*

element **Detrazione_Crediti_Type/DetrazioneRistrutturazione**

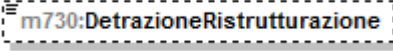
diagram		
namespace	urn:www.agenziaentrate.gov.it:specificheTecniche:sco:730	
type	DatoNP_Type	
facets	Kind pattern	Value [1-9]{1}[0-9]*

element **Detrazione_Crediti_Type/DetrazioniArredolImmobili**

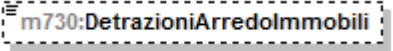
diagram		
namespace	urn:www.agenziaentrate.gov.it:specificheTecniche:sco:730	

type	DatoNP_Type
facets	Kind Value pattern [1-9]{1}[0-9]*

element **Detrazione_Crediti_Type/DetrazioneRisparmioEnergetico**

diagram	
namespace	urn:www.agenziaentrate.gov.it:specificheTecniche:sco:730
type	DatoNP_Type
facets	Kind Value pattern [1-9]{1}[0-9]*

element **Detrazione_Crediti_Type/DetrazioneArredoGiovaniCoppie**

diagram	
namespace	urn:www.agenziaentrate.gov.it:specificheTecniche:sco:730
type	DatoNP_Type
facets	Kind Value pattern [1-9]{1}[0-9]*

element **Detrazione_Crediti_Type/DetrazioneIvaAcquistoAbitaz**

diagram	
namespace	urn:www.agenziaentrate.gov.it:specificheTecniche:sco:730
type	DatoNP_Type
facets	Kind Value pattern [1-9]{1}[0-9]*

element **Detrazione_Crediti_Type/DetrazioneLocEAgricoliGiovani**

diagram	
namespace	urn:www.agenziaentrate.gov.it:specificheTecniche:sco:730
type	DatoNP_Type
facets	Kind Value pattern [1-9]{1}[0-9]*

element **Detrazione_Crediti_Type/AltreDetrazioni**

diagram	
---------	--

namespace	urn:www.agenziaentrate.gov.it:specificheTecniche:sco:730
type	DatoNP_Type
facets	Kind Value pattern [1-9]{1}[0-9]*

element **Detrazione_Crediti_Type/CreditoPrimaCasa**

diagram	
namespace	urn:www.agenziaentrate.gov.it:specificheTecniche:sco:730
type	DatoNP_Type
facets	Kind Value pattern [1-9]{1}[0-9]*

element **Detrazione_Crediti_Type/CreditoOccupazione**

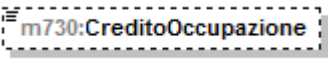
diagram	
namespace	urn:www.agenziaentrate.gov.it:specificheTecniche:sco:730
type	DatoNP_Type
facets	Kind Value pattern [1-9]{1}[0-9]*

element **Detrazione_Crediti_Type/CreditoFondiPensione**

diagram	
namespace	urn:www.agenziaentrate.gov.it:specificheTecniche:sco:730
type	DatoNP_Type
facets	Kind Value pattern [1-9]{1}[0-9]*

element **Detrazione_Crediti_Type/CreditoMediazioni**

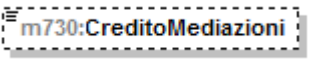
diagram	
namespace	urn:www.agenziaentrate.gov.it:specificheTecniche:sco:730
type	DatoNP_Type
facets	Kind Value pattern [1-9]{1}[0-9]*

element **Detrazione_Crediti_Type/CreditoNegoziazione**

diagram	
namespace	urn:www.agenziaentrate.gov.it:specificheTecniche:sco:730
type	DatoNP_Type
facets	Kind Value pattern [1-9]{1}[0-9]*

element **Detrazione_Crediti_Type/TotaleDetrazioniCrediti**

diagram	
namespace	urn:www.agenziaentrate.gov.it:specificheTecniche:sco:730
type	DatoNP_Type
facets	Kind Value pattern [1-9]{1}[0-9]*

complexType **Detrazioni_Canoni_Locazione_Type**

diagram	
namespace	urn:www.agenziaentrate.gov.it:specificheTecniche:sco:730
children	m730:InquiliniAbitazionePrincipale m730:DipendentiTrasferiti

element **Detrazioni_Canoni_Locazione_Type/InquiliniAbitazionePrincipale**

diagram	
namespace	urn:www.agenziaentrate.gov.it:specificheTecniche:sco:730
type	m730:Inquilini_Abitazione_Principale_Type
children	m730:Tipologia m730:GiorniPercentuale

element **Detrazioni_Canoni_Locazione_Type/DipendentiTrasferiti**

diagram	
namespace	urn:www.agenziaentrate.gov.it:specificheTecniche:sco:730
type	m730:Giorni_Percentuale_Type
children	m730:Giorni m730:Percentuale

complexType **Detrazioni_Modulo_Type**

diagram	
namespace	urn:www.agenziaentrate.gov.it:specificheTecniche:sco:730
children	m730:VeicoliDisabili m730:AcquistoCaniGuida m730:SpeseRateizzate m730:AltreSpese m730:SpeseLeasing

element **Detrazioni_Modulo_Type/VeicoliDisabili**

diagram	
namespace	urn:www.agenziaentrate.gov.it:specificheTecniche:sco:730
type	m730:Spese_Rateizzate_Type
children	m730:Codice m730:Importo

element **Detrazioni_Modulo_Type/AcquistoCaniGuida**

diagram	
namespace	urn:www.agenziaentrate.gov.it:specificheTecniche:sco:730
type	m730:Spese_Rateizzate_Type
children	m730:Codice m730:Importo

element **Detrazioni_Modulo_Type/SpeseRateizzate**

diagram	
namespace	urn:www.agenziaentrate.gov.it:specificheTecniche:sco:730
type	m730:Spese_Rateizzate_Anni_Precedenti_Type
children	m730:Codice m730:Importo

element **Detrazioni_Modulo_Type/AltreSpese**

diagram	
namespace	urn:www.agenziaentrate.gov.it:specificheTecniche:sco:730
type	m730:Altre_Spese_Type
children	m730:Codice m730:Importo

element **Detrazioni_Modulo_Type/SpeseLeasing**

diagram	
namespace	urn:www.agenziaentrate.gov.it:specificheTecniche:sco:730
type	m730:Spese_Leasing_Type
children	m730:DataStipula m730:NumeroAnno m730:Canone m730:PrezzoRiscatto

complexType **Detrazioni_Type**

diagram	
namespace	urn:www.agenziaentrate.gov.it:specificheTecniche:sco:730
children	m730:CasellaRateazione m730:SpeseDeterminatePatologie m730:SpeseSanitarie m730:SpeseFamNonACarico m730:SpeseSanitarieDisabili m730:VeicoliDisabili m730:AcquistoCaniGuida m730:SpeseRateizzate m730:MutuiAbPrincipale m730:AltreSpese m730:SpeseLeasing

element **Detrazioni_Type/CasellaRateazione**

diagram	 m730:CasellaRateazione
namespace	urn:www.agenziaentrate.gov.it:specificheTecniche:sco:730
type	DatoCB_Type
facets	Kind Value pattern [01]

element **Detrazioni_Type/SpeseDeterminatePatologie**

diagram	 m730:SpeseDeterminatePatologie
namespace	urn:www.agenziaentrate.gov.it:specificheTecniche:sco:730
type	DatoNP_Type
facets	Kind Value pattern [1-9]{1}[0-9]*

element **Detrazioni_Type/SpeseSanitarie**

diagram	 m730:Spese Sanitarie
namespace	urn:www.agenziaentrate.gov.it:specificheTecniche:sco:730
type	DatoNP_Type
facets	Kind Value pattern [1-9]{1}[0-9]*

element **Detrazioni_Type/SpeseFamNonACarico**

diagram	 m730:SpeseFamNonACarico
namespace	urn:www.agenziaentrate.gov.it:specificheTecniche:sco:730
type	DatoNP_Type
facets	Kind Value pattern [1-9]{1}[0-9]*

element **Detrazioni_Type/SpeseSanitarieDisabili**

diagram	 m730:Spese SanitarieDisabili
namespace	urn:www.agenziaentrate.gov.it:specificheTecniche:sco:730
type	DatoNP_Type
facets	Kind Value pattern [1-9]{1}[0-9]*

element **Detrazioni_Type/VeicoliDisabili**

diagram	<p>The diagram shows a class <code>m730:VeicoliDisabili</code> (dashed border) associated with a class <code>m730:Spese_Rateizzate_Type</code> (yellow background). The association is represented by a line with a solid square on the <code>m730:VeicoliDisabili</code> side and a solid circle with three dots on the <code>m730:Spese_Rateizzate_Type</code> side. Inside <code>m730:Spese_Rateizzate_Type</code>, there are two attributes: <code>m730:Codice</code> (dashed border) and <code>m730:Importo</code> (solid border).</p>
namespace	urn:www.agenziaentrate.gov.it:specificheTecniche:sco:730
type	m730:Spese_Rateizzate_Type
children	m730:Codice m730:Importo

element **Detrazioni_Type/AcquistoCaniGuida**

diagram	<p>The diagram shows a class <code>m730:AcquistoCaniGuida</code> (dashed border) associated with a class <code>m730:Spese_Rateizzate_Type</code> (yellow background). The association is represented by a line with a solid square on the <code>m730:AcquistoCaniGuida</code> side and a solid circle with three dots on the <code>m730:Spese_Rateizzate_Type</code> side. Inside <code>m730:Spese_Rateizzate_Type</code>, there are two attributes: <code>m730:Codice</code> (dashed border) and <code>m730:Importo</code> (solid border).</p>
namespace	urn:www.agenziaentrate.gov.it:specificheTecniche:sco:730
type	m730:Spese_Rateizzate_Type
children	m730:Codice m730:Importo

element **Detrazioni_Type/SpeseRateizzate**

diagram	<p>The diagram shows a class <code>m730:SpeseRateizzate</code> (dashed border) associated with a class <code>m730:Spese_Rateizzate_Anni_Precedenti_Type</code> (yellow background). The association is represented by a line with a solid square on the <code>m730:SpeseRateizzate</code> side and a solid circle with three dots on the <code>m730:Spese_Rateizzate_Anni_Precedenti_Type</code> side. Inside <code>m730:Spese_Rateizzate_Anni_Precedenti_Type</code>, there are two attributes: <code>m730:Codice</code> (solid border) and <code>m730:Importo</code> (solid border).</p>
namespace	urn:www.agenziaentrate.gov.it:specificheTecniche:sco:730
type	m730:Spese_Rateizzate_Anni_Precedenti_Type
children	m730:Codice m730:Importo

element **Detrazioni_Type/MutuiAbPrincipale**

diagram	<p>The diagram shows a single class <code>m730:MutuiAbPrincipale</code> (dashed border).</p>
namespace	urn:www.agenziaentrate.gov.it:specificheTecniche:sco:730

type	DatoNP_Type
facets	Kind Value pattern [1-9]{1}[0-9]*

element **Detrazioni_Type/AltreSpese**

diagram	
namespace	urn:www.agenziaentrate.gov.it:specificheTecniche:sco:730
type	m730:Altre_Spese_Type
children	m730:Codice m730:Importo

element **Detrazioni_Type/SpeseLeasing**

diagram	
namespace	urn:www.agenziaentrate.gov.it:specificheTecniche:sco:730
type	m730:Spese_Leasing_Type
children	m730:DataStipula m730:NumeroAnno m730:Canone m730:PrezzoRiscatto

complexType **Dichiarazione_Con_Type**

diagram	
namespace	urn:www.agenziaentrate.gov.it:specificheTecniche:sco:730

children	m730:Frontespizio m730:DatiContabili m730:FuoriAssistenzaQuadri m730:Scelte
----------	---

element **Dichiarazione_Con_Type/Frontespizio**

diagram	
namespace	urn:www.agenziaentrate.gov.it:specificheTecniche:sco:730
type	m730:Frontespizio_Con_Type
children	m730:SoggettoFiscale m730:DatiAnagrafici m730:StatoCivile m730:ResidenzaAnagrafica m730:DomicilioFiscaleSaldo m730:DomicilioFiscaleAcconto m730:CasiParticolariAddizionale m730:Firma

element **Dichiarazione_Con_Type/DatiContabili**

<p>diagram</p>	
<p>namespace</p>	<p>urn:www.agenziaentrate.gov.it:specificheTecniche:sco:730</p>
<p>type</p>	<p>m730:Dati_Contabili_Type</p>
<p>children</p>	<p>m730:Familiari m730:QuadroA m730:QuadroB m730:QuadroC m730:QuadroD m730:QuadroE m730:QuadroF m730:QuadroG m730:QuadroI m730:ProspettoLiquidazione m730:Prospetto_Anotazioni m730:QuadroK</p>

element **Dichiarazione_Con_Type/FuoriAssistenzaQuadri**

diagram	
namespace	urn:www.agenziaentrate.gov.it:specificheTecniche:sco:730
type	m730:Fuori_Assistenza_Type
children	m730:AnomaliaDatianagrafici m730:AnomaliaTerreni m730:AnomaliaFabbricati m730:AnomaliaLavDip m730:AnomaliaAltriRedditi m730:AnomaliaQuadroF

element **Dichiarazione_Con_Type/Scelte**

diagram	
namespace	urn:www.agenziaentrate.gov.it:specificheTecniche:sco:730
type	sce:Scelte_Type
children	sce:Scelta5PerMille sce:Scelta8PerMille sce:Scelta2PerMille

complexType **Dichiarazione_Dich_Type**

diagram	
---------	--

namespace	urn:www.agenziaentrate.gov.it:specificheTecniche:sco:730
children	m730:Frontespizio m730:DatiContabili m730:FuoriAssistenza m730:Scelte

element **Dichiarazione_Dich_Type/**Frontespizio

diagram	
namespace	urn:www.agenziaentrate.gov.it:specificheTecniche:sco:730
type	extension of m730:Frontespizio Dich_Type
children	m730:SoggettoFiscale m730:DatiAnagrafici m730:StatoCivile m730:ResidenzaAnagrafica m730:DomicilioFiscaleSaldo m730:DomicilioFiscaleAcconto m730:CasiParticolariAddizionale m730:Firma m730:Rappresentante

element Dichiarazione_Dich_Type/DatiContabili

<p>diagram</p>	
<p>namespace</p>	<p>urn:www.agenziaentrate.gov.it:specificheTecniche:sco:730</p>
<p>type</p>	<p>m730:Dati_Contabili_Type</p>
<p>children</p>	<p>m730:Familiari m730:QuadroA m730:QuadroB m730:QuadroC m730:QuadroD m730:QuadroE m730:QuadroF m730:QuadroG m730:QuadroI m730:ProspettoLiquidazione m730:Prospetto_Annotazioni m730:QuadroK</p>

element Dichiarazione_Dich_Type/FuoriAssistenza

<p>diagram</p>	
<p>namespace</p>	<p>urn:www.agenziaentrate.gov.it:specificheTecniche:sco:730</p>
<p>children</p>	<p>m730:FuoriAssistenzaQuadri m730:AnomaliaDatiSostituto m730:AnomaliaDatiRappresentante</p>

element **Dichiarazione_Dich_Type/FuoriAssistenza/FuoriAssistenzaQuadri**

diagram	
namespace	urn:www.agenziaentrate.gov.it:specificheTecniche:sco:730
type	m730:Fuori_Assistenza_Type
children	m730:AnomaliaDatianagrafici m730:AnomaliaTerreni m730:AnomaliaFabbricati m730:AnomaliaLavDip m730:AnomaliaAltriRedditi m730:AnomaliaQuadroF

element **Dichiarazione_Dich_Type/FuoriAssistenza/AnomaliaDatiSostituto**

diagram					
namespace	urn:www.agenziaentrate.gov.it:specificheTecniche:sco:730				
type	DatoCB_Type				
facets	<table border="1"> <tr> <td>Kind</td> <td>Value</td> </tr> <tr> <td>pattern</td> <td>[01]</td> </tr> </table>	Kind	Value	pattern	[01]
Kind	Value				
pattern	[01]				

element **Dichiarazione_Dich_Type/FuoriAssistenza/AnomaliaDatiRappresentante**

diagram					
namespace	urn:www.agenziaentrate.gov.it:specificheTecniche:sco:730				
type	DatoCB_Type				
facets	<table border="1"> <tr> <td>Kind</td> <td>Value</td> </tr> <tr> <td>pattern</td> <td>[01]</td> </tr> </table>	Kind	Value	pattern	[01]
Kind	Value				
pattern	[01]				

element **Dichiarazione_Dich_Type/Scelte**

diagram	
namespace	urn:www.agenziaentrate.gov.it:specificheTecniche:sco:730
type	sce:Scelte_Type
children	sce:Scelta5PerMille sce:Scelta8PerMille sce:Scelta2PerMille

complexType **Documento_730-4**

diagram	
namespace	urn:www.agenziaentrate.gov.it:specificheTecniche:sco:730
children	m730:DatiAnagraficiDichiarante m730:Sostituto m730:SoggettoAssFiscale730-4 m730:AltriDati m730:DatiContabili730-4

element Documento_730-4/DatiAnagraficiDichiarante

diagram	
namespace	urn:www.agenziaentrate.gov.it:specificheTecniche:sco:730
type	extension of Dati_Anagrafici_Type
children	Cognome Nome Sesso DataNascita ComuneNascita ProvinciaNascita m730:CFDichiarante

element Documento_730-4/DatiAnagraficiDichiarante/CFDichiarante

diagram					
namespace	urn:www.agenziaentrate.gov.it:specificheTecniche:sco:730				
type	DatoCF_Type				
facets	<table border="1"> <thead> <tr> <th>Kind</th> <th>Value</th> </tr> </thead> <tbody> <tr> <td>pattern</td> <td>[0-9]{11}[A-Z]{6}[0-9LMNPQRSTUUV]{2}[A-Z]{1}[0-9LMNPQRSTUUV]{2}[A-Z]{1}[0-9LMNPQRSTUUV]{3}[A-Z]{1}</td> </tr> </tbody> </table>	Kind	Value	pattern	[0-9]{11}[A-Z]{6}[0-9LMNPQRSTUUV]{2}[A-Z]{1}[0-9LMNPQRSTUUV]{2}[A-Z]{1}[0-9LMNPQRSTUUV]{3}[A-Z]{1}
Kind	Value				
pattern	[0-9]{11}[A-Z]{6}[0-9LMNPQRSTUUV]{2}[A-Z]{1}[0-9LMNPQRSTUUV]{2}[A-Z]{1}[0-9LMNPQRSTUUV]{3}[A-Z]{1}				

element **Documento_730-4/Sostituto**

diagram	
namespace	urn:www.agenziaentrate.gov.it:specificheTecniche:sco:730
type	m730:Sostituto_Type
children	m730:CodiceFiscale m730:DatiAnagraficiPF m730:DenominazionePNF m730:Residenza m730:Fax m730:CodiceSede

element **Documento_730-4/SoggettoAssFiscale730-4**

diagram	
namespace	urn:www.agenziaentrate.gov.it:specificheTecniche:sco:730
children	m730:DatiCaf730-4 m730:DatiProfessionista730-4 m730:DatiAssociazione730-4 m730:DatiAgenzia730-4

element **Documento_730-4/SoggettoAssFiscale730-4/DatiCaf730-4**

diagram	
namespace	urn:www.agenziaentrate.gov.it:specificheTecniche:sco:730
type	extension of m730:Dati_CAF_Type
children	m730:CFCaf m730:DenominazioneCaf m730:NumeroAlbo m730:DomicilioCaf m730:UfficioPerifericoCaf

element **Documento_730-4/SoggettoAssFiscale730-4/DatiCaf730-4/DomicilioCaf**

diagram	
namespace	urn:www.agenziaentrate.gov.it:specificheTecniche:sco:730
type	m730:Domicilio_Sogg_Ass_Fiscale_Type
children	m730:Comune m730:Provincia m730:CodiceComune m730:Cap m730:Indirizzo m730:Telefono m730:FAX m730:Email

element **Documento_730-4/SoggettoAssFiscale730-4/DatiCaf730-4/UfficioPerifericoCaf**

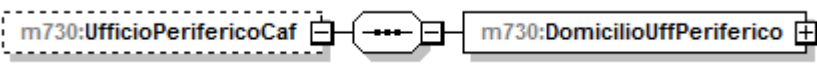
diagram	
namespace	urn:www.agenziaentrate.gov.it:specificheTecniche:sco:730
children	m730:DomicilioUffPeriferico

element **Documento_730-4/SoggettoAssFiscale730-4/DatiCaf730-4/UfficioPerifericoCaf/DomicilioUffPeriferico**

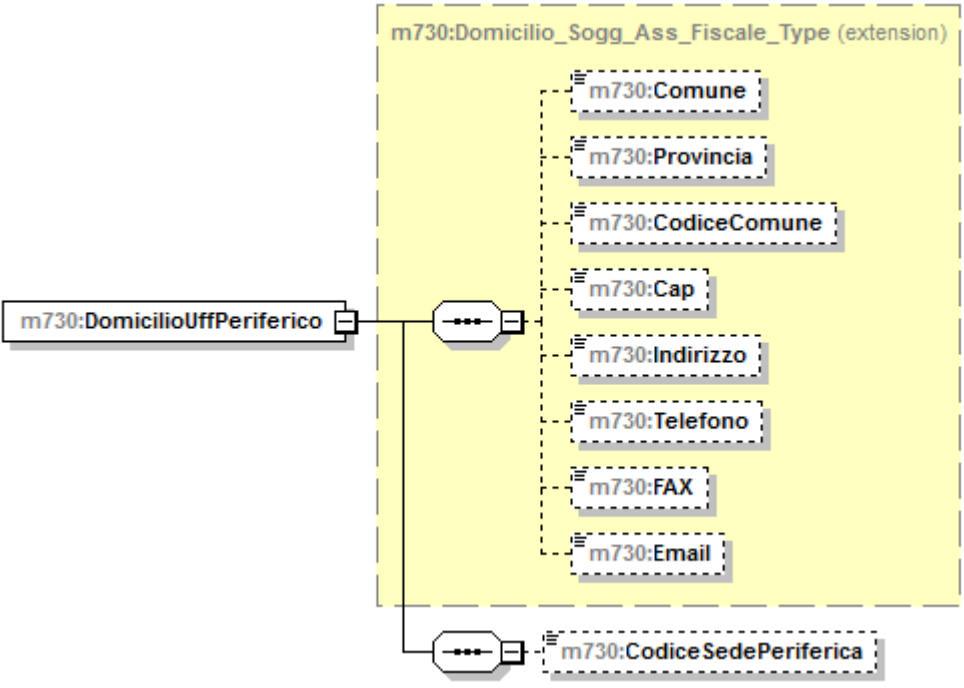
diagram	
namespace	urn:www.agenziaentrate.gov.it:specificheTecniche:sco:730
type	extension of m730:Domicilio_Sogg_Ass_Fiscale_Type
children	m730:Comune m730:Provincia m730:CodiceComune m730:Cap m730:Indirizzo m730:Telefono m730:FAX m730:Email m730:CodiceSedePeriferica

element **Documento_730-4/SoggettoAssFiscale730-4/DatiCaf730-4/UfficioPerifericoCaf/DomicilioUffPeriferico/CodiceSedePeriferica**

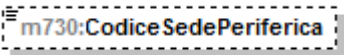
diagram					
namespace	urn:www.agenziaentrate.gov.it:specificheTecniche:sco:730				
type	DatoAN_Type				
facets	<table border="1"> <thead> <tr> <th>Kind</th> <th>Value</th> </tr> </thead> <tbody> <tr> <td>pattern</td> <td>([0-9A-Z\-\-]&quot;){1}([0-9A-Z&amp; ; ! \- \- . / ° °\(\ \)À È É Ì Ò Ù Û &quot; \N\ +)*</td> </tr> </tbody> </table>	Kind	Value	pattern	([0-9A-Z\-\-]"){1}([0-9A-Z& ; ! \- \- . / ° °\(\ \)À È É Ì Ò Ù Û " \N\ +)*
Kind	Value				
pattern	([0-9A-Z\-\-]"){1}([0-9A-Z& ; ! \- \- . / ° °\(\ \)À È É Ì Ò Ù Û " \N\ +)*				

element **Documento_730-4/SoggettoAssFiscale730-4/DatiProfessionista730-4**

diagram	<p>The diagram shows a class <code>m730:DatiProfessionista730-4</code> extending the class <code>m730:Dati_Professionista_Type (extension)</code>. The extension includes four child elements: <code>m730:CFProfessionista</code>, <code>m730:CognomeProfessionista</code>, <code>m730:NomeProfessionista</code>, and <code>m730:DomicilioProf</code>.</p>
namespace	urn:www.agenziaentrate.gov.it:specificheTecniche:sco:730
type	extension of m730:Dati Professionista Type
children	m730:CFProfessionista m730:CognomeProfessionista m730:NomeProfessionista m730:DomicilioProf

element **Documento_730-4/SoggettoAssFiscale730-4/DatiProfessionista730-4/DomicilioProf**

diagram	<p>The diagram shows a class <code>m730:DomicilioProf</code> extending the class <code>m730:Domicilio_Sogg_Ass_Fiscale_Type</code>. The extension includes eight child elements: <code>m730:Comune</code>, <code>m730:Provincia</code>, <code>m730:CodiceComune</code>, <code>m730:Cap</code>, <code>m730:Indirizzo</code>, <code>m730:Telefono</code>, <code>m730:FAX</code>, and <code>m730:Email</code>.</p>
namespace	urn:www.agenziaentrate.gov.it:specificheTecniche:sco:730
type	m730:Domicilio Sogg Ass Fiscale Type
children	m730:Comune m730:Provincia m730:CodiceComune m730:Cap m730:Indirizzo m730:Telefono m730:FAX m730:Email

element **Documento_730-4/SoggettoAssFiscale730-4/DatiAssociazione730-4**

diagram	
namespace	urn:www.agenziaentrate.gov.it:specificheTecniche:sco:730
type	extension of m730:Dati_Associazioni_Professionale_Type
children	m730:CFAssociazione m730:DenominazioneAssociazione m730:CFProfessionista m730:CognomeProfessionista m730:NomeProfessionista m730:DomicilioAssociazione

element **Documento_730-4/SoggettoAssFiscale730-4/DatiAssociazione730-4/DomicilioAssociazione**

diagram	
namespace	urn:www.agenziaentrate.gov.it:specificheTecniche:sco:730
type	m730:Domicilio_Sogg_Ass_Fiscale_Type
children	m730:Comune m730:Provincia m730:CodiceComune m730:Cap m730:Indirizzo m730:Telefono m730:FAX m730:Email

element Documento_730-4/SoggettoAssFiscale730-4/DatiAgenzia730-4

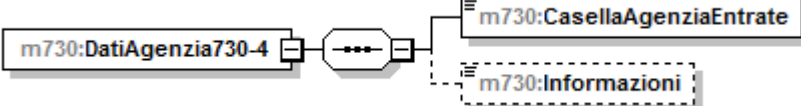
diagram	
namespace	urn:www.agenziaentrate.gov.it:specificheTecniche:sco:730
children	m730:CasellaAgenziaEntrate m730:Informazioni

element Documento_730-4/SoggettoAssFiscale730-4/DatiAgenzia730-4/CasellaAgenziaEntrate

diagram	
namespace	urn:www.agenziaentrate.gov.it:specificheTecniche:sco:730
type	DatoCB_Type
facets	Kind Value pattern [01]

element Documento_730-4/SoggettoAssFiscale730-4/DatiAgenzia730-4/Informazioni

diagram	
namespace	urn:www.agenziaentrate.gov.it:specificheTecniche:sco:730
type	DatoAN_Type
facets	Kind Value pattern ([0-9A-Z- "}{1}{[0-9A-Z&:] ' - \., / ° ^\(\\(\) À È É Ì Ò Ù Û " \\ / +)*

element Documento_730-4/AltriDati

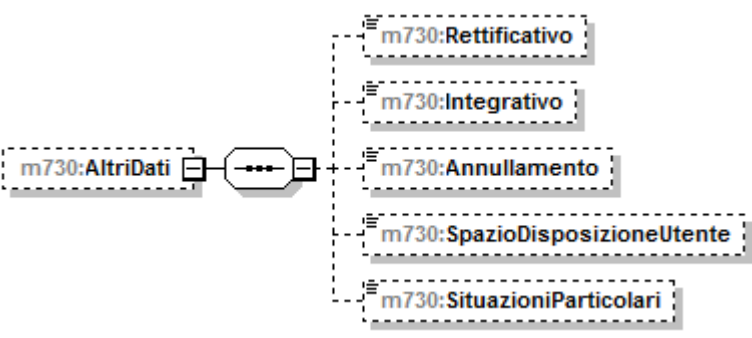
diagram	
namespace	urn:www.agenziaentrate.gov.it:specificheTecniche:sco:730
children	m730:Rettificativo m730:Integrativo m730:Annullamento m730:SpazioDisposizioneUtente m730:SituazioniParticolari

element **Documento_730-4/AltriDati/Rettificativo**

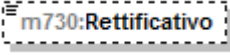
diagram											
namespace	urn:www.agenziaentrate.gov.it:specificheTecniche:sco:730										
type	m730:Rettificativo_Type										
facets	<table border="1"> <thead> <tr> <th>Kind</th> <th>Value</th> </tr> </thead> <tbody> <tr> <td>pattern</td> <td>[1-9]</td> </tr> <tr> <td>enumeration</td> <td>1</td> </tr> <tr> <td>enumeration</td> <td>2</td> </tr> <tr> <td>enumeration</td> <td>3</td> </tr> </tbody> </table>	Kind	Value	pattern	[1-9]	enumeration	1	enumeration	2	enumeration	3
Kind	Value										
pattern	[1-9]										
enumeration	1										
enumeration	2										
enumeration	3										

element **Documento_730-4/AltriDati/Integrativo**

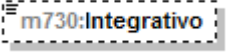
diagram											
namespace	urn:www.agenziaentrate.gov.it:specificheTecniche:sco:730										
type	m730:Integrativo_Type										
facets	<table border="1"> <thead> <tr> <th>Kind</th> <th>Value</th> </tr> </thead> <tbody> <tr> <td>pattern</td> <td>[1-9]</td> </tr> <tr> <td>enumeration</td> <td>1</td> </tr> <tr> <td>enumeration</td> <td>2</td> </tr> <tr> <td>enumeration</td> <td>3</td> </tr> </tbody> </table>	Kind	Value	pattern	[1-9]	enumeration	1	enumeration	2	enumeration	3
Kind	Value										
pattern	[1-9]										
enumeration	1										
enumeration	2										
enumeration	3										

element **Documento_730-4/AltriDati/Annullamento**

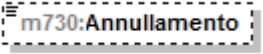
diagram					
namespace	urn:www.agenziaentrate.gov.it:specificheTecniche:sco:730				
type	DatoCB_Type				
facets	<table border="1"> <thead> <tr> <th>Kind</th> <th>Value</th> </tr> </thead> <tbody> <tr> <td>pattern</td> <td>[01]</td> </tr> </tbody> </table>	Kind	Value	pattern	[01]
Kind	Value				
pattern	[01]				

element **Documento_730-4/AltriDati/SpazioDisposizioneUtente**

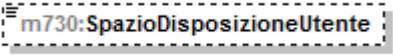
diagram					
namespace	urn:www.agenziaentrate.gov.it:specificheTecniche:sco:730				
type	DatoAN_Type				
facets	<table border="1"> <thead> <tr> <th>Kind</th> <th>Value</th> </tr> </thead> <tbody> <tr> <td>pattern</td> <td>(([0-9A-Z-] \&quot;){1}([0-9A-Z&amp;] " \- \., / "^\(\\) À É È Ì Ò Ù Û &quot; \\ \\ +)*</td> </tr> </tbody> </table>	Kind	Value	pattern	(([0-9A-Z-] \"){1}([0-9A-Z&] " \- \., / "^\(\\) À É È Ì Ò Ù Û " \\ \\ +)*
Kind	Value				
pattern	(([0-9A-Z-] \"){1}([0-9A-Z&] " \- \., / "^\(\\) À É È Ì Ò Ù Û " \\ \\ +)*				

element **Documento_730-4/AltriDati/SituazioniParticolari**

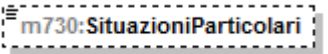
diagram	
namespace	urn:www.agenziaentrate.gov.it:specificheTecniche:sco:730

type	DatoNP_Type
facets	Kind Value pattern [1-9]{1}[0-9]*

element **Documento_730-4/DatiContabili730-4**

diagram	
namespace	urn:www.agenziaentrate.gov.it:specificheTecniche:sco:730
children	m730:Ordinario_730-4 m730:Integrativo_730-4

element **Documento_730-4/DatiContabili730-4/Ordinario_730-4**

diagram	
namespace	urn:www.agenziaentrate.gov.it:specificheTecniche:sco:730
children	m730:ImportiTrattenere m730:ImportiRimborsare m730:Conguaglio

element Documento_730-4/DatiContabili730-4/Ordinario_730-4/ImportiTrattenere

<p>diagram</p>	
<p>namespace</p>	<p>urn:www.agenziaentrate.gov.it:specificheTecniche:sco:730</p>
<p>type</p>	<p>m730:Importi_Trattenere_730-4_Type</p>
<p>children</p>	<p>m730:IrpefTrattenere m730:AddRegTrattenere m730:AddComTrattenere m730:IrpefPrimaRataTrattenere m730:IrpefSecondaRataTrattenere m730:TassSepAccontoTrattenere m730:AddComAccontoTrattenere m730:PremiRisultatoTrattenere m730:CedolareTrattenere m730:CedolarePrimaRataTrattenere m730:CedolareSecondaRataTrattenere m730:ContribSolidTrattenere</p>

element Documento_730-4/DatiContabili730-4/Ordinario_730-4/ImportiRimborsare

<p>diagram</p>	
<p>namespace</p>	<p>urn:www.agenziaentrate.gov.it:specificheTecniche:sco:730</p>

type	m730:Importi Rimborsare 730-4 Type
children	m730:IrpefRimborsare m730:AddRegRimborsare m730:AddComRimborsare m730:CedolareRimborsare

element **Documento_730-4/DatiContabili730-4/Ordinario_730-4/Conguaglio**

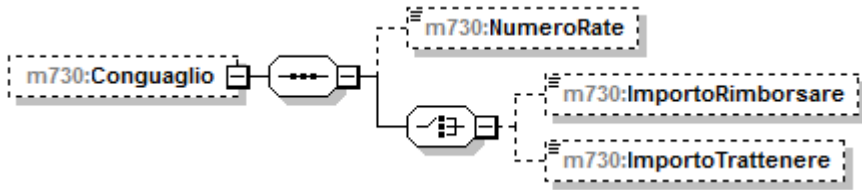
diagram	
namespace	urn:www.agenziaentrate.gov.it:specificheTecniche:sco:730
children	m730:NumeroRate m730:ImportoRimborsare m730:ImportoTrattenere

element **Documento_730-4/DatiContabili730-4/Ordinario_730-4/Conguaglio/NumeroRate**

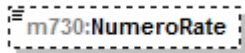
diagram	
namespace	urn:www.agenziaentrate.gov.it:specificheTecniche:sco:730
type	DatoN1 Type
facets	Kind Value pattern [1-9]

element **Documento_730-4/DatiContabili730-4/Ordinario_730-4/Conguaglio/ImportoRimborsare**

diagram	
namespace	urn:www.agenziaentrate.gov.it:specificheTecniche:sco:730
type	DatoNP Type
facets	Kind Value pattern [1-9]{1}[0-9]*

element **Documento_730-4/DatiContabili730-4/Ordinario_730-4/Conguaglio/ImportoTrattenere**

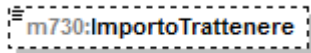
diagram	
namespace	urn:www.agenziaentrate.gov.it:specificheTecniche:sco:730
type	DatoNP Type
facets	Kind Value pattern [1-9]{1}[0-9]*

element **Documento_730-4/DatiContabili730-4/Integrativo_730-4**

diagram	
namespace	urn:www.agenziaentrate.gov.it:specificheTecniche:sco:730
children	m730:ImportiRimborsare

element **Documento_730-4/DatiContabili730-4/Integrativo_730-4/ImportiRimborsare**

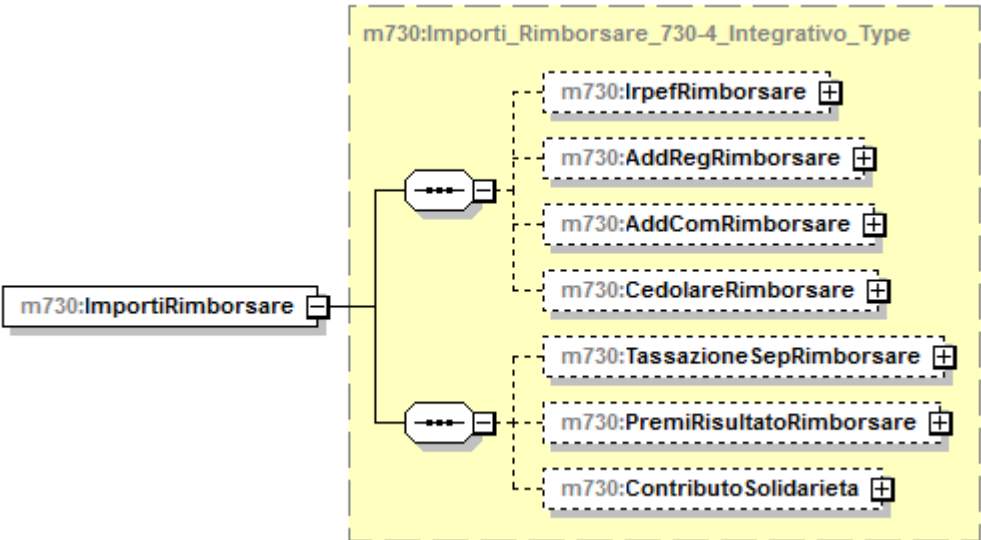
diagram	
namespace	urn:www.agenziaentrate.gov.it:specificheTecniche:sco:730
type	m730:Importi_Rimborsare_730-4_Integrativo_Type
children	m730:IrpefRimborsare m730:AddRegRimborsare m730:AddComRimborsare m730:CedolareRimborsare m730:TassazioneSepRimborsare m730:PremiRisultatoRimborsare m730:ContributoSolidarieta

complexType Documento_730_Type

diagram					
namespace	urn:www.agenziaentrate.gov.it:specificheTecniche:sco:730				
type	extension of Documento_Type				
children	m730:DichiarazioneDich m730:DichiarazioneCon m730:AltriDati m730:Sostituto m730:Mod730DipendentiSenzaSostituto m730:SoggettoAssFiscaleDoc m730:Documento_730-4 m730:EsitiContabili m730:DatiRettificati				
attributes	Name	Type	Use	Default	Fixed
	identificativo	Identificativo_Type	required		

element Documento_730_Type/DichiarazioneDich

diagram					
namespace	urn:www.agenziaentrate.gov.it:specificheTecniche:sco:730				

type	m730:Dichiarazione Dich Type
children	m730:Frontespizio m730:DatiContabili m730:FuoriAssistenza m730:Scelte

element **Documento_730_Type/DichiarazioneCon**

diagram	
namespace	urn:www.agenziaentrate.gov.it:specificheTecniche:sco:730
type	m730:Dichiarazione Con Type
children	m730:Frontespizio m730:DatiContabili m730:FuoriAssistenzaQuadri m730:Scelte

element **Documento_730_Type/AltriDati**

diagram	
namespace	urn:www.agenziaentrate.gov.it:specificheTecniche:sco:730

children	m730:FlagConferma m730:FlagAssenzaDati730-4 m730:FlagCfErratoDicTrasmessa m730:Rettificativo m730:Integrativo m730:CfProduttoreSoftware m730:SpazioDisposizioneUtente m730:DichiarazioneCongiunta m730:SituazioniParticolari m730:Mod730SenzaSostituto m730:ComunicazioneDatiRettificati m730:SostCafProfessNonDelegato
----------	---

element **Documento_730_Type/AltriDati/FlagConferma**

diagram	
namespace	urn:www.agenziaentrate.gov.it:specificheTecniche:sco:730
type	DatoCB_Type
facets	Kind Value pattern [01]

element **Documento_730_Type/AltriDati/FlagAssenzaDati730-4**

diagram	
namespace	urn:www.agenziaentrate.gov.it:specificheTecniche:sco:730
type	DatoCB_Type
facets	Kind Value pattern [01]

element **Documento_730_Type/AltriDati/FlagCfErratoDicTrasmessa**

diagram	
namespace	urn:www.agenziaentrate.gov.it:specificheTecniche:sco:730
type	DatoCF_Type
facets	Kind Value pattern [0-9]{11}[A-Z]{6}[0-9LMNPQRSTUUV]{2}[A-Z]{1}[0-9LMNPQRSTUUV]{2}[A-Z]{1}[0-9LMNPQRSTUUV]{3}[A-Z]{1}

element **Documento_730_Type/AltriDati/Rettificativo**

diagram	
namespace	urn:www.agenziaentrate.gov.it:specificheTecniche:sco:730
type	m730:Rettificativo_Type
facets	Kind Value pattern [1-9] enumeration 1 enumeration 2 enumeration 3

element **Documento_730_Type/AltriDati/Integrativo**

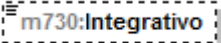
diagram											
namespace	urn:www.agenziaentrate.gov.it:specificheTecniche:sco:730										
type	m730:Integrativo_Type										
facets	<table border="1"> <thead> <tr> <th>Kind</th> <th>Value</th> </tr> </thead> <tbody> <tr> <td>pattern</td> <td>[1-9]</td> </tr> <tr> <td>enumeration</td> <td>1</td> </tr> <tr> <td>enumeration</td> <td>2</td> </tr> <tr> <td>enumeration</td> <td>3</td> </tr> </tbody> </table>	Kind	Value	pattern	[1-9]	enumeration	1	enumeration	2	enumeration	3
Kind	Value										
pattern	[1-9]										
enumeration	1										
enumeration	2										
enumeration	3										

element **Documento_730_Type/AltriDati/CfProduttoreSoftware**

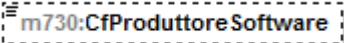
diagram					
namespace	urn:www.agenziaentrate.gov.it:specificheTecniche:sco:730				
type	DatoCF_Type				
facets	<table border="1"> <thead> <tr> <th>Kind</th> <th>Value</th> </tr> </thead> <tbody> <tr> <td>pattern</td> <td>[0-9]{11}[A-Z]{6}[0-9LMNPQRSTUVWXYZ]{2}[A-Z]{1}[0-9LMNPQRSTUVWXYZ]{2}[A-Z]{1}[0-9LMNPQRSTUVWXYZ]{3}[A-Z]{1}</td> </tr> </tbody> </table>	Kind	Value	pattern	[0-9]{11}[A-Z]{6}[0-9LMNPQRSTUVWXYZ]{2}[A-Z]{1}[0-9LMNPQRSTUVWXYZ]{2}[A-Z]{1}[0-9LMNPQRSTUVWXYZ]{3}[A-Z]{1}
Kind	Value				
pattern	[0-9]{11}[A-Z]{6}[0-9LMNPQRSTUVWXYZ]{2}[A-Z]{1}[0-9LMNPQRSTUVWXYZ]{2}[A-Z]{1}[0-9LMNPQRSTUVWXYZ]{3}[A-Z]{1}				

element **Documento_730_Type/AltriDati/SpazioDisposizioneUtente**

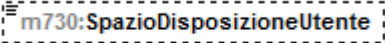
diagram					
namespace	urn:www.agenziaentrate.gov.it:specificheTecniche:sco:730				
type	DatoAN_Type				
facets	<table border="1"> <thead> <tr> <th>Kind</th> <th>Value</th> </tr> </thead> <tbody> <tr> <td>pattern</td> <td>(([0-9A-Z-] \&quot;){1}([0-9A-Z&amp;:] \- \., / \^ \(\) \) \) \&Egrave;\) \&Ograve;\) \&Ugrave;\) \&quot; \ \\ \ +)*</td> </tr> </tbody> </table>	Kind	Value	pattern	(([0-9A-Z-] \"){1}([0-9A-Z&:] \- \., / \^ \(\) \) \) \È\) \Ò\) \Ù\) \" \ \\ \ +)*
Kind	Value				
pattern	(([0-9A-Z-] \"){1}([0-9A-Z&:] \- \., / \^ \(\) \) \) \È\) \Ò\) \Ù\) \" \ \\ \ +)*				

element **Documento_730_Type/AltriDati/DichiarazioneCongiunta**

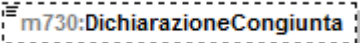
diagram					
namespace	urn:www.agenziaentrate.gov.it:specificheTecniche:sco:730				
type	DatoCB_Type				
facets	<table border="1"> <thead> <tr> <th>Kind</th> <th>Value</th> </tr> </thead> <tbody> <tr> <td>pattern</td> <td>[01]</td> </tr> </tbody> </table>	Kind	Value	pattern	[01]
Kind	Value				
pattern	[01]				

element **Documento_730_Type/AltriDati/SituazioniParticolari**

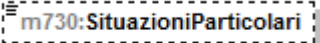
diagram	
namespace	urn:www.agenziaentrate.gov.it:specificheTecniche:sco:730
type	DatoNP_Type

facets	Kind	Value
	pattern	[1-9]{1}[0-9]*

element **Documento_730_Type/AltriDati/Mod730SenzaSostituto**

diagram		
namespace	urn:www.agenziaentrate.gov.it:specificheTecniche:sco:730	
type	restriction of DatoAN_Type	
facets	Kind	Value
	pattern	(([0-9A-Z\-\-]"){1}([0-9A-Z&:] '\- \., / \° \^ \(\) À È É Ì Ò Ù Û "; \\ / +)*
	enumeration	A

element **Documento_730_Type/AltriDati/ComunicazioneDatiRettificati**

diagram		
namespace	urn:www.agenziaentrate.gov.it:specificheTecniche:sco:730	
type	DatoCB_Type	
facets	Kind	Value
	pattern	[01]

element **Documento_730_Type/AltriDati/SostCafProfessNonDelegato**

diagram		
namespace	urn:www.agenziaentrate.gov.it:specificheTecniche:sco:730	
type	DatoCB_Type	
facets	Kind	Value
	pattern	[01]

element **Documento_730_Type/Sostituto**

diagram	
namespace	urn:www.agenziaentrate.gov.it:specificheTecniche:sco:730
type	m730:Sostituto_Type
children	m730:CodiceFiscale m730:DatiAnagraficiPF m730:DenominazionePNF m730:Residenza m730:Fax m730:CodiceSede

element **Documento_730_Type/Mod730DipendentiSenzaSostituto**

diagram					
namespace	urn:www.agenziaentrate.gov.it:specificheTecniche:sco:730				
type	DatoCB_Type				
facets	<table border="1"> <thead> <tr> <th>Kind</th> <th>Value</th> </tr> </thead> <tbody> <tr> <td>pattern</td> <td>[01]</td> </tr> </tbody> </table>	Kind	Value	pattern	[01]
Kind	Value				
pattern	[01]				

element **Documento_730_Type/SoggettoAssFiscaleDoc**

diagram	
namespace	urn:www.agenziaentrate.gov.it:specificheTecniche:sco:730
type	m730:Soggetto_Assistenza_Fiscale_Doc_Type
children	m730:DataConsegna m730:TipologiaSoggettoAssFisc m730:SostitutoCF m730:DatiCafDoc m730:DatiProfessionistaDoc m730:DatiAssociazioneDoc m730:AgenziaEntrate

element **Documento_730_Type/Documento_730-4**

diagram	
namespace	urn:www.agenziaentrate.gov.it:specificheTecniche:sco:730
type	m730:Documento_730-4
children	m730:DatiAnagraficiDichiarante m730:Sostituto m730:SoggettoAssFiscale730-4 m730:AltriDati m730:DatiContabili730-4

element **Documento_730_Type/EsitiContabili**

diagram	<p>The diagram shows a container element m730:EsitiContabili (dashed box) connected to a connector element (hexagon with three dots). This connector is linked to three child elements: m730:Conguaglio, m730:Mod730Integrativo, and m730:VersamentiF24, all shown in dashed boxes.</p>
namespace	urn:www.agenziaentrate.gov.it:specificheTecniche:sco:730
children	m730:Conguaglio m730:Mod730Integrativo m730:VersamentiF24

element **Documento_730_Type/EsitiContabili/Conguaglio**

diagram	<p>The diagram shows a container element m730:Conguaglio (dashed box) connected to a connector element (hexagon with three dots). This connector is linked to a large dashed box labeled m730:Conguaglio_Type. Inside this box are several child elements: m730:NumeroRate, m730:ImportoTrattenutoSaldo, m730:ImportoTrattenutoAcconto, m730:ImportoDaVersareF24Saldo, m730:ImportoDaVersareF24Acc..., m730:ImportoRimborsato, m730:ImportoRimborsatoAgenzia, and m730:OpzioneInformativa.</p>
namespace	urn:www.agenziaentrate.gov.it:specificheTecniche:sco:730
type	m730:Conguaglio_Type
children	m730:NumeroRate m730:ImportoTrattenutoSaldo m730:ImportoTrattenutoAcconto m730:ImportoDaVersareF24Saldo m730:ImportoDaVersareF24Acconto m730:ImportoRimborsato m730:ImportoRimborsatoAgenzia m730:OpzioneInformativa

element **Documento_730_Type/EsitiContabili/Mod730Integrativo**

diagram	
namespace	urn:www.agenziaentrato.gov.it:specificheTecniche:sco:730
type	m730:Mod730_Integrativo_Type
children	m730:ImportiRimborsare m730:ImportoRimborsato m730:ImportoRimborsatoAgenzia

element **Documento_730_Type/EsitiContabili/VersamentiF24**

<p>diagram</p>	
<p>namespace</p>	<p>urn:www.agenziaentrate.gov.it:specificheTecniche:sco:730</p>
<p>type</p>	<p>m730:Versamenti_F24_Type</p>
<p>children</p>	<p>m730:F24DebitoIrpef m730:F24DebitoCodRegione m730:F24DebitoAddReg m730:F24DebitoCodComune m730:F24DebitoAddCom m730:F24DebitoPrimaRataAcclrpef m730:F24DebitoAccontoTassSep</p>

	m730:F24DebitoCodComuneAcconto m730:F24DebitoAccontoAddCom m730:F24DebitoImpostaSost m730:F24DebitoCedolare m730:F24DebitoPrimaRataAccCedolare m730:F24DebitoContribSolidarieta m730:F24DebitoCodRegioneConiuge m730:F24DebitoAddRegConiuge m730:F24DebitoCodComuneConiuge m730:F24DebitoAddComConiuge m730:F24DebitoCodComuneAccontoConiuge m730:F24DebitoAccontoAddComConiuge m730:F24DebitoSecondaRataAcclrpef m730:F24DebitoSecondaRataAccCedolare
--	---

element Documento_730_Type/DatiRettificati

diagram	
namespace	urn:www.agenziaentrate.gov.it:specificheTecniche:sco:730
type	m730:Dati_Rettificati_Type
children	m730:Rettifica

complexType Domanda_Accatamento_Type

diagram	
namespace	urn:www.agenziaentrate.gov.it:specificheTecniche:sco:730
children	m730:Data m730:Numero m730:ProvinciaUfficio

element Domanda_Accatamento_Type/Data

diagram					
namespace	urn:www.agenziaentrate.gov.it:specificheTecniche:sco:730				
type	DatoDT_Type				
facets	<table border="1"> <thead> <tr> <th>Kind</th> <th>Value</th> </tr> </thead> <tbody> <tr> <td>pattern</td> <td>(((0[1-9][12][0-9]3[01])(0[13578][10]12)\d{4})) (((0[1-9][12][0-9]30)(0[469][11]\d{4})) ((0[1-9][1[0-9]]2[0-8])(02)\d{4})) ((29)(02)([02468][048]00)) ((29)(02)([13579][26]00)) ((29)(02)([0-9][0][48])) ((29)(02)([0-9][2468][048])) ((29)(02)([0-9][13579][26]))</td> </tr> </tbody> </table>	Kind	Value	pattern	(((0[1-9][12][0-9]3[01])(0[13578][10]12)\d{4})) (((0[1-9][12][0-9]30)(0[469][11]\d{4})) ((0[1-9][1[0-9]]2[0-8])(02)\d{4})) ((29)(02)([02468][048]00)) ((29)(02)([13579][26]00)) ((29)(02)([0-9][0][48])) ((29)(02)([0-9][2468][048])) ((29)(02)([0-9][13579][26]))
Kind	Value				
pattern	(((0[1-9][12][0-9]3[01])(0[13578][10]12)\d{4})) (((0[1-9][12][0-9]30)(0[469][11]\d{4})) ((0[1-9][1[0-9]]2[0-8])(02)\d{4})) ((29)(02)([02468][048]00)) ((29)(02)([13579][26]00)) ((29)(02)([0-9][0][48])) ((29)(02)([0-9][2468][048])) ((29)(02)([0-9][13579][26]))				

element Domanda_Accatamento_Type/Numero

diagram	
namespace	urn:www.agenziaentrate.gov.it:specificheTecniche:sco:730

type	DatoAN_Type
facets	Kind Value pattern ([0-9A-Z\-\] \"){1}([0-9A-Z&] '\- \., /'°\^\(\)\ À É È Ì Ò Ù Û \" \ \ \/\+)*

element **Domanda_Accatamento_Type/ProvinciaUfficio**

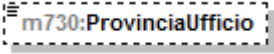
diagram	
namespace	urn:www.agenziaentrate.gov.it:specificheTecniche:sco:730
type	PN_Type

complexType **Domicilio_Fiscale_Aconto_Type**

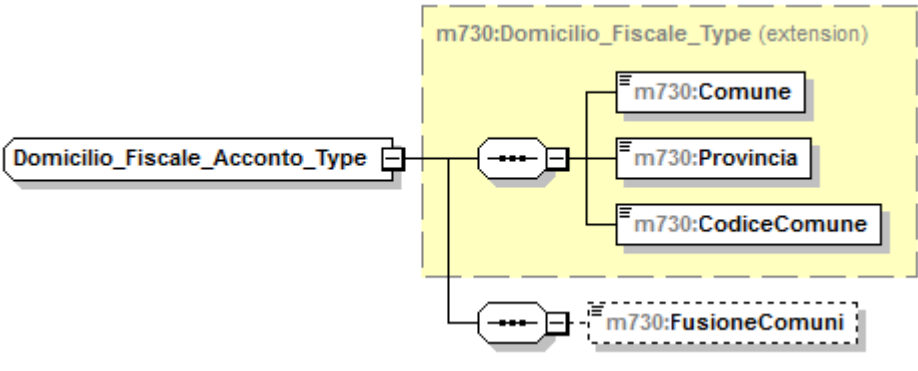
diagram	
namespace	urn:www.agenziaentrate.gov.it:specificheTecniche:sco:730
type	extension of m730:Domicilio_Fiscale_Type
children	m730:Comune m730:Provincia m730:CodiceComune m730:FusioneComuni

element **Domicilio_Fiscale_Aconto_Type/FusioneComuni**

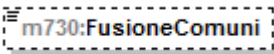
diagram	
namespace	urn:www.agenziaentrate.gov.it:specificheTecniche:sco:730
type	DatoAN_Type
facets	Kind Value pattern ([0-9A-Z\-\] \"){1}([0-9A-Z&] '\- \., /'°\^\(\)\ À É È Ì Ò Ù Û \" \ \ \/\+)*

complexType **Domicilio_Fiscale_Type**

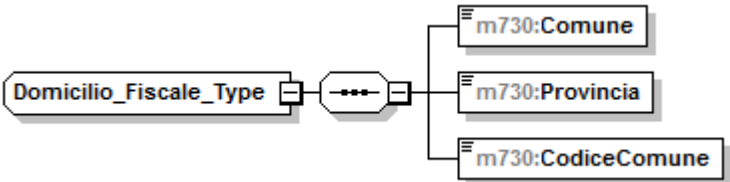
diagram	
---------	--

complexType **Domicilio_Sogg_Ass_Fiscale_Type**

diagram	
namespace	urn:www.agenziaentrate.gov.it:specificheTecniche:sco:730
children	m730:Comune m730:Provincia m730:CodiceComune m730:Cap m730:Indirizzo m730:Telefono m730:FAX m730:Email

element **Domicilio_Sogg_Ass_Fiscale_Type/Comune**

diagram					
namespace	urn:www.agenziaentrate.gov.it:specificheTecniche:sco:730				
type	DatoAN_Type				
facets	<table border="0"> <tr> <td>Kind</td> <td>Value</td> </tr> <tr> <td>pattern</td> <td>(([0-9A-Z\-\]]&quot;){1}([0-9A-Z&amp;:] ' \- \., / ° '^\(\\) À È É Ì Ò Ù Û &quot; \\ / +)*</td> </tr> </table>	Kind	Value	pattern	(([0-9A-Z\-\]]"){1}([0-9A-Z&:] ' \- \., / ° '^\(\\) À È É Ì Ò Ù Û " \\ / +)*
Kind	Value				
pattern	(([0-9A-Z\-\]]"){1}([0-9A-Z&:] ' \- \., / ° '^\(\\) À È É Ì Ò Ù Û " \\ / +)*				

element **Domicilio_Sogg_Ass_Fiscale_Type/Provincia**

diagram	
namespace	urn:www.agenziaentrate.gov.it:specificheTecniche:sco:730
type	PR_Type

element **Domicilio_Sogg_Ass_Fiscale_Type/CodiceComune**

diagram					
namespace	urn:www.agenziaentrate.gov.it:specificheTecniche:sco:730				
type	DatoAN_Type				
facets	<table border="0"> <tr> <td>Kind</td> <td>Value</td> </tr> <tr> <td>pattern</td> <td>(([0-9A-Z\-\]]&quot;){1}([0-9A-Z&amp;:] ' \- \., / ° '^\(\\) À È É Ì Ò Ù Û &quot; \\ / +)*</td> </tr> </table>	Kind	Value	pattern	(([0-9A-Z\-\]]"){1}([0-9A-Z&:] ' \- \., / ° '^\(\\) À È É Ì Ò Ù Û " \\ / +)*
Kind	Value				
pattern	(([0-9A-Z\-\]]"){1}([0-9A-Z&:] ' \- \., / ° '^\(\\) À È É Ì Ò Ù Û " \\ / +)*				

element Domicilio_Sogg_Ass_Fiscale_Type/Cap

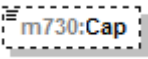
diagram	
namespace	urn:www.agenziaentrate.gov.it:specificheTecniche:sco:730
type	DatoAN_Type
facets	Kind Value pattern ([0-9A-Z-]*)"}{1}([0-9A-Z&:] ' \"- \\. , / ^ \\^\\(\\)À È É Ì Ò Ù Û "; \\ \\ \\+)*

element Domicilio_Sogg_Ass_Fiscale_Type/Indirizzo

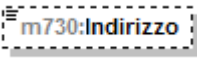
diagram	
namespace	urn:www.agenziaentrate.gov.it:specificheTecniche:sco:730
type	DatoAN_Type
facets	Kind Value pattern ([0-9A-Z-]*)"}{1}([0-9A-Z&:] ' \"- \\. , / ^ \\^\\(\\)À È É Ì Ò Ù Û "; \\ \\ \\+)*

element Domicilio_Sogg_Ass_Fiscale_Type/Telefono

diagram	
namespace	urn:www.agenziaentrate.gov.it:specificheTecniche:sco:730
type	DatoAN_Type
facets	Kind Value pattern ([0-9A-Z-]*)"}{1}([0-9A-Z&:] ' \"- \\. , / ^ \\^\\(\\)À È É Ì Ò Ù Û "; \\ \\ \\+)*

element Domicilio_Sogg_Ass_Fiscale_Type/FAX

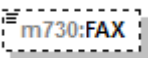
diagram	
namespace	urn:www.agenziaentrate.gov.it:specificheTecniche:sco:730
type	DatoAN_Type
facets	Kind Value pattern ([0-9A-Z-]*)"}{1}([0-9A-Z&:] ' \"- \\. , / ^ \\^\\(\\)À È É Ì Ò Ù Û "; \\ \\ \\+)*

element Domicilio_Sogg_Ass_Fiscale_Type/Email

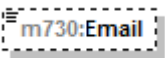
diagram	
namespace	urn:www.agenziaentrate.gov.it:specificheTecniche:sco:730
type	DatoEM_Type

facets	Kind	Value
	pattern	[a-zA-Z0-9._%'\-\"?^~=]+\@[a-zA-Z0-9.\-]+\.[a-zA-Z]{2,4}

complexType **Eccedenze_Oltre_Anno_Type**

diagram	
namespace	urn:www.agenziaentrate.gov.it:specificheTecniche:sco:730
children	m730:Anno m730:Irpef m730:SostitutivaQuadroRT m730:CedolareSecca m730:CodiceRegione m730:AddRegionaleIrpef m730:CodiceCatastaleComune m730:AddComunaleIrpef m730:ImpostaSostitutiva

element **Eccedenze_Oltre_Anno_Type/Anno**

diagram	
namespace	urn:www.agenziaentrate.gov.it:specificheTecniche:sco:730
type	DatoDA_Type
facets	Kind Value pattern (18 19 20)[0-9]{2}

element **Eccedenze_Oltre_Anno_Type/Irpef**

diagram	
namespace	urn:www.agenziaentrate.gov.it:specificheTecniche:sco:730
type	DatoNP_Type
facets	Kind Value pattern [1-9]{1}[0-9]*

element **Eccedenze_Oltre_Anno_Type/SostitutivaQuadroRT**

diagram					
namespace	urn:www.agenziaentrate.gov.it:specificheTecniche:sco:730				
type	DatoNP_Type				
facets	<table border="1"> <thead> <tr> <th>Kind</th> <th>Value</th> </tr> </thead> <tbody> <tr> <td>pattern</td> <td>[1-9]{1}[0-9]*</td> </tr> </tbody> </table>	Kind	Value	pattern	[1-9]{1}[0-9]*
Kind	Value				
pattern	[1-9]{1}[0-9]*				

element **Eccedenze_Oltre_Anno_Type/CedolareSecca**

diagram					
namespace	urn:www.agenziaentrate.gov.it:specificheTecniche:sco:730				
type	DatoNP_Type				
facets	<table border="1"> <thead> <tr> <th>Kind</th> <th>Value</th> </tr> </thead> <tbody> <tr> <td>pattern</td> <td>[1-9]{1}[0-9]*</td> </tr> </tbody> </table>	Kind	Value	pattern	[1-9]{1}[0-9]*
Kind	Value				
pattern	[1-9]{1}[0-9]*				

element **Eccedenze_Oltre_Anno_Type/CodiceRegione**

diagram																																															
namespace	urn:www.agenziaentrate.gov.it:specificheTecniche:sco:730																																														
type	Codice_Regione_Type																																														
facets	<table border="1"> <thead> <tr> <th>Kind</th> <th>Value</th> </tr> </thead> <tbody> <tr> <td>pattern</td> <td>(([0-9A-Z\-_]\&quot;){1}([0-9A-Z&amp;:] \- \., / \° \^ \(\) \À \É \ \Ò \Ù \Ü \&quot; \N \+)*</td> </tr> <tr> <td>enumeration</td> <td>1</td> </tr> <tr> <td>enumeration</td> <td>2</td> </tr> <tr> <td>enumeration</td> <td>3</td> </tr> <tr> <td>enumeration</td> <td>4</td> </tr> <tr> <td>enumeration</td> <td>5</td> </tr> <tr> <td>enumeration</td> <td>6</td> </tr> <tr> <td>enumeration</td> <td>7</td> </tr> <tr> <td>enumeration</td> <td>8</td> </tr> <tr> <td>enumeration</td> <td>9</td> </tr> <tr> <td>enumeration</td> <td>10</td> </tr> <tr> <td>enumeration</td> <td>11</td> </tr> <tr> <td>enumeration</td> <td>12</td> </tr> <tr> <td>enumeration</td> <td>13</td> </tr> <tr> <td>enumeration</td> <td>14</td> </tr> <tr> <td>enumeration</td> <td>15</td> </tr> <tr> <td>enumeration</td> <td>16</td> </tr> <tr> <td>enumeration</td> <td>17</td> </tr> <tr> <td>enumeration</td> <td>18</td> </tr> <tr> <td>enumeration</td> <td>19</td> </tr> <tr> <td>enumeration</td> <td>20</td> </tr> <tr> <td>enumeration</td> <td>21</td> </tr> </tbody> </table>	Kind	Value	pattern	(([0-9A-Z\-_]\"){1}([0-9A-Z&:] \- \., / \° \^ \(\) \À \É \ \Ò \Ù \Ü \" \N \+)*	enumeration	1	enumeration	2	enumeration	3	enumeration	4	enumeration	5	enumeration	6	enumeration	7	enumeration	8	enumeration	9	enumeration	10	enumeration	11	enumeration	12	enumeration	13	enumeration	14	enumeration	15	enumeration	16	enumeration	17	enumeration	18	enumeration	19	enumeration	20	enumeration	21
Kind	Value																																														
pattern	(([0-9A-Z\-_]\"){1}([0-9A-Z&:] \- \., / \° \^ \(\) \À \É \ \Ò \Ù \Ü \" \N \+)*																																														
enumeration	1																																														
enumeration	2																																														
enumeration	3																																														
enumeration	4																																														
enumeration	5																																														
enumeration	6																																														
enumeration	7																																														
enumeration	8																																														
enumeration	9																																														
enumeration	10																																														
enumeration	11																																														
enumeration	12																																														
enumeration	13																																														
enumeration	14																																														
enumeration	15																																														
enumeration	16																																														
enumeration	17																																														
enumeration	18																																														
enumeration	19																																														
enumeration	20																																														
enumeration	21																																														

element **Eccedenze_Oltre_Anno_Type/AddRegionalelrpef**

diagram	
---------	--

namespace	urn:www.agenziaentrate.gov.it:specificheTecniche:sco:730
type	DatoNP_Type
facets	Kind Value pattern [1-9]{1}[0-9]*

element **Eccedenze_Oltre_Anno_Type/CodiceCatastaleComune**

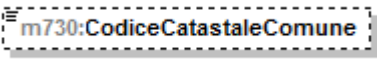
diagram	
namespace	urn:www.agenziaentrate.gov.it:specificheTecniche:sco:730
type	restriction of DatoAN_Type
facets	Kind Value pattern ([0-9A-Z-] \"){1}([0-9A-Z&:] \- \., / \^\(\ \) À È É Ì Ò Ù Û " \ \ /+)*

element **Eccedenze_Oltre_Anno_Type/AddComunalelrpef**

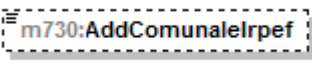
diagram	
namespace	urn:www.agenziaentrate.gov.it:specificheTecniche:sco:730
type	DatoNP_Type
facets	Kind Value pattern [1-9]{1}[0-9]*

element **Eccedenze_Oltre_Anno_Type/ImpostaSostitutiva**

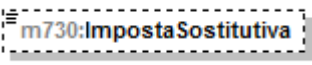
diagram	
namespace	urn:www.agenziaentrate.gov.it:specificheTecniche:sco:730
type	DatoNP_Type
facets	Kind Value pattern [1-9]{1}[0-9]*

complexType **Eccedenze_Type**

diagram	
namespace	urn:www.agenziaentrate.gov.it:specificheTecniche:sco:730
children	m730:Irpef m730:IrpefCompF24 m730:SostitutivaQuadroRT m730:SostitutivaQuadroRTcompF24 m730:CedolareSecca m730:CedolareSeccaCompF24 m730:CodiceRegione m730:AddRegionaleIrpef m730:AddRegionaleIrpefCompF24 m730:CodiceCatastaleComune m730:AddComunaleIrpef m730:AddComunaleIrpefF24

element **Eccedenze_Type/Irpef**

diagram					
namespace	urn:www.agenziaentrate.gov.it:specificheTecniche:sco:730				
type	DatoNP_Type				
facets	<table border="1"> <thead> <tr> <th>Kind</th> <th>Value</th> </tr> </thead> <tbody> <tr> <td>pattern</td> <td>[1-9]{1}[0-9]*</td> </tr> </tbody> </table>	Kind	Value	pattern	[1-9]{1}[0-9]*
Kind	Value				
pattern	[1-9]{1}[0-9]*				

element **Eccedenze_Type/IrpefCompF24**

diagram					
namespace	urn:www.agenziaentrate.gov.it:specificheTecniche:sco:730				
type	DatoNP_Type				
facets	<table border="1"> <thead> <tr> <th>Kind</th> <th>Value</th> </tr> </thead> <tbody> <tr> <td></td> <td></td> </tr> </tbody> </table>	Kind	Value		
Kind	Value				

	pattern [1-9]{1}[0-9]*
--	------------------------

element **Eccedenze_Type/SostitutivaQuadroRT**

diagram	 m730:SostitutivaQuadroRT
namespace	urn:www.agenziaentrate.gov.it:specificheTecniche:sco:730
type	DatoNP_Type
facets	Kind Value pattern [1-9]{1}[0-9]*

element **Eccedenze_Type/SostitutivaQuadroRTcompF24**

diagram	 m730:SostitutivaQuadroRTcomp...
namespace	urn:www.agenziaentrate.gov.it:specificheTecniche:sco:730
type	DatoNP_Type
facets	Kind Value pattern [1-9]{1}[0-9]*

element **Eccedenze_Type/CedolareSecca**

diagram	 m730:Cedolare Secca
namespace	urn:www.agenziaentrate.gov.it:specificheTecniche:sco:730
type	DatoNP_Type
facets	Kind Value pattern [1-9]{1}[0-9]*

element **Eccedenze_Type/CedolareSeccaCompF24**

diagram	 m730:Cedolare SeccaCompF24
namespace	urn:www.agenziaentrate.gov.it:specificheTecniche:sco:730
type	DatoNP_Type
facets	Kind Value pattern [1-9]{1}[0-9]*

element **Eccedenze_Type/CodiceRegione**

diagram	 m730:CodiceRegione
namespace	urn:www.agenziaentrate.gov.it:specificheTecniche:sco:730
type	Codice_Regione_Type

facets	Kind	Value
	pattern	([0-9A-Z\-\]]"){1}([0-9A-Z&#92;]\- \., / \°\^\(\ \)\À È É ì Ò Ù Ü " \ \\ \ +)*
	enumeration	1
	enumeration	2
	enumeration	3
	enumeration	4
	enumeration	5
	enumeration	6
	enumeration	7
	enumeration	8
	enumeration	9
	enumeration	10
	enumeration	11
	enumeration	12
	enumeration	13
	enumeration	14
	enumeration	15
	enumeration	16
	enumeration	17
	enumeration	18
	enumeration	19
enumeration	20	
enumeration	21	

element **Eccedenze_Type/AddRegionalelrpef**

diagram					
namespace	urn:www.agenziaentrate.gov.it:specificheTecniche:sco:730				
type	DatoNP_Type				
facets	<table border="1"> <tr> <td>Kind</td> <td>Value</td> </tr> <tr> <td>pattern</td> <td>[1-9]{1}[0-9]*</td> </tr> </table>	Kind	Value	pattern	[1-9]{1}[0-9]*
Kind	Value				
pattern	[1-9]{1}[0-9]*				

element **Eccedenze_Type/AddRegionalelrpefCompF24**

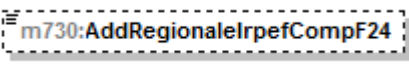
diagram					
namespace	urn:www.agenziaentrate.gov.it:specificheTecniche:sco:730				
type	DatoNP_Type				
facets	<table border="1"> <tr> <td>Kind</td> <td>Value</td> </tr> <tr> <td>pattern</td> <td>[1-9]{1}[0-9]*</td> </tr> </table>	Kind	Value	pattern	[1-9]{1}[0-9]*
Kind	Value				
pattern	[1-9]{1}[0-9]*				

element **Eccedenze_Type/CodiceCatastaleComune**

diagram					
namespace	urn:www.agenziaentrate.gov.it:specificheTecniche:sco:730				
type	restriction of DatoAN_Type				
facets	<table border="1"> <tr> <td>Kind</td> <td>Value</td> </tr> <tr> <td>pattern</td> <td>([0-9A-Z\-\]]&quot;){1}([0-9A-Z&amp;#92;]\- \., / \°\^\(\ \)\À È É ì Ò Ù Ü &quot; \ \\ \ +)*</td> </tr> </table>	Kind	Value	pattern	([0-9A-Z\-\]]"){1}([0-9A-Z&#92;]\- \., / \°\^\(\ \)\À È É ì Ò Ù Ü " \ \\ \ +)*
Kind	Value				
pattern	([0-9A-Z\-\]]"){1}([0-9A-Z&#92;]\- \., / \°\^\(\ \)\À È É ì Ò Ù Ü " \ \\ \ +)*				

element **Eccedenze_Type/AddComunalelrpef**

diagram	
namespace	urn:www.agenziaentrato.gov.it:specificheTecnico:sco:730
type	DatoNP_Type
facets	Kind Value pattern [1-9]{1}[0-9]*

element **Eccedenze_Type/AddComunalelrpefF24**

diagram	
namespace	urn:www.agenziaentrato.gov.it:specificheTecnico:sco:730
type	DatoNP_Type
facets	Kind Value pattern [1-9]{1}[0-9]*

complexType **Elemento_Integrativo_Type**

diagram	
namespace	urn:www.agenziaentrato.gov.it:specificheTecnico:sco:730
children	m730:lrpef m730:AddizionaleRegionalelrpef m730:AddComunalelrpef m730:CedolareSecca

element **Elemento_Integrativo_Type/lrpef**

diagram	
namespace	urn:www.agenziaentrato.gov.it:specificheTecnico:sco:730
type	DatoNP_Type
facets	Kind Value pattern [1-9]{1}[0-9]*

element **Elemento_Integrativo_Type/AddizionaleRegionalelrpef**

diagram	
namespace	urn:www.agenziaentrato.gov.it:specificheTecnico:sco:730

type	DatoNP_Type
facets	Kind Value pattern [1-9]{1}[0-9]*

element **Elemento_Integrativo_Type/AddComunaleIrpef**

diagram	
namespace	urn:www.agenziaentrate.gov.it:specificheTecniche:sco:730
type	DatoNP_Type
facets	Kind Value pattern [1-9]{1}[0-9]*

element **Elemento_Integrativo_Type/CedolareSecca**

diagram	
namespace	urn:www.agenziaentrate.gov.it:specificheTecniche:sco:730
type	DatoNP_Type
facets	Kind Value pattern [1-9]{1}[0-9]*

complexType **Esenzione_Add_Comunale_Type**

diagram	
namespace	urn:www.agenziaentrate.gov.it:specificheTecniche:sco:730
children	m730:SogliaEsenzioneSaldo m730:SogliaEsenzioneAcconto

element **Esenzione_Add_Comunale_Type/SogliaEsenzioneSaldo**

diagram	
namespace	urn:www.agenziaentrate.gov.it:specificheTecniche:sco:730
type	m730:Soglie_Esenzione_Type
children	m730:SogliaEsenzione m730:EsenzioneTotale

element **Esenzione_Add_Comunale_Type/SogliaEsenzioneAcconto**

diagram	
namespace	urn:www.agenziaentrate.gov.it:specificheTecniche:sco:730
type	m730:Soglie_Esenzione_Type
children	m730:SogliaEsenzione m730:EsenzioneTotale

complexType **Esenzione_Bonus_Type**

diagram	
namespace	urn:www.agenziaentrate.gov.it:specificheTecniche:sco:730
children	m730:TipologiaEsenzione m730:ParteRedditoEsente

element **Esenzione_Bonus_Type/TipologiaEsenzione**

diagram									
namespace	urn:www.agenziaentrate.gov.it:specificheTecniche:sco:730								
type	restriction of DatoN1_Type								
facets	<table border="1"> <thead> <tr> <th>Kind</th> <th>Value</th> </tr> </thead> <tbody> <tr> <td>pattern</td> <td>[1-9]</td> </tr> <tr> <td>enumeration</td> <td>1</td> </tr> <tr> <td>enumeration</td> <td>2</td> </tr> </tbody> </table>	Kind	Value	pattern	[1-9]	enumeration	1	enumeration	2
Kind	Value								
pattern	[1-9]								
enumeration	1								
enumeration	2								

element **Esenzione_Bonus_Type/ParteRedditoEsente**

diagram					
namespace	urn:www.agenziaentrate.gov.it:specificheTecniche:sco:730				
type	DatoNP_Type				
facets	<table border="1"> <thead> <tr> <th>Kind</th> <th>Value</th> </tr> </thead> <tbody> <tr> <td>pattern</td> <td>[1-9]{1}[0-9]*</td> </tr> </tbody> </table>	Kind	Value	pattern	[1-9]{1}[0-9]*
Kind	Value				
pattern	[1-9]{1}[0-9]*				

complexType Esito_Liquidazione_Type

diagram	
namespace	urn:www.agenziaentrate.gov.it:specificheTecniche:sco:730
children	m730:Credito m730:Debito

element Esito_Liquidazione_Type/Credito

diagram	
namespace	urn:www.agenziaentrate.gov.it:specificheTecniche:sco:730
type	m730:Credito_Type
children	m730:NonRimborsabile m730:Credito m730:CreditoF24 m730:CreditoRimborso

element Esito_Liquidazione_Type/Debito

diagram	
namespace	urn:www.agenziaentrate.gov.it:specificheTecniche:sco:730
type	m730:Debito_Type
children	m730:NonVersare m730:ImportoDaTrattenere

complexType **Fabbricato_Agev_Type**

diagram	
namespace	urn:www.agenziaentrate.gov.it:specificheTecniche:sco:730
children	m730:NumeroRigoRiferimento m730:NumModuloRiferimento m730:DatiContratto m730:CasellaInf30Giorni m730:AnnoDichiarazioneIcilmu m730:StatoEmergenza

element **Fabbricato_Agev_Type/NumeroRigoRiferimento**

diagram																									
namespace	urn:www.agenziaentrate.gov.it:specificheTecniche:sco:730																								
type	m730:Fabbricato_Agev_Numero_Rigo_Type																								
facets	<table border="0"> <thead> <tr> <th>Kind</th> <th>Value</th> </tr> </thead> <tbody> <tr> <td>pattern</td> <td>[1-9]{1}[0-9]*</td> </tr> <tr> <td>enumeration</td> <td>1</td> </tr> <tr> <td>enumeration</td> <td>2</td> </tr> <tr> <td>enumeration</td> <td>3</td> </tr> <tr> <td>enumeration</td> <td>4</td> </tr> <tr> <td>enumeration</td> <td>5</td> </tr> <tr> <td>enumeration</td> <td>6</td> </tr> <tr> <td>enumeration</td> <td>7</td> </tr> <tr> <td>enumeration</td> <td>8</td> </tr> <tr> <td>enumeration</td> <td>9</td> </tr> <tr> <td>enumeration</td> <td>10</td> </tr> </tbody> </table>	Kind	Value	pattern	[1-9]{1}[0-9]*	enumeration	1	enumeration	2	enumeration	3	enumeration	4	enumeration	5	enumeration	6	enumeration	7	enumeration	8	enumeration	9	enumeration	10
Kind	Value																								
pattern	[1-9]{1}[0-9]*																								
enumeration	1																								
enumeration	2																								
enumeration	3																								
enumeration	4																								
enumeration	5																								
enumeration	6																								
enumeration	7																								
enumeration	8																								
enumeration	9																								
enumeration	10																								

element **Fabbricato_Agev_Type/NumModuloRiferimento**

diagram					
namespace	urn:www.agenziaentrate.gov.it:specificheTecniche:sco:730				
type	DatoNP_Type				
facets	<table border="0"> <thead> <tr> <th>Kind</th> <th>Value</th> </tr> </thead> <tbody> <tr> <td>pattern</td> <td>[1-9]{1}[0-9]*</td> </tr> </tbody> </table>	Kind	Value	pattern	[1-9]{1}[0-9]*
Kind	Value				
pattern	[1-9]{1}[0-9]*				

element **Fabbricato_Agev_Type/DatiContratto**

diagram	
namespace	urn:www.agenziaentrate.gov.it:specificheTecniche:sco:730
type	m730:Dati_Contratto_Type
children	m730:DataRegContratto m730:SerieContratto m730:NumeroContratto m730:Sottonumero m730:CodiceUfficio m730:IdentificativoContratto

element **Fabbricato_Agev_Type/CasellaInf30Giorni**

diagram					
namespace	urn:www.agenziaentrate.gov.it:specificheTecniche:sco:730				
type	DatoCB_Type				
facets	<table border="1"> <thead> <tr> <th>Kind</th> <th>Value</th> </tr> </thead> <tbody> <tr> <td>pattern</td> <td>[01]</td> </tr> </tbody> </table>	Kind	Value	pattern	[01]
Kind	Value				
pattern	[01]				

element **Fabbricato_Agev_Type/AnnoDichiarazioneIcilmu**

diagram					
namespace	urn:www.agenziaentrate.gov.it:specificheTecniche:sco:730				
type	DatoDA_Type				
facets	<table border="1"> <thead> <tr> <th>Kind</th> <th>Value</th> </tr> </thead> <tbody> <tr> <td>pattern</td> <td>(18 19 20)[0-9]{2}</td> </tr> </tbody> </table>	Kind	Value	pattern	(18 19 20)[0-9]{2}
Kind	Value				
pattern	(18 19 20)[0-9]{2}				

element **Fabbricato_Agev_Type/StatoEmergenza**

diagram	
namespace	urn:www.agenziaentrate.gov.it:specificheTecniche:sco:730
type	DatoCB_Type

facets	Kind pattern	Value [01]
--------	-----------------	---------------

complexType **Fabbricato_Ord_Type**

diagram	
namespace	urn:www.agenziaentrate.gov.it:specificheTecniche:sco:730
children	m730:Rendita m730:Utilizzo m730:GiorniPossesso m730:PercPossesso m730:CodiceCanone m730:CanoneLocazione m730:CasiParticolari m730:CasellaContinuazione m730:CodiceComune m730:OpzioneCedolare m730:CasellaCasiPartimu

element **Fabbricato_Ord_Type/Rendita**

diagram		
namespace	urn:www.agenziaentrate.gov.it:specificheTecniche:sco:730	
type	DatoNP_Type	
facets	Kind pattern	Value [1-9]{1}[0-9]*

element **Fabbricato_Ord_Type/Utilizzo**

diagram	
namespace	urn:www.agenziaentrate.gov.it:specificheTecniche:sco:730
type	restriction of m730:Utilizzo_Fabbricato_Type

facets	Kind	Value
	pattern	[1-9]{1}[0-9]*
	enumeration	1
	enumeration	2
	enumeration	3
	enumeration	4
	enumeration	5
	enumeration	8
	enumeration	9
	enumeration	10
	enumeration	11
	enumeration	12
	enumeration	14
	enumeration	15
enumeration	16	
enumeration	17	

element **Fabbricato_Ord_Type/GiorniPossesso**

diagram					
namespace	urn:www.agenziaentrate.gov.it:specificheTecniche:sco:730				
type	restriction of DatoNP_Type				
facets	<table border="1"> <tr> <td>Kind</td> <td>Value</td> </tr> <tr> <td>pattern</td> <td>[1-9]{1}[0-9]*</td> </tr> </table>	Kind	Value	pattern	[1-9]{1}[0-9]*
Kind	Value				
pattern	[1-9]{1}[0-9]*				

element **Fabbricato_Ord_Type/PercPossesso**

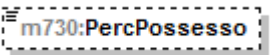
diagram					
namespace	urn:www.agenziaentrate.gov.it:specificheTecniche:sco:730				
type	DatoPC_Type				
facets	<table border="1"> <tr> <td>Kind</td> <td>Value</td> </tr> <tr> <td>pattern</td> <td>[0-9]?[0-9](,\d{1,3})? 100(,0{1,3})?</td> </tr> </table>	Kind	Value	pattern	[0-9]?[0-9](,\d{1,3})? 100(,0{1,3})?
Kind	Value				
pattern	[0-9]?[0-9](,\d{1,3})? 100(,0{1,3})?				

element **Fabbricato_Ord_Type/CodiceCanone**

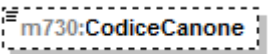
diagram													
namespace	urn:www.agenziaentrate.gov.it:specificheTecniche:sco:730												
type	m730:Codice Canone_Type												
facets	<table border="1"> <tr> <td>Kind</td> <td>Value</td> </tr> <tr> <td>pattern</td> <td>[1-9]</td> </tr> <tr> <td>enumeration</td> <td>1</td> </tr> <tr> <td>enumeration</td> <td>2</td> </tr> <tr> <td>enumeration</td> <td>3</td> </tr> <tr> <td>enumeration</td> <td>4</td> </tr> </table>	Kind	Value	pattern	[1-9]	enumeration	1	enumeration	2	enumeration	3	enumeration	4
Kind	Value												
pattern	[1-9]												
enumeration	1												
enumeration	2												
enumeration	3												
enumeration	4												

element Fabbricato_Ord_Type/CanoneLocazione

diagram	
namespace	urn:www.agenziaentrate.gov.it:specificheTecniche:sco:730
type	DatoNP_Type
facets	Kind Value pattern [1-9]{1}[0-9]*

element Fabbricato_Ord_Type/CasiParticolari

diagram	
namespace	urn:www.agenziaentrate.gov.it:specificheTecniche:sco:730
type	m730:Casi_Particolari_Fabbricato_Type
facets	Kind Value pattern [1-9] enumeration 1 enumeration 3 enumeration 4 enumeration 5

element Fabbricato_Ord_Type/CasellaContinuazione

diagram	
namespace	urn:www.agenziaentrate.gov.it:specificheTecniche:sco:730
type	DatoCB_Type
facets	Kind Value pattern [01]

element Fabbricato_Ord_Type/CodiceComune

diagram	
namespace	urn:www.agenziaentrate.gov.it:specificheTecniche:sco:730
type	restriction of DatoAN_Type
facets	Kind Value pattern (([0-9A-Z\-\]]"){1}([0-9A-Z&:] " \- \., / "^\(\ \) À È É Ì Ò Ù Û " \ \\ / +)*

element Fabbricato_Ord_Type/OpzioneCedolare

diagram	
namespace	urn:www.agenziaentrate.gov.it:specificheTecniche:sco:730
type	DatoCB_Type

facets	Kind	Value
	pattern	[01]

element **Fabbricato_Ord_Type/CasellaCasiPartImu**

diagram											
namespace	urn:www.agenziaentrate.gov.it:specificheTecniche:sco:730										
type	restriction of DatoN1_Type										
facets	<table border="1"> <tr> <td>Kind</td> <td>Value</td> </tr> <tr> <td>pattern</td> <td>[1-9]</td> </tr> <tr> <td>enumeration</td> <td>1</td> </tr> <tr> <td>enumeration</td> <td>2</td> </tr> <tr> <td>enumeration</td> <td>3</td> </tr> </table>	Kind	Value	pattern	[1-9]	enumeration	1	enumeration	2	enumeration	3
Kind	Value										
pattern	[1-9]										
enumeration	1										
enumeration	2										
enumeration	3										

complexType **Familiari_Type**

diagram	
namespace	urn:www.agenziaentrate.gov.it:specificheTecniche:sco:730
children	m730:PrimoModulo m730:Modulo

element **Familiari_Type/PrimoModulo**

diagram	
namespace	urn:www.agenziaentrate.gov.it:specificheTecniche:sco:730
type	m730:Primo_Modulo_Familiari_Type
children	m730:Coniuge m730:PrimoFiglio m730:Familiari m730:PercUlteriore m730:FigliAffidoPread

element **Familiari_Type/Modulo**

diagram	
namespace	urn:www.agenziaentrate.gov.it:specificheTecniche:sco:730
type	m730:Modulo_Familiari_Type
children	m730:Coniuge m730:PrimoFiglio m730:Familiari

complexType **Firma_Dichiarazione_Type**

diagram	
namespace	urn:www.agenziaentrate.gov.it:specificheTecniche:sco:730
children	m730:NumeroModelli m730:FirmaDichiarazione m730:OpzioneInformativa m730:SoggettoFiscalmenteCarico m730:QuadroK

element **Firma_Dichiarazione_Type/NumeroModelli**

diagram					
namespace	urn:www.agenziaentrate.gov.it:specificheTecniche:sco:730				
type	DatoNP_Type				
facets	<table border="1"> <thead> <tr> <th>Kind</th> <th>Value</th> </tr> </thead> <tbody> <tr> <td>pattern</td> <td>[1-9]{1}[0-9]*</td> </tr> </tbody> </table>	Kind	Value	pattern	[1-9]{1}[0-9]*
Kind	Value				
pattern	[1-9]{1}[0-9]*				

element **Firma_Dichiarazione_Type/FirmaDichiarazione**

diagram	
namespace	urn:www.agenziaentrate.gov.it:specificheTecniche:sco:730

type	DatoCB_Type
facets	Kind Value pattern [01]

element **Firma_Dichiarazione_Type/OpzioneInformativa**

diagram	
namespace	urn:www.agenziaentrate.gov.it:specificheTecniche:sco:730
type	DatoCB_Type
facets	Kind Value pattern [01]

element **Firma_Dichiarazione_Type/SoggettoFiscalmenteCarico**

diagram	
namespace	urn:www.agenziaentrate.gov.it:specificheTecniche:sco:730
type	DatoCB_Type
facets	Kind Value pattern [01]

element **Firma_Dichiarazione_Type/QuadroK**

diagram	
namespace	urn:www.agenziaentrate.gov.it:specificheTecniche:sco:730
type	DatoCB_Type
facets	Kind Value pattern [01]

complexType **Fondo_Pensione_Dipendenti_Pubblici_Type**

diagram	
namespace	urn:www.agenziaentrate.gov.it:specificheTecniche:sco:730
children	m730:Contributi m730:QuotaTFR

element **Fondo_Pensione_Dipendenti_Pubblici_Type/Contributi**

diagram	
namespace	urn:www.agenziaentrate.gov.it:specificheTecniche:sco:730
type	m730:Contributi Previdenza Complementare Type
children	m730:EsclusiDalSostituto m730:NonEsclusiDalSostituto

element **Fondo_Pensione_Dipendenti_Pubblici_Type/QuotaTFR**

diagram					
namespace	urn:www.agenziaentrate.gov.it:specificheTecniche:sco:730				
type	DatoNP Type				
facets	<table border="1"> <tr> <td>Kind</td> <td>Value</td> </tr> <tr> <td>pattern</td> <td>[1-9]{1}[0-9]*</td> </tr> </table>	Kind	Value	pattern	[1-9]{1}[0-9]*
Kind	Value				
pattern	[1-9]{1}[0-9]*				

complexType **Frontespizio_730_Type**

diagram	
namespace	urn:www.agenziaentrate.gov.it:specificheTecniche:sco:730
children	m730:SoggettoFiscale m730:DatiAnagrafici m730:StatoCivile m730:ResidenzaAnagrafica m730:DomicilioFiscaleSaldo m730:DomicilioFiscaleAcconto m730:CasiParticolariAddizionale m730:Firma

element Frontespizio_730_Type/SoggettoFiscale

diagram	
namespace	urn:www.agenziaentrate.gov.it:specificheTecniche:sco:730
type	m730:Soggetto_Fiscale_730_Type
children	m730:CodiceFiscale m730:Email m730:Telefono m730:Cellulare

element Frontespizio_730_Type/DatiAnagrafici

diagram	
namespace	urn:www.agenziaentrate.gov.it:specificheTecniche:sco:730
type	Dati_Anagrafici_Type
children	Cognome Nome Sesso DataNascita ComuneNascita ProvinciaNascita

element Frontespizio_730_Type/StatoCivile

diagram							
namespace	urn:www.agenziaentrate.gov.it:specificheTecniche:sco:730						
type	m730:Stato_Civile_Type						
facets	<table border="0"> <tr> <td>Kind</td> <td>Value</td> </tr> <tr> <td>pattern</td> <td>[1-9]{1}[0-9]*</td> </tr> <tr> <td>enumeration</td> <td>7</td> </tr> </table>	Kind	Value	pattern	[1-9]{1}[0-9]*	enumeration	7
Kind	Value						
pattern	[1-9]{1}[0-9]*						
enumeration	7						

element Frontespizio_730_Type/ResidenzaAnagrafica

<p>diagram</p>	
<p>namespace</p>	<p>urn:www.agenziaentrate.gov.it:specificheTecniche:sco:730</p>
<p>type</p>	<p>m730:Residenza_Anagrafica_730_Type</p>
<p>children</p>	<p>Comune Provincia CodiceComune Indirizzo Cap DataVariazione m730:Tipologia m730:NumCivico m730:Frazione m730:PrimaPresentazione</p>

element Frontespizio_730_Type/DomicilioFiscaleSaldo

<p>diagram</p>	
<p>namespace</p>	<p>urn:www.agenziaentrate.gov.it:specificheTecniche:sco:730</p>
<p>type</p>	<p>m730:Domicilio_Fiscale_Type</p>
<p>children</p>	<p>m730:Comune m730:Provincia m730:CodiceComune</p>

element Frontespizio_730_Type/DomicilioFiscaleAcconto

diagram	
namespace	urn:www.agenziaentrate.gov.it:specificheTecniche:sco:730
type	m730:Domicilio_Fiscale_Acconto_Type
children	m730:Comune m730:Provincia m730:CodiceComune m730:FusioneComuni

element Frontespizio_730_Type/CasiParticolariAddizionale

diagram					
namespace	urn:www.agenziaentrate.gov.it:specificheTecniche:sco:730				
type	DatoCB_Type				
facets	<table border="1"> <thead> <tr> <th>Kind</th> <th>Value</th> </tr> </thead> <tbody> <tr> <td>pattern</td> <td>[01]</td> </tr> </tbody> </table>	Kind	Value	pattern	[01]
Kind	Value				
pattern	[01]				

element Frontespizio_730_Type/Firma

diagram	
namespace	urn:www.agenziaentrate.gov.it:specificheTecniche:sco:730
type	m730:Firma Dichiarazione Type
children	m730:NumeroModelli m730:FirmaDichiarazione m730:OpzioneInformativa m730:SoggettoFiscalmenteCarico m730:QuadroK

complexType Frontespizio_Con_Type

<p>diagram</p>	<p>The diagram illustrates the structure of the <code>Frontespizio_Con_Type</code> complex type. It is an extension of the <code>m730:Frontespizio_730_Type</code>. The <code>Frontespizio_Con_Type</code> is represented by a rounded rectangle with a small square on its right side. A dashed line with a small square on its left side connects it to a larger rounded rectangle representing the base type, <code>m730:Frontespizio_730_Type (extension)</code>. This base type contains several elements, each in a rounded rectangle with a small square on its right side. The elements are: <code>m730:SoggettoFiscale</code>, <code>m730:DatiAnagrafici</code>, <code>m730:StatoCivile</code>, <code>m730:ResidenzaAnagrafica</code>, <code>m730:DomicilioFiscaleSaldo</code>, <code>m730:DomicilioFiscaleAcconto</code>, <code>m730:CasiParticolariAddizionale</code>, and <code>m730:Firma</code>. The elements <code>m730:StatoCivile</code>, <code>m730:ResidenzaAnagrafica</code>, <code>m730:DomicilioFiscaleAcconto</code>, and <code>m730:CasiParticolariAddizionale</code> are shown with dashed borders, indicating they are optional or derived. The other elements have solid borders, indicating they are required.</p>
<p>namespace</p>	<p>urn:www.agenziaentrate.gov.it:specificheTecniche:sco:730</p>
<p>type</p>	<p>extension of m730:Frontespizio_730_Type</p>
<p>children</p>	<p>m730:SoggettoFiscale m730:DatiAnagrafici m730:StatoCivile m730:ResidenzaAnagrafica m730:DomicilioFiscaleSaldo m730:DomicilioFiscaleAcconto m730:CasiParticolariAddizionale m730:Firma</p>

complexType Frontespizio_Dich_Type

diagram	
namespace	urn:www.agenziaentrate.gov.it:specificheTecniche:sco:730
type	extension of m730:Frontespizio_730_Type
children	m730:SoggettoFiscale m730:DatiAnagrafici m730:StatoCivile m730:ResidenzaAnagrafica m730:DomicilioFiscaleSaldo m730:DomicilioFiscaleAcconto m730:CasiParticolariAddizionale m730:Firma m730:Rappresentante

element Frontespizio_Dich_Type/Rappresentante

diagram	
namespace	urn:www.agenziaentrate.gov.it:specificheTecniche:sco:730
type	m730:Rappresentante_Type
children	m730:SoggettoFiscale m730:DatiAnagrafici m730:ResidenzaAnagrafica m730:Firma

complexType **Fuori_Assistenza_Type**

diagram	
namespace	urn:www.agenziaentrate.gov.it:specificheTecniche:sco:730
children	m730:AnomaliaDatianagrafici m730:AnomaliaTerreni m730:AnomaliaFabbricati m730:AnomaliaLavDip m730:AnomaliaAltriRedditi m730:AnomaliaQuadroF

element **Fuori_Assistenza_Type/AnomaliaDatianagrafici**

diagram					
namespace	urn:www.agenziaentrate.gov.it:specificheTecniche:sco:730				
type	DatoCB_Type				
facets	<table border="1"> <tr> <td>Kind</td> <td>Value</td> </tr> <tr> <td>pattern</td> <td>[01]</td> </tr> </table>	Kind	Value	pattern	[01]
Kind	Value				
pattern	[01]				

element **Fuori_Assistenza_Type/AnomaliaTerreni**

diagram					
namespace	urn:www.agenziaentrate.gov.it:specificheTecniche:sco:730				
type	DatoCB_Type				
facets	<table border="1"> <tr> <td>Kind</td> <td>Value</td> </tr> <tr> <td>pattern</td> <td>[01]</td> </tr> </table>	Kind	Value	pattern	[01]
Kind	Value				
pattern	[01]				

element **Fuori_Assistenza_Type/AnomaliaFabbricati**

diagram					
namespace	urn:www.agenziaentrate.gov.it:specificheTecniche:sco:730				
type	DatoCB_Type				
facets	<table border="1"> <tr> <td>Kind</td> <td>Value</td> </tr> <tr> <td>pattern</td> <td>[01]</td> </tr> </table>	Kind	Value	pattern	[01]
Kind	Value				
pattern	[01]				

element **Fuori_Assistenza_Type/AnomaliaLavDip**

diagram	
namespace	urn:www.agenziaentrate.gov.it:specificheTecniche:sco:730
type	DatoCB_Type
facets	Kind Value pattern [01]

element **Fuori_Assistenza_Type/AnomaliaAltriRedditi**

diagram	
namespace	urn:www.agenziaentrate.gov.it:specificheTecniche:sco:730
type	DatoCB_Type
facets	Kind Value pattern [01]

element **Fuori_Assistenza_Type/AnomaliaQuadroF**

diagram	
namespace	urn:www.agenziaentrate.gov.it:specificheTecniche:sco:730
type	DatoCB_Type
facets	Kind Value pattern [01]

complexType **Giorni_Percentuale_Type**

diagram	
namespace	urn:www.agenziaentrate.gov.it:specificheTecniche:sco:730
children	m730:Giorni m730:Percentuale

element **Giorni_Percentuale_Type/Giorni**

diagram	
namespace	urn:www.agenziaentrate.gov.it:specificheTecniche:sco:730
type	DatoNP_Type
facets	Kind Value pattern [1-9]{1}[0-9]*

element **Giorni_Percentuale_Type/Percentuale**

diagram					
namespace	urn:www.agenziaentrate.gov.it:specificheTecniche:sco:730				
type	DatoPC_Type				
facets	<table border="1"> <thead> <tr> <th>Kind</th> <th>Value</th> </tr> </thead> <tbody> <tr> <td>pattern</td> <td>[0-9]?[0-9](,\d{1,3})? 100,0{1,3}?</td> </tr> </tbody> </table>	Kind	Value	pattern	[0-9]?[0-9](,\d{1,3})? 100,0{1,3}?
Kind	Value				
pattern	[0-9]?[0-9](,\d{1,3})? 100,0{1,3}?				

complexType **Importi_Rimborsare_730-4_Integrativo_Type**

diagram	
namespace	urn:www.agenziaentrate.gov.it:specificheTecniche:sco:730
type	extension of m730:Importi_Rimborsare_730-4_Type
children	m730:IrpefRimborsare m730:AddRegRimborsare m730:AddComRimborsare m730:CedolareRimborsare m730:TassazioneSepRimborsare m730:PremiRisultatoRimborsare m730:ContributoSolidarieta

element **Importi_Rimborsare_730-4_Integrativo_Type/TassazioneSepRimborsare**

diagram	
namespace	urn:www.agenziaentrate.gov.it:specificheTecniche:sco:730
type	m730:Importo_730-4

children	m730:ImportoDichiarante m730:ImportoConiuge m730:ImportoTotale
----------	--

element **Importi_Rimborsare_730-4_Integrativo_Type/PremiRisultatoRimborsare**

diagram	
namespace	urn:www.agenziaentrate.gov.it:specificheTecniche:sco:730
type	m730:Importo_730-4
children	m730:ImportoDichiarante m730:ImportoConiuge m730:ImportoTotale

element **Importi_Rimborsare_730-4_Integrativo_Type/ContributoSolidarieta**

diagram	
namespace	urn:www.agenziaentrate.gov.it:specificheTecniche:sco:730
type	m730:Importo_730-4
children	m730:ImportoDichiarante m730:ImportoConiuge m730:ImportoTotale

complexType **Importi_Rimborsare_730-4_Type**

diagram	
namespace	urn:www.agenziaentrate.gov.it:specificheTecniche:sco:730
children	m730:IrpefRimborsare m730:AddRegRimborsare m730:AddComRimborsare m730:CedolareRimborsare

element **Importi_Rimborsare_730-4_Type/IprefRimborsare**

diagram	
namespace	urn:www.agenziaentrate.gov.it:specificheTecniche:sco:730
type	m730:Importo_730-4
children	m730:ImportoDichiarante m730:ImportoConiuge m730:ImportoTotale

element **Importi_Rimborsare_730-4_Type/AddRegRimborsare**

diagram	
namespace	urn:www.agenziaentrate.gov.it:specificheTecniche:sco:730
children	m730:ImportoAddizionale m730:CodiceRegioneDichiarante m730:CodiceRegioneConiuge

element **Importi_Rimborsare_730-4_Type/AddRegRimborsare/ImportoAddizionale**

diagram	
namespace	urn:www.agenziaentrate.gov.it:specificheTecniche:sco:730
type	m730:Importo_730-4
children	m730:ImportoDichiarante m730:ImportoConiuge m730:ImportoTotale

element **Importi_Rimborsare_730-4_Type/AddRegRimborsare/CodiceRegioneDichiarante**

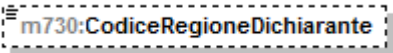
diagram																																															
namespace	urn:www.agenziaentrate.gov.it:specificheTecniche:sco:730																																														
type	Codice Regione Type																																														
facets	<table border="1"> <thead> <tr> <th>Kind</th> <th>Value</th> </tr> </thead> <tbody> <tr> <td>pattern</td> <td>(([0-9A-Z\-\]]&quot;){1}([0-9A-Z&amp;]] \- \., /° °\°\(\)À É É ì ò ù Û &quot;; \\N \\+)*</td> </tr> <tr><td>enumeration</td><td>1</td></tr> <tr><td>enumeration</td><td>2</td></tr> <tr><td>enumeration</td><td>3</td></tr> <tr><td>enumeration</td><td>4</td></tr> <tr><td>enumeration</td><td>5</td></tr> <tr><td>enumeration</td><td>6</td></tr> <tr><td>enumeration</td><td>7</td></tr> <tr><td>enumeration</td><td>8</td></tr> <tr><td>enumeration</td><td>9</td></tr> <tr><td>enumeration</td><td>10</td></tr> <tr><td>enumeration</td><td>11</td></tr> <tr><td>enumeration</td><td>12</td></tr> <tr><td>enumeration</td><td>13</td></tr> <tr><td>enumeration</td><td>14</td></tr> <tr><td>enumeration</td><td>15</td></tr> <tr><td>enumeration</td><td>16</td></tr> <tr><td>enumeration</td><td>17</td></tr> <tr><td>enumeration</td><td>18</td></tr> <tr><td>enumeration</td><td>19</td></tr> <tr><td>enumeration</td><td>20</td></tr> <tr><td>enumeration</td><td>21</td></tr> </tbody> </table>	Kind	Value	pattern	(([0-9A-Z\-\]]"){1}([0-9A-Z&]] \- \., /° °\°\(\)À É É ì ò ù Û "; \\N \\+)*	enumeration	1	enumeration	2	enumeration	3	enumeration	4	enumeration	5	enumeration	6	enumeration	7	enumeration	8	enumeration	9	enumeration	10	enumeration	11	enumeration	12	enumeration	13	enumeration	14	enumeration	15	enumeration	16	enumeration	17	enumeration	18	enumeration	19	enumeration	20	enumeration	21
Kind	Value																																														
pattern	(([0-9A-Z\-\]]"){1}([0-9A-Z&]] \- \., /° °\°\(\)À É É ì ò ù Û "; \\N \\+)*																																														
enumeration	1																																														
enumeration	2																																														
enumeration	3																																														
enumeration	4																																														
enumeration	5																																														
enumeration	6																																														
enumeration	7																																														
enumeration	8																																														
enumeration	9																																														
enumeration	10																																														
enumeration	11																																														
enumeration	12																																														
enumeration	13																																														
enumeration	14																																														
enumeration	15																																														
enumeration	16																																														
enumeration	17																																														
enumeration	18																																														
enumeration	19																																														
enumeration	20																																														
enumeration	21																																														

element **Importi_Rimborsare_730-4_Type/AddRegRimborsare/CodiceRegioneConiuge**

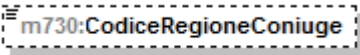
diagram																																															
namespace	urn:www.agenziaentrate.gov.it:specificheTecniche:sco:730																																														
type	Codice Regione Type																																														
facets	<table border="1"> <thead> <tr> <th>Kind</th> <th>Value</th> </tr> </thead> <tbody> <tr> <td>pattern</td> <td>(([0-9A-Z\-\]]&quot;){1}([0-9A-Z&amp;]] \- \., /° °\°\(\)À É É ì ò ù Û &quot;; \\N \\+)*</td> </tr> <tr><td>enumeration</td><td>1</td></tr> <tr><td>enumeration</td><td>2</td></tr> <tr><td>enumeration</td><td>3</td></tr> <tr><td>enumeration</td><td>4</td></tr> <tr><td>enumeration</td><td>5</td></tr> <tr><td>enumeration</td><td>6</td></tr> <tr><td>enumeration</td><td>7</td></tr> <tr><td>enumeration</td><td>8</td></tr> <tr><td>enumeration</td><td>9</td></tr> <tr><td>enumeration</td><td>10</td></tr> <tr><td>enumeration</td><td>11</td></tr> <tr><td>enumeration</td><td>12</td></tr> <tr><td>enumeration</td><td>13</td></tr> <tr><td>enumeration</td><td>14</td></tr> <tr><td>enumeration</td><td>15</td></tr> <tr><td>enumeration</td><td>16</td></tr> <tr><td>enumeration</td><td>17</td></tr> <tr><td>enumeration</td><td>18</td></tr> <tr><td>enumeration</td><td>19</td></tr> <tr><td>enumeration</td><td>20</td></tr> <tr><td>enumeration</td><td>21</td></tr> </tbody> </table>	Kind	Value	pattern	(([0-9A-Z\-\]]"){1}([0-9A-Z&]] \- \., /° °\°\(\)À É É ì ò ù Û "; \\N \\+)*	enumeration	1	enumeration	2	enumeration	3	enumeration	4	enumeration	5	enumeration	6	enumeration	7	enumeration	8	enumeration	9	enumeration	10	enumeration	11	enumeration	12	enumeration	13	enumeration	14	enumeration	15	enumeration	16	enumeration	17	enumeration	18	enumeration	19	enumeration	20	enumeration	21
Kind	Value																																														
pattern	(([0-9A-Z\-\]]"){1}([0-9A-Z&]] \- \., /° °\°\(\)À É É ì ò ù Û "; \\N \\+)*																																														
enumeration	1																																														
enumeration	2																																														
enumeration	3																																														
enumeration	4																																														
enumeration	5																																														
enumeration	6																																														
enumeration	7																																														
enumeration	8																																														
enumeration	9																																														
enumeration	10																																														
enumeration	11																																														
enumeration	12																																														
enumeration	13																																														
enumeration	14																																														
enumeration	15																																														
enumeration	16																																														
enumeration	17																																														
enumeration	18																																														
enumeration	19																																														
enumeration	20																																														
enumeration	21																																														

element **Importi_Rimborsare_730-4_Type/AddComRimborsare**

diagram	
namespace	urn:www.agenziaentrate.gov.it:specificheTecniche:sco:730
children	m730:ImportoAddizionale m730:CodiceComuneDichiarante m730:CodiceComuneConiuge

element **Importi_Rimborsare_730-4_Type/AddComRimborsare/ImportoAddizionale**

diagram	
namespace	urn:www.agenziaentrate.gov.it:specificheTecniche:sco:730
type	m730:Importo_730-4
children	m730:ImportoDichiarante m730:ImportoConiuge m730:ImportoTotale

element **Importi_Rimborsare_730-4_Type/AddComRimborsare/CodiceComuneDichiarante**

diagram					
namespace	urn:www.agenziaentrate.gov.it:specificheTecniche:sco:730				
type	DatoAN_Type				
facets	<table border="1"> <thead> <tr> <th>Kind</th> <th>Value</th> </tr> </thead> <tbody> <tr> <td>pattern</td> <td>([0-9A-Z\-\&quot;]{1})([0-9A-Z&amp;] '\- \., /'°\^\(\)\ À È É Ì Ò Ù Û &quot; \ \ /+)*</td> </tr> </tbody> </table>	Kind	Value	pattern	([0-9A-Z\-\"]{1})([0-9A-Z&] '\- \., /'°\^\(\)\ À È É Ì Ò Ù Û " \ \ /+)*
Kind	Value				
pattern	([0-9A-Z\-\"]{1})([0-9A-Z&] '\- \., /'°\^\(\)\ À È É Ì Ò Ù Û " \ \ /+)*				

element **Importi_Rimborsare_730-4_Type/AddComRimborsare/CodiceComuneConiuge**

diagram					
namespace	urn:www.agenziaentrate.gov.it:specificheTecniche:sco:730				
type	DatoAN_Type				
facets	<table border="1"> <thead> <tr> <th>Kind</th> <th>Value</th> </tr> </thead> <tbody> <tr> <td>pattern</td> <td>([0-9A-Z\-\&quot;]{1})([0-9A-Z&amp;] '\- \., /'°\^\(\)\ À È É Ì Ò Ù Û &quot; \ \ /+)*</td> </tr> </tbody> </table>	Kind	Value	pattern	([0-9A-Z\-\"]{1})([0-9A-Z&] '\- \., /'°\^\(\)\ À È É Ì Ò Ù Û " \ \ /+)*
Kind	Value				
pattern	([0-9A-Z\-\"]{1})([0-9A-Z&] '\- \., /'°\^\(\)\ À È É Ì Ò Ù Û " \ \ /+)*				

element **Importi_Rimborsare_730-4_Type/CedolareRimborsare**

diagram	
namespace	urn:www.agenziaentrate.gov.it:specificheTecniche:sco:730
type	m730:Importo_730-4
children	m730:ImportoDichiarante m730:ImportoConiuge m730:ImportoTotale

complexType **Importi_Trattenere_730-4_Type**

diagram	
namespace	urn:www.agenziaentrate.gov.it:specificheTecniche:sco:730
children	m730:IrpefTrattenere m730:AddRegTrattenere m730:AddComTrattenere m730:IrpefPrimaRataTrattenere m730:IrpefSecondaRataTrattenere m730:TassSepAccontoTrattenere m730:AddComAccontoTrattenere m730:PremiRisultatoTrattenere m730:CedolareTrattenere m730:CedolarePrimaRataTrattenere m730:CedolareSecondaRataTrattenere m730:ContribSolidTrattenere

element **Importi_Trattenere_730-4_Type/IrpefTrattenere**

diagram	
namespace	urn:www.agenziaentrate.gov.it:specificheTecniche:sco:730
type	m730:Importo_730-4
children	m730:ImportoDichiarante m730:ImportoConiuge m730:ImportoTotale

element **Importi_Trattenere_730-4_Type/AddRegTrattenere**

diagram	
namespace	urn:www.agenziaentrate.gov.it:specificheTecniche:sco:730
children	m730:ImportoAddizionale m730:CodiceRegioneDichiarante m730:CodiceRegioneConiuge

element **Importi_Trattenere_730-4_Type/AddRegTrattenere/ImportoAddizionale**

diagram	
namespace	urn:www.agenziaentrate.gov.it:specificheTecniche:sco:730
type	m730:Importo_730-4
children	m730:ImportoDichiarante m730:ImportoConiuge m730:ImportoTotale

element **Importi_Trattenere_730-4_Type/AddRegTrattenere/CodiceRegioneDichiarante**

diagram	
---------	--

namespace	urn:www.agenziaentrate.gov.it:specificheTecniche:sco:730	
type	Codice Regione Type	
facets	Kind	Value
	pattern	{([0-9A-Z-])"}{1}([0-9A-Z&:] ' - \., / ° ^\(\\)À É Ê Ï Ò Ù Ü ";\\N \\+)*
	enumeration	1
	enumeration	2
	enumeration	3
	enumeration	4
	enumeration	5
	enumeration	6
	enumeration	7
	enumeration	8
	enumeration	9
	enumeration	10
	enumeration	11
	enumeration	12
	enumeration	13
	enumeration	14
	enumeration	15
	enumeration	16
	enumeration	17
	enumeration	18
	enumeration	19
	enumeration	20
	enumeration	21

element **Importi Tratteneri_730-4_Type/AddRegTratteneri/CodiceRegioneConiuge**

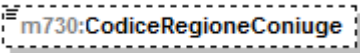
diagram		
namespace	urn:www.agenziaentrate.gov.it:specificheTecniche:sco:730	
type	Codice Regione Type	
facets	Kind	Value
	pattern	{([0-9A-Z-])"}{1}([0-9A-Z&:] ' - \., / ° ^\(\\)À É Ê Ï Ò Ù Ü ";\\N \\+)*
	enumeration	1
	enumeration	2
	enumeration	3
	enumeration	4
	enumeration	5
	enumeration	6
	enumeration	7
	enumeration	8
	enumeration	9
	enumeration	10
	enumeration	11
	enumeration	12
	enumeration	13
	enumeration	14
	enumeration	15
	enumeration	16
	enumeration	17
	enumeration	18
	enumeration	19
	enumeration	20
	enumeration	21

element **Importi_Trattenerere_730-4_Type/AddComTrattenerere**

diagram	
namespace	urn:www.agenziaentrate.gov.it:specificheTecniche:sco:730
children	m730:ImportoAddizionale m730:CodiceComuneDichiarante m730:CodiceComuneConiuge

element **Importi_Trattenerere_730-4_Type/AddComTrattenerere/ImportoAddizionale**

diagram	
namespace	urn:www.agenziaentrate.gov.it:specificheTecniche:sco:730
type	m730:Importo_730-4
children	m730:ImportoDichiarante m730:ImportoConiuge m730:ImportoTotale

element **Importi_Trattenerere_730-4_Type/AddComTrattenerere/CodiceComuneDichiarante**

diagram					
namespace	urn:www.agenziaentrate.gov.it:specificheTecniche:sco:730				
type	DatoAN_Type				
facets	<table border="0"> <tr> <td>Kind</td> <td>Value</td> </tr> <tr> <td>pattern</td> <td>(([0-9A-Z\-_]&quot;){1}([0-9A-Z&amp;#39; ! - \- _ / ° °\°\(\)\ À È É Ì Ò Ù Ú Û &quot;; \\ / +)*</td> </tr> </table>	Kind	Value	pattern	(([0-9A-Z\-_]"){1}([0-9A-Z&#39; ! - \- _ / ° °\°\(\)\ À È É Ì Ò Ù Ú Û "; \\ / +)*
Kind	Value				
pattern	(([0-9A-Z\-_]"){1}([0-9A-Z&#39; ! - \- _ / ° °\°\(\)\ À È É Ì Ò Ù Ú Û "; \\ / +)*				

element **Importi_Trattenerere_730-4_Type/AddComTrattenerere/CodiceComuneConiuge**

diagram					
namespace	urn:www.agenziaentrate.gov.it:specificheTecniche:sco:730				
type	DatoAN_Type				
facets	<table border="0"> <tr> <td>Kind</td> <td>Value</td> </tr> <tr> <td>pattern</td> <td>(([0-9A-Z\-_]&quot;){1}([0-9A-Z&amp;#39; ! - \- _ / ° °\°\(\)\ À È É Ì Ò Ù Ú Û &quot;; \\ / +)*</td> </tr> </table>	Kind	Value	pattern	(([0-9A-Z\-_]"){1}([0-9A-Z&#39; ! - \- _ / ° °\°\(\)\ À È É Ì Ò Ù Ú Û "; \\ / +)*
Kind	Value				
pattern	(([0-9A-Z\-_]"){1}([0-9A-Z&#39; ! - \- _ / ° °\°\(\)\ À È É Ì Ò Ù Ú Û "; \\ / +)*				

element **Importi_Trattenere_730-4_Type/IrpefPrimaRataTrattenere**

diagram	
namespace	urn:www.agenziaentrate.gov.it:specificheTecniche:sco:730
type	m730:Importo_730-4
children	m730:ImportoDichiarante m730:ImportoConiuge m730:ImportoTotale

element **Importi_Trattenere_730-4_Type/IrpefSecondaRataTrattenere**

diagram	
namespace	urn:www.agenziaentrate.gov.it:specificheTecniche:sco:730
type	m730:Importo_730-4
children	m730:ImportoDichiarante m730:ImportoConiuge m730:ImportoTotale

element **Importi_Trattenere_730-4_Type/TassSepAccontoTrattenere**

diagram	
namespace	urn:www.agenziaentrate.gov.it:specificheTecniche:sco:730
type	m730:Importo_730-4
children	m730:ImportoDichiarante m730:ImportoConiuge m730:ImportoTotale

element **Importi_Trattenere_730-4_Type/AddComAccontoTrattenere**

diagram	
namespace	urn:www.agenziaentrate.gov.it:specificheTecniche:sco:730
children	m730:ImportoAddizionale m730:CodiceComuneDichiarante m730:CodiceComuneConiuge

element **Importi_Trattenere_730-4_Type/AddComAccontoTrattenere/ImportoAddizionale**

diagram	
namespace	urn:www.agenziaentrate.gov.it:specificheTecniche:sco:730
type	m730:Importo_730-4
children	m730:ImportoDichiarante m730:ImportoConiuge m730:ImportoTotale

element **Importi_Trattenere_730-4_Type/AddComAccontoTrattenere/CodiceComuneDichiarante**

diagram					
namespace	urn:www.agenziaentrate.gov.it:specificheTecniche:sco:730				
type	DatoAN_Type				
facets	<table border="1"> <thead> <tr> <th>Kind</th> <th>Value</th> </tr> </thead> <tbody> <tr> <td>pattern</td> <td>([0-9A-Z\-\ &quot;]{1})([0-9A-Z&amp;] '\ -\ \. , ' ^\ \\(\) À È É Ì Ò Ù Ú &quot;; \\ / +)*</td> </tr> </tbody> </table>	Kind	Value	pattern	([0-9A-Z\-\ "]{1})([0-9A-Z&] '\ -\ \. , ' ^\ \\(\) À È É Ì Ò Ù Ú "; \\ / +)*
Kind	Value				
pattern	([0-9A-Z\-\ "]{1})([0-9A-Z&] '\ -\ \. , ' ^\ \\(\) À È É Ì Ò Ù Ú "; \\ / +)*				

element **Importi_Trattenere_730-4_Type/AddComAccontoTrattenere/CodiceComuneConiuge**

diagram					
namespace	urn:www.agenziaentrate.gov.it:specificheTecniche:sco:730				
type	DatoAN_Type				
facets	<table border="1"> <thead> <tr> <th>Kind</th> <th>Value</th> </tr> </thead> <tbody> <tr> <td>pattern</td> <td>([0-9A-Z\-\ &quot;]{1})([0-9A-Z&amp;] '\ -\ \. , ' ^\ \\(\) À È É Ì Ò Ù Ú &quot;; \\ / +)*</td> </tr> </tbody> </table>	Kind	Value	pattern	([0-9A-Z\-\ "]{1})([0-9A-Z&] '\ -\ \. , ' ^\ \\(\) À È É Ì Ò Ù Ú "; \\ / +)*
Kind	Value				
pattern	([0-9A-Z\-\ "]{1})([0-9A-Z&] '\ -\ \. , ' ^\ \\(\) À È É Ì Ò Ù Ú "; \\ / +)*				

element **Importi_Trattenere_730-4_Type/PremiRisultatoTrattenere**

diagram	
namespace	urn:www.agenziaentrate.gov.it:specificheTecniche:sco:730
type	m730:Importo_730-4
children	m730:ImportoDichiarante m730:ImportoConiuge m730:ImportoTotale

element **Importi_Trattenere_730-4_Type/CedolareTrattenere**

diagram	
namespace	urn:www.agenziaentrate.gov.it:specificheTecniche:sco:730
type	m730:Importo_730-4
children	m730:ImportoDichiarante m730:ImportoConiuge m730:ImportoTotale

element **Importi_Trattenere_730-4_Type/CedolarePrimaRataTrattenere**

diagram	
namespace	urn:www.agenziaentrate.gov.it:specificheTecniche:sco:730
type	m730:Importo_730-4
children	m730:ImportoDichiarante m730:ImportoConiuge m730:ImportoTotale

element **Importi_Trattenere_730-4_Type/CedolareSecondaRataTrattenere**

diagram	
namespace	urn:www.agenziaentrate.gov.it:specificheTecniche:sco:730
type	m730:Importo_730-4
children	m730:ImportoDichiarante m730:ImportoConiuge m730:ImportoTotale

element **Importi_Trattenere_730-4_Type/ContribSolidTrattenere**

diagram	
namespace	urn:www.agenziaentrate.gov.it:specificheTecniche:sco:730
type	m730:Importo_730-4
children	m730:ImportoDichiarante m730:ImportoConiuge m730:ImportoTotale

complexType **Importo_730-4**

diagram	
namespace	urn:www.agenziaentrate.gov.it:specificheTecniche:sco:730
children	m730:ImportoDichiarante m730:ImportoConiuge m730:ImportoTotale

element **Importo_730-4/ImportoDichiarante**

diagram	
---------	--

namespace	urn:www.agenziaentrate.gov.it:specificheTecniche:sco:730
type	DatoNP_Type
facets	Kind Value pattern [1-9]{1}[0-9]*

element **Importo_730-4/ImportoConiuge**

diagram	
namespace	urn:www.agenziaentrate.gov.it:specificheTecniche:sco:730
type	DatoNP_Type
facets	Kind Value pattern [1-9]{1}[0-9]*

element **Importo_730-4/ImportoTotale**

diagram	
namespace	urn:www.agenziaentrate.gov.it:specificheTecniche:sco:730
type	DatoNP_Type
facets	Kind Value pattern [1-9]{1}[0-9]*

complexType **Imposta_Lorda_Type**

diagram	
namespace	urn:www.agenziaentrate.gov.it:specificheTecniche:sco:730
children	m730:RedditoComplessivo m730:DeduzioneAbitazPrincipale m730:OneriDeducibili m730:RedditoImponibile m730:CompensiAttSport m730:ImportoImpostaLorda

element **Imposta_Lorda_Type/RedditoComplessivo**

diagram	
---------	--

namespace	urn:www.agenziaentrate.gov.it:specificheTecniche:sco:730
type	DatoNP_Type
facets	Kind Value pattern [1-9]{1}[0-9]*

element **Imposta_Lorda_Type/DeduzioneAbitazPrincipale**

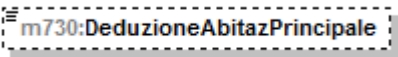
diagram	
namespace	urn:www.agenziaentrate.gov.it:specificheTecniche:sco:730
type	DatoNP_Type
facets	Kind Value pattern [1-9]{1}[0-9]*

element **Imposta_Lorda_Type/OneriDeducibili**

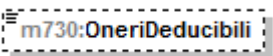
diagram	
namespace	urn:www.agenziaentrate.gov.it:specificheTecniche:sco:730
type	DatoNP_Type
facets	Kind Value pattern [1-9]{1}[0-9]*

element **Imposta_Lorda_Type/RedditoImponibile**

diagram	
namespace	urn:www.agenziaentrate.gov.it:specificheTecniche:sco:730
type	DatoNP_Type
facets	Kind Value pattern [1-9]{1}[0-9]*

element **Imposta_Lorda_Type/CompensiAttSport**

diagram	
namespace	urn:www.agenziaentrate.gov.it:specificheTecniche:sco:730
type	DatoNP_Type
facets	Kind Value pattern [1-9]{1}[0-9]*

element **Imposta_Lorda_Type/ImportoImpostaLorda**

diagram	
namespace	urn:www.agenziaentrate.gov.it:specificheTecniche:sco:730
type	DatoNP_Type
facets	Kind Value pattern [1-9]{1}[0-9]*

complexType **Imposta_Netta_Type**

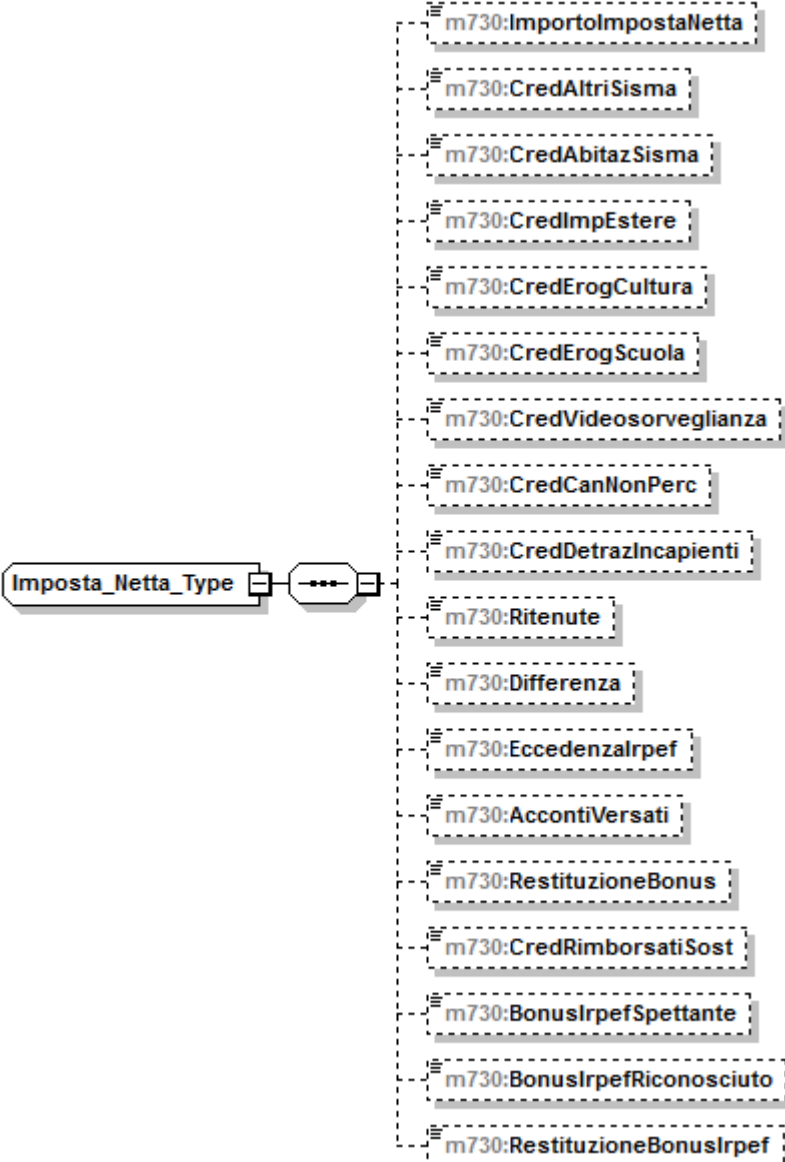
diagram	
namespace	urn:www.agenziaentrate.gov.it:specificheTecniche:sco:730
children	m730:ImportoImpostaNetta m730:CredAltriSisma m730:CredAbitazSisma m730:CredImpEstere

	m730:CredErogCultura m730:CredErogScuola m730:CredVideosorveglianza m730:CredCanNonPerc m730:CredDetrazIncapienti m730:Ritenute m730:Differenza m730:EccedenzaIrpef m730:AccontiVersati m730:RestituzioneBonus m730:CredRimborsatiSost m730:BonusIrpefSpettante m730:BonusIrpefRiconosciuto m730:RestituzioneBonusIrpef
--	---

element **Imposta_Netta_Type/ImportoImpostaNetta**

diagram	
namespace	urn:www.agenziaentrate.gov.it:specificheTecniche:sco:730
type	DatoNP_Type
facets	Kind Value pattern [1-9]{1}[0-9]*

element **Imposta_Netta_Type/CredAltriSisma**

diagram	
namespace	urn:www.agenziaentrate.gov.it:specificheTecniche:sco:730
type	DatoNP_Type
facets	Kind Value pattern [1-9]{1}[0-9]*

element **Imposta_Netta_Type/CredAbitazSisma**

diagram	
namespace	urn:www.agenziaentrate.gov.it:specificheTecniche:sco:730
type	DatoNP_Type
facets	Kind Value pattern [1-9]{1}[0-9]*

element **Imposta_Netta_Type/CredImpEstere**

diagram	
namespace	urn:www.agenziaentrate.gov.it:specificheTecniche:sco:730
type	DatoNP_Type
facets	Kind Value pattern [1-9]{1}[0-9]*

element **Imposta_Netta_Type/CredErogCultura**

diagram	
---------	--

namespace	urn:www.agenziaentrate.gov.it:specificheTecniche:sco:730
type	DatoNP_Type
facets	Kind Value pattern [1-9]{1}[0-9]*

element **Imposta_Netta_Type/CredErogScuola**

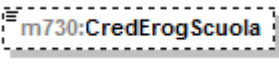
diagram	
namespace	urn:www.agenziaentrate.gov.it:specificheTecniche:sco:730
type	DatoNP_Type
facets	Kind Value pattern [1-9]{1}[0-9]*

element **Imposta_Netta_Type/CredVideosorveglianza**

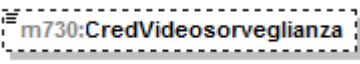
diagram	
namespace	urn:www.agenziaentrate.gov.it:specificheTecniche:sco:730
type	DatoNP_Type
facets	Kind Value pattern [1-9]{1}[0-9]*

element **Imposta_Netta_Type/CredCanNonPerc**

diagram	
namespace	urn:www.agenziaentrate.gov.it:specificheTecniche:sco:730
type	DatoNP_Type
facets	Kind Value pattern [1-9]{1}[0-9]*

element **Imposta_Netta_Type/CredDetrazIncapienti**

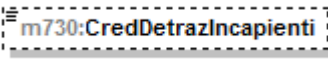
diagram	
namespace	urn:www.agenziaentrate.gov.it:specificheTecniche:sco:730
type	DatoNP_Type
facets	Kind Value pattern [1-9]{1}[0-9]*

element **Imposta_Netta_Type/Ritenute**

diagram	
namespace	urn:www.agenziaentrate.gov.it:specificheTecniche:sco:730
type	DatoNP_Type
facets	Kind Value pattern [1-9]{1}[0-9]*

element **Imposta_Netta_Type/Differenza**

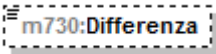
diagram	
namespace	urn:www.agenziaentrate.gov.it:specificheTecniche:sco:730
type	DatoNU_Type
facets	Kind Value pattern (\-[1-9] [1-9])[0-9]*

element **Imposta_Netta_Type/EccedenzaIrpef**

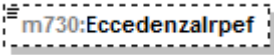
diagram	
namespace	urn:www.agenziaentrate.gov.it:specificheTecniche:sco:730
type	DatoNU_Type
facets	Kind Value pattern (\-[1-9] [1-9])[0-9]*

element **Imposta_Netta_Type/AccountiVersati**

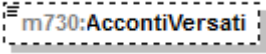
diagram	
namespace	urn:www.agenziaentrate.gov.it:specificheTecniche:sco:730
type	DatoNP_Type
facets	Kind Value pattern [1-9]{1}[0-9]*

element **Imposta_Netta_Type/RestituzioneBonus**

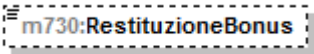
diagram	
namespace	urn:www.agenziaentrate.gov.it:specificheTecniche:sco:730
type	DatoNP_Type
facets	Kind Value pattern [1-9]{1}[0-9]*

element **Imposta_Netta_Type/CredRimborsatiSost**

diagram	
namespace	urn:www.agenziaentrate.gov.it:specificheTecniche:sco:730
type	DatoNP_Type
facets	Kind Value pattern [1-9]{1}[0-9]*

element **Imposta_Netta_Type/BonuslrpefSpettante**

diagram	
namespace	urn:www.agenziaentrate.gov.it:specificheTecniche:sco:730
type	DatoNP_Type
facets	Kind Value pattern [1-9]{1}[0-9]*

element **Imposta_Netta_Type/BonuslrpefRiconosciuto**

diagram	
namespace	urn:www.agenziaentrate.gov.it:specificheTecniche:sco:730
type	DatoNP_Type
facets	Kind Value pattern [1-9]{1}[0-9]*

element **Imposta_Netta_Type/RestituzioneBonuslrpef**

diagram	
namespace	urn:www.agenziaentrate.gov.it:specificheTecniche:sco:730
type	DatoNP_Type
facets	Kind Value pattern [1-9]{1}[0-9]*

complexType **Imposte_Rimborsate_Type**

diagram	
namespace	urn:www.agenziaentrate.gov.it:specificheTecniche:sco:730
children	m730:TipoReddito m730:TassazioneSeparata

element **Imposte_Rimborsate_Type/TipoReddito**

diagram																					
namespace	urn:www.agenziaentrate.gov.it:specificheTecniche:sco:730																				
type	m730:Tipo_Reddito_Da1a8_Type																				
facets	<table border="0"> <tr> <td>Kind</td> <td>Value</td> </tr> <tr> <td>pattern</td> <td>[1-9]{1}[0-9]*</td> </tr> <tr> <td>enumeration</td> <td>1</td> </tr> <tr> <td>enumeration</td> <td>2</td> </tr> <tr> <td>enumeration</td> <td>3</td> </tr> <tr> <td>enumeration</td> <td>4</td> </tr> <tr> <td>enumeration</td> <td>5</td> </tr> <tr> <td>enumeration</td> <td>6</td> </tr> <tr> <td>enumeration</td> <td>7</td> </tr> <tr> <td>enumeration</td> <td>8</td> </tr> </table>	Kind	Value	pattern	[1-9]{1}[0-9]*	enumeration	1	enumeration	2	enumeration	3	enumeration	4	enumeration	5	enumeration	6	enumeration	7	enumeration	8
Kind	Value																				
pattern	[1-9]{1}[0-9]*																				
enumeration	1																				
enumeration	2																				
enumeration	3																				
enumeration	4																				
enumeration	5																				
enumeration	6																				
enumeration	7																				
enumeration	8																				

element **Imposte_Rimborsate_Type/TassazioneSeparata**

diagram	
namespace	urn:www.agenziaentrate.gov.it:specificheTecniche:sco:730
type	m730:Tassazione_Separata_Type
children	m730:Opzione m730:Anno m730:RedditoRitenute

complexType **Inquilini_Abitazione_Principale_Type**

diagram	
namespace	urn:www.agenziaentrate.gov.it:specificheTecniche:sco:730
children	m730:Tipologia m730:GiorniPercentuale

element **Inquilini_Abitazione_Principale_Type/Tipologia**

diagram	
---------	--

namespace	urn:www.agenziaentrate.gov.it:specificheTecniche:sco:730	
type	m730:Tipo_Inquilino_Type	
facets	Kind	Value
	pattern	[1-9]{1}[0-9]*
	enumeration	1
	enumeration	2
	enumeration	3
	enumeration	4

element [Inquilini_Abitazione_Principale_Type/GiorniPercentuale](#)

diagram	<p>The diagram shows a box labeled 'm730:GiorniPercentuale' connected to a sequence container (a rounded rectangle with three dots). This container is linked to two child elements: 'm730:Giorni' and 'm730:Percentuale'. A dashed yellow box labeled 'm730:Giorni_Percentuale_Type' encloses the sequence container and its two children.</p>	
namespace	urn:www.agenziaentrate.gov.it:specificheTecniche:sco:730	
type	m730:Giorni_Percentuale_Type	
children	m730:Giorni m730:Percentuale	

complexType [Intervento_Recupero_Patrimonio_Edilizio_Type](#)

diagram	<p>The diagram shows a box labeled 'Intervento_Recupero_Patrimoni...' connected to a sequence container (a rounded rectangle with three dots). This container is linked to eight child elements: 'm730:Anno', 'm730:Periodo', 'm730:CodiceFiscale', 'm730:CasellaInterventiParticolari', 'm730:CodiceSituazioniParticolari', 'm730:Rate10', 'm730:Spesa', and 'm730:NOrdineImmobile'. Dashed lines connect the sequence container to each child element.</p>	
namespace	urn:www.agenziaentrate.gov.it:specificheTecniche:sco:730	
children	m730:Anno m730:Periodo m730:CodiceFiscale m730:CasellaInterventiParticolari m730:CodiceSituazioniParticolari m730:Rate10 m730:Spesa m730:NOrdineImmobile	

element **Intervento_Ricupero_Patrimonio_Edificio_Type/Anno**

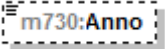
diagram																									
namespace	urn:www.agenziaentrate.gov.it:specificheTecniche:sco:730																								
type	m730:Anno_Ricupero_Patrimonio_Edificio_Type																								
facets	<table border="1"> <thead> <tr> <th>Kind</th> <th>Value</th> </tr> </thead> <tbody> <tr> <td>pattern</td> <td>[1-9]{1}[0-9]*</td> </tr> <tr> <td>enumeration</td> <td>2007</td> </tr> <tr> <td>enumeration</td> <td>2008</td> </tr> <tr> <td>enumeration</td> <td>2009</td> </tr> <tr> <td>enumeration</td> <td>2010</td> </tr> <tr> <td>enumeration</td> <td>2011</td> </tr> <tr> <td>enumeration</td> <td>2012</td> </tr> <tr> <td>enumeration</td> <td>2013</td> </tr> <tr> <td>enumeration</td> <td>2014</td> </tr> <tr> <td>enumeration</td> <td>2015</td> </tr> <tr> <td>enumeration</td> <td>2016</td> </tr> </tbody> </table>	Kind	Value	pattern	[1-9]{1}[0-9]*	enumeration	2007	enumeration	2008	enumeration	2009	enumeration	2010	enumeration	2011	enumeration	2012	enumeration	2013	enumeration	2014	enumeration	2015	enumeration	2016
Kind	Value																								
pattern	[1-9]{1}[0-9]*																								
enumeration	2007																								
enumeration	2008																								
enumeration	2009																								
enumeration	2010																								
enumeration	2011																								
enumeration	2012																								
enumeration	2013																								
enumeration	2014																								
enumeration	2015																								
enumeration	2016																								

element **Intervento_Ricupero_Patrimonio_Edificio_Type/Periodo**

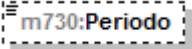
diagram											
namespace	urn:www.agenziaentrate.gov.it:specificheTecniche:sco:730										
type	m730:Periodo_Spese_Ristrutturazione_Type										
facets	<table border="1"> <thead> <tr> <th>Kind</th> <th>Value</th> </tr> </thead> <tbody> <tr> <td>pattern</td> <td>[1-9]</td> </tr> <tr> <td>enumeration</td> <td>2</td> </tr> <tr> <td>enumeration</td> <td>3</td> </tr> <tr> <td>enumeration</td> <td>4</td> </tr> </tbody> </table>	Kind	Value	pattern	[1-9]	enumeration	2	enumeration	3	enumeration	4
Kind	Value										
pattern	[1-9]										
enumeration	2										
enumeration	3										
enumeration	4										

element **Intervento_Ricupero_Patrimonio_Edificio_Type/CodiceFiscale**

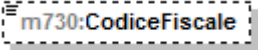
diagram					
namespace	urn:www.agenziaentrate.gov.it:specificheTecniche:sco:730				
type	DatoCF_Type				
facets	<table border="1"> <thead> <tr> <th>Kind</th> <th>Value</th> </tr> </thead> <tbody> <tr> <td>pattern</td> <td>[0-9]{11}[A-Z]{6}[0-9LMNPQRSTU]{2}[A-Z]{1}[0-9LMNPQRSTU]{2}[A-Z]{1}[0-9LMNPQRSTU]{3}[A-Z]{1}</td> </tr> </tbody> </table>	Kind	Value	pattern	[0-9]{11}[A-Z]{6}[0-9LMNPQRSTU]{2}[A-Z]{1}[0-9LMNPQRSTU]{2}[A-Z]{1}[0-9LMNPQRSTU]{3}[A-Z]{1}
Kind	Value				
pattern	[0-9]{11}[A-Z]{6}[0-9LMNPQRSTU]{2}[A-Z]{1}[0-9LMNPQRSTU]{2}[A-Z]{1}[0-9LMNPQRSTU]{3}[A-Z]{1}				

element **Intervento_Ricupero_Patrimonio_Edificio_Type/CasellaInterventiParticolari**

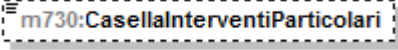
diagram									
namespace	urn:www.agenziaentrate.gov.it:specificheTecniche:sco:730								
type	restriction of DatoN1_Type								
facets	<table border="1"> <thead> <tr> <th>Kind</th> <th>Value</th> </tr> </thead> <tbody> <tr> <td>pattern</td> <td>[1-9]</td> </tr> <tr> <td>enumeration</td> <td>1</td> </tr> <tr> <td>enumeration</td> <td>4</td> </tr> </tbody> </table>	Kind	Value	pattern	[1-9]	enumeration	1	enumeration	4
Kind	Value								
pattern	[1-9]								
enumeration	1								
enumeration	4								

element **Intervento_Ricupero_Patrimonio_Edilizio_Type/CodiceSituazioniParticolari**

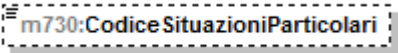
diagram							
namespace	urn:www.agenziaentrate.gov.it:specificheTecniche:sco:730						
type	restriction of DatoN1_Type						
facets	<table border="0"> <tr> <td>Kind</td> <td>Value</td> </tr> <tr> <td>pattern</td> <td>[1-9]</td> </tr> <tr> <td>enumeration</td> <td>4</td> </tr> </table>	Kind	Value	pattern	[1-9]	enumeration	4
Kind	Value						
pattern	[1-9]						
enumeration	4						

element **Intervento_Ricupero_Patrimonio_Edilizio_Type/Rate10**

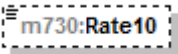
diagram																									
namespace	urn:www.agenziaentrate.gov.it:specificheTecniche:sco:730																								
type	m730:Rate10_Type																								
facets	<table border="0"> <tr> <td>Kind</td> <td>Value</td> </tr> <tr> <td>pattern</td> <td>[1-9]{1}[0-9]*</td> </tr> <tr> <td>enumeration</td> <td>1</td> </tr> <tr> <td>enumeration</td> <td>2</td> </tr> <tr> <td>enumeration</td> <td>3</td> </tr> <tr> <td>enumeration</td> <td>4</td> </tr> <tr> <td>enumeration</td> <td>5</td> </tr> <tr> <td>enumeration</td> <td>6</td> </tr> <tr> <td>enumeration</td> <td>7</td> </tr> <tr> <td>enumeration</td> <td>8</td> </tr> <tr> <td>enumeration</td> <td>9</td> </tr> <tr> <td>enumeration</td> <td>10</td> </tr> </table>	Kind	Value	pattern	[1-9]{1}[0-9]*	enumeration	1	enumeration	2	enumeration	3	enumeration	4	enumeration	5	enumeration	6	enumeration	7	enumeration	8	enumeration	9	enumeration	10
Kind	Value																								
pattern	[1-9]{1}[0-9]*																								
enumeration	1																								
enumeration	2																								
enumeration	3																								
enumeration	4																								
enumeration	5																								
enumeration	6																								
enumeration	7																								
enumeration	8																								
enumeration	9																								
enumeration	10																								

element **Intervento_Ricupero_Patrimonio_Edilizio_Type/Spesa**

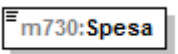
diagram					
namespace	urn:www.agenziaentrate.gov.it:specificheTecniche:sco:730				
type	DatoNP_Type				
facets	<table border="0"> <tr> <td>Kind</td> <td>Value</td> </tr> <tr> <td>pattern</td> <td>[1-9]{1}[0-9]*</td> </tr> </table>	Kind	Value	pattern	[1-9]{1}[0-9]*
Kind	Value				
pattern	[1-9]{1}[0-9]*				

element **Intervento_Ricupero_Patrimonio_Edilizio_Type/NOrdineImmobile**

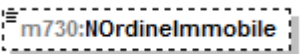
diagram					
namespace	urn:www.agenziaentrate.gov.it:specificheTecniche:sco:730				
type	DatoNP_Type				
facets	<table border="0"> <tr> <td>Kind</td> <td>Value</td> </tr> <tr> <td>pattern</td> <td>[1-9]{1}[0-9]*</td> </tr> </table>	Kind	Value	pattern	[1-9]{1}[0-9]*
Kind	Value				
pattern	[1-9]{1}[0-9]*				

complexType **Intervento_Risparmio_Energetico_Type**

diagram	
namespace	urn:www.agenziaentrate.gov.it:specificheTecniche:sco:730
children	m730:TipIntervento m730:Anno m730:Periodo2013 m730:CasiParticolari m730:RideterminazioneRate m730:RipartizioneRate m730:NumeroRata m730:Spesa

element **Intervento_Risparmio_Energetico_Type/TipIntervento**

diagram																			
namespace	urn:www.agenziaentrate.gov.it:specificheTecniche:sco:730																		
type	m730:Tipo_Intervento_Type																		
facets	<table border="1"> <thead> <tr> <th>Kind</th> <th>Value</th> </tr> </thead> <tbody> <tr> <td>pattern</td> <td>[1-9]</td> </tr> <tr> <td>enumeration</td> <td>1</td> </tr> <tr> <td>enumeration</td> <td>2</td> </tr> <tr> <td>enumeration</td> <td>3</td> </tr> <tr> <td>enumeration</td> <td>4</td> </tr> <tr> <td>enumeration</td> <td>5</td> </tr> <tr> <td>enumeration</td> <td>6</td> </tr> <tr> <td>enumeration</td> <td>7</td> </tr> </tbody> </table>	Kind	Value	pattern	[1-9]	enumeration	1	enumeration	2	enumeration	3	enumeration	4	enumeration	5	enumeration	6	enumeration	7
Kind	Value																		
pattern	[1-9]																		
enumeration	1																		
enumeration	2																		
enumeration	3																		
enumeration	4																		
enumeration	5																		
enumeration	6																		
enumeration	7																		

element **Intervento_Risparmio_Energetico_Type/Anno**

diagram															
namespace	urn:www.agenziaentrate.gov.it:specificheTecniche:sco:730														
type	m730:Anno_Risparmio_Energetico_Type														
facets	<table border="1"> <thead> <tr> <th>Kind</th> <th>Value</th> </tr> </thead> <tbody> <tr> <td>pattern</td> <td>[1-9]{1}[0-9]*</td> </tr> <tr> <td>enumeration</td> <td>2008</td> </tr> <tr> <td>enumeration</td> <td>2011</td> </tr> <tr> <td>enumeration</td> <td>2012</td> </tr> <tr> <td>enumeration</td> <td>2013</td> </tr> <tr> <td>enumeration</td> <td>2014</td> </tr> </tbody> </table>	Kind	Value	pattern	[1-9]{1}[0-9]*	enumeration	2008	enumeration	2011	enumeration	2012	enumeration	2013	enumeration	2014
Kind	Value														
pattern	[1-9]{1}[0-9]*														
enumeration	2008														
enumeration	2011														
enumeration	2012														
enumeration	2013														
enumeration	2014														

	enumeration 2015
	enumeration 2016

element **Intervento_Risparmio_Energetico_Type/Periodo2013**

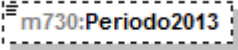
diagram									
namespace	urn:www.agenziaentrate.gov.it:specificheTecniche:sco:730								
type	restriction of DatoN1_Type								
facets	<table> <tr> <td>Kind</td> <td>Value</td> </tr> <tr> <td>pattern</td> <td>[1-9]</td> </tr> <tr> <td>enumeration</td> <td>1</td> </tr> <tr> <td>enumeration</td> <td>2</td> </tr> </table>	Kind	Value	pattern	[1-9]	enumeration	1	enumeration	2
Kind	Value								
pattern	[1-9]								
enumeration	1								
enumeration	2								

element **Intervento_Risparmio_Energetico_Type/CasiParticolari**

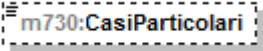
diagram											
namespace	urn:www.agenziaentrate.gov.it:specificheTecniche:sco:730										
type	m730:Casi_Particolari_Risp_Ener_Type										
facets	<table> <tr> <td>Kind</td> <td>Value</td> </tr> <tr> <td>pattern</td> <td>[1-9]</td> </tr> <tr> <td>enumeration</td> <td>1</td> </tr> <tr> <td>enumeration</td> <td>2</td> </tr> <tr> <td>enumeration</td> <td>3</td> </tr> </table>	Kind	Value	pattern	[1-9]	enumeration	1	enumeration	2	enumeration	3
Kind	Value										
pattern	[1-9]										
enumeration	1										
enumeration	2										
enumeration	3										

element **Intervento_Risparmio_Energetico_Type/RideterminazioneRate**

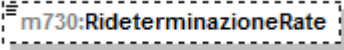
diagram																			
namespace	urn:www.agenziaentrate.gov.it:specificheTecniche:sco:730																		
type	m730:Rate_Risparmio_Energetico_Type																		
facets	<table> <tr> <td>Kind</td> <td>Value</td> </tr> <tr> <td>pattern</td> <td>[1-9]{1}[0-9]*</td> </tr> <tr> <td>enumeration</td> <td>4</td> </tr> <tr> <td>enumeration</td> <td>5</td> </tr> <tr> <td>enumeration</td> <td>6</td> </tr> <tr> <td>enumeration</td> <td>7</td> </tr> <tr> <td>enumeration</td> <td>8</td> </tr> <tr> <td>enumeration</td> <td>9</td> </tr> <tr> <td>enumeration</td> <td>10</td> </tr> </table>	Kind	Value	pattern	[1-9]{1}[0-9]*	enumeration	4	enumeration	5	enumeration	6	enumeration	7	enumeration	8	enumeration	9	enumeration	10
Kind	Value																		
pattern	[1-9]{1}[0-9]*																		
enumeration	4																		
enumeration	5																		
enumeration	6																		
enumeration	7																		
enumeration	8																		
enumeration	9																		
enumeration	10																		

element **Intervento_Risparmio_Energetico_Type/RipartizioneRate**

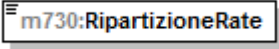
diagram			
namespace	urn:www.agenziaentrate.gov.it:specificheTecniche:sco:730		
type	m730:Ripart_Risparmio_Energetico_Type		
facets	<table> <tr> <td>Kind</td> <td>Value</td> </tr> </table>	Kind	Value
Kind	Value		

	pattern	[1-9]{1}[0-9]*
	enumeration	9
	enumeration	10

element **Intervento_Risparmio_Energetico_Type/NumeroRata**

diagram		
namespace	urn:www.agenziaentrate.gov.it:specificheTecniche:sco:730	
type	m730:Numero_Rata_Risparmio_Energetico_Type	
facets	Kind	Value
	pattern	[1-9]{1}[0-9]*
	enumeration	1
	enumeration	2
	enumeration	3
	enumeration	4
	enumeration	5
	enumeration	6
	enumeration	9

element **Intervento_Risparmio_Energetico_Type/Spesa**

diagram		
namespace	urn:www.agenziaentrate.gov.it:specificheTecniche:sco:730	
type	DatoNP_Type	
facets	Kind	Value
	pattern	[1-9]{1}[0-9]*

complexType **Iva_Acquisto_Abitazione_Type**

diagram		
namespace	urn:www.agenziaentrate.gov.it:specificheTecniche:sco:730	
children	m730:NumeroRata m730:Importo	

element **Iva_Acquisto_Abitazione_Type/NumeroRata**

diagram		
namespace	urn:www.agenziaentrate.gov.it:specificheTecniche:sco:730	
type	restriction of DatoNP_Type	
facets	Kind	Value
	pattern	[1-9]{1}[0-9]*
	enumeration	1

element Iva_Acquisto_Abitazione_Type/Importo

diagram					
namespace	urn:www.agenziaentrate.gov.it:specificheTecniche:sco:730				
type	DatoNP_Type				
facets	<table border="1"> <thead> <tr> <th>Kind</th> <th>Value</th> </tr> </thead> <tbody> <tr> <td>pattern</td> <td>[1-9]{1}[0-9]*</td> </tr> </tbody> </table>	Kind	Value	pattern	[1-9]{1}[0-9]*
Kind	Value				
pattern	[1-9]{1}[0-9]*				

complexType Lavoro_Dipendente_Type

diagram	
namespace	urn:www.agenziaentrate.gov.it:specificheTecniche:sco:730
children	m730:TipologiaReddito m730:TipoContratto m730:Reddito

element Lavoro_Dipendente_Type/TipologiaReddito

diagram																	
namespace	urn:www.agenziaentrate.gov.it:specificheTecniche:sco:730																
type	restriction of DatoN1_Type																
facets	<table border="1"> <thead> <tr> <th>Kind</th> <th>Value</th> </tr> </thead> <tbody> <tr> <td>pattern</td> <td>[1-9]</td> </tr> <tr> <td>enumeration</td> <td>1</td> </tr> <tr> <td>enumeration</td> <td>2</td> </tr> <tr> <td>enumeration</td> <td>3</td> </tr> <tr> <td>enumeration</td> <td>4</td> </tr> <tr> <td>enumeration</td> <td>5</td> </tr> <tr> <td>enumeration</td> <td>6</td> </tr> </tbody> </table>	Kind	Value	pattern	[1-9]	enumeration	1	enumeration	2	enumeration	3	enumeration	4	enumeration	5	enumeration	6
Kind	Value																
pattern	[1-9]																
enumeration	1																
enumeration	2																
enumeration	3																
enumeration	4																
enumeration	5																
enumeration	6																

element Lavoro_Dipendente_Type/TipoContratto

diagram									
namespace	urn:www.agenziaentrate.gov.it:specificheTecniche:sco:730								
type	m730:Indeterminato_Determinato_Type								
facets	<table border="1"> <thead> <tr> <th>Kind</th> <th>Value</th> </tr> </thead> <tbody> <tr> <td>pattern</td> <td>[1-9]</td> </tr> <tr> <td>enumeration</td> <td>1</td> </tr> <tr> <td>enumeration</td> <td>2</td> </tr> </tbody> </table>	Kind	Value	pattern	[1-9]	enumeration	1	enumeration	2
Kind	Value								
pattern	[1-9]								
enumeration	1								
enumeration	2								

element **Lavoro_Dipendente_Type/Reddito**

diagram	
namespace	urn:www.agenziaentrate.gov.it:specificheTecniche:sco:730
type	DatoNP_Type
facets	Kind Value pattern [1-9]{1}[0-9]*

complexType **Misura_Acconti_Type**

diagram	
namespace	urn:www.agenziaentrate.gov.it:specificheTecniche:sco:730
children	m730:IrpefMisuralInferiore m730:AddComunaleMisuralInferiore m730:CedolareSeccaMisuralInferiore m730:NumeroRate

element **Misura_Acconti_Type/IrpefMisuralInferiore**

diagram	
namespace	urn:www.agenziaentrate.gov.it:specificheTecniche:sco:730
type	m730:Casella_Acconto_Type
children	m730:Casella m730:ImportoMisuralInferiore

element **Misura_Acconti_Type/AddComunaleMisuralInferiore**

diagram	
namespace	urn:www.agenziaentrate.gov.it:specificheTecniche:sco:730

type	m730:Casella_Aconto_Type
children	m730:Casella m730:ImportoMisuralInferiore

element **Misura_Aconti_Type/CedolareSeccaMisuralInferiore**

diagram	
namespace	urn:www.agenziaentrate.gov.it:specificheTecniche:sco:730
type	m730:Casella_Aconto_Type
children	m730:Casella m730:ImportoMisuralInferiore

element **Misura_Aconti_Type/NumeroRate**

diagram																	
namespace	urn:www.agenziaentrate.gov.it:specificheTecniche:sco:730																
type	restriction of DatoN1_Type																
facets	<table border="1"> <thead> <tr> <th>Kind</th> <th>Value</th> </tr> </thead> <tbody> <tr> <td>pattern</td> <td>[1-9]</td> </tr> <tr> <td>enumeration</td> <td>2</td> </tr> <tr> <td>enumeration</td> <td>3</td> </tr> <tr> <td>enumeration</td> <td>4</td> </tr> <tr> <td>enumeration</td> <td>5</td> </tr> <tr> <td>enumeration</td> <td>6</td> </tr> <tr> <td>enumeration</td> <td>7</td> </tr> </tbody> </table>	Kind	Value	pattern	[1-9]	enumeration	2	enumeration	3	enumeration	4	enumeration	5	enumeration	6	enumeration	7
Kind	Value																
pattern	[1-9]																
enumeration	2																
enumeration	3																
enumeration	4																
enumeration	5																
enumeration	6																
enumeration	7																

complexType **Mod730_Integrativo_Type**

diagram	
namespace	urn:www.agenziaentrate.gov.it:specificheTecniche:sco:730
children	m730:ImportiRimborsare m730:ImportoRimborsato m730:ImportoRimborsatoAgenzia

element **Mod730_Integrativo_Type/ImportiRimborsare**

diagram	
namespace	urn:www.agenziaentrate.gov.it:specificheTecniche:sco:730
type	m730:Importi_Rimborsare_730-4_Integrativo_Type
children	m730:IrpefRimborsare m730:AddRegRimborsare m730:AddComRimborsare m730:CedolareRimborsare m730:TassazioneSepRimborsare m730:PremiRisultatoRimborsare m730:ContributoSolidarieta

element **Mod730_Integrativo_Type/ImportoRimborsato**

diagram					
namespace	urn:www.agenziaentrate.gov.it:specificheTecniche:sco:730				
type	DatoNP_Type				
facets	<table border="1"> <thead> <tr> <th>Kind</th> <th>Value</th> </tr> </thead> <tbody> <tr> <td>pattern</td> <td>[1-9]{1}[0-9]*</td> </tr> </tbody> </table>	Kind	Value	pattern	[1-9]{1}[0-9]*
Kind	Value				
pattern	[1-9]{1}[0-9]*				

element **Mod730_Integrativo_Type/ImportoRimborsatoAgenzia**

diagram					
namespace	urn:www.agenziaentrate.gov.it:specificheTecniche:sco:730				
type	DatoNP_Type				
facets	<table border="1"> <thead> <tr> <th>Kind</th> <th>Value</th> </tr> </thead> <tbody> <tr> <td>pattern</td> <td>[1-9]{1}[0-9]*</td> </tr> </tbody> </table>	Kind	Value	pattern	[1-9]{1}[0-9]*
Kind	Value				
pattern	[1-9]{1}[0-9]*				

complexType **Modulo_Altri_Reddi_Type**

diagram	
namespace	urn:www.agenziaentrate.gov.it:specificheTecniche:sco:730
children	m730:RedditiDiCapitale m730:RedditiTassazioneSeparata

element **Modulo_Altri_Reddi_Type/RedditiDiCapitale**

diagram	
namespace	urn:www.agenziaentrate.gov.it:specificheTecniche:sco:730
type	m730:Redditi_Capitale_Type
children	m730:Utili m730:AltriRedditiDiCapitale m730:LavoroAutonomo m730:RedditiDiversi m730:RedditiDiversiDetraz

element **Modulo_Altri_Reddi_Type/RedditiTassazioneSeparata**

diagram	
namespace	urn:www.agenziaentrate.gov.it:specificheTecniche:sco:730
type	m730:Redditi_Tassazione_Separata_Type
children	m730:RedditiErede m730:ImposteRimborsate

complexType **Modulo_Anotazioni_Type**

diagram	
namespace	urn:www.agenziaentrate.gov.it:specificheTecniche:sco:730
children	m730:Annotazione

element **Modulo_Anotazioni_Type/Annotazione**

diagram	
namespace	urn:www.agenziaentrate.gov.it:specificheTecniche:sco:730
type	m730:Annotazione_Type
children	m730:Codice m730:RigoQuadro m730:ModuloQuadro m730:Importo

complexType **Modulo_Comunicazione_Type**

diagram	
namespace	urn:www.agenziaentrate.gov.it:specificheTecniche:sco:730
children	m730:DatiCondominio m730:DatiCatastali m730:DomandaAccatastamento m730:DatiFornitore

element **Modulo_Communicazione_Type/DatiCondominio**

diagram	<p>The diagram shows a box labeled 'm730:DatiCondominio' connected to a central connector box. This connector box is linked to a larger dashed box labeled 'm730:Dati_Condominio_Type'. Inside this dashed box, there are two sub-elements: 'm730:CodiceFiscale' and 'm730:Denominazione'.</p>
namespace	urn:www.agenziaentrate.gov.it:specificheTecniche:sco:730
type	m730:Dati_Condominio_Type
children	m730:CodiceFiscale m730:Denominazione

element **Modulo_Communicazione_Type/DatiCatastali**

diagram	<p>The diagram shows a dashed box labeled 'm730:DatiCatastali' connected to a central connector box. This connector box is linked to a larger dashed box labeled 'm730:Dati_Catastali_Type'. Inside this dashed box, there are six sub-elements: 'm730:CodiceComune', 'm730:TerreniUrbano', 'm730:SezioneUrbanaComuneCatastale', 'm730:Foglio', 'm730:Particella', and 'm730:Subalterno'.</p>
namespace	urn:www.agenziaentrate.gov.it:specificheTecniche:sco:730
type	m730:Dati_Catastali_Type
children	m730:CodiceComune m730:TerreniUrbano m730:SezioneUrbanaComuneCatastale m730:Foglio m730:Particella m730:Subalterno

element **Modulo_Communicazione_Type/DomandaAccatastamento**

diagram	<p>The diagram shows a dashed box labeled 'm730:DomandaAccatastamento' connected to a central connector box. This connector box is linked to a larger dashed box labeled 'm730:Domanda_Accatastamento_Type'. Inside this dashed box, there are three sub-elements: 'm730:Data', 'm730:Numero', and 'm730:ProvinciaUfficio'.</p>
namespace	urn:www.agenziaentrate.gov.it:specificheTecniche:sco:730

type	m730:Domanda Accatamento Type
children	m730:Data m730:Numero m730:ProvinciaUfficio

element **Modulo_Communicazione_Type/DatiFornitore**

diagram	
namespace	urn:www.agenziaentrate.gov.it:specificheTecniche:sco:730
type	m730:Dati Fornitore Type
children	m730:CodiceFiscale m730:CognomeDenom m730:Nome m730:Sesso m730:DataNascita m730:ComuneNascita m730:ProvinciaNascita m730:ImportoAcquisti

complexType **Modulo_Crediti_Imposta_Type**

diagram	
namespace	urn:www.agenziaentrate.gov.it:specificheTecniche:sco:730
children	m730:CreditiImpostaFondiPensione m730:CreditiImpostaRedditiEsteri m730:CreditoPrimaCasaSismaAbruzzo m730:CreditoAltriSismaAbruzzo m730:CreditoNegoziazione

element **Modulo_Crediti_Imposta_Type/CreditiImpostaFondiPensione**

diagram	
namespace	urn:www.agenziaentrate.gov.it:specificheTecniche:sco:730
type	m730:Crediti_Imposta_Fondi_Pensione_Type
children	m730:AnnoAnticipazione m730:Reintegro m730:SommaReintegrata m730:CreditoAnno

element **Modulo_Crediti_Imposta_Type/CreditiImpostaRedditiEsteri**

diagram	
namespace	urn:www.agenziaentrate.gov.it:specificheTecniche:sco:730
type	m730:Crediti_Imposta_Redditi_Esteri_Type
children	m730:StatoEestero m730:Anno m730:RedditoEestero m730:ImpostaEstera m730:RedditoComplessivo m730:Imposta_Lorda m730:ImpostaNetta m730:CreditoDichiarazioniPrecedenti m730:DiCuiStatoEestero

element **Modulo_Crediti_Imposta_Type/CreditoPrimaCasaSismaAbruzzo**

diagram	
namespace	urn:www.agenziaentrate.gov.it:specificheTecniche:sco:730
type	m730:Credito_Immobile_Sisma_Abruzzo_Type
children	m730:CodiceFiscale m730:NumeroRata m730:TotaleCredito

element **Modulo_Crediti_Imposta_Type/CreditoAltriSismaAbruzzo**

diagram	
namespace	urn:www.agenziaentrate.gov.it:specificheTecniche:sco:730
type	m730:Crediti_Imposta_Altri_Sisma_Abruzzo_Type
children	m730:Impresa_Professione m730:CreditoImmobileSismaAbruzzo m730:Rateazione

element **Modulo_Crediti_Imposta_Type/CreditoNegoziazione**

diagram	
namespace	urn:www.agenziaentrate.gov.it:specificheTecniche:sco:730
type	m730:Modulo_Credito_Negoziatore_Type
children	m730:CreditoSpettante

complexType **Modulo_Credito_Negoziatore_Type**

diagram	
---------	--

namespace	urn:www.agenziaentrate.gov.it:specificheTecniche:sco:730
children	m730:CreditoSpettante

element **Modulo_Credito_Negoziatore_Type/CreditoSpettante**

diagram					
namespace	urn:www.agenziaentrate.gov.it:specificheTecniche:sco:730				
type	DatoNP_Type				
facets	<table border="1"> <thead> <tr> <th>Kind</th> <th>Value</th> </tr> </thead> <tbody> <tr> <td>pattern</td> <td>[1-9]{1}[0-9]*</td> </tr> </tbody> </table>	Kind	Value	pattern	[1-9]{1}[0-9]*
Kind	Value				
pattern	[1-9]{1}[0-9]*				

complexType **Modulo_Fabbricato_Type**

diagram	
namespace	urn:www.agenziaentrate.gov.it:specificheTecniche:sco:730
children	m730:FabbricatoOrd m730:FabbricatoAgev

element **Modulo_Fabbricato_Type/FabbricatoOrd**

<p>diagram</p>	
<p>namespace</p>	<p>urn:www.agenziaentrate.gov.it:specificheTecniche:sco:730</p>
<p>type</p>	<p>m730:Fabbricato_Ord_Type</p>
<p>children</p>	<p>m730:Rendita m730:Utilizzo m730:GiorniPossesso m730:PercPossesso m730:CodiceCanone m730:CanoneLocazione m730:CasiParticolari m730:CasellaContinuazione m730:CodiceComune m730:OpzioneCedolare m730:CasellaCasiPartimu</p>

element **Modulo_Fabbricato_Type/FabbricatoAgev**

<p>diagram</p>	
----------------	--

namespace	urn:www.agenziaentrate.gov.it:specificheTecniche:sco:730
type	m730:Fabbricato_Agev_Type
children	m730:NumeroRigoRiferimento m730:NumModuloRiferimento m730:DatiContratto m730:CasellaInf30Giorni m730:AnnoDichiarazioneIcilmu m730:StatoEmergenza

complexType **Modulo_Familiari_Type**

diagram	
namespace	urn:www.agenziaentrate.gov.it:specificheTecniche:sco:730
children	m730:Coniuge m730:PrimoFiglio m730:Familiari

element **Modulo_Familiari_Type/Coniuge**

diagram	
namespace	urn:www.agenziaentrate.gov.it:specificheTecniche:sco:730
type	m730:Dati_Coniuge_Type
children	m730:Tipo m730:CodiceFiscale m730:Mesi

element **Modulo_Familiari_Type/PrimoFiglio**

diagram	<p>The diagram shows a class m730:PrimoFiglio (dashed border) extending the class m730:Dati_Familiare_Type (yellow background, dashed border). The extension includes several elements: m730:CodiceFiscale, m730:Mesi, m730:MesiMinore, m730:PercDetraz, m730:PercDetrazCon, m730:Affidamento, and m730:Tipo. Each element is represented by a box with a small icon indicating its data type or cardinality.</p>
namespace	urn:www.agenziaentrate.gov.it:specificheTecniche:sco:730
type	extension of m730:Dati_Familiare_Type
children	m730:CodiceFiscale m730:Mesi m730:MesiMinore m730:PercDetraz m730:PercDetrazCon m730:Affidamento m730:Tipo

element **Modulo_Familiari_Type/PrimoFiglio/Tipo**

diagram	<p>The diagram shows a class m730:Tipo (solid border) which is a restriction of the DatoAN_Type.</p>								
namespace	urn:www.agenziaentrate.gov.it:specificheTecniche:sco:730								
type	restriction of DatoAN_Type								
facets	<table border="0"> <tr> <td>Kind</td> <td>Value</td> </tr> <tr> <td>pattern</td> <td>(([0-9A-Z-] &quot;){1}([0-9A-Z&amp;] ' \- \.\ / ° °\ °\(\) À É È Ì Ò Ù Û &quot; \N \+)*</td> </tr> <tr> <td>enumeration</td> <td>F</td> </tr> <tr> <td>enumeration</td> <td>D</td> </tr> </table>	Kind	Value	pattern	(([0-9A-Z-] "){1}([0-9A-Z&] ' \- \.\ / ° °\ °\(\) À É È Ì Ò Ù Û " \N \+)*	enumeration	F	enumeration	D
Kind	Value								
pattern	(([0-9A-Z-] "){1}([0-9A-Z&] ' \- \.\ / ° °\ °\(\) À É È Ì Ò Ù Û " \N \+)*								
enumeration	F								
enumeration	D								

element **Modulo_Familiari_Type/Familiari**

diagram	
namespace	urn:www.agenziaentrate.gov.it:specificheTecniche:sco:730
type	extension of m730:Dati_Familiare_Type
children	m730:CodiceFiscale m730:Mesi m730:MesiMinore m730:PercDetraz m730:PercDetrazCon m730:Affidamento m730:Tipo

element **Modulo_Familiari_Type/Familiari/Tipo**

diagram											
namespace	urn:www.agenziaentrate.gov.it:specificheTecniche:sco:730										
type	restriction of DatoAN_Type										
facets	<table border="0"> <thead> <tr> <th>Kind</th> <th>Value</th> </tr> </thead> <tbody> <tr> <td>pattern</td> <td>(([0-9A-Z-] &quot;){1}([0-9A-Z&amp;:] ' \- . \, / \^\(\ \) À É È Ì Ò Ù Û &quot; \N \+)*</td> </tr> <tr> <td>enumeration</td> <td>F</td> </tr> <tr> <td>enumeration</td> <td>D</td> </tr> <tr> <td>enumeration</td> <td>A</td> </tr> </tbody> </table>	Kind	Value	pattern	(([0-9A-Z-] "){1}([0-9A-Z&:] ' \- . \, / \^\(\ \) À É È Ì Ò Ù Û " \N \+)*	enumeration	F	enumeration	D	enumeration	A
Kind	Value										
pattern	(([0-9A-Z-] "){1}([0-9A-Z&:] ' \- . \, / \^\(\ \) À É È Ì Ò Ù Û " \N \+)*										
enumeration	F										
enumeration	D										
enumeration	A										

complexType **Modulo_Lavoro_Dip_Type**

diagram	
---------	--

namespace	urn:www.agenziaentrate.gov.it:specificheTecniche:sco:730
children	m730:LavoroDipendente m730:PremiRisultato m730:AltriRedditiAssLavDip m730:BonusIrpef

element **Modulo_Lavoro_Dip_Type/LavoroDipendente**

diagram	
namespace	urn:www.agenziaentrate.gov.it:specificheTecniche:sco:730
type	m730:Lavoro_Dipendente_Type
children	m730:TipologiaReddito m730:TipoContratto m730:Reddito

element **Modulo_Lavoro_Dip_Type/PremiRisultato**

diagram	
namespace	urn:www.agenziaentrate.gov.it:specificheTecniche:sco:730
type	m730:Premi_Risultato_Modulo_Type
children	m730:TipoLimite m730:ImportoTassazOrdinaria m730:ImportoImpostaSostitutiva m730:RitenuteImpostaSostitutiva m730:Benefit

element **Modulo_Lavoro_Dip_Type/AltriRedditiAssLavDip**

diagram	
namespace	urn:www.agenziaentrate.gov.it:specificheTecniche:sco:730
type	m730:Altri_Redditi_Ass_Lav_Type
children	m730:AssegnoDelConiuge m730:ImportoRedditoAssimilato

element **Modulo_Lavoro_Dip_Type/BonusIrpéf**

diagram	
namespace	urn:www.agenziaentrate.gov.it:specificheTecniche:sco:730
children	m730:Esenzione

element **Modulo_Lavoro_Dip_Type/BonusIrpéf/Esenzione**

diagram	
namespace	urn:www.agenziaentrate.gov.it:specificheTecniche:sco:730
type	m730:Esenzione_Bonus_Type
children	m730:TipologiaEsenzione m730:ParteRedditoEsente

complexType **Modulo_Oneri_Type**

<p>diagram</p>	
<p>namespace</p>	<p>urn:www.agenziaentrate.gov.it:specificheTecniche:sco:730</p>
<p>children</p>	<p>m730:SpeseDetrazioni m730:SpeseDeduzioni m730:InterventoRecuperoPatrimonioEdilizio m730:DatiCatastaliRecuperoPatrimonioEdilizio m730:InterventoRisparmioEnergetico m730:CanoniLocazione m730:DatiAltreDetrazioni m730:SpeseArredo m730:SpeseArredoGiovaniCoppie m730:IvaAcquistoAbitazione</p>

element **Modulo_Oneri_Type/SpeseDetrazioni**

<p>diagram</p>	
<p>namespace</p>	<p>urn:www.agenziaentrate.gov.it:specificheTecniche:sco:730</p>
<p>type</p>	<p>m730:Detrazioni Modulo_Type</p>

children	m730:VeicoliDisabili m730:AcquistoCaniGuida m730:SpeseRateizzate m730:AltreSpese m730:SpeseLeasing
----------	--

element **Modulo_Oneri_Type/SpeseDeduzioni**

diagram	
namespace	urn:www.agenziaentrate.gov.it:specificheTecniche:sco:730
type	m730:Deduzioni_Modulo_Type
children	m730:AssegnoConiuge m730:AltriOneri m730:AcquistoCostruzioneAbitLocazione

element **Modulo_Oneri_Type/InterventoRecuperoPatrimonioEdilizio**

diagram	
namespace	urn:www.agenziaentrate.gov.it:specificheTecniche:sco:730
type	m730:Intervento_Recupero_Patrimonio_Edilizio_Type
children	m730:Anno m730:Periodo m730:CodiceFiscale m730:CasellaInterventiParticolari m730:CodiceSituazioniParticolari m730:Rate10 m730:Spesa m730:NOrdineImmobile

element **Modulo_Oneri_Type/DatiCatastaliRecuperoPatrimonioEdilizio**

diagram	
namespace	urn:www.agenziaentrate.gov.it:specificheTecniche:sco:730
type	m730:Sezione Dati Catastali Recupero Patrimonio Edilizio Type
children	m730:DatiCatastaliRecuperoPatrimonioEdilizio m730:DatiRegistrazioneAccatastamentoRecuperoPatrimonio Edilizio

element **Modulo_Oneri_Type/InterventoRisparmioEnergetico**

diagram	
namespace	urn:www.agenziaentrate.gov.it:specificheTecniche:sco:730
type	m730:Intervento Risparmio Energetico Type
children	m730:TipoIntervento m730:Anno m730:Periodo2013 m730:CasiParticolari m730:RideterminazioneRate m730:RipartizioneRate m730:NumeroRata m730:Spesa

element **Modulo_Oneri_Type/CanoniLocazione**

diagram	
namespace	urn:www.agenziaentrate.gov.it:specificheTecniche:sco:730
type	m730:Detrazioni Canoni Locazione Type
children	m730:InquiliniAbitazionePrincipale m730:DipendentiTrasferiti

element **Modulo_Oneri_Type/DatiAltreDetrazioni**

diagram	
namespace	urn:www.agenziaentrate.gov.it:specificheTecniche:sco:730
type	m730:Dati Altre Detrazioni Modulo Type
children	m730:AltreDetrazioni

element **Modulo_Oneri_Type/SpeseArredo**

diagram	
namespace	urn:www.agenziaentrate.gov.it:specificheTecniche:sco:730
type	m730:Spese Arredo Type
children	m730:NumeroRata m730:Importo

element **Modulo_Oneri_Type/SpeseArredoGiovaniCoppie**

diagram	
namespace	urn:www.agenziaentrate.gov.it:specificheTecniche:sco:730
type	m730:Spese Arredo Giovani Coppie Type
children	m730:Meno35Anni m730:NumeroRata m730:Importo

element **Modulo_Oneri_Type/IvaAcquistoAbitazione**

diagram	
namespace	urn:www.agenziaentrate.gov.it:specificheTecniche:sco:730
type	m730:Iva Acquisto Abitazione Type
children	m730:NumeroRata m730:Importo

complexType **Modulo_PL_Type**

diagram	
namespace	urn:www.agenziaentrate.gov.it:specificheTecniche:sco:730
children	m730:CredImpEstero

element **Modulo_PL_Type/CredImpEstero**

diagram	
namespace	urn:www.agenziaentrate.gov.it:specificheTecniche:sco:730
type	m730:Cred_Imp_Estero_Type
children	m730:Anno m730:TotCredito m730:CreditoStato

complexType **Modulo_Terreno_Type**

diagram	
namespace	urn:www.agenziaentrate.gov.it:specificheTecniche:sco:730
children	m730:Terreno

element **Modulo_Terreno_Type/Terreno**

<p>diagram</p>	
<p>namespace</p>	<p>urn:www.agenziaentrate.gov.it:specificheTecniche:sco:730</p>
<p>type</p>	<p>m730:Terreno_Type</p>
<p>children</p>	<p>m730:RedDominicale m730:Titolo m730:RedAgrario m730:GiorniPossesso m730:PercPossesso m730:CanoneVincolistico m730:CasiParticolari m730:CasellaContinuazione m730:CasellalmuNonDovuta m730:CasellaColtivatoreDiretto</p>

complexType **Oneri_Non_Abbattuti_Type**

diagram	
namespace	urn:www.agenziaentrate.gov.it:specificheTecniche:sco:730
children	m730:DetrazSpeseAssPersonale m730:DetrazErogazBiennaleVenezia m730:DetrazErogazSpettacolo m730:DetrazErogazSettoreMusicale m730:DeduzContributiPaesiSviluppo m730:DeduzOnlus m730:DetrazOspedaleGalliera m730:PrevidenzaCompIDipPubblici m730:InteressiMutuiAgrari m730:DeduzTrust

element **Oneri_Non_Abbattuti_Type/DetrazSpeseAssPersonale**

diagram					
namespace	urn:www.agenziaentrate.gov.it:specificheTecniche:sco:730				
type	DatoNP_Type				
facets	<table border="1"> <thead> <tr> <th>Kind</th> <th>Value</th> </tr> </thead> <tbody> <tr> <td>pattern</td> <td>[1-9]{1}[0-9]*</td> </tr> </tbody> </table>	Kind	Value	pattern	[1-9]{1}[0-9]*
Kind	Value				
pattern	[1-9]{1}[0-9]*				

element **Oneri_Non_Abbattuti_Type/DetrazErogazBiennaleVenezia**

diagram					
namespace	urn:www.agenziaentrate.gov.it:specificheTecniche:sco:730				
type	DatoNP_Type				
facets	<table border="1"> <thead> <tr> <th>Kind</th> <th>Value</th> </tr> </thead> <tbody> <tr> <td>pattern</td> <td>[1-9]{1}[0-9]*</td> </tr> </tbody> </table>	Kind	Value	pattern	[1-9]{1}[0-9]*
Kind	Value				
pattern	[1-9]{1}[0-9]*				

element **Oneri_Non_Abbattuti_Type/DetrazErogazSpettacolo**

diagram	 m730:DetrazErogazSpettacolo
namespace	urn:www.agenziaentrate.gov.it:specificheTecniche:sco:730
type	DatoNP_Type
facets	Kind Value pattern [1-9]{1}[0-9]*

element **Oneri_Non_Abbattuti_Type/DetrazErogazSettoreMusicale**

diagram	 m730:DetrazErogazSettoreMus...
namespace	urn:www.agenziaentrate.gov.it:specificheTecniche:sco:730
type	DatoNP_Type
facets	Kind Value pattern [1-9]{1}[0-9]*

element **Oneri_Non_Abbattuti_Type/DeduzContributiPaesiSviluppo**

diagram	 m730:DeduzContributiPaesiSvilu...
namespace	urn:www.agenziaentrate.gov.it:specificheTecniche:sco:730
type	DatoNP_Type
facets	Kind Value pattern [1-9]{1}[0-9]*

element **Oneri_Non_Abbattuti_Type/DeduzOnlus**

diagram	 m730:DeduzOnlus
namespace	urn:www.agenziaentrate.gov.it:specificheTecniche:sco:730
type	DatoNP_Type
facets	Kind Value pattern [1-9]{1}[0-9]*

element **Oneri_Non_Abbattuti_Type/DetrazOspedaleGalliera**

diagram	 m730:DetrazOspedaleGalliera
namespace	urn:www.agenziaentrate.gov.it:specificheTecniche:sco:730
type	DatoNP_Type
facets	Kind Value pattern [1-9]{1}[0-9]*

element **Oneri_Non_Abbattuti_Type/PrevidenzaCompIDipPubblici**

diagram	
namespace	urn:www.agenziaentrate.gov.it:specificheTecniche:sco:730
type	DatoNP_Type
facets	Kind Value pattern [1-9]{1}[0-9]*

element **Oneri_Non_Abbattuti_Type/InteressiMutuiAgrari**

diagram	
namespace	urn:www.agenziaentrate.gov.it:specificheTecniche:sco:730
type	DatoNP_Type
facets	Kind Value pattern [1-9]{1}[0-9]*

element **Oneri_Non_Abbattuti_Type/DeduzTrust**

diagram	
namespace	urn:www.agenziaentrate.gov.it:specificheTecniche:sco:730
type	DatoNP_Type
facets	Kind Value pattern [1-9]{1}[0-9]*

complexType **Oneri_Type**

diagram	
namespace	urn:www.agenziaentrate.gov.it:specificheTecniche:sco:730
children	m730:PrimoModulo m730:Modulo

element **Oneri_Type/PrimoModulo**

<p>diagram</p>	
<p>namespace</p>	<p>urn:www.agenziaentrate.gov.it:specificheTecniche:sco:730</p>
<p>type</p>	<p>m730:Primo_Modulo_Oneri_Type</p>
<p>children</p>	<p>m730:SpeseDetrazioni m730:SpeseDeduzioni m730:InterventoRecuperoPatrimonioEdilizio m730:DatiCatastaliRecuperoPatrimonioEdilizio m730:InterventoRisparmioEnergetico m730:CanoniLocazione m730:DatiAltreDetrazioni m730:OneriNonAbbattuti m730:SpeseArredo m730:SpeseArredoGiovani m730:IvaAcquistoAbitazione</p>

element **Oneri_Type/Modulo**

<p>diagram</p>	
<p>namespace</p>	<p>urn:www.agenziaentrate.gov.it:specificheTecniche:sco:730</p>
<p>type</p>	<p>m730:Modulo_Oneri_Type</p>
<p>children</p>	<p>m730:SpeseDetrazioni m730:SpeseDeduzioni m730:InterventoRecuperoPatrimonioEdilizio m730:DatiCatastaliRecuperoPatrimonioEdilizio m730:InterventoRisparmioEnergetico m730:CanoniLocazione m730:DatiAltreDetrazioni m730:SpeseArredo m730:SpeseArredoGiovaniCoppie m730:IvaAcquistoAbitazione</p>

complexType **Opzione_Produttivita_Type**

<p>diagram</p>	
<p>namespace</p>	<p>urn:www.agenziaentrate.gov.it:specificheTecniche:sco:730</p>

complexType **Periodo_Di_Lavoro_Type**

<p>diagram</p>	
<p>namespace</p>	<p>urn:www.agenziaentrate.gov.it:specificheTecniche:sco:730</p>

children	m730:GiorniLavoroDipendente m730:GiorniPensione
----------	---

element **Periodo_Di_Lavoro_Type/GiorniLavoroDipendente**

diagram					
namespace	urn:www.agenziaentrate.gov.it:specificheTecniche:sco:730				
type	DatoGA_Type				
facets	<table border="1"> <tr> <td>Kind</td> <td>Value</td> </tr> <tr> <td>pattern</td> <td>[1-9]((1-9)[0-9])((12)[0-9][0-9])(3[0-5][0-9])(36[0-5])</td> </tr> </table>	Kind	Value	pattern	[1-9]((1-9)[0-9])((12)[0-9][0-9])(3[0-5][0-9])(36[0-5])
Kind	Value				
pattern	[1-9]((1-9)[0-9])((12)[0-9][0-9])(3[0-5][0-9])(36[0-5])				

element **Periodo_Di_Lavoro_Type/GiorniPensione**

diagram					
namespace	urn:www.agenziaentrate.gov.it:specificheTecniche:sco:730				
type	DatoGA_Type				
facets	<table border="1"> <tr> <td>Kind</td> <td>Value</td> </tr> <tr> <td>pattern</td> <td>[1-9]((1-9)[0-9])((12)[0-9][0-9])(3[0-5][0-9])(36[0-5])</td> </tr> </table>	Kind	Value	pattern	[1-9]((1-9)[0-9])((12)[0-9][0-9])(3[0-5][0-9])(36[0-5])
Kind	Value				
pattern	[1-9]((1-9)[0-9])((12)[0-9][0-9])(3[0-5][0-9])(36[0-5])				

complexType **Pignoramento_Type**

diagram	
namespace	urn:www.agenziaentrate.gov.it:specificheTecniche:sco:730
children	m730:TipoRedditoPignoramento m730:RitenutePignoramento

element **Pignoramento_Type/TipoRedditoPignoramento**

diagram																	
namespace	urn:www.agenziaentrate.gov.it:specificheTecniche:sco:730																
type	restriction of DatoN1_Type																
facets	<table border="1"> <tr> <td>Kind</td> <td>Value</td> </tr> <tr> <td>pattern</td> <td>[1-9]</td> </tr> <tr> <td>enumeration</td> <td>1</td> </tr> <tr> <td>enumeration</td> <td>2</td> </tr> <tr> <td>enumeration</td> <td>3</td> </tr> <tr> <td>enumeration</td> <td>4</td> </tr> <tr> <td>enumeration</td> <td>5</td> </tr> <tr> <td>enumeration</td> <td>6</td> </tr> </table>	Kind	Value	pattern	[1-9]	enumeration	1	enumeration	2	enumeration	3	enumeration	4	enumeration	5	enumeration	6
Kind	Value																
pattern	[1-9]																
enumeration	1																
enumeration	2																
enumeration	3																
enumeration	4																
enumeration	5																
enumeration	6																

element **Pignoramento_Type/RitenutePignoramento**

diagram					
namespace	urn:www.agenziaentrate.gov.it:specificheTecniche:sco:730				
type	DatoNP_Type				
facets	<table border="1"> <thead> <tr> <th>Kind</th> <th>Value</th> </tr> </thead> <tbody> <tr> <td>pattern</td> <td>[1-9]{1}[0-9]*</td> </tr> </tbody> </table>	Kind	Value	pattern	[1-9]{1}[0-9]*
Kind	Value				
pattern	[1-9]{1}[0-9]*				

complexType **Premi_Risultato_Modulo_Type**

diagram	
namespace	urn:www.agenziaentrate.gov.it:specificheTecniche:sco:730
children	m730:TipoLimite m730:ImportoTassazOrdinaria m730:ImportoImpostaSostitutiva m730:RitenuteImpostaSostitutiva m730:Benefit

element **Premi_Risultato_Modulo_Type/TipoLimite**

diagram									
namespace	urn:www.agenziaentrate.gov.it:specificheTecniche:sco:730								
type	restriction of DatoN1_Type								
facets	<table border="1"> <thead> <tr> <th>Kind</th> <th>Value</th> </tr> </thead> <tbody> <tr> <td>pattern</td> <td>[1-9]</td> </tr> <tr> <td>enumeration</td> <td>1</td> </tr> <tr> <td>enumeration</td> <td>2</td> </tr> </tbody> </table>	Kind	Value	pattern	[1-9]	enumeration	1	enumeration	2
Kind	Value								
pattern	[1-9]								
enumeration	1								
enumeration	2								

element **Premi_Risultato_Modulo_Type/ImportoTassazOrdinaria**

diagram					
namespace	urn:www.agenziaentrate.gov.it:specificheTecniche:sco:730				
type	DatoNP_Type				
facets	<table border="1"> <thead> <tr> <th>Kind</th> <th>Value</th> </tr> </thead> <tbody> <tr> <td>pattern</td> <td>[1-9]{1}[0-9]*</td> </tr> </tbody> </table>	Kind	Value	pattern	[1-9]{1}[0-9]*
Kind	Value				
pattern	[1-9]{1}[0-9]*				

element **Premi_Risultato_Modulo_Type/ImportoImpostaSostitutiva**

diagram	
namespace	urn:www.agenziaentrate.gov.it:specificheTecniche:sco:730
type	DatoNP_Type
facets	Kind Value pattern [1-9]{1}[0-9]*

element **Premi_Risultato_Modulo_Type/RitenuteImpostaSostitutiva**

diagram	
namespace	urn:www.agenziaentrate.gov.it:specificheTecniche:sco:730
type	DatoNP_Type
facets	Kind Value pattern [1-9]{1}[0-9]*

element **Premi_Risultato_Modulo_Type/Benefit**

diagram	
namespace	urn:www.agenziaentrate.gov.it:specificheTecniche:sco:730
type	DatoNP_Type
facets	Kind Value pattern [1-9]{1}[0-9]*

complexType **Premi_Risultato_Type**

diagram	
namespace	urn:www.agenziaentrate.gov.it:specificheTecniche:sco:730

type	extension of m730:Premi Risultato Modulo Type
children	m730:TipoLimite m730:ImportoTassazOrdinaria m730:ImportoImpostaSostitutiva m730:RitenuteImpostaSostitutiva m730:Benefit m730:TassazOrdinaria m730:TassazSostitutiva

element **Premi Risultato Type/TassazOrdinaria**

diagram	
namespace	urn:www.agenziaentrate.gov.it:specificheTecniche:sco:730
type	DatoCB Type
facets	Kind Value pattern [01]

element **Premi Risultato Type/TassazSostitutiva**

diagram	
namespace	urn:www.agenziaentrate.gov.it:specificheTecniche:sco:730
type	DatoCB Type
facets	Kind Value pattern [01]

complexType **Primo Modulo Acconti Ritenute Type**

diagram	
namespace	urn:www.agenziaentrate.gov.it:specificheTecniche:sco:730
children	m730:Accontilrpef m730:AltreRitenute m730:Eccedenze m730:EccedenzeOltreAnno m730:RitenuteAccontiSospesi m730:MisuraAcconti m730:EsenzioneAddComunale m730:Dati730Integrativo m730:AccontiAltriDati

element **Primo Modulo Acconti Ritenute Type/Accontilrpef**

diagram	
namespace	urn:www.agenziaentrate.gov.it:specificheTecniche:sco:730
type	m730:Acconti Irpef Anno Imposta Type
children	m730:PrimaRataAccontolrpef m730:SecondaRataAccontolrpef m730:AccontoAddComunale m730:AccontoAddComunaleF24 m730:PrimaRataAccontoCedolare m730:SecondaRataAccontoCedo...

element **Primo Modulo Acconti Ritenute Type/AltreRitenute**

diagram	
namespace	urn:www.agenziaentrate.gov.it:specificheTecniche:sco:730
type	m730:Altre Ritenute Type
children	m730:Codice m730:AltreRitenuteIrpef m730:AddizionaleRegionale m730:AddizionaleComunale m730:AddRegionaleIrpefAttivitaSport m730:AddComunaleIrpefAttivitaSport m730:IrpefLavoriSocialmenteUtili m730:AddRegionaleIrpefLavoriSoc Utili

element **Primo_Modulo_Acconti_Ritenute_Type/Eccedenze**

<p>diagram</p>	
<p>namespace</p>	<p>urn:www.agenziaentrate.gov.it:specificheTecniche:sco:730</p>
<p>type</p>	<p>m730:Eccedenze_Type</p>
<p>children</p>	<p>m730:Irpef m730:IrpefCompF24 m730:SostitutivaQuadroRT m730:SostitutivaQuadroRTcompF24 m730:CedolareSecca m730:CedolareSeccaCompF24 m730:CodiceRegione m730:AddRegionaleIrpef m730:AddRegionaleIrpefCompF24 m730:CodiceCatastaleComune m730:AddComunaleIrpef m730:AddComunaleIrpefF24</p>

element **Primo_Modulo_Acconti_Ritenute_Type/EccedenzeOltreAnno**

<p>diagram</p>	
<p>namespace</p>	<p>urn:www.agenziaentrate.gov.it:specificheTecniche:sco:730</p>
<p>type</p>	<p>m730:Eccedenze Oltre Anno Type</p>
<p>children</p>	<p>m730:Anno m730:Irpef m730:SostitutivaQuadroRT m730:CedolareSecca m730:CodiceRegione m730:AddRegionaleIrpef m730:CodiceCatastaleComune m730:AddComunaleIrpef m730:ImpostaSostitutiva</p>

element **Primo_Modulo_Acconti_Ritenute_Type/RitenuteAccontiSospesi**

<p>diagram</p>	
<p>namespace</p>	<p>urn:www.agenziaentrate.gov.it:specificheTecniche:sco:730</p>
<p>type</p>	<p>m730:Ritenute Acconti Sospesi Type</p>

children	m730:CodiceEvento m730:Irpef m730:AddRegionaleIrpef m730:AddComunaleIrpef m730:SostitutivaPremi m730:CedolareSecca m730:ContribSolidarieta
----------	---

element **Primo_Modulo_Acconti_Ritenute_Type/MisuraAcconti**

diagram	
namespace	urn:www.agenziaentrate.gov.it:specificheTecniche:sco:730
type	m730:Misura_Acconti_Type
children	m730:IrpefMisuralInferiore m730:AddComunaleMisuralInferiore m730:CedolareSeccaMisuralInferiore m730:NumeroRate

element **Primo_Modulo_Acconti_Ritenute_Type/EsenzioneAddComunale**

diagram	
namespace	urn:www.agenziaentrate.gov.it:specificheTecniche:sco:730
type	m730:Esenzione_Add_Comunale_Type
children	m730:SogliaEsenzioneSaldo m730:SogliaEsenzioneAcconto

element **Primo_Modulo_Acconti_Ritenute_Type/Dati730Integrativo**

diagram	
namespace	urn:www.agenziaentrate.gov.it:specificheTecniche:sco:730
type	m730:Dati_730_Integrativo_Type

children	m730:Rimborso m730:Credito
----------	--

element **Primo_Modulo_Acconti_Ritenute_Type/AccontiAltriDati**

diagram	
namespace	urn:www.agenziaentrate.gov.it:specificheTecniche:sco:730
type	m730:Acconti_Altri_Dati_Type
children	m730:IncapientiDetrazioneFigli m730:IncapientiDetrazioneLocazione m730:RestituzioneBonusFiscale m730:RestituzioneBonusStraordinario m730:Pignoramento

complexType **Primo_Modulo_Crediti_Imposta_Type**

diagram	
namespace	urn:www.agenziaentrate.gov.it:specificheTecniche:sco:730

children	m730:CreditImpostaFabbricati m730:CreditImpostaFondiPensione m730:CreditImpostaRedditiEsteri m730:CreditoPrimaCasaSismaAbruzzo m730:CreditoAltriSismaAbruzzo m730:CreditoIncrementoOccupazione m730:CreditoImpostaMediazioni m730:CreditoErogazioniCultura m730:CreditoNegoziazione m730:CreditoErogazioniScuola m730:CreditoVideosorveglianza
----------	---

element **Primo_Modulo_Crediti_Imposta_Type/CreditImpostaFabbricati**

diagram	
namespace	urn:www.agenziaentrate.gov.it:specificheTecniche:sco:730
type	m730:Crediti_Imposta_Fabbricati_Type
children	m730:ResiduoFabbricati m730:CanoniLocazioneNonPercepiti

element **Primo_Modulo_Crediti_Imposta_Type/CreditImpostaFondiPensione**

diagram	
namespace	urn:www.agenziaentrate.gov.it:specificheTecniche:sco:730
type	extension of m730:Crediti_Imposta_Fondi_Pensione_Type
children	m730:AnnoAnticipazione m730:Reintegro m730:SommaReintegrata m730:CreditoAnno m730:ResiduoPrecedenteDichiarazione m730:DiCuiCompensatoF24

element **Primo_Modulo_Crediti_Imposta_Type/CreditImpostaFondiPensione/ResiduoPrecedenteDichiarazione**

diagram	
namespace	urn:www.agenziaentrate.gov.it:specificheTecniche:sco:730

type	DatoNP_Type
facets	Kind Value pattern [1-9]{1}[0-9]*

element **Primo Modulo_Crediti Imposta_Type/CreditImpostaFondiPensione/DiCuiCompensatoF24**

diagram	
namespace	urn:www.agenziaentrate.gov.it:specificheTecniche:sco:730
type	DatoNP_Type
facets	Kind Value pattern [1-9]{1}[0-9]*

element **Primo Modulo_Crediti Imposta_Type/CreditImpostaRedditiEsteri**

diagram	
namespace	urn:www.agenziaentrate.gov.it:specificheTecniche:sco:730
type	m730:Crediti Imposta Redditi Esteri Type
children	m730:StatoEstero m730:Anno m730:RedditoEstero m730:ImpostaEsteri m730:RedditoComplessivo m730:Imposta_Lorda m730:ImpostaNetta m730:CreditoDichiarazioniPrecedenti m730:DiCuiStatoEstero

element **Primo_Modulo_Crediti_Imposta_Type/CreditoPrimaCasaSismaAbruzzo**

diagram	
namespace	urn:www.agenziaentrate.gov.it:specificheTecniche:sco:730
type	extension of m730:Credito_Immobile_Sisma_Abruzzo_Type
children	m730:CodiceFiscale m730:NumeroRata m730:TotaleCredito m730:ResiduoPrecedenteDichiarazione

element **Primo_Modulo_Crediti_Imposta_Type/CreditoPrimaCasaSismaAbruzzo/ResiduoPrecedenteDichiarazione**

diagram					
namespace	urn:www.agenziaentrate.gov.it:specificheTecniche:sco:730				
type	DatoNP_Type				
facets	<table border="1"> <thead> <tr> <th>Kind</th> <th>Value</th> </tr> </thead> <tbody> <tr> <td>pattern</td> <td>[1-9]{1}[0-9]*</td> </tr> </tbody> </table>	Kind	Value	pattern	[1-9]{1}[0-9]*
Kind	Value				
pattern	[1-9]{1}[0-9]*				

element **Primo_Modulo_Crediti_Imposta_Type/CreditoAltriSismaAbruzzo**

diagram	
namespace	urn:www.agenziaentrate.gov.it:specificheTecniche:sco:730
type	m730:Crediti_Imposta_Altri_Sisma_Abruzzo_Type
children	m730:Impresa_Professione m730:CreditoImmobileSismaAbruzzo m730:Rateazione

element **Primo_Modulo_Crediti_Imposta_Type/CreditoIncrementoOccupazione**

diagram	
namespace	urn:www.agenziaentrate.gov.it:specificheTecniche:sco:730
type	m730:Credito_Incremento_Occupazione_Type
children	m730:ResiduoPrecedenteDichiarazione m730:DiCuiCompensatoF24

element **Primo_Modulo_Crediti_Imposta_Type/CreditoImpostaMediazioni**

diagram	
namespace	urn:www.agenziaentrate.gov.it:specificheTecniche:sco:730
type	m730:Residuo_Credito_Compens_AnnoImposta_Type
children	m730:CreditoAnno m730:DiCuiCompensatoF24

element **Primo_Modulo_Crediti_Imposta_Type/CreditoErogazioniCultura**

diagram	
namespace	urn:www.agenziaentrate.gov.it:specificheTecniche:sco:730
type	m730:Credito_Erogazioni_Cultura_Type
children	m730:SpesaAnno m730:ResiduoAnnoPrec m730:RataAnnoPrec m730:RataDueAnniPrec

element **Primo_Modulo_Crediti_Imposta_Type/CreditoNegoziazione**

diagram	
namespace	urn:www.agenziaentrate.gov.it:specificheTecniche:sco:730
type	m730:Credito_Negoziatore_Type
children	m730:CreditoSpettante m730:ResiduoAnnoPrec m730:DiCuiCompensatoF24

element **Primo_Modulo_Crediti_Imposta_Type/CreditoErogazioniScuola**

diagram	
namespace	urn:www.agenziaentrate.gov.it:specificheTecniche:sco:730
type	m730:Credito_Erogazioni_Scuola_Type
children	m730:SpesaAnno

element **Primo_Modulo_Crediti_Imposta_Type/CreditoVideosorveglianza**

diagram	
namespace	urn:www.agenziaentrate.gov.it:specificheTecniche:sco:730
type	m730:Credito_Videosorveglianza_Type
children	m730:CreditoSpettante m730:DiCuiCompensatoF24

complexType **Primo_Modulo_Familiari_Type**

diagram	
namespace	urn:www.agenziaentrate.gov.it:specificheTecniche:sco:730
type	extension of m730:Modulo_Familiari_Type
children	m730:Coniuge m730:PrimoFiglio m730:Familiari m730:PercUlteriore m730:FigliAffidoPread

element **Primo_Modulo_Familiari_Type/PercUlteriore**

diagram					
namespace	urn:www.agenziaentrate.gov.it:specificheTecniche:sco:730				
type	DatoPC_Type				
facets	<table border="1"> <thead> <tr> <th>Kind</th> <th>Value</th> </tr> </thead> <tbody> <tr> <td>pattern</td> <td>[0-9]?[0-9](,\d{1,3})? 100,0{1,3}?</td> </tr> </tbody> </table>	Kind	Value	pattern	[0-9]?[0-9](,\d{1,3})? 100,0{1,3}?
Kind	Value				
pattern	[0-9]?[0-9](,\d{1,3})? 100,0{1,3}?				

element **Primo_Modulo_Familiari_Type/FigliAffidoPread**

diagram					
namespace	urn:www.agenziaentrate.gov.it:specificheTecniche:sco:730				
type	DatoNP_Type				
facets	<table border="1"> <thead> <tr> <th>Kind</th> <th>Value</th> </tr> </thead> <tbody> <tr> <td>pattern</td> <td>[1-9]{1}[0-9]*</td> </tr> </tbody> </table>	Kind	Value	pattern	[1-9]{1}[0-9]*
Kind	Value				
pattern	[1-9]{1}[0-9]*				

complexType **Primo_Modulo_Lavoro_Dip_Type**

<p>diagram</p>	
<p>namespace</p>	<p>urn:www.agenziaentrate.gov.it:specificheTecniche:sco:730</p>
<p>children</p>	<p>m730:LavoroDipendente m730:PremiRisultato m730:PeriodoLavoro m730:AltriRedditiAssLavDip m730:RitenuteLavoroDipendente m730:BonusIrpef m730:RedditoAlNettoContribPensioni m730:ContribSolidarietaTrattenuato m730:CasellaCasiParticolari</p>

element **Primo_Modulo_Lavoro_Dip_Type/LavoroDipendente**

<p>diagram</p>	
<p>namespace</p>	<p>urn:www.agenziaentrate.gov.it:specificheTecniche:sco:730</p>
<p>type</p>	<p>m730:Lavoro_Dipendente_Type</p>
<p>children</p>	<p>m730:TipologiaReddito m730:TipoContratto m730:Reddito</p>

element **Primo_Modulo_Lavoro_Dip_Type/PremiRisultato**

diagram	
namespace	urn:www.agenziaentrate.gov.it:specificheTecniche:sco:730
type	m730:Premi_Risultato_Type
children	m730:TipoLimite m730:ImportoTassazOrdinaria m730:ImportoImpostaSostitutiva m730:RitenuteImpostaSostitutiva m730:Benefit m730:TassazOrdinaria m730:TassazSostitutiva

element **Primo_Modulo_Lavoro_Dip_Type/PeriodoLavoro**

diagram	
namespace	urn:www.agenziaentrate.gov.it:specificheTecniche:sco:730
type	m730:Periodo_Di_Lavoro_Type
children	m730:GiorniLavoroDipendente m730:GiorniPensione

element **Primo_Modulo_Lavoro_Dip_Type/AltriRedditiAssLavDip**

diagram	
namespace	urn:www.agenziaentrate.gov.it:specificheTecniche:sco:730

type	m730:Altri Redditi Ass Lav Type
children	m730:AssegnoDelConiuge m730:ImportoRedditoAssimilato

element **Primo Modulo Lavoro Dip Type/RitenuteLavoroDipendente**

diagram	
namespace	urn:www.agenziaentrate.gov.it:specificheTecniche:sco:730
type	m730:Ritenute Lavoro Dip Type
children	m730:Ritlrpef m730:RitAddRegionale m730:RitAccAddComunale m730:RitSaldoAddComunale m730:RitAccAddComAnnoPres

element **Primo Modulo Lavoro Dip Type/Bonuslrpef**

diagram	
namespace	urn:www.agenziaentrate.gov.it:specificheTecniche:sco:730
type	m730:Bonus_Irpel_Type
children	m730:CodiceBonus m730:BonusErogato m730:Esenzione m730:QuotaTfr

element **Primo Modulo Lavoro Dip Type/RedditoAlNettoContribPensioni**

diagram	
namespace	urn:www.agenziaentrate.gov.it:specificheTecniche:sco:730

type	DatoNP_Type
facets	Kind Value pattern [1-9]{1}[0-9]*

element **Primo_Modulo_Lavoro_Dip_Type/ContribSolidarietaTrattenuto**

diagram	
namespace	urn:www.agenziaentrate.gov.it:specificheTecniche:sco:730
type	DatoNP_Type
facets	Kind Value pattern [1-9]{1}[0-9]*

element **Primo_Modulo_Lavoro_Dip_Type/CasellaCasiParticolari**

diagram	
namespace	urn:www.agenziaentrate.gov.it:specificheTecniche:sco:730
type	restriction of DatoN1_Type
facets	Kind Value pattern [1-9] enumeration 1 enumeration 2 enumeration 4 enumeration 5

complexType **Primo_Modulo_Oneri_Type**

<p>diagram</p>	
<p>namespace</p>	<p>urn:www.agenziaentrate.gov.it:specificheTecniche:sco:730</p>
<p>children</p>	<p>m730:SpeseDetrazioni m730:SpeseDeduzioni m730:InterventoRecuperoPatrimonioEdilizio m730:DatiCatastaliRecuperoPatrimonioEdilizio m730:InterventoRisparmioEnergetico m730:CanoniLocazione m730:DatiAltreDetrazioni m730:OneriNonAbbattuti m730:SpeseArredo m730:SpeseArredoGiovani m730:IvaAcquistoAbitazione</p>

element **Primo_Modulo_Oneri_Type/SpeseDetrazioni**

<p>diagram</p>	<p>The diagram illustrates the structure of the m730:SpeseDetrazioni element. It is composed of a m730:Detrazioni_Type container and several sub-elements. The sub-elements are:</p> <ul style="list-style-type: none"> m730:CasellaRateazione m730:SpeseDeterminatePatologie m730:Spese Sanitarie m730:SpeseFamNonACarico m730:Spese SanitarieDisabili m730:VeicoliDisabili (+) m730:AcquistoCaniGuida (+) m730:SpeseRateizzate (+) m730:MutuiAbPrincipale m730:Altre Spese (+) m730:SpeseLeasing (+) <p>The m730:Altre Spese element is associated with a cardinality of 0..3. The m730:Detrazioni_Type container is highlighted in yellow.</p>
<p>namespace</p>	<p>urn:www.agenziaentrate.gov.it:specificheTecniche:sco:730</p>
<p>type</p>	<p>m730:Detrazioni_Type</p>
<p>children</p>	<p>m730:CasellaRateazione m730:SpeseDeterminatePatologie m730:SpeseSanitarie m730:SpeseFamNonACarico m730:SpeseSanitarieDisabili m730:VeicoliDisabili m730:AcquistoCaniGuida m730:SpeseRateizzate m730:MutuiAbPrincipale m730:AltreSpese m730:SpeseLeasing</p>

element **Primo_Modulo_Oneri_Type/SpeseDeduzioni**

<p>diagram</p>	
<p>namespace</p>	<p>urn:www.agenziaentrate.gov.it:specificheTecniche:sco:730</p>
<p>type</p>	<p>m730:Deduzioni_Type</p>
<p>children</p>	<p>m730:ContributiPrevAss m730:AssegnoConiuge m730:ContributiColf m730:ErogazionilstituzioniReligiose m730:SpesePortatoriHandicap m730:AltriOneri m730:DeducibilitaOrdinaria m730:LavoratoriPrimaOccupazione m730:FondiInSquilibrioFinanziario m730:FamiliariACarico m730:FondoPensioneDipendentiPubblici m730:AcquistoCostruzioneAbitLocazione m730:RestituzioneSomme</p>

element **Primo_Modulo_Oneri_Type/InterventoRecuperoPatrimonioEdilizio**

diagram	
namespace	urn:www.agenziaentrate.gov.it:specificheTecniche:sco:730
type	m730:Intervento Recupero Patrimonio Edilizio Type
children	m730:Anno m730:Periodo m730:CodiceFiscale m730:CasellaInterventiParticolari m730:CodiceSituazioniParticolari m730:Rate10 m730:Spesa m730:NOrdineImmobile

element **Primo_Modulo_Oneri_Type/DatiCatastaliRecuperoPatrimonioEdilizio**

diagram	
namespace	urn:www.agenziaentrate.gov.it:specificheTecniche:sco:730
type	m730:Sezione Dati Catastali Recupero Patrimonio Edilizio Type
children	m730:DatiCatastaliRecuperoPatrimonioEdilizio m730:DatiRegistrazioneAccatastamentoRecuperoPatrimonio Edilizio

element **Primo_Modulo_Oneri_Type/InterventoRisparmioEnergico**

<p>diagram</p>	
<p>namespace</p>	<p>urn:www.agenziaentrate.gov.it:specificheTecniche:sco:730</p>
<p>type</p>	<p>m730:Intervento Risparmio Energetico Type</p>
<p>children</p>	<p>m730:TipoIntervento m730:Anno m730:Periodo2013 m730:CasiParticolari m730:RideterminazioneRate m730:RipartizioneRate m730:NumeroRata m730:Spesa</p>

element **Primo_Modulo_Oneri_Type/CanoniLocazione**

<p>diagram</p>	
<p>namespace</p>	<p>urn:www.agenziaentrate.gov.it:specificheTecniche:sco:730</p>
<p>type</p>	<p>m730:Detrazioni Canoni Locazione Type</p>
<p>children</p>	<p>m730:InquiliniAbitazionePrincipale m730:DipendentiTrasferiti</p>

element **Primo_Modulo_Oneri_Type/DatiAltreDetrazioni**

diagram	
namespace	urn:www.agenziaentrate.gov.it:specificheTecniche:sco:730
type	m730:Dati_Altre_Detrazioni_Type
children	m730:SpeseCaniGuida m730:AffittoTerreniAgricoliGiovani m730:AltreDetrazioni

element **Primo_Modulo_Oneri_Type/OneriNonAbbattuti**

diagram	
namespace	urn:www.agenziaentrate.gov.it:specificheTecniche:sco:730
type	m730:Oneri Non Abbattuti_Type
children	m730:DetrazSpeseAssPersonale m730:DetrazErogazBiennaleVenezia m730:DetrazErogazSpettacolo m730:DetrazErogazSettoreMusicale m730:DeduzContributiPaesiSviluppo m730:DeduzOnlus m730:DetrazOspedaleGalliera m730:PrevidenzaCompIDipPubblici m730:InteressiMutuiAgrari m730:DeduzTrust

element **Primo_Modulo_Oneri_Type/SpeseArredo**

diagram	<p>The diagram shows a class <code>m730:SpeseArredo</code> with a multiplicity of <code>0..2</code> connected to a class <code>m730:Spese_Arredo_Type</code>. The <code>m730:Spese_Arredo_Type</code> class contains two attributes: <code>m730:NumeroRata</code> and <code>m730:Importo</code>.</p>
namespace	urn:www.agenziaentrate.gov.it:specificheTecniche:sco:730
type	m730:Spese_Arredo_Type
children	m730:NumeroRata m730:Importo

element **Primo_Modulo_Oneri_Type/SpeseArredoGiovani**

diagram	<p>The diagram shows a class <code>m730:SpeseArredoGiovani</code> connected to a class <code>m730:Spese_Arredo_Giovani_Coppie_Type</code>. The <code>m730:Spese_Arredo_Giovani_Coppie_Type</code> class contains three attributes: <code>m730:Meno35Anni</code>, <code>m730:NumeroRata</code>, and <code>m730:Importo</code>.</p>
namespace	urn:www.agenziaentrate.gov.it:specificheTecniche:sco:730
type	m730:Spese_Arredo_Giovani_Coppie_Type
children	m730:Meno35Anni m730:NumeroRata m730:Importo

element **Primo_Modulo_Oneri_Type/IvaAcquistoAbitazione**

diagram	<p>The diagram shows a class <code>m730:IvaAcquistoAbitazione</code> connected to a class <code>m730:Iva_Acquisto_Abitazione_Type</code>. The <code>m730:Iva_Acquisto_Abitazione_Type</code> class contains two attributes: <code>m730:NumeroRata</code> and <code>m730:Importo</code>.</p>
namespace	urn:www.agenziaentrate.gov.it:specificheTecniche:sco:730
type	m730:Iva_Acquisto_Abitazione_Type
children	m730:NumeroRata m730:Importo

complexType **Primo_Modulo_PL_Type**

diagram	
namespace	urn:www.agenziaentrate.gov.it:specificheTecniche:sco:730
children	m730:Prospetto m730:ProspettoRideterminato

element **Primo_Modulo_PL_Type/Prospetto**

diagram	
namespace	urn:www.agenziaentrate.gov.it:specificheTecniche:sco:730
type	extension of m730:Prospetto_Type
children	m730:RiepilogoRedditi m730:ImpostaLorda m730:DetrazioniCrediti m730:ImpostaNetta m730:Addizionali m730:CedolareSecca m730:ContributoSolidarieta m730:LiquidazioneImposte m730:AltriDati m730:CredImpEestero m730:DatiCreditiF24

element **Primo_Modulo_PL_Type/Prospetto/Addizionali**

<p>diagram</p>	
<p>namespace</p>	<p>urn:www.agenziaentrate.gov.it:specificheTecniche:sco:730</p>
<p>type</p>	<p>m730:Addizionali_Type</p>
<p>children</p>	<p>m730:Imponibile m730:AddRegDovuta m730:AddRegCertif m730:EccedenzaAddReg m730:AddComDovuta m730:AddComCertif m730:EccedenzaAddCom m730:AccontoAddCom m730:AccontoAddComCertif</p>

element **Primo_Modulo_PL_Type/Prospetto/CedolareSecca**

<p>diagram</p>	
<p>namespace</p>	<p>urn:www.agenziaentrate.gov.it:specificheTecniche:sco:730</p>
<p>type</p>	<p>m730:Cedolare_Secca_Type</p>
<p>children</p>	<p>m730:CedolareDovuta m730:EccedenzaCedolareSecca m730:AccontoCedolare</p>

element **Primo_Modulo_PL_Type/Prospetto/ContributoSolidarieta**

diagram	<pre> classDiagram class m730_ContributoSolidarieta class m730_Contributo_Solidarieta_Type { m730:ImponibileContributo m730:ContributoDovuto m730:ContributoCertificaz } m730_ContributoSolidarieta < -- m730_Contributo_Solidarieta_Type </pre>
namespace	urn:www.agenziaentrate.gov.it:specificheTecniche:sco:730
type	m730:Contributo_Solidarieta_Type
children	m730:ImponibileContributo m730:ContributoDovuto m730:ContributoCertificaz

element **Primo_Modulo_PL_Type/Prospetto/LiquidazioneImposte**

diagram	<pre> classDiagram class m730_LiquidazioneImposte class m730_EsitoIrppef class m730_EsitoAddRegionale class m730_EsitoAddComunale class m730_PrimaRataAcclrppef class m730_SecondaRataAcclrppef class m730_AccontoTassSep class m730_AccontoAddComunale class m730_ImpostaSostitutiva class m730_EsitoCedolareSecca class m730_PrimaRataAccCedolare class m730_SecondaRataAccCedolare class m730_ContribSolidarietaDebito m730_LiquidazioneImposte < -- m730_EsitoIrppef m730_LiquidazioneImposte < -- m730_EsitoAddRegionale m730_LiquidazioneImposte < -- m730_EsitoAddComunale m730_LiquidazioneImposte < -- m730_PrimaRataAcclrppef m730_LiquidazioneImposte < -- m730_SecondaRataAcclrppef m730_LiquidazioneImposte < -- m730_AccontoTassSep m730_LiquidazioneImposte < -- m730_AccontoAddComunale m730_LiquidazioneImposte < -- m730_ImpostaSostitutiva m730_LiquidazioneImposte < -- m730_EsitoCedolareSecca m730_LiquidazioneImposte < -- m730_PrimaRataAccCedolare m730_LiquidazioneImposte < -- m730_SecondaRataAccCedolare m730_LiquidazioneImposte < -- m730_ContribSolidarietaDebito </pre>
namespace	urn:www.agenziaentrate.gov.it:specificheTecniche:sco:730
children	m730:EsitoIrppef m730:EsitoAddRegionale m730:EsitoAddComunale m730:PrimaRataAcclrppef m730:SecondaRataAcclrppef m730:AccontoTassSep m730:AccontoAddComunale m730:ImpostaSostitutiva m730:EsitoCedolareSecca m730:PrimaRataAccCedolare m730:SecondaRataAccCedolare m730:ContribSolidarietaDebito

element **Primo_Modulo_PL_Type/Prospetto/LiquidazioneImposte/EsitoIrpef**

diagram	
namespace	urn:www.agenziaentrate.gov.it:specificheTecniche:sco:730
type	m730:Esito_Liquidazione_Type
children	m730:Credito m730:Debito

element **Primo_Modulo_PL_Type/Prospetto/LiquidazioneImposte/EsitoAddRegionale**

diagram	
namespace	urn:www.agenziaentrate.gov.it:specificheTecniche:sco:730
type	extension of m730:Esito_Liquidazione_Type
children	m730:Credito m730:Debito m730:CodAddReg

element **Primo_Modulo_PL_Type/Prospetto/LiquidazioneImposte/EsitoAddRegionale/CodAddReg**

diagram																																	
namespace	urn:www.agenziaentrate.gov.it:specificheTecniche:sco:730																																
type	Codice Regione Type																																
facets	<table border="1"> <thead> <tr> <th>Kind</th> <th>Value</th> </tr> </thead> <tbody> <tr> <td>pattern</td> <td>(([0-9A-Z\-\]&quot;){1}([0-9A-Z&amp;] \- \., /° √\(\) À É É Ï Ò Ù Û &quot; \ \\ / +)*</td> </tr> <tr> <td>enumeration</td> <td>1</td> </tr> <tr> <td>enumeration</td> <td>2</td> </tr> <tr> <td>enumeration</td> <td>3</td> </tr> <tr> <td>enumeration</td> <td>4</td> </tr> <tr> <td>enumeration</td> <td>5</td> </tr> <tr> <td>enumeration</td> <td>6</td> </tr> <tr> <td>enumeration</td> <td>7</td> </tr> <tr> <td>enumeration</td> <td>8</td> </tr> <tr> <td>enumeration</td> <td>9</td> </tr> <tr> <td>enumeration</td> <td>10</td> </tr> <tr> <td>enumeration</td> <td>11</td> </tr> <tr> <td>enumeration</td> <td>12</td> </tr> <tr> <td>enumeration</td> <td>13</td> </tr> <tr> <td>enumeration</td> <td>14</td> </tr> </tbody> </table>	Kind	Value	pattern	(([0-9A-Z\-\]"){1}([0-9A-Z&] \- \., /° √\(\) À É É Ï Ò Ù Û " \ \\ / +)*	enumeration	1	enumeration	2	enumeration	3	enumeration	4	enumeration	5	enumeration	6	enumeration	7	enumeration	8	enumeration	9	enumeration	10	enumeration	11	enumeration	12	enumeration	13	enumeration	14
Kind	Value																																
pattern	(([0-9A-Z\-\]"){1}([0-9A-Z&] \- \., /° √\(\) À É É Ï Ò Ù Û " \ \\ / +)*																																
enumeration	1																																
enumeration	2																																
enumeration	3																																
enumeration	4																																
enumeration	5																																
enumeration	6																																
enumeration	7																																
enumeration	8																																
enumeration	9																																
enumeration	10																																
enumeration	11																																
enumeration	12																																
enumeration	13																																
enumeration	14																																

type	DatoNP_Type
facets	Kind Value pattern [1-9]{1}[0-9]*

element **Primo_Modulo_PL_Type/Prospetto/LiquidazioneImposte/AccontoTassSep**

diagram	
namespace	urn:www.agenziaentrate.gov.it:specificheTecniche:sco:730
type	m730:Debito_Type
children	m730:NonVersare m730:ImportoDaTrattenere

element **Primo_Modulo_PL_Type/Prospetto/LiquidazioneImposte/AccontoAddComunale**

diagram	
namespace	urn:www.agenziaentrate.gov.it:specificheTecniche:sco:730
children	m730:CodiceAddComAcconto m730:AccontoAddCom

element

Primo_Modulo_PL_Type/Prospetto/LiquidazioneImposte/AccontoAddComunale/CodiceAddComAcconto

diagram	
namespace	urn:www.agenziaentrate.gov.it:specificheTecniche:sco:730
type	DatoAN_Type
facets	Kind Value pattern ([0-9A-Z- "]{1}([0-9A-Z&] ' \" \\. / ° \\¥\\(\\) À É È Ì Ò Ù Ú " \\ \\ \\ +)*

element

Primo_Modulo_PL_Type/Prospetto/LiquidazioneImposte/AccontoAddComunale/AccontoAddCom

diagram	
namespace	urn:www.agenziaentrate.gov.it:specificheTecniche:sco:730
type	DatoNP_Type

facets	Kind pattern	Value [1-9]{1}[0-9]*
--------	-----------------	-------------------------

element **Primo_Modulo_PL_Type/Prospetto/LiquidazioneImposte/ImpostaSostitutiva**

diagram	<p>The diagram shows a dashed box labeled 'm730:ImpostaSostitutiva' connected to a central octagonal connector. This connector is linked to a larger dashed box labeled 'm730:Debito_Type'. Inside this box, there are two smaller dashed boxes: 'm730:NonVersare' and 'm730:ImportoDaTrattenere'.</p>
namespace	urn:www.agenziaentrate.gov.it:specificheTecniche:sco:730
type	m730:Debito_Type
children	m730:NonVersare m730:ImportoDaTrattenere

element **Primo_Modulo_PL_Type/Prospetto/LiquidazioneImposte/EsitoCedolareSecca**

diagram	<p>The diagram shows a dashed box labeled 'm730:EsitoCedolareSecca' connected to a central octagonal connector. This connector is linked to a larger dashed box labeled 'm730:Esito_Liquidazione_Type'. Inside this box, there are two smaller boxes: 'm730:Credito' and 'm730:Debito', each with a plus sign in a small square to its right.</p>
namespace	urn:www.agenziaentrate.gov.it:specificheTecniche:sco:730
type	m730:Esito_Liquidazione_Type
children	m730:Credito m730:Debito

element **Primo_Modulo_PL_Type/Prospetto/LiquidazioneImposte/PrimaRataAccCedolare**

diagram	<p>The diagram shows a dashed box labeled 'm730:PrimaRataAccCedolare'.</p>	
namespace	urn:www.agenziaentrate.gov.it:specificheTecniche:sco:730	
type	DatoNP_Type	
facets	Kind pattern	Value [1-9]{1}[0-9]*

element **Primo_Modulo_PL_Type/Prospetto/LiquidazioneImposte/SecondaRataAccCedolare**

diagram	<p>The diagram shows a dashed box labeled 'm730:SecondaRataAccCedolare'.</p>
namespace	urn:www.agenziaentrate.gov.it:specificheTecniche:sco:730
type	DatoNP_Type

facets	Kind pattern	Value [1-9]{1}[0-9]*
--------	-----------------	-------------------------

element **Primo Modulo PL Type/Prospetto/LiquidazioneImposte/ContribSolidarietaDebito**

diagram	<pre> classDiagram class m730_ContribSolidarietaDebito class m730_Debito_Type class m730_NonVersare class m730_ImportoDaTrattenere m730_ContribSolidarietaDebito -- > m730_Debito_Type m730_NonVersare -- > m730_Debito_Type m730_ImportoDaTrattenere -- > m730_Debito_Type </pre>
namespace	urn:www.agenziaentrate.gov.it:specificheTecniche:sco:730
type	m730:Debito_Type
children	m730:NonVersare m730:ImportoDaTrattenere

element **Primo_Modulo_PL_Type/Prospetto/AltriDati**

<p>diagram</p>	
<p>namespace</p>	<p>urn:www.agenziaentrate.gov.it:specificheTecniche:sco:730</p>
<p>type</p>	<p>m730:Altri_Dati_Type</p>
<p>children</p>	<p>m730:ResiduoCreditoErogazioneCultura m730:ResiduoCreditoPrimaCasa m730:ResiduoCreditoOccupazione m730:ResiduoCreditoSisma m730:ResiduoCreditoFondiPensione m730:ResiduoCreditoMediazioni m730:TotSpeseSanitarieRateizzate m730:RedditoAgevolazioniFiscali m730:RedditoComplessivoAcconto m730:RigoDifferenzaAcconto m730:AccontiCompensatiIntern m730:RedditiFondiariniNonImponibili m730:RedditoAbitazionePrincipalePertinenze m730:ResiduoDeduzioneSommeRestituite m730:ResiduoErogazioniScuola m730:ResiduoCreditoNegoziazione m730:ResiduoCreditoVideosorveglianza m730:CreditoErogazioneCultura</p>

element **Primo_Modulo_PL_Type/Prospetto/CredImpEstero**

<p>diagram</p>	<p>The diagram illustrates the structure of the <code>m730:CredImpEstero</code> element. It is a complex type (indicated by a dashed box) that contains three child elements: <code>m730:Anno</code>, <code>m730:TotCredito</code>, and <code>m730:CreditoStato</code>. The <code>m730:CreditoStato</code> element is shown with a cardinality of <code>1..2</code>, indicating it can occur once or twice. The entire structure is contained within a yellow-shaded box labeled <code>m730:Cred_Imp_Estero_Type</code>.</p>
<p>namespace</p>	<p>urn:www.agenziaentrate.gov.it:specificheTecniche:sco:730</p>
<p>type</p>	<p>m730:Cred_Imp_Estero_Type</p>
<p>children</p>	<p>m730:Anno m730:TotCredito m730:CreditoStato</p>

element **Primo_Modulo_PL_Type/Prospetto/DatiCreditiF24**

<p>diagram</p>	
<p>namespace</p>	<p>urn:www.agenziaentrate.gov.it:specificheTecniche:sco:730</p>
<p>type</p>	<p>m730:Crediti_F24_Type</p>
<p>children</p>	<p>m730:Credlrpef m730:CredlrpefDipNoSostituto m730:CodAddReg m730:CredAddReg m730:CredAddRegDipNoSostituto m730:CodiceAddCom m730:CredAddCom m730:CredAddComDipNoSostituto m730:CredCedolare m730:CredCedolareDipNoSostituto m730:CredTassSeparDipNoSostituto m730:CredImpostaSostDipNoSostituto m730:CredSolidarietaDipNoSostituto m730:Totale m730:TotaleDipNoSostituto</p>

element **Primo_Modulo_PL_Type/ProspettoRideterminato**

diagram	
namespace	urn:www.agenziaentrate.gov.it:specificheTecniche:sco:730
type	extension of m730:Prospetto_Type
children	m730:RiepilogoRedditi m730:ImpostaLorda m730:DetrazioniCrediti m730:ImpostaNetta m730:RedditoAgevolazioniFiscali

element **Primo_Modulo_PL_Type/ProspettoRideterminato/RedditoAgevolazioniFiscali**

diagram					
namespace	urn:www.agenziaentrate.gov.it:specificheTecniche:sco:730				
type	DatoNP_Type				
facets	<table border="1"> <thead> <tr> <th>Kind</th> <th>Value</th> </tr> </thead> <tbody> <tr> <td>pattern</td> <td>[1-9]{1}[0-9]*</td> </tr> </tbody> </table>	Kind	Value	pattern	[1-9]{1}[0-9]*
Kind	Value				
pattern	[1-9]{1}[0-9]*				

complexType **Prospetto_Annotazioni_Type**

diagram	
namespace	urn:www.agenziaentrate.gov.it:specificheTecniche:sco:730
children	m730:Modulo_Annotazioni

element **Prospetto_Annotazioni_Type/Modulo_Annotazioni**

diagram	
namespace	urn:www.agenziaentrate.gov.it:specificheTecniche:sco:730

type	m730:Modulo Annotazioni Type
children	m730:Annotazione

complexType [Prospetto_Liquidazione_Type](#)

diagram	
namespace	urn:www.agenziaentrate.gov.it:specificheTecniche:sco:730
children	m730:PrimoModulo m730:Modulo

element [Prospetto_Liquidazione_Type/PrimoModulo](#)

diagram	
namespace	urn:www.agenziaentrate.gov.it:specificheTecniche:sco:730
type	m730:Primo_Modulo_PL_Type
children	m730:Prospetto m730:ProspettoRideterminato

element [Prospetto_Liquidazione_Type/Modulo](#)

diagram	
namespace	urn:www.agenziaentrate.gov.it:specificheTecniche:sco:730
type	m730:Modulo_PL_Type
children	m730:CredImpEstero

complexType **Prospetto_Type**

diagram	
namespace	urn:www.agenziaentrate.gov.it:specificheTecniche:sco:730
children	m730:RiepilogoRedditi m730:ImpostaLorda m730:DetrazioniCrediti m730:ImpostaNetta

element **Prospetto_Type/RiepilogoRedditi**

diagram	
namespace	urn:www.agenziaentrate.gov.it:specificheTecniche:sco:730
type	m730:Riepilogo_Redditi_Type
children	m730:Dominicali m730:Agrari m730:Fabbricati m730:LavDip m730:AltriRedditi m730:ImponibileCedolare m730:ImponibileCedolareOrdinario m730:ImponibileCedolareAgevolato m730:AbitazionePrincipalePertinenze

element **Prospetto_Type/ImpostaLorda**

<p>diagram</p>	<pre> classDiagram class m730:ImpostaLorda class m730:Imposta_Lorda_Type class m730:RedditoComplessivo class m730:DeduzioneAbitazPrincipale class m730:OneriDeducibili class m730:RedditoImponibile class m730:CompensiAttSport class m730:ImportoImpostaLorda m730:ImpostaLorda "1" *-- "1" m730:Imposta_Lorda_Type m730:Imposta_Lorda_Type "1" *-- "1" m730:RedditoComplessivo m730:Imposta_Lorda_Type "1" *-- "1" m730:DeduzioneAbitazPrincipale m730:Imposta_Lorda_Type "1" *-- "1" m730:OneriDeducibili m730:Imposta_Lorda_Type "1" *-- "1" m730:RedditoImponibile m730:Imposta_Lorda_Type "1" *-- "1" m730:CompensiAttSport m730:Imposta_Lorda_Type "1" *-- "1" m730:ImportoImpostaLorda </pre>
<p>namespace</p>	<p>urn:www.agenziaentrate.gov.it:specificheTecniche:sco:730</p>
<p>type</p>	<p>m730:Imposta_Lorda_Type</p>
<p>children</p>	<p>m730:RedditoComplessivo m730:DeduzioneAbitazPrincipale m730:OneriDeducibili m730:RedditoImponibile m730:CompensiAttSport m730:ImportoImpostaLorda</p>

element **Prospetto_Type/DetrazioniCrediti**

<p>diagram</p>	
<p>namespace</p>	<p>urn:www.agenziaentrate.gov.it:specificheTecniche:sco:730</p>
<p>type</p>	<p>m730:Detrazione_Crediti_Type</p>
<p>children</p>	<p>m730:DetrazioneConiuge m730:DetrazioneFigli m730:UlterioreDetrazioneFigli m730:DetrazioneFamiliari m730:DetrazioneLavDip m730:DetrazionePens m730:DetrazioneAltriRedditi m730:DetrazioneOneri</p>

[m730:DetrazioneRistrutturazione](#) [m730:DetrazioniArredolImmobili](#) [m730:DetrazioneRisparmioEnergetico](#)
[m730:DetrazioneArredoGiovaniCoppie](#) [m730:DetrazionelvaAcquistoAbitaz](#) [m730:DetrazioneLocEAgricoliGiovani](#)
[m730:AltreDetrazioni](#) [m730:CreditoPrimaCasa](#) [m730:CreditoOccupazione](#) [m730:CreditoFondiPensione](#)
[m730:CreditoMediazioni](#) [m730:CreditoNegoziazione](#) [m730:TotaleDetrazioniCrediti](#)

element **Prospetto_Type/ImpostaNetta**

<p>diagram</p>	
<p>namespace</p>	<p>urn:www.agenziaentrate.gov.it:specificheTecniche:sco:730</p>
<p>type</p>	<p>m730:Imposta_Netta_Type</p>
<p>children</p>	<p>m730:ImportoImpostaNetta m730:CredAltriSisma m730:CredAbitazSisma m730:CredImpEstere m730:CredErogCultura m730:CredErogScuola m730:CredVideosorveglianza m730:CredCanNonPerc</p>

	m730:CredDetrazIncapienti m730:Ritenute m730:Differenza m730:EccedenzaIrpef m730:AccontiVersati m730:RestituzioneBonus m730:CredRimborsatiSost m730:BonusIrpefSpettante m730:BonusIrpefRiconosciuto m730:RestituzioneBonusIrpef
--	---

complexType Quadro_I_Type

diagram	
namespace	urn:www.agenziaentrate.gov.it:specificheTecniche:sco:730
children	m730:Importo m730:Casella

element Quadro_I_Type/Importo

diagram					
namespace	urn:www.agenziaentrate.gov.it:specificheTecniche:sco:730				
type	DatoNP_Type				
facets	<table border="1"> <thead> <tr> <th>Kind</th> <th>Value</th> </tr> </thead> <tbody> <tr> <td>pattern</td> <td>[1-9]{1}[0-9]*</td> </tr> </tbody> </table>	Kind	Value	pattern	[1-9]{1}[0-9]*
Kind	Value				
pattern	[1-9]{1}[0-9]*				

element Quadro_I_Type/Casella

diagram					
namespace	urn:www.agenziaentrate.gov.it:specificheTecniche:sco:730				
type	DatoCB_Type				
facets	<table border="1"> <thead> <tr> <th>Kind</th> <th>Value</th> </tr> </thead> <tbody> <tr> <td>pattern</td> <td>[01]</td> </tr> </tbody> </table>	Kind	Value	pattern	[01]
Kind	Value				
pattern	[01]				

complexType Quadro_K_Type

diagram	
namespace	urn:www.agenziaentrate.gov.it:specificheTecniche:sco:730
children	m730:DatiCondominio m730:DatiCatastali m730:DomandaAccatastamento m730:DatiFornitore

element **Quadro_K_Type/DatiCondominio**

diagram	
namespace	urn:www.agenziaentrate.gov.it:specificheTecniche:sco:730
type	m730:Dati_Condominio_Type
children	m730:CodiceFiscale m730:Denominazione

element **Quadro_K_Type/DatiCatastali**

diagram	
namespace	urn:www.agenziaentrate.gov.it:specificheTecniche:sco:730
type	m730:Dati_Catastali_Type
children	m730:CodiceComune m730:TerreniUrbano m730:SezioneUrbanaComuneCatastale m730:Foglio m730:Particella m730:Subalterno

element **Quadro_K_Type/DomandaAccatastamento**

diagram	
namespace	urn:www.agenziaentrate.gov.it:specificheTecniche:sco:730
type	m730:Domanda_Accatastamento_Type
children	m730:Data m730:Numero m730:ProvinciaUfficio

namespace	urn:www.agenziaentrate.gov.it:specificheTecniche:sco:730
type	m730:Domanda Accatastamento Type
children	m730:Data m730:Numero m730:ProvinciaUfficio

element **Quadro_K_Type/DatiFornitore**

diagram	
namespace	urn:www.agenziaentrate.gov.it:specificheTecniche:sco:730
type	m730:Dati Fornitore Type
children	m730:CodiceFiscale m730:CognomeDenom m730:Nome m730:Sesso m730:DataNascita m730:ComuneNascita m730:ProvinciaNascita m730:ImportoAcquisti

complexType **Rappresentante_Type**

diagram	
namespace	urn:www.agenziaentrate.gov.it:specificheTecniche:sco:730
children	m730:SoggettoFiscale m730:DatiAnagrafici m730:ResidenzaAnagrafica m730:Firma

element **Rappresentante_Type/SoggettoFiscale**

diagram	
namespace	urn:www.agenziaentrate.gov.it:specificheTecniche:sco:730
type	m730:Soggetto_Fiscale_730_Type
children	m730:CodiceFiscale m730:Email m730:Telefono m730:Cellulare

element **Rappresentante_Type/DatiAnagrafici**

diagram	
namespace	urn:www.agenziaentrate.gov.it:specificheTecniche:sco:730
type	Dati_Anagrafici_Type
children	Cognome Nome Sesso DataNascita ComuneNascita ProvinciaNascita

element **Rappresentante_Type/ResidenzaAnagrafica**

diagram	
namespace	urn:www.agenziaentrate.gov.it:specificheTecniche:sco:730
type	m730:Residenza_Rappresentante_Type
children	Comune Provincia CodiceComune Indirizzo Cap m730:Tipologia m730:NumCivico m730:Frazione

element **Rappresentante_Type/Firma**

diagram					
namespace	urn:www.agenziaentrate.gov.it:specificheTecniche:sco:730				
type	DatoCB_Type				
facets	<table border="1"> <thead> <tr> <th>Kind</th> <th>Value</th> </tr> </thead> <tbody> <tr> <td>pattern</td> <td>[01]</td> </tr> </tbody> </table>	Kind	Value	pattern	[01]
Kind	Value				
pattern	[01]				

complexType **Redditi_Capitale_Type**

diagram	
namespace	urn:www.agenziaentrate.gov.it:specificheTecniche:sco:730

children	m730:Utili m730:AltriRedditiDiCapitale m730:LavoroAutonomo m730:RedditiDiversi m730:RedditiDiversiDetraz
----------	--

element **Redditi_Capitale_Type/Utili**

diagram	
namespace	urn:www.agenziaentrate.gov.it:specificheTecniche:sco:730
type	m730:Altri_Redditi_Utili_Type
children	m730:Tipo_Reddito m730:RedditiRitenute

element **Redditi_Capitale_Type/AltriRedditiDiCapitale**

diagram	
namespace	urn:www.agenziaentrate.gov.it:specificheTecniche:sco:730
type	m730:Sezione_Altri_Redd_Type
children	m730:TipoReddito m730:RedditiRitenute

element **Redditi_Capitale_Type/LavoroAutonomo**

diagram	
namespace	urn:www.agenziaentrate.gov.it:specificheTecniche:sco:730
type	m730:Altri_Redditi_Lavoro_Autonomo_Type
children	m730:TipoReddito m730:RedditiRitenute

element **Redditi_Capitale_Type/RedditiDiversi**

diagram	
namespace	urn:www.agenziaentrate.gov.it:specificheTecniche:sco:730
type	m730:Altri_Redditi_Diversi_Type
children	m730:TipoReddito m730:RedditiRitenuteSpese

element **Redditi_Capitale_Type/RedditiDiversiDetraz**

diagram	
namespace	urn:www.agenziaentrate.gov.it:specificheTecniche:sco:730
type	m730:Altri_Redditi_Diversi_Detr_Type
children	m730:Tipo_Reddito m730:RedditiRitenuteSpese

complexType **Redditi_Eredi_Legatari_Type**

diagram	
namespace	urn:www.agenziaentrate.gov.it:specificheTecniche:sco:730
type	extension of m730:Tassazione_Separata_Type
children	m730:Opzione m730:Anno m730:RedditoRitenute m730:TipoReddito m730:RedditoTotale m730:QuotaImposteSuccessioni

	m730:QuotalmposteSuccessioni
--	--

element **Redditi_Eredi_Legatari_Type/TipoReddito**

diagram																													
namespace	urn:www.agenziaentrate.gov.it:specificheTecniche:sco:730																												
type	m730:Tipo_Redito_Da1a12_Type																												
facets	<table border="1"> <thead> <tr> <th>Kind</th> <th>Value</th> </tr> </thead> <tbody> <tr> <td>pattern</td> <td>[1-9]{1}[0-9]*</td> </tr> <tr> <td>enumeration</td> <td>1</td> </tr> <tr> <td>enumeration</td> <td>2</td> </tr> <tr> <td>enumeration</td> <td>3</td> </tr> <tr> <td>enumeration</td> <td>4</td> </tr> <tr> <td>enumeration</td> <td>5</td> </tr> <tr> <td>enumeration</td> <td>6</td> </tr> <tr> <td>enumeration</td> <td>7</td> </tr> <tr> <td>enumeration</td> <td>8</td> </tr> <tr> <td>enumeration</td> <td>9</td> </tr> <tr> <td>enumeration</td> <td>10</td> </tr> <tr> <td>enumeration</td> <td>11</td> </tr> <tr> <td>enumeration</td> <td>12</td> </tr> </tbody> </table>	Kind	Value	pattern	[1-9]{1}[0-9]*	enumeration	1	enumeration	2	enumeration	3	enumeration	4	enumeration	5	enumeration	6	enumeration	7	enumeration	8	enumeration	9	enumeration	10	enumeration	11	enumeration	12
Kind	Value																												
pattern	[1-9]{1}[0-9]*																												
enumeration	1																												
enumeration	2																												
enumeration	3																												
enumeration	4																												
enumeration	5																												
enumeration	6																												
enumeration	7																												
enumeration	8																												
enumeration	9																												
enumeration	10																												
enumeration	11																												
enumeration	12																												

element **Redditi_Eredi_Legatari_Type/RedditoTotale**

diagram					
namespace	urn:www.agenziaentrate.gov.it:specificheTecniche:sco:730				
type	DatoNP_Type				
facets	<table border="1"> <thead> <tr> <th>Kind</th> <th>Value</th> </tr> </thead> <tbody> <tr> <td>pattern</td> <td>[1-9]{1}[0-9]*</td> </tr> </tbody> </table>	Kind	Value	pattern	[1-9]{1}[0-9]*
Kind	Value				
pattern	[1-9]{1}[0-9]*				

element **Redditi_Eredi_Legatari_Type/QuotalmposteSuccessioni**

diagram					
namespace	urn:www.agenziaentrate.gov.it:specificheTecniche:sco:730				
type	DatoNP_Type				
facets	<table border="1"> <thead> <tr> <th>Kind</th> <th>Value</th> </tr> </thead> <tbody> <tr> <td>pattern</td> <td>[1-9]{1}[0-9]*</td> </tr> </tbody> </table>	Kind	Value	pattern	[1-9]{1}[0-9]*
Kind	Value				
pattern	[1-9]{1}[0-9]*				

complexType **Redditi_Fabbricati_Type**

diagram	
namespace	urn:www.agenziaentrate.gov.it:specificheTecniche:sco:730
children	m730:Modulo

element **Redditi_Fabbricati_Type/Modulo**

diagram	
namespace	urn:www.agenziaentrate.gov.it:specificheTecniche:sco:730
type	m730:Modulo_Fabbricato_Type
children	m730:FabbricatoOrd m730:FabbricatoAgev

complexType **Redditi_Lavoro_Dip_Type**

diagram	
namespace	urn:www.agenziaentrate.gov.it:specificheTecniche:sco:730
children	m730:PrimoModulo m730:Modulo

element **Redditi_Lavoro_Dip_Type/PrimoModulo**

<p>diagram</p>	
<p>namespace</p>	<p>urn:www.agenziaentrate.gov.it:specificheTecniche:sco:730</p>
<p>type</p>	<p>m730:Primo Modulo Lavoro Dip Type</p>
<p>children</p>	<p>m730:LavoroDipendente m730:PremiRisultato m730:PeriodoLavoro m730:AltriRedditiAssLavDip m730:RitenuteLavoroDipendente m730:Bonuslrpef m730:RedditoAlNettoContribPensioni m730:ContribSolidarietaTrattenuto m730:CasellaCasiParticolari</p>

element **Redditi_Lavoro_Dip_Type/Modulo**

<p>diagram</p>	
<p>namespace</p>	<p>urn:www.agenziaentrate.gov.it:specificheTecniche:sco:730</p>
<p>type</p>	<p>m730:Modulo Lavoro Dip Type</p>

children	m730:LavoroDipendente m730:PremiRisultato m730:AltriRedditiAssLavDip m730:BonusIrfp
----------	---

complexType Redditi_Ritenute_Spese_Type

diagram	
namespace	urn:www.agenziaentrate.gov.it:specificheTecniche:sco:730
type	extension of m730:Redditi_Ritenute_Type
children	m730:ImportoRedditi m730:ImportoRitenute m730:ImportoSpese

element Redditi_Ritenute_Spese_Type/ImportoSpese

diagram					
namespace	urn:www.agenziaentrate.gov.it:specificheTecniche:sco:730				
type	DatoNP_Type				
facets	<table border="1"> <thead> <tr> <th>Kind</th> <th>Value</th> </tr> </thead> <tbody> <tr> <td>pattern</td> <td>[1-9]{1}[0-9]*</td> </tr> </tbody> </table>	Kind	Value	pattern	[1-9]{1}[0-9]*
Kind	Value				
pattern	[1-9]{1}[0-9]*				

complexType Redditi_Ritenute_Type

diagram	
namespace	urn:www.agenziaentrate.gov.it:specificheTecniche:sco:730
children	m730:ImportoRedditi m730:ImportoRitenute

element Redditi_Ritenute_Type/ImportoRedditi

diagram					
namespace	urn:www.agenziaentrate.gov.it:specificheTecniche:sco:730				
type	DatoNP_Type				
facets	<table border="1"> <thead> <tr> <th>Kind</th> <th>Value</th> </tr> </thead> <tbody> <tr> <td>pattern</td> <td>[1-9]{1}[0-9]*</td> </tr> </tbody> </table>	Kind	Value	pattern	[1-9]{1}[0-9]*
Kind	Value				
pattern	[1-9]{1}[0-9]*				

element **Redditi_Ritenute_Type/ImportoRitenute**

diagram	
namespace	urn:www.agenziaentrate.gov.it:specificheTecniche:sco:730
type	DatoNP_Type
facets	Kind Value pattern [1-9]{1}[0-9]*

complexType **Redditi_Tassazione_Separata_Type**

diagram	
namespace	urn:www.agenziaentrate.gov.it:specificheTecniche:sco:730
children	m730:RedditiErede m730:ImposteRimborsate

element **Redditi_Tassazione_Separata_Type/RedditiErede**

diagram	
namespace	urn:www.agenziaentrate.gov.it:specificheTecniche:sco:730
type	m730:Redditi Eredi Legatari Type
children	m730:Opzione m730:Anno m730:RedditoRitenute m730:TipoReddito m730:RedditoTotale m730:QuotaImposteSuccessioni

element **Redditi_Tassazione_Separata_Type/ImposteRimborsate**

diagram	
namespace	urn:www.agenziaentrate.gov.it:specificheTecniche:sco:730
type	m730:Imposte_Rimborsate_Type
children	m730:TipoReddito m730:TassazioneSeparata

complexType **Redditi_Terreni_Type**

diagram	
namespace	urn:www.agenziaentrate.gov.it:specificheTecniche:sco:730
children	m730:Modulo

element **Redditi_Terreni_Type/Modulo**

diagram	
namespace	urn:www.agenziaentrate.gov.it:specificheTecniche:sco:730
type	m730:Modulo_Terreno_Type
children	m730:Terreno

complexType **Reddito_Erede_Type**

diagram	
namespace	urn:www.agenziaentrate.gov.it:specificheTecniche:sco:730

type	extension of m730:Tassazione Separata Type
children	m730:Opzione m730:Anno m730:RedditoRitenute

complexType **Residenza_Anagrafica_730_Type**

diagram	
namespace	urn:www.agenziaentrate.gov.it:specificheTecniche:sco:730
type	extension of Residenza_Anagrafica_Type
children	Comune Provincia CodiceComune Indirizzo Cap DataVariazione m730:Tipologia m730:NumCivico m730:Frazione m730:PrimaPresentazione

element **Residenza_Anagrafica_730_Type/Tipologia**

diagram					
namespace	urn:www.agenziaentrate.gov.it:specificheTecniche:sco:730				
type	DatoAN_Type				
facets	<table border="1"> <tr> <td>Kind</td> <td>Value</td> </tr> <tr> <td>pattern</td> <td>(([0-9A-Z-] \&quot;){1}([0-9A-Z&amp;:] [-\., / ° ' \(\) \) À È É Ì Ò Ù Ü &quot; \N \+)*</td> </tr> </table>	Kind	Value	pattern	(([0-9A-Z-] \"){1}([0-9A-Z&:] [-\., / ° ' \(\) \) À È É Ì Ò Ù Ü " \N \+)*
Kind	Value				
pattern	(([0-9A-Z-] \"){1}([0-9A-Z&:] [-\., / ° ' \(\) \) À È É Ì Ò Ù Ü " \N \+)*				

element **Residenza_Anagrafica_730_Type/NumCivico**

diagram	
---------	--

namespace	urn:www.agenziaentrate.gov.it:specificheTecniche:sco:730
type	DatoAN_Type
facets	Kind Value pattern ([0-9A-Z\-\"]{1})([0-9A-Z&:] ' - \., / ° '¥\(\)\ À É È Ì Ò Ù Û " \ \\ \ +)*

element **Residenza_Anagrafica_730_Type/Frazione**

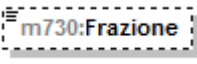
diagram	
namespace	urn:www.agenziaentrate.gov.it:specificheTecniche:sco:730
type	DatoAN_Type
facets	Kind Value pattern ([0-9A-Z\-\"]{1})([0-9A-Z&:] ' - \., / ° '¥\(\)\ À É È Ì Ò Ù Û " \ \\ \ +)*

element **Residenza_Anagrafica_730_Type/PrimaPresentazione**

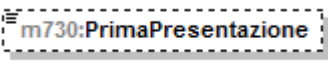
diagram	
namespace	urn:www.agenziaentrate.gov.it:specificheTecniche:sco:730
type	DatoCB_Type
facets	Kind Value pattern [01]

complexType **Residenza_Rappresentante_Type**

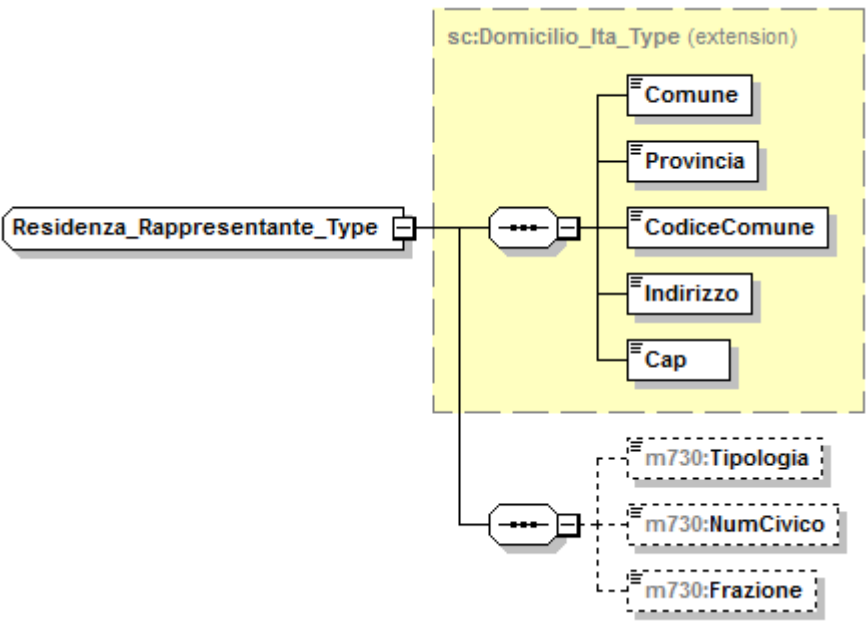
diagram	 <p>The diagram illustrates the structure of the Residenza_Rappresentante_Type complex type. It is an extension of the sc:Domicilio_Ita_Type (shown in a yellow dashed box). The extension includes the following elements:</p> <ul style="list-style-type: none"> Comune (required field) Provincia (required field) CodiceComune (required field) Indirizzo (required field) Cap (required field) m730:Tipologia (optional field, shown in a dashed box) m730:NumCivico (optional field, shown in a dashed box) m730:Frazione (optional field, shown in a dashed box)
namespace	urn:www.agenziaentrate.gov.it:specificheTecniche:sco:730
type	extension of Domicilio_Ita_Type

children	Comune Provincia CodiceComune Indirizzo Cap m730:Tipologia m730:NumCivico m730:Frazione
----------	---

element **Residenza_Rappresentante_Type/Tipologia**

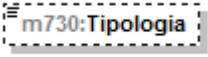
diagram	
namespace	urn:www.agenziaentrate.gov.it:specificheTecniche:sco:730
type	DatoAN_Type
facets	Kind Value pattern ([0-9A-Z-]*)"){1}([0-9A-Z&:] "- \., / "^\(\) \) À É È Ì Ò Ù Ü " \ \ \+)*

element **Residenza_Rappresentante_Type/NumCivico**

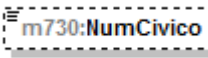
diagram	
namespace	urn:www.agenziaentrate.gov.it:specificheTecniche:sco:730
type	DatoAN_Type
facets	Kind Value pattern ([0-9A-Z-]*)"){1}([0-9A-Z&:] "- \., / "^\(\) \) À É È Ì Ò Ù Ü " \ \ \+)*

element **Residenza_Rappresentante_Type/Frazione**

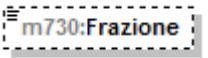
diagram	
namespace	urn:www.agenziaentrate.gov.it:specificheTecniche:sco:730
type	DatoAN_Type
facets	Kind Value pattern ([0-9A-Z-]*)"){1}([0-9A-Z&:] "- \., / "^\(\) \) À É È Ì Ò Ù Ü " \ \ \+)*

complexType **Residenza_Type**

diagram	
namespace	urn:www.agenziaentrate.gov.it:specificheTecniche:sco:730
children	m730:Comune m730:Provincia m730:CodiceComune m730:Cap m730:Tipologia m730:Indirizzo m730:NumCivico m730:Frazione m730:Email m730:Telefono

element **Residenza_Type/Comune**

diagram					
namespace	urn:www.agenziaentrate.gov.it:specificheTecniche:sco:730				
type	DatoAN_Type				
facets	<table border="0"> <tr> <td>Kind</td> <td>Value</td> </tr> <tr> <td>pattern</td> <td>(([0-9A-Z\-\]]&quot;){1}([0-9A-Z&amp;:] ' \- \., / ^*\(\ \)\ À È É Ì Ò Ù Û &quot; \ \\ /+)*</td> </tr> </table>	Kind	Value	pattern	(([0-9A-Z\-\]]"){1}([0-9A-Z&:] ' \- \., / ^*\(\ \)\ À È É Ì Ò Ù Û " \ \\ /+)*
Kind	Value				
pattern	(([0-9A-Z\-\]]"){1}([0-9A-Z&:] ' \- \., / ^*\(\ \)\ À È É Ì Ò Ù Û " \ \\ /+)*				

element **Residenza_Type/Provincia**

diagram	
namespace	urn:www.agenziaentrate.gov.it:specificheTecniche:sco:730
type	PR_Type

element **Residenza_Type/CodiceComune**

diagram	
---------	--

namespace	urn:www.agenziaentrate.gov.it:specificheTecniche:sco:730
type	DatoAN_Type
facets	Kind Value pattern ([0-9A-Z\-\-]"){1}([0-9A-Z&:] ' \"- \". , / ° '\"\\(\\)À È É Ì Ò Ù Ü " \\\" \\+)*

element **Residenza_Type/Cap**

diagram	
namespace	urn:www.agenziaentrate.gov.it:specificheTecniche:sco:730
type	DatoAN_Type
facets	Kind Value pattern ([0-9A-Z\-\-]"){1}([0-9A-Z&:] ' \"- \". , / ° '\"\\(\\)À È É Ì Ò Ù Ü " \\\" \\+)*

element **Residenza_Type/Tipologia**

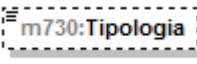
diagram	
namespace	urn:www.agenziaentrate.gov.it:specificheTecniche:sco:730
type	DatoAN_Type
facets	Kind Value pattern ([0-9A-Z\-\-]"){1}([0-9A-Z&:] ' \"- \". , / ° '\"\\(\\)À È É Ì Ò Ù Ü " \\\" \\+)*

element **Residenza_Type/Indirizzo**

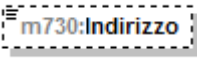
diagram	
namespace	urn:www.agenziaentrate.gov.it:specificheTecniche:sco:730
type	DatoAN_Type
facets	Kind Value pattern ([0-9A-Z\-\-]"){1}([0-9A-Z&:] ' \"- \". , / ° '\"\\(\\)À È É Ì Ò Ù Ü " \\\" \\+)*

element **Residenza_Type/NumCivico**

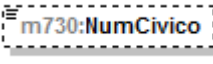
diagram	
namespace	urn:www.agenziaentrate.gov.it:specificheTecniche:sco:730
type	DatoAN_Type
facets	Kind Value pattern ([0-9A-Z\-\-]"){1}([0-9A-Z&:] ' \"- \". , / ° '\"\\(\\)À È É Ì Ò Ù Ü " \\\" \\+)*

element **Residenza_Type/Frazione**

diagram	
namespace	urn:www.agenziaentrate.gov.it:specificheTecniche:sco:730
type	DatoAN_Type
facets	Kind Value pattern ([0-9A-Z-] \"){1}([0-9A-Z&] '\- \., /'°\^\(\)\ À É È Ì Ò Ù Ü " \ \\ \ +)*

element **Residenza_Type/Email**

diagram	
namespace	urn:www.agenziaentrate.gov.it:specificheTecniche:sco:730
type	DatoEM_Type
facets	Kind Value pattern [a-zA-Z0-9._%\-'\"?^~=]+@[a-zA-Z0-9.\-]+\.[a-zA-Z]{2,4}

element **Residenza_Type/Telefono**

diagram	
namespace	urn:www.agenziaentrate.gov.it:specificheTecniche:sco:730
type	DatoAN_Type
facets	Kind Value pattern ([0-9A-Z-] \"){1}([0-9A-Z&] '\- \., /'°\^\(\)\ À É È Ì Ò Ù Ü " \ \\ \ +)*

complexType **Residuo_Credito_Compens_Annolmposta_Type**

diagram	
namespace	urn:www.agenziaentrate.gov.it:specificheTecniche:sco:730
type	extension of m730:Residuo_Credito_Compens_Type
children	m730:CreditoAnno m730:DiCuiCompensatoF24

complexType **Residuo_Credito_Compens_Type**

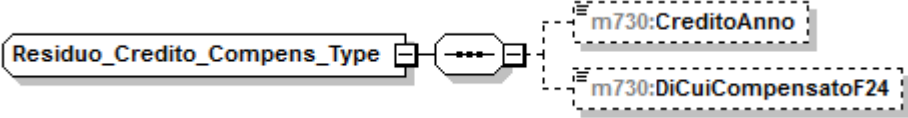
diagram	
namespace	urn:www.agenziaentrate.gov.it:specificheTecniche:sco:730
children	m730:CreditoAnno m730:DiCuiCompensatoF24

element **Residuo_Credito_Compens_Type/CreditoAnno**

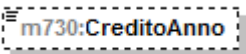
diagram					
namespace	urn:www.agenziaentrate.gov.it:specificheTecniche:sco:730				
type	DatoNP_Type				
facets	<table border="1"> <tr> <td>Kind</td> <td>Value</td> </tr> <tr> <td>pattern</td> <td>[1-9]{1}[0-9]*</td> </tr> </table>	Kind	Value	pattern	[1-9]{1}[0-9]*
Kind	Value				
pattern	[1-9]{1}[0-9]*				

element **Residuo_Credito_Compens_Type/DiCuiCompensatoF24**

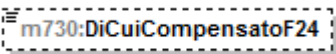
diagram					
namespace	urn:www.agenziaentrate.gov.it:specificheTecniche:sco:730				
type	DatoNP_Type				
facets	<table border="1"> <tr> <td>Kind</td> <td>Value</td> </tr> <tr> <td>pattern</td> <td>[1-9]{1}[0-9]*</td> </tr> </table>	Kind	Value	pattern	[1-9]{1}[0-9]*
Kind	Value				
pattern	[1-9]{1}[0-9]*				

complexType **Residuo_Fabbricati_Type**

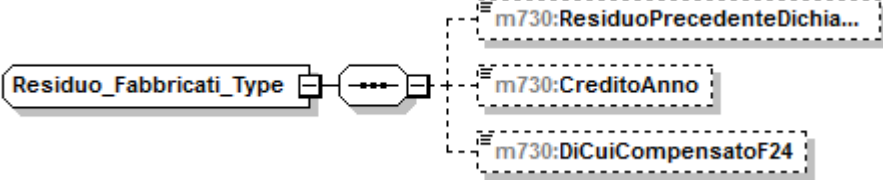
diagram	
namespace	urn:www.agenziaentrate.gov.it:specificheTecniche:sco:730
children	m730:ResiduoPrecedenteDichiarazione m730:CreditoAnno m730:DiCuiCompensatoF24

element **Residuo_Fabbricati_Type/ResiduoPrecedenteDichiarazione**

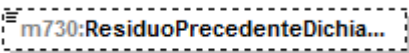
diagram	
namespace	urn:www.agenziaentrate.gov.it:specificheTecniche:sco:730
type	DatoNP_Type

facets	Kind	Value
	pattern	[1-9]{1}[0-9]*

element **Residuo_Fabbricati_Type/CreditoAnno**

diagram	
namespace	urn:www.agenziaentrate.gov.it:specificheTecniche:sco:730
type	DatoNP_Type
facets	Kind Value pattern [1-9]{1}[0-9]*

element **Residuo_Fabbricati_Type/DiCuiCompensatoF24**

diagram	
namespace	urn:www.agenziaentrate.gov.it:specificheTecniche:sco:730
type	DatoNP_Type
facets	Kind Value pattern [1-9]{1}[0-9]*

complexType **Restituzione_Somme_Type**

diagram	
namespace	urn:www.agenziaentrate.gov.it:specificheTecniche:sco:730
children	m730:SommeRestituite m730:ResiduoPrecedenteDic

element **Restituzione_Somme_Type/SommeRestituite**

diagram	
namespace	urn:www.agenziaentrate.gov.it:specificheTecniche:sco:730
type	DatoNP_Type
facets	Kind Value pattern [1-9]{1}[0-9]*

element **Restituzione_Somme_Type/ResiduoPrecedenteDic**

diagram	
namespace	urn:www.agenziaentrate.gov.it:specificheTecniche:sco:730

type	DatoNP_Type
facets	Kind Value pattern [1-9]{1}[0-9]*

complexType Rettifica_Type

diagram	
namespace	urn:www.agenziaentrate.gov.it:specificheTecniche:sco:730
children	m730:Quadro m730:Rigo m730:Colonna m730:Modulo m730:DatoRimosso

element Rettifica_Type/Quadro

diagram	
namespace	urn:www.agenziaentrate.gov.it:specificheTecniche:sco:730
type	DatoAN_Type
facets	Kind Value pattern ([0-9A-Z\-_]"){1}([0-9A-Z&:] ' - \., /° ^\(\ \) À É È Ì Ò Ù Û " \\ / +)*

element Rettifica_Type/Rigo

diagram	
namespace	urn:www.agenziaentrate.gov.it:specificheTecniche:sco:730
type	DatoNP_Type
facets	Kind Value pattern [1-9]{1}[0-9]*

element Rettifica_Type/Colonna

diagram	
namespace	urn:www.agenziaentrate.gov.it:specificheTecniche:sco:730
type	DatoNP_Type
facets	Kind Value pattern [1-9]{1}[0-9]*

element **Rettifica_Type/Modulo**

diagram	
namespace	urn:www.agenziaentrate.gov.it:specificheTecniche:sco:730
type	DatoNP_Type
facets	Kind Value pattern [1-9]{1}[0-9]*

element **Rettifica_Type/DatoRimosso**

diagram	
namespace	urn:www.agenziaentrate.gov.it:specificheTecniche:sco:730
type	DatoCB_Type
facets	Kind Value pattern [01]

complexType **Riepilogo_Redditi_Type**

diagram	
namespace	urn:www.agenziaentrate.gov.it:specificheTecniche:sco:730
children	m730:Dominicali m730:Agrari m730:Fabbricati m730:LavDip m730:AltriRedditi m730:ImponibileCedolare m730:ImponibileCedolareOrdinario m730:ImponibileCedolareAgevolato m730:AbitazionePrincipalePertinenze

element Riepilogo_Reddito_Type/Dominicali

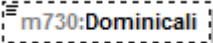
diagram	
namespace	urn:www.agenziaentrate.gov.it:specificheTecniche:sco:730
type	DatoNP_Type
facets	Kind Value pattern [1-9]{1}[0-9]*

element Riepilogo_Reddito_Type/Agrari

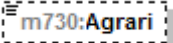
diagram	
namespace	urn:www.agenziaentrate.gov.it:specificheTecniche:sco:730
type	DatoNP_Type
facets	Kind Value pattern [1-9]{1}[0-9]*

element Riepilogo_Reddito_Type/Fabbricati

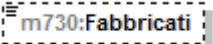
diagram	
namespace	urn:www.agenziaentrate.gov.it:specificheTecniche:sco:730
type	DatoNP_Type
facets	Kind Value pattern [1-9]{1}[0-9]*

element Riepilogo_Reddito_Type/LavDip

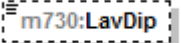
diagram	
namespace	urn:www.agenziaentrate.gov.it:specificheTecniche:sco:730
type	DatoNP_Type
facets	Kind Value pattern [1-9]{1}[0-9]*

element Riepilogo_Reddito_Type/AltriRedditi

diagram	
namespace	urn:www.agenziaentrate.gov.it:specificheTecniche:sco:730
type	DatoNP_Type
facets	Kind Value pattern [1-9]{1}[0-9]*

element Riepilogo_Reddi_Type/ImponibileCedolare

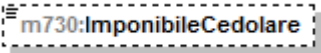
diagram					
namespace	urn:www.agenziaentrate.gov.it:specificheTecniche:sco:730				
type	DatoNP_Type				
facets	<table border="0"> <tr> <td>Kind</td> <td>Value</td> </tr> <tr> <td>pattern</td> <td>[1-9]{1}[0-9]*</td> </tr> </table>	Kind	Value	pattern	[1-9]{1}[0-9]*
Kind	Value				
pattern	[1-9]{1}[0-9]*				

element Riepilogo_Reddi_Type/ImponibileCedolareOrdinario

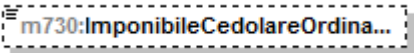
diagram					
namespace	urn:www.agenziaentrate.gov.it:specificheTecniche:sco:730				
type	DatoNP_Type				
facets	<table border="0"> <tr> <td>Kind</td> <td>Value</td> </tr> <tr> <td>pattern</td> <td>[1-9]{1}[0-9]*</td> </tr> </table>	Kind	Value	pattern	[1-9]{1}[0-9]*
Kind	Value				
pattern	[1-9]{1}[0-9]*				

element Riepilogo_Reddi_Type/ImponibileCedolareAgevolato

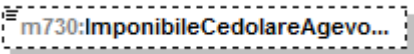
diagram					
namespace	urn:www.agenziaentrate.gov.it:specificheTecniche:sco:730				
type	DatoNP_Type				
facets	<table border="0"> <tr> <td>Kind</td> <td>Value</td> </tr> <tr> <td>pattern</td> <td>[1-9]{1}[0-9]*</td> </tr> </table>	Kind	Value	pattern	[1-9]{1}[0-9]*
Kind	Value				
pattern	[1-9]{1}[0-9]*				

element Riepilogo_Reddi_Type/AbitazionePrincipalePertinenze

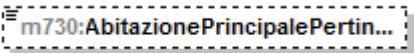
diagram					
namespace	urn:www.agenziaentrate.gov.it:specificheTecniche:sco:730				
type	DatoNP_Type				
facets	<table border="0"> <tr> <td>Kind</td> <td>Value</td> </tr> <tr> <td>pattern</td> <td>[1-9]{1}[0-9]*</td> </tr> </table>	Kind	Value	pattern	[1-9]{1}[0-9]*
Kind	Value				
pattern	[1-9]{1}[0-9]*				

complexType **Ritenute_Acconti_Sospesi_Type**

diagram	
namespace	urn:www.agenziaentrate.gov.it:specificheTecniche:sco:730
children	m730:CodiceEvento m730:lrp ef m730:AddRegionalelrp ef m730:AddComunalelrp ef m730:SostitutivaPremi m730:CedolareSecca m730:ContribSolidarieta

element **Ritenute_Acconti_Sospesi_Type/CodiceEvento**

diagram																	
namespace	urn:www.agenziaentrate.gov.it:specificheTecniche:sco:730																
type	m730:Codice Evento Eccezionale Type																
facets	<table border="1"> <thead> <tr> <th>Kind</th> <th>Value</th> </tr> </thead> <tbody> <tr> <td>pattern</td> <td>[1-9]{1}[0-9]*</td> </tr> <tr> <td>enumeration</td> <td>1</td> </tr> <tr> <td>enumeration</td> <td>2</td> </tr> <tr> <td>enumeration</td> <td>3</td> </tr> <tr> <td>enumeration</td> <td>4</td> </tr> <tr> <td>enumeration</td> <td>5</td> </tr> <tr> <td>enumeration</td> <td>6</td> </tr> </tbody> </table>	Kind	Value	pattern	[1-9]{1}[0-9]*	enumeration	1	enumeration	2	enumeration	3	enumeration	4	enumeration	5	enumeration	6
Kind	Value																
pattern	[1-9]{1}[0-9]*																
enumeration	1																
enumeration	2																
enumeration	3																
enumeration	4																
enumeration	5																
enumeration	6																

element **Ritenute_Acconti_Sospesi_Type/lrp ef**

diagram					
namespace	urn:www.agenziaentrate.gov.it:specificheTecniche:sco:730				
type	DatoNP Type				
facets	<table border="1"> <thead> <tr> <th>Kind</th> <th>Value</th> </tr> </thead> <tbody> <tr> <td>pattern</td> <td>[1-9]{1}[0-9]*</td> </tr> </tbody> </table>	Kind	Value	pattern	[1-9]{1}[0-9]*
Kind	Value				
pattern	[1-9]{1}[0-9]*				

element **Ritenute_Acconti_Sospesi_Type/AddRegionalelrp ef**

diagram	
---------	--

namespace	urn:www.agenziaentrate.gov.it:specificheTecniche:sco:730
type	DatoNP_Type
facets	Kind Value pattern [1-9]{1}[0-9]*

element **Ritenute_Acconti_Sospesi_Type/AddComunaleIrpef**

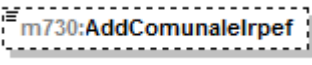
diagram	
namespace	urn:www.agenziaentrate.gov.it:specificheTecniche:sco:730
type	DatoNP_Type
facets	Kind Value pattern [1-9]{1}[0-9]*

element **Ritenute_Acconti_Sospesi_Type/SostitutivaPremi**

diagram	
namespace	urn:www.agenziaentrate.gov.it:specificheTecniche:sco:730
type	DatoNP_Type
facets	Kind Value pattern [1-9]{1}[0-9]*

element **Ritenute_Acconti_Sospesi_Type/CedolareSecca**

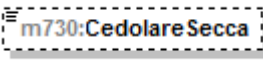
diagram	
namespace	urn:www.agenziaentrate.gov.it:specificheTecniche:sco:730
type	DatoNP_Type
facets	Kind Value pattern [1-9]{1}[0-9]*

element **Ritenute_Acconti_Sospesi_Type/ContribSolidarieta**

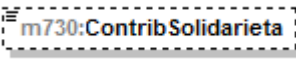
diagram	
namespace	urn:www.agenziaentrate.gov.it:specificheTecniche:sco:730
type	DatoNP_Type
facets	Kind Value pattern [1-9]{1}[0-9]*

complexType **Ritenute_Lavoro_Dip_Type**

diagram	
namespace	urn:www.agenziaentrate.gov.it:specificheTecniche:sco:730
children	m730:Ritlrpef m730:RitAddRegionale m730:RitAccAddComunale m730:RitSaldoAddComunale m730:RitAccAddComAnnoPres

element **Ritenute_Lavoro_Dip_Type/Ritlrpef**

diagram					
namespace	urn:www.agenziaentrate.gov.it:specificheTecniche:sco:730				
type	DatoNP_Type				
facets	<table border="1"> <tr> <td>Kind</td> <td>Value</td> </tr> <tr> <td>pattern</td> <td>[1-9]{1}[0-9]*</td> </tr> </table>	Kind	Value	pattern	[1-9]{1}[0-9]*
Kind	Value				
pattern	[1-9]{1}[0-9]*				

element **Ritenute_Lavoro_Dip_Type/RitAddRegionale**

diagram					
namespace	urn:www.agenziaentrate.gov.it:specificheTecniche:sco:730				
type	DatoNP_Type				
facets	<table border="1"> <tr> <td>Kind</td> <td>Value</td> </tr> <tr> <td>pattern</td> <td>[1-9]{1}[0-9]*</td> </tr> </table>	Kind	Value	pattern	[1-9]{1}[0-9]*
Kind	Value				
pattern	[1-9]{1}[0-9]*				

element **Ritenute_Lavoro_Dip_Type/RitAccAddComunale**

diagram					
namespace	urn:www.agenziaentrate.gov.it:specificheTecniche:sco:730				
type	DatoNP_Type				
facets	<table border="1"> <tr> <td>Kind</td> <td>Value</td> </tr> <tr> <td>pattern</td> <td>[1-9]{1}[0-9]*</td> </tr> </table>	Kind	Value	pattern	[1-9]{1}[0-9]*
Kind	Value				
pattern	[1-9]{1}[0-9]*				

element **Ritenute_Lavoro_Dip_Type/RitSaldoAddComunale**

diagram	
namespace	urn:www.agenziaentrate.gov.it:specificheTecniche:sco:730
type	DatoNP_Type
facets	Kind Value pattern [1-9]{1}[0-9]*

element **Ritenute_Lavoro_Dip_Type/RitAccAddComAnnoPres**

diagram	
namespace	urn:www.agenziaentrate.gov.it:specificheTecniche:sco:730
type	DatoNP_Type
facets	Kind Value pattern [1-9]{1}[0-9]*

complexType **Sezione_Altri_Reddi_Type**

diagram	
namespace	urn:www.agenziaentrate.gov.it:specificheTecniche:sco:730
children	m730:TipoReddito m730:RedditiRitenute

element **Sezione_Altri_Reddi_Type/TipoReddito**

diagram	
namespace	urn:www.agenziaentrate.gov.it:specificheTecniche:sco:730
type	m730:Tipo_Reddito_Da1a8_Type
facets	Kind Value pattern [1-9]{1}[0-9]* enumeration 1 enumeration 2 enumeration 3 enumeration 4 enumeration 5 enumeration 6 enumeration 7 enumeration 8

element **Sezione_Altri_Redd_Type/RedditiRitenute**

diagram	
namespace	urn:www.agenziaentrate.gov.it:specificheTecniche:sco:730
type	m730:Redditi Ritenute Type
children	m730:ImportoRedditi m730:ImportoRitenute

complexType **Sezione_Dati_Catastali_Recupero_Patrimonio_Edilizio_Type**

diagram	
namespace	urn:www.agenziaentrate.gov.it:specificheTecniche:sco:730
children	m730:DatiCatastaliRecuperoPatrimonioEdilizio m730:DatiRegistrazioneAccatastamentoRecuperoPatrimonio Edilizio

element **Sezione_Dati_Catastali_Recupero_Patrimonio_Edilizio_Type/DatiCatastaliRecuperoPatrimonioEdilizio**

diagram	
namespace	urn:www.agenziaentrate.gov.it:specificheTecniche:sco:730
type	extension of m730:Dati_Catastali_Recupero_Patrimonio_Edilizio_Type
children	m730:NOrdImmobile m730:Condominio m730:DatiCatastali

element

Sezione_Dati_Catastali_Recupero_Patrimonio_Edilizio_Type/DatiRegistrazioneAccatastamentoRecuperoPatrimonio_Edilizio

diagram	
namespace	urn:www.agenziaentrate.gov.it:specificheTecniche:sco:730
type	m730:Dati_Registrazione_Accatastamento_Recupero_Patrimonio_Edilizio_Type
children	m730:NOrdImmobile m730:Condominio m730:EstremiRegistrazioneContratto m730:DomandaAccatastamento

complexType Soggetto_Assistenza_Fiscale_Doc_Type

diagram	
namespace	urn:www.agenziaentrate.gov.it:specificheTecniche:sco:730
children	m730:DataConsegna m730:TipologiaSoggettoAssFisc m730:SostitutoCF m730:DatiCafDoc m730:DatiProfessionistaDoc m730:DatiAssociazioneDoc m730:AgenziaEntrate

element Soggetto_Assistenza_Fiscale_Doc_Type/DataConsegna

diagram					
namespace	urn:www.agenziaentrate.gov.it:specificheTecniche:sco:730				
type	DatoDT_Type				
facets	<table border="1"> <thead> <tr> <th>Kind</th> <th>Value</th> </tr> </thead> <tbody> <tr> <td>pattern</td> <td>((([0-9]{1,12}[0-9]{3,01})(0[13578][10]12)\d{4}))((([0-9]{1,9}[12][0-9]{30})(0[469][11]\d{4}))((([0-9]{1,9}[10-9]{2}[0-8])(02)\d{4}))((29)(02)([02468][048]00))((29)(02)([13579][26]00))((29)(02)([0-9][0-9][0][48]))((29)(02)([0-9][0-9][2468][048]))((29)(02)([0-9][0-9][13579][26]))))</td> </tr> </tbody> </table>	Kind	Value	pattern	((([0-9]{1,12}[0-9]{3,01})(0[13578][10]12)\d{4}))((([0-9]{1,9}[12][0-9]{30})(0[469][11]\d{4}))((([0-9]{1,9}[10-9]{2}[0-8])(02)\d{4}))((29)(02)([02468][048]00))((29)(02)([13579][26]00))((29)(02)([0-9][0-9][0][48]))((29)(02)([0-9][0-9][2468][048]))((29)(02)([0-9][0-9][13579][26]))))
Kind	Value				
pattern	((([0-9]{1,12}[0-9]{3,01})(0[13578][10]12)\d{4}))((([0-9]{1,9}[12][0-9]{30})(0[469][11]\d{4}))((([0-9]{1,9}[10-9]{2}[0-8])(02)\d{4}))((29)(02)([02468][048]00))((29)(02)([13579][26]00))((29)(02)([0-9][0-9][0][48]))((29)(02)([0-9][0-9][2468][048]))((29)(02)([0-9][0-9][13579][26]))))				

element **Soggetto_Assistenza_Fiscale_Doc_Type/TipologiaSoggettoAssFisc**

diagram															
namespace	urn:www.agenziaentrate.gov.it:specificheTecniche:sco:730														
type	m730:Tipologia_Soggetto_Ass_Fisc_Type														
facets	<table border="1"> <thead> <tr> <th>Kind</th> <th>Value</th> </tr> </thead> <tbody> <tr> <td>pattern</td> <td>[1-9]</td> </tr> <tr> <td>enumeration</td> <td>1</td> </tr> <tr> <td>enumeration</td> <td>2</td> </tr> <tr> <td>enumeration</td> <td>3</td> </tr> <tr> <td>enumeration</td> <td>4</td> </tr> <tr> <td>enumeration</td> <td>5</td> </tr> </tbody> </table>	Kind	Value	pattern	[1-9]	enumeration	1	enumeration	2	enumeration	3	enumeration	4	enumeration	5
Kind	Value														
pattern	[1-9]														
enumeration	1														
enumeration	2														
enumeration	3														
enumeration	4														
enumeration	5														

element **Soggetto_Assistenza_Fiscale_Doc_Type/SostitutoCF**

diagram					
namespace	urn:www.agenziaentrate.gov.it:specificheTecniche:sco:730				
type	DatoCF_Type				
facets	<table border="1"> <thead> <tr> <th>Kind</th> <th>Value</th> </tr> </thead> <tbody> <tr> <td>pattern</td> <td>[0-9]{11}[A-Z]{6}[0-9LMNPQRSTUVWXYZ]{2}[A-Z]{1}[0-9LMNPQRSTUVWXYZ]{2}[A-Z]{1}[0-9LMNPQRSTUVWXYZ]{3}[A-Z]{1}</td> </tr> </tbody> </table>	Kind	Value	pattern	[0-9]{11}[A-Z]{6}[0-9LMNPQRSTUVWXYZ]{2}[A-Z]{1}[0-9LMNPQRSTUVWXYZ]{2}[A-Z]{1}[0-9LMNPQRSTUVWXYZ]{3}[A-Z]{1}
Kind	Value				
pattern	[0-9]{11}[A-Z]{6}[0-9LMNPQRSTUVWXYZ]{2}[A-Z]{1}[0-9LMNPQRSTUVWXYZ]{2}[A-Z]{1}[0-9LMNPQRSTUVWXYZ]{3}[A-Z]{1}				

element **Soggetto_Assistenza_Fiscale_Doc_Type/DatiCafDoc**

diagram	
namespace	urn:www.agenziaentrate.gov.it:specificheTecniche:sco:730
type	extension of m730:Dati_CAF_Type

children	m730:CFCaf m730:DenominazioneCaf m730:NumeroAlbo m730:CFResponsabile m730:CognomeResponsabile m730:NomeResponsabile m730:CFSocServizi m730:IdSedePeriferica m730:CasellaAttestazioneCaf
----------	---

element **Soggetto_Assistenza_Fiscale_Doc_Type/DatiCafDoc/CFResponsabile**

diagram	
namespace	urn:www.agenziaentrate.gov.it:specificheTecniche:sco:730
type	DatoCF_Type
facets	Kind Value pattern [0-9]{11}[A-Z]{6}[0-9LMNPQRSTU]{2}[A-Z]{1}[0-9LMNPQRSTU]{2}[A-Z]{1}[0-9LMNPQRSTU]{3}[A-Z]{1}

element **Soggetto_Assistenza_Fiscale_Doc_Type/DatiCafDoc/CognomeResponsabile**

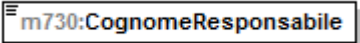
diagram	
namespace	urn:www.agenziaentrate.gov.it:specificheTecniche:sco:730
type	DatoAN_Type
facets	Kind Value pattern ([0-9A-Z\-\"]{1})([0-9A-Z&:] ' \"- \". , / ° \"\\(\\) À É È Ì Ò Ù Û " \\\"\\ \\+)*

element **Soggetto_Assistenza_Fiscale_Doc_Type/DatiCafDoc/NomeResponsabile**

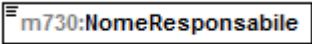
diagram	
namespace	urn:www.agenziaentrate.gov.it:specificheTecniche:sco:730
type	DatoAN_Type
facets	Kind Value pattern ([0-9A-Z\-\"]{1})([0-9A-Z&:] ' \"- \". , / ° \"\\(\\) À É È Ì Ò Ù Û " \\\"\\ \\+)*

element **Soggetto_Assistenza_Fiscale_Doc_Type/DatiCafDoc/CFSocServizi**

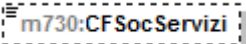
diagram	
namespace	urn:www.agenziaentrate.gov.it:specificheTecniche:sco:730
type	DatoCN_Type
facets	Kind Value pattern [0-9]{11}

element **Soggetto_Assistenza_Fiscale_Doc_Type/DatiCafDoc/IdSedePeriferica**

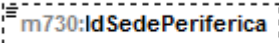
diagram	
namespace	urn:www.agenziaentrate.gov.it:specificheTecniche:sco:730

type	DatoAN_Type
facets	Kind Value pattern ([0-9A-Z\-\] \"){1}([0-9A-Z&:] \- \., / * \^ \(\) \À \É \Ì \Ò \Ù \Û \" \N \+)*

element **Soggetto_Assistenza_Fiscale_Doc_Type/DatiCafDoc/CasellaAttestazioneCaf**

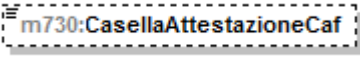
diagram	
namespace	urn:www.agenziaentrare.gov.it:specificheTecniche:sco:730
type	DatoCB_Type
facets	Kind Value pattern [01]

element **Soggetto_Assistenza_Fiscale_Doc_Type/DatiProfessionistaDoc**

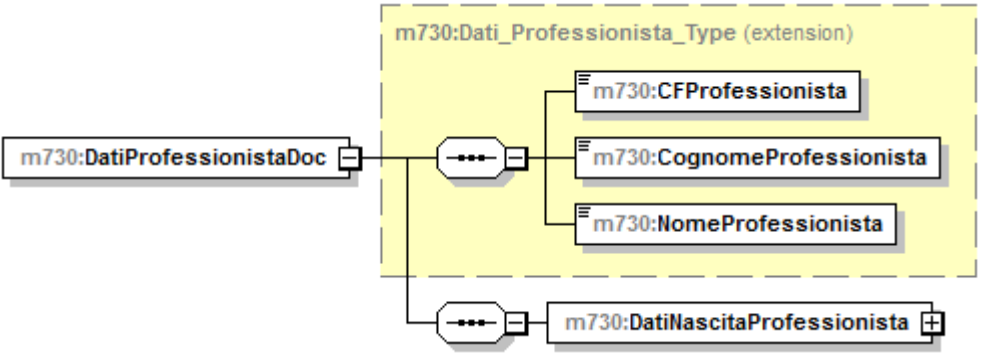
diagram	
namespace	urn:www.agenziaentrare.gov.it:specificheTecniche:sco:730
type	extension of m730:Dati_Professionista_Type
children	m730:CFProfessionista m730:CognomeProfessionista m730:NomeProfessionista m730:DatiNascitaProfessionista

element **Soggetto_Assistenza_Fiscale_Doc_Type/DatiProfessionistaDoc/DatiNascitaProfessionista**

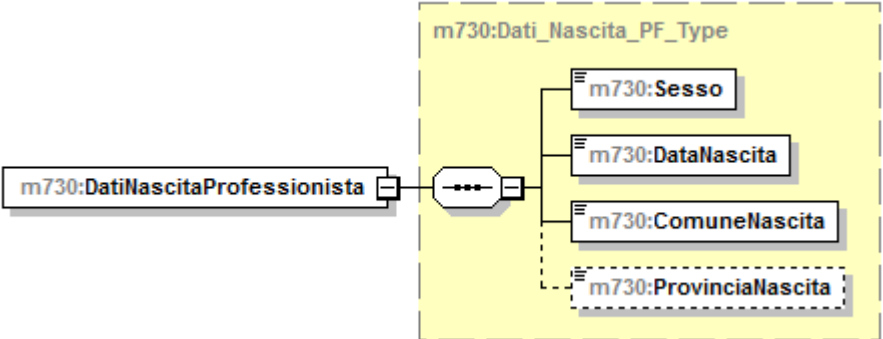
diagram	
namespace	urn:www.agenziaentrare.gov.it:specificheTecniche:sco:730
type	m730:Dati_Nascita_PF_Type

children	m730:Sesso m730:DataNascita m730:ComuneNascita m730:ProvinciaNascita
----------	--

element **Soggetto_Assistenza_Fiscale_Doc_Type/DatiAssociazioneDoc**

diagram	
namespace	urn:www.agenziaentrate.gov.it:specificheTecniche:sco:730
type	extension of m730:Dati_Associazioni_Professionale_Type
children	m730:CFAssociazione m730:DenominazioneAssociazione m730:CFProfessionista m730:CognomeProfessionista m730:NomeProfessionista m730:DatiNascitaProfessionista

element **Soggetto_Assistenza_Fiscale_Doc_Type/DatiAssociazioneDoc/DatiNascitaProfessionista**

diagram	
namespace	urn:www.agenziaentrate.gov.it:specificheTecniche:sco:730
type	m730:Dati_Nascita_PF_Type
children	m730:Sesso m730:DataNascita m730:ComuneNascita m730:ProvinciaNascita

element **Soggetto_Assistenza_Fiscale_Doc_Type/AgenziaEntrate**

diagram	
---------	--

namespace	urn:www.agenziaentrate.gov.it:specificheTecniche:sco:730	
type	DatoCB_Type	
facets	Kind	Value
	pattern	[01]

complexType **Soggetto_Fiscale_730_Type**

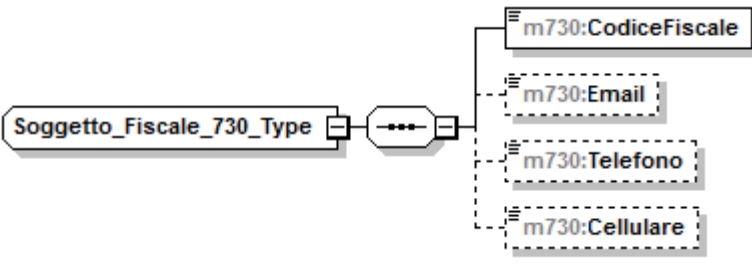
diagram		
namespace	urn:www.agenziaentrate.gov.it:specificheTecniche:sco:730	
children	m730:CodiceFiscale m730:Email m730:Telefono m730:Cellulare	

element **Soggetto_Fiscale_730_Type/CodiceFiscale**

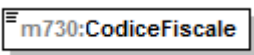
diagram		
namespace	urn:www.agenziaentrate.gov.it:specificheTecniche:sco:730	
type	DatoCF_Type	
facets	Kind	Value
	pattern	[0-9]{11}[A-Z]{6}[0-9LMNPQRSTU]{2}[A-Z]{1}[0-9LMNPQRSTU]{2}[A-Z]{1}[0-9LMNPQRSTU]{3}[A-Z]{1}

element **Soggetto_Fiscale_730_Type/Email**

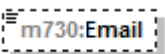
diagram		
namespace	urn:www.agenziaentrate.gov.it:specificheTecniche:sco:730	
type	DatoEM_Type	
facets	Kind	Value
	pattern	[a-zA-Z0-9._%'\"?^~=]+@[a-zA-Z0-9.\-]+\.[a-zA-Z]{2,4}

element **Soggetto_Fiscale_730_Type/Telefono**

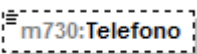
diagram		
namespace	urn:www.agenziaentrate.gov.it:specificheTecniche:sco:730	
type	DatoAN_Type	
facets	Kind	Value
	pattern	([0-9A-Z-] \"){1}([0-9A-Z&#39; \- \., / \°\^\(\)\ À É È Ì Ò Ù Û \" \ \\ \ +)*

element **Soggetto_Fiscale_730_Type/Cellulare**

diagram					
namespace	urn:www.agenziaentrate.gov.it:specificheTecniche:sco:730				
type	DatoAN_Type				
facets	<table border="1"> <tr> <td>Kind</td> <td>Value</td> </tr> <tr> <td>pattern</td> <td>([0-9A-Z\-\]&quot;){1}([0-9A-Z&amp;:] ' \" \\. / ° \\^\(\\) À É È Ì Ò Ù Û &quot; \\ \\ \\ +)*</td> </tr> </table>	Kind	Value	pattern	([0-9A-Z\-\]"){1}([0-9A-Z&:] ' \" \\. / ° \\^\(\\) À É È Ì Ò Ù Û " \\ \\ \\ +)*
Kind	Value				
pattern	([0-9A-Z\-\]"){1}([0-9A-Z&:] ' \" \\. / ° \\^\(\\) À É È Ì Ò Ù Û " \\ \\ \\ +)*				

complexType **Soglie_Esenzione_Type**

diagram	
namespace	urn:www.agenziaentrate.gov.it:specificheTecniche:sco:730
children	m730:SogliaEsenzione m730:EsenzioneTotale

element **Soglie_Esenzione_Type/SogliaEsenzione**

diagram					
namespace	urn:www.agenziaentrate.gov.it:specificheTecniche:sco:730				
type	DatoNP_Type				
facets	<table border="1"> <tr> <td>Kind</td> <td>Value</td> </tr> <tr> <td>pattern</td> <td>[1-9]{1}[0-9]*</td> </tr> </table>	Kind	Value	pattern	[1-9]{1}[0-9]*
Kind	Value				
pattern	[1-9]{1}[0-9]*				

element **Soglie_Esenzione_Type/EsenzioneTotale**

diagram									
namespace	urn:www.agenziaentrate.gov.it:specificheTecniche:sco:730								
type	restriction of DatoN1_Type								
facets	<table border="1"> <tr> <td>Kind</td> <td>Value</td> </tr> <tr> <td>pattern</td> <td>[1-9]</td> </tr> <tr> <td>enumeration</td> <td>1</td> </tr> <tr> <td>enumeration</td> <td>2</td> </tr> </table>	Kind	Value	pattern	[1-9]	enumeration	1	enumeration	2
Kind	Value								
pattern	[1-9]								
enumeration	1								
enumeration	2								

complexType **Sostituto_Type**

diagram	
namespace	urn:www.agenziaentrate.gov.it:specificheTecniche:sco:730
children	m730:CodiceFiscale m730:DatiAnagraficiPF m730:DenominazionePNF m730:Residenza m730:Fax m730:CodiceSede

element **Sostituto_Type/CodiceFiscale**

diagram					
namespace	urn:www.agenziaentrate.gov.it:specificheTecniche:sco:730				
type	DatoCF_Type				
facets	<table border="1"> <thead> <tr> <th>Kind</th> <th>Value</th> </tr> </thead> <tbody> <tr> <td>pattern</td> <td>[0-9]{11}[A-Z]{6}[0-9LMNPQRSTUUV]{2}[A-Z]{1}[0-9LMNPQRSTUUV]{2}[A-Z]{1}[0-9LMNPQRSTUUV]{3}[A-Z]{1}</td> </tr> </tbody> </table>	Kind	Value	pattern	[0-9]{11}[A-Z]{6}[0-9LMNPQRSTUUV]{2}[A-Z]{1}[0-9LMNPQRSTUUV]{2}[A-Z]{1}[0-9LMNPQRSTUUV]{3}[A-Z]{1}
Kind	Value				
pattern	[0-9]{11}[A-Z]{6}[0-9LMNPQRSTUUV]{2}[A-Z]{1}[0-9LMNPQRSTUUV]{2}[A-Z]{1}[0-9LMNPQRSTUUV]{3}[A-Z]{1}				

element **Sostituto_Type/DatiAnagraficiPF**

diagram	
namespace	urn:www.agenziaentrate.gov.it:specificheTecniche:sco:730
children	m730:Cognome m730:Nome

element **Sostituto_Type/DatiAnagraficiPF/Cognome**

diagram					
namespace	urn:www.agenziaentrate.gov.it:specificheTecniche:sco:730				
type	DatoAN_Type				
facets	<table border="1"> <thead> <tr> <th>Kind</th> <th>Value</th> </tr> </thead> <tbody> <tr> <td>pattern</td> <td>([0-9A-Z-] \&quot;){1}([0-9A-Z&amp;:] ' - \., / ° '°\(\)\ À È É Ì Ò Ù Û &quot; \ \\ \ +)*</td> </tr> </tbody> </table>	Kind	Value	pattern	([0-9A-Z-] \"){1}([0-9A-Z&:] ' - \., / ° '°\(\)\ À È É Ì Ò Ù Û " \ \\ \ +)*
Kind	Value				
pattern	([0-9A-Z-] \"){1}([0-9A-Z&:] ' - \., / ° '°\(\)\ À È É Ì Ò Ù Û " \ \\ \ +)*				

element **Sostituto_Type/DatiAnagraficiPF/Nome**

diagram	
namespace	urn:www.agenziaentrate.gov.it:specificheTecniche:sco:730
type	DatoAN_Type
facets	Kind Value pattern ([0-9A-Z-] \"){1}([0-9A-Z&] '\- \., / \^\(\ \)\ À É È Ì Ò Ù Û " \ \\ \ +)*

element **Sostituto_Type/DenominazionePNF**

diagram	
namespace	urn:www.agenziaentrate.gov.it:specificheTecniche:sco:730
type	DatoAN_Type
facets	Kind Value pattern ([0-9A-Z-] \"){1}([0-9A-Z&] '\- \., / \^\(\ \)\ À É È Ì Ò Ù Û " \ \\ \ +)*

element **Sostituto_Type/Residenza**

diagram	
namespace	urn:www.agenziaentrate.gov.it:specificheTecniche:sco:730
type	m730:Residenza_Type
children	m730:Comune m730:Provincia m730:CodiceComune m730:Cap m730:Tipologia m730:Indirizzo m730:NumCivico m730:Frazione m730:Email m730:Telefono

element **Sostituto_Type/Fax**

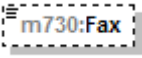
diagram	
namespace	urn:www.agenziaentrate.gov.it:specificheTecniche:sco:730
type	DatoAN_Type
facets	Kind Value pattern ([0-9A-Z\-\] "){1}([0-9A-Z&:] ' - \., / ° °\^\(\)\ À È É Ì Ò Ù Ú Û " \ \\ \ +)*

element **Sostituto_Type/CodiceSede**

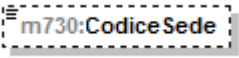
diagram	
namespace	urn:www.agenziaentrate.gov.it:specificheTecniche:sco:730
type	DatoAN_Type
facets	Kind Value pattern ([0-9A-Z\-\] "){1}([0-9A-Z&:] ' - \., / ° °\^\(\)\ À È É Ì Ò Ù Ú Û " \ \\ \ +)*

complexType **Spese_Arredo_Giovani_Coppie_Type**

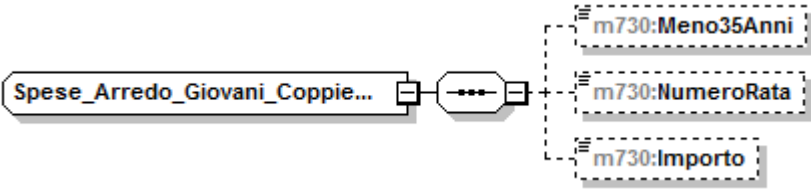
diagram	
namespace	urn:www.agenziaentrate.gov.it:specificheTecniche:sco:730
children	m730:Meno35Anni m730:NumeroRata m730:Importo

element **Spese_Arredo_Giovani_Coppie_Type/Meno35Anni**

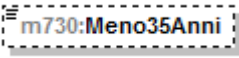
diagram	
namespace	urn:www.agenziaentrate.gov.it:specificheTecniche:sco:730
type	DatoCB_Type
facets	Kind Value pattern [01]

element **Spese_Arredo_Giovani_Coppie_Type/NumeroRata**

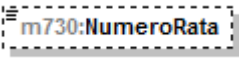
diagram	
namespace	urn:www.agenziaentrate.gov.it:specificheTecniche:sco:730

type	restriction of DatoNP_Type						
facets	<table border="1"> <tr> <td>Kind</td> <td>Value</td> </tr> <tr> <td>pattern</td> <td>[1-9]{1}[0-9]*</td> </tr> <tr> <td>enumeration</td> <td>1</td> </tr> </table>	Kind	Value	pattern	[1-9]{1}[0-9]*	enumeration	1
Kind	Value						
pattern	[1-9]{1}[0-9]*						
enumeration	1						

element **Spese_Arredo_Giovani_Coppie_Type/Importo**

diagram					
namespace	urn:www.agenziaentrate.gov.it:specificheTecniche:sco:730				
type	DatoNP_Type				
facets	<table border="1"> <tr> <td>Kind</td> <td>Value</td> </tr> <tr> <td>pattern</td> <td>[1-9]{1}[0-9]*</td> </tr> </table>	Kind	Value	pattern	[1-9]{1}[0-9]*
Kind	Value				
pattern	[1-9]{1}[0-9]*				

complexType **Spese_Arredo_Type**

diagram	
namespace	urn:www.agenziaentrate.gov.it:specificheTecniche:sco:730
children	m730:NumeroRata m730:Importo

element **Spese_Arredo_Type/NumeroRata**

diagram													
namespace	urn:www.agenziaentrate.gov.it:specificheTecniche:sco:730												
type	restriction of DatoNP_Type												
facets	<table border="1"> <tr> <td>Kind</td> <td>Value</td> </tr> <tr> <td>pattern</td> <td>[1-9]{1}[0-9]*</td> </tr> <tr> <td>enumeration</td> <td>1</td> </tr> <tr> <td>enumeration</td> <td>2</td> </tr> <tr> <td>enumeration</td> <td>3</td> </tr> <tr> <td>enumeration</td> <td>4</td> </tr> </table>	Kind	Value	pattern	[1-9]{1}[0-9]*	enumeration	1	enumeration	2	enumeration	3	enumeration	4
Kind	Value												
pattern	[1-9]{1}[0-9]*												
enumeration	1												
enumeration	2												
enumeration	3												
enumeration	4												

element **Spese_Arredo_Type/Importo**

diagram					
namespace	urn:www.agenziaentrate.gov.it:specificheTecniche:sco:730				
type	DatoNP_Type				
facets	<table border="1"> <tr> <td>Kind</td> <td>Value</td> </tr> <tr> <td>pattern</td> <td>[1-9]{1}[0-9]*</td> </tr> </table>	Kind	Value	pattern	[1-9]{1}[0-9]*
Kind	Value				
pattern	[1-9]{1}[0-9]*				

complexType Spese_Leasing_Type

diagram	
namespace	urn:www.agenziaentrate.gov.it:specificheTecniche:sco:730
children	m730:DataStipula m730:NumeroAnno m730:Canone m730:PrezzoRiscatto

element Spese_Leasing_Type/DataStipula

diagram					
namespace	urn:www.agenziaentrate.gov.it:specificheTecniche:sco:730				
type	DatoDT_Type				
facets	<table border="1"> <thead> <tr> <th>Kind</th> <th>Value</th> </tr> </thead> <tbody> <tr> <td>pattern</td> <td>((([0-9]{1,12}[0-9]{3,10})(0[13578]1012\d{4})) ((([0-9]{1,12}[0-9]{30}0[469]11)\d{4})) ((([0-9]{1,2}[0-8])(02\d{4})) ((29)(02)[02468][048]00)) ((29)(02)[13579][26]00)) ((29)(02)[0-9][0148]) ((29)(02)[0-9][0-9][2468][048]) ((29)(02)[0-9][13579][26]))</td> </tr> </tbody> </table>	Kind	Value	pattern	((([0-9]{1,12}[0-9]{3,10})(0[13578]1012\d{4})) ((([0-9]{1,12}[0-9]{30}0[469]11)\d{4})) ((([0-9]{1,2}[0-8])(02\d{4})) ((29)(02)[02468][048]00)) ((29)(02)[13579][26]00)) ((29)(02)[0-9][0148]) ((29)(02)[0-9][0-9][2468][048]) ((29)(02)[0-9][13579][26]))
Kind	Value				
pattern	((([0-9]{1,12}[0-9]{3,10})(0[13578]1012\d{4})) ((([0-9]{1,12}[0-9]{30}0[469]11)\d{4})) ((([0-9]{1,2}[0-8])(02\d{4})) ((29)(02)[02468][048]00)) ((29)(02)[13579][26]00)) ((29)(02)[0-9][0148]) ((29)(02)[0-9][0-9][2468][048]) ((29)(02)[0-9][13579][26]))				

element Spese_Leasing_Type/NumeroAnno

diagram							
namespace	urn:www.agenziaentrate.gov.it:specificheTecniche:sco:730						
type	restriction of DatoNP_Type						
facets	<table border="1"> <thead> <tr> <th>Kind</th> <th>Value</th> </tr> </thead> <tbody> <tr> <td>pattern</td> <td>[1-9]{1}[0-9]*</td> </tr> <tr> <td>enumeration</td> <td>1</td> </tr> </tbody> </table>	Kind	Value	pattern	[1-9]{1}[0-9]*	enumeration	1
Kind	Value						
pattern	[1-9]{1}[0-9]*						
enumeration	1						

element Spese_Leasing_Type/Canone

diagram					
namespace	urn:www.agenziaentrate.gov.it:specificheTecniche:sco:730				
type	restriction of DatoNP_Type				
facets	<table border="1"> <thead> <tr> <th>Kind</th> <th>Value</th> </tr> </thead> <tbody> <tr> <td>pattern</td> <td>[1-9]{1}[0-9]*</td> </tr> </tbody> </table>	Kind	Value	pattern	[1-9]{1}[0-9]*
Kind	Value				
pattern	[1-9]{1}[0-9]*				

element **Spese_Leasing_Type/PrezzoRiscatto**

diagram	
namespace	urn:www.agenziaentrate.gov.it:specificheTecniche:sco:730
type	restriction of DatoNP_Type
facets	Kind Value pattern [1-9]{1}[0-9]*

complexType **Spese_Rateizzate_Anni_Precedenti_Type**

diagram	
namespace	urn:www.agenziaentrate.gov.it:specificheTecniche:sco:730
children	m730:Codice m730:Importo

element **Spese_Rateizzate_Anni_Precedenti_Type/Codice**

diagram	
namespace	urn:www.agenziaentrate.gov.it:specificheTecniche:sco:730
type	m730:Codice Spese_Rateizzate_Anni_Precedenti_Type
facets	Kind Value pattern [1-9]{1}[0-9]* enumeration 2 enumeration 3 enumeration 4

element **Spese_Rateizzate_Anni_Precedenti_Type/Importo**

diagram	
namespace	urn:www.agenziaentrate.gov.it:specificheTecniche:sco:730
type	DatoNP_Type
facets	Kind Value pattern [1-9]{1}[0-9]*

complexType **Spese_Rateizzate_Type**

diagram	
namespace	urn:www.agenziaentrate.gov.it:specificheTecniche:sco:730

children	m730:Codice m730:Importo
----------	--

element **Spese_Rateizzate_Type/Codice**

diagram													
namespace	urn:www.agenziaentrate.gov.it:specificheTecniche:sco:730												
type	m730:Codice Spese Rateizzate Type												
facets	<table border="1"> <thead> <tr> <th>Kind</th> <th>Value</th> </tr> </thead> <tbody> <tr> <td>pattern</td> <td>[1-9]{1}[0-9]*</td> </tr> <tr> <td>enumeration</td> <td>1</td> </tr> <tr> <td>enumeration</td> <td>2</td> </tr> <tr> <td>enumeration</td> <td>3</td> </tr> <tr> <td>enumeration</td> <td>4</td> </tr> </tbody> </table>	Kind	Value	pattern	[1-9]{1}[0-9]*	enumeration	1	enumeration	2	enumeration	3	enumeration	4
Kind	Value												
pattern	[1-9]{1}[0-9]*												
enumeration	1												
enumeration	2												
enumeration	3												
enumeration	4												

element **Spese_Rateizzate_Type/Importo**

diagram					
namespace	urn:www.agenziaentrate.gov.it:specificheTecniche:sco:730				
type	DatoNP_Type				
facets	<table border="1"> <thead> <tr> <th>Kind</th> <th>Value</th> </tr> </thead> <tbody> <tr> <td>pattern</td> <td>[1-9]{1}[0-9]*</td> </tr> </tbody> </table>	Kind	Value	pattern	[1-9]{1}[0-9]*
Kind	Value				
pattern	[1-9]{1}[0-9]*				

complexType **Tassazione_Separata_Type**

diagram	
namespace	urn:www.agenziaentrate.gov.it:specificheTecniche:sco:730
children	m730:Opzione m730:Anno m730:RedditoRitenute

element **Tassazione_Separata_Type/Opzione**

diagram					
namespace	urn:www.agenziaentrate.gov.it:specificheTecniche:sco:730				
type	DatoCB_Type				
facets	<table border="1"> <thead> <tr> <th>Kind</th> <th>Value</th> </tr> </thead> <tbody> <tr> <td>pattern</td> <td>[01]</td> </tr> </tbody> </table>	Kind	Value	pattern	[01]
Kind	Value				
pattern	[01]				

element **Tassazione_Separata_Type/Anno**

diagram	
namespace	urn:www.agenziaentrate.gov.it:specificheTecniche:sco:730
type	DatoDA_Type
facets	Kind Value pattern (18 19 20){0-9}{2}

element **Tassazione_Separata_Type/RedditoRitenute**

diagram	
namespace	urn:www.agenziaentrate.gov.it:specificheTecniche:sco:730
type	m730:Redditi_Ritenute_Type
children	m730:ImportoRedditi m730:ImportoRitenute

complexType **Terreno_Type**

diagram	
namespace	urn:www.agenziaentrate.gov.it:specificheTecniche:sco:730
children	m730:RedDominicale m730:Titolo m730:RedAgrario m730:GiorniPossesso m730:PercPossesso m730:CanoneVincolistico m730:CasiParticolari m730:CasellaContinuazione m730:CasellaImmuNonDovuta m730:CasellaColtivatoreDiretto

element **Terreno_Type/RedDominicale**

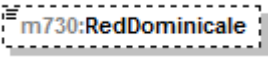
diagram					
namespace	urn:www.agenziaentrate.gov.it:specificheTecniche:sco:730				
type	DatoNP_Type				
facets	<table border="1"> <thead> <tr> <th>Kind</th> <th>Value</th> </tr> </thead> <tbody> <tr> <td>pattern</td> <td>[1-9]{1}[0-9]*</td> </tr> </tbody> </table>	Kind	Value	pattern	[1-9]{1}[0-9]*
Kind	Value				
pattern	[1-9]{1}[0-9]*				

element **Terreno_Type/Titolo**

diagram																					
namespace	urn:www.agenziaentrate.gov.it:specificheTecniche:sco:730																				
type	m730:Titolo_Terreno_Type																				
facets	<table border="1"> <thead> <tr> <th>Kind</th> <th>Value</th> </tr> </thead> <tbody> <tr> <td>pattern</td> <td>[1-9]{1}[0-9]*</td> </tr> <tr> <td>enumeration</td> <td>1</td> </tr> <tr> <td>enumeration</td> <td>2</td> </tr> <tr> <td>enumeration</td> <td>3</td> </tr> <tr> <td>enumeration</td> <td>4</td> </tr> <tr> <td>enumeration</td> <td>5</td> </tr> <tr> <td>enumeration</td> <td>6</td> </tr> <tr> <td>enumeration</td> <td>7</td> </tr> <tr> <td>enumeration</td> <td>10</td> </tr> </tbody> </table>	Kind	Value	pattern	[1-9]{1}[0-9]*	enumeration	1	enumeration	2	enumeration	3	enumeration	4	enumeration	5	enumeration	6	enumeration	7	enumeration	10
Kind	Value																				
pattern	[1-9]{1}[0-9]*																				
enumeration	1																				
enumeration	2																				
enumeration	3																				
enumeration	4																				
enumeration	5																				
enumeration	6																				
enumeration	7																				
enumeration	10																				

element **Terreno_Type/RedAgrario**

diagram					
namespace	urn:www.agenziaentrate.gov.it:specificheTecniche:sco:730				
type	DatoNP_Type				
facets	<table border="1"> <thead> <tr> <th>Kind</th> <th>Value</th> </tr> </thead> <tbody> <tr> <td>pattern</td> <td>[1-9]{1}[0-9]*</td> </tr> </tbody> </table>	Kind	Value	pattern	[1-9]{1}[0-9]*
Kind	Value				
pattern	[1-9]{1}[0-9]*				

element **Terreno_Type/GiorniPossesso**

diagram					
namespace	urn:www.agenziaentrate.gov.it:specificheTecniche:sco:730				
type	DatoGA_Type				
facets	<table border="1"> <thead> <tr> <th>Kind</th> <th>Value</th> </tr> </thead> <tbody> <tr> <td>pattern</td> <td>[1-9](((1-9)[0-9]) ((12)[0-9][0-9]) (3[0-5][0-9]) (36[0-5]))</td> </tr> </tbody> </table>	Kind	Value	pattern	[1-9](((1-9)[0-9]) ((12)[0-9][0-9]) (3[0-5][0-9]) (36[0-5]))
Kind	Value				
pattern	[1-9](((1-9)[0-9]) ((12)[0-9][0-9]) (3[0-5][0-9]) (36[0-5]))				

element Terreno_Type/PercPossesso

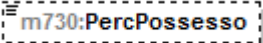
diagram					
namespace	urn:www.agenziaentrate.gov.it:specificheTecniche:sco:730				
type	DatoPC_Type				
facets	<table border="0"> <tr> <td>Kind</td> <td>Value</td> </tr> <tr> <td>pattern</td> <td>[0-9]?[0-9](,\d{1,3})? 100,0{1,3}?</td> </tr> </table>	Kind	Value	pattern	[0-9]?[0-9](,\d{1,3})? 100,0{1,3}?
Kind	Value				
pattern	[0-9]?[0-9](,\d{1,3})? 100,0{1,3}?				

element Terreno_Type/CanoneVincolistico

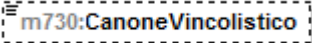
diagram					
namespace	urn:www.agenziaentrate.gov.it:specificheTecniche:sco:730				
type	DatoNP_Type				
facets	<table border="0"> <tr> <td>Kind</td> <td>Value</td> </tr> <tr> <td>pattern</td> <td>[1-9]{1}[0-9]*</td> </tr> </table>	Kind	Value	pattern	[1-9]{1}[0-9]*
Kind	Value				
pattern	[1-9]{1}[0-9]*				

element Terreno_Type/CasiParticolari

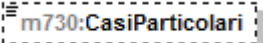
diagram													
namespace	urn:www.agenziaentrate.gov.it:specificheTecniche:sco:730												
type	m730:Casi_Particolari_Terreni_Type												
facets	<table border="0"> <tr> <td>Kind</td> <td>Value</td> </tr> <tr> <td>pattern</td> <td>[1-9]</td> </tr> <tr> <td>enumeration</td> <td>2</td> </tr> <tr> <td>enumeration</td> <td>3</td> </tr> <tr> <td>enumeration</td> <td>4</td> </tr> <tr> <td>enumeration</td> <td>6</td> </tr> </table>	Kind	Value	pattern	[1-9]	enumeration	2	enumeration	3	enumeration	4	enumeration	6
Kind	Value												
pattern	[1-9]												
enumeration	2												
enumeration	3												
enumeration	4												
enumeration	6												

element Terreno_Type/CasellaContinuazione

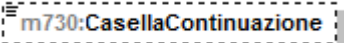
diagram					
namespace	urn:www.agenziaentrate.gov.it:specificheTecniche:sco:730				
type	DatoCB_Type				
facets	<table border="0"> <tr> <td>Kind</td> <td>Value</td> </tr> <tr> <td>pattern</td> <td>[01]</td> </tr> </table>	Kind	Value	pattern	[01]
Kind	Value				
pattern	[01]				

element Terreno_Type/CasellalmuNonDovuta

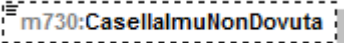
diagram	
namespace	urn:www.agenziaentrate.gov.it:specificheTecniche:sco:730
type	DatoCB_Type

facets	Kind	Value
	pattern	[01]

element **Terreno_Type/CasellaColtivatoreDiretto**

diagram		
namespace	urn:www.agenziaentrato.gov.it:specificheTecniche:sco:730	
type	DatoCB_Type	
facets	Kind	Value
	pattern	[01]

complexType **Versamenti_F24_Type**

<p>diagram</p>	
<p>namespace</p>	<p>urn:www.agenziaentrate.gov.it:specificheTecniche:sco:730</p>
<p>children</p>	<p>m730:F24DebitoIrpef m730:F24DebitoCodRegione m730:F24DebitoAddReg m730:F24DebitoCodComune m730:F24DebitoAddCom m730:F24DebitoPrimaRataAcclrpef m730:F24DebitoAccontoTassSep m730:F24DebitoCodComuneAcconto m730:F24DebitoAccontoAddCom m730:F24DebitoImpostaSost m730:F24DebitoCedolare m730:F24DebitoPrimaRataAccCedolare m730:F24DebitoContribSolidarieta m730:F24DebitoCodRegioneConiuge m730:F24DebitoAddRegConiuge m730:F24DebitoCodComuneConiuge m730:F24DebitoAddComConiuge m730:F24DebitoCodComuneAccontoConiuge m730:F24DebitoAccontoAddComConiuge m730:F24DebitoSecondaRataAcclrpef</p>

element **Versamenti_F24_Type/F24DebitoCodComune**

diagram	 m730:F24DebitoCodComune				
namespace	urn:www.agenziaentrate.gov.it:specificheTecniche:sco:730				
type	DatoAN_Type				
facets	<table border="1"> <tr> <td>Kind</td> <td>Value</td> </tr> <tr> <td>pattern</td> <td>(([0-9A-Z\-\] \&quot;){1}([0-9A-Z&amp;] " \- \., / "^\(\)\) À É È Ì Ò Ù Û &quot; \N \\ +)*</td> </tr> </table>	Kind	Value	pattern	(([0-9A-Z\-\] \"){1}([0-9A-Z&] " \- \., / "^\(\)\) À É È Ì Ò Ù Û " \N \\ +)*
Kind	Value				
pattern	(([0-9A-Z\-\] \"){1}([0-9A-Z&] " \- \., / "^\(\)\) À É È Ì Ò Ù Û " \N \\ +)*				

element **Versamenti_F24_Type/F24DebitoAddCom**

diagram	 m730:F24DebitoAddCom				
namespace	urn:www.agenziaentrate.gov.it:specificheTecniche:sco:730				
type	DatoNP_Type				
facets	<table border="1"> <tr> <td>Kind</td> <td>Value</td> </tr> <tr> <td>pattern</td> <td>[1-9]{1}[0-9]*</td> </tr> </table>	Kind	Value	pattern	[1-9]{1}[0-9]*
Kind	Value				
pattern	[1-9]{1}[0-9]*				

element **Versamenti_F24_Type/F24DebitoPrimaRataAcclrpef**

diagram	 m730:F24DebitoPrimaRataAcclrpef				
namespace	urn:www.agenziaentrate.gov.it:specificheTecniche:sco:730				
type	DatoNP_Type				
facets	<table border="1"> <tr> <td>Kind</td> <td>Value</td> </tr> <tr> <td>pattern</td> <td>[1-9]{1}[0-9]*</td> </tr> </table>	Kind	Value	pattern	[1-9]{1}[0-9]*
Kind	Value				
pattern	[1-9]{1}[0-9]*				

element **Versamenti_F24_Type/F24DebitoAccontoTassSep**

diagram	 m730:F24DebitoAccontoTass Sep				
namespace	urn:www.agenziaentrate.gov.it:specificheTecniche:sco:730				
type	DatoNP_Type				
facets	<table border="1"> <tr> <td>Kind</td> <td>Value</td> </tr> <tr> <td>pattern</td> <td>[1-9]{1}[0-9]*</td> </tr> </table>	Kind	Value	pattern	[1-9]{1}[0-9]*
Kind	Value				
pattern	[1-9]{1}[0-9]*				

element **Versamenti_F24_Type/F24DebitoCodComuneAcconto**

diagram	 m730:F24DebitoCodComuneAcc...				
namespace	urn:www.agenziaentrate.gov.it:specificheTecniche:sco:730				
type	DatoAN_Type				
facets	<table border="1"> <tr> <td>Kind</td> <td>Value</td> </tr> <tr> <td>pattern</td> <td>(([0-9A-Z\-\] \&quot;){1}([0-9A-Z&amp;] " \- \., / "^\(\)\) À É È Ì Ò Ù Û &quot; \N \\ +)*</td> </tr> </table>	Kind	Value	pattern	(([0-9A-Z\-\] \"){1}([0-9A-Z&] " \- \., / "^\(\)\) À É È Ì Ò Ù Û " \N \\ +)*
Kind	Value				
pattern	(([0-9A-Z\-\] \"){1}([0-9A-Z&] " \- \., / "^\(\)\) À É È Ì Ò Ù Û " \N \\ +)*				

element **Versamenti_F24_Type/F24DebitoAccontoAddCom**

diagram	 m730:F24DebitoAccontoAddCom
namespace	urn:www.agenziaentrate.gov.it:specificheTecniche:sco:730
type	DatoNP_Type
facets	Kind Value pattern [1-9]{1}[0-9]*

element **Versamenti_F24_Type/F24DebitoImpostaSost**

diagram	 m730:F24DebitoImpostaSost
namespace	urn:www.agenziaentrate.gov.it:specificheTecniche:sco:730
type	DatoNP_Type
facets	Kind Value pattern [1-9]{1}[0-9]*

element **Versamenti_F24_Type/F24DebitoCedolare**

diagram	 m730:F24DebitoCedolare
namespace	urn:www.agenziaentrate.gov.it:specificheTecniche:sco:730
type	DatoNP_Type
facets	Kind Value pattern [1-9]{1}[0-9]*

element **Versamenti_F24_Type/F24DebitoPrimaRataAccCedolare**

diagram	 m730:F24DebitoPrimaRataAccCe...
namespace	urn:www.agenziaentrate.gov.it:specificheTecniche:sco:730
type	DatoNP_Type
facets	Kind Value pattern [1-9]{1}[0-9]*

element **Versamenti_F24_Type/F24DebitoContribSolidarieta**

diagram	 m730:F24DebitoContribSolidarieta
namespace	urn:www.agenziaentrate.gov.it:specificheTecniche:sco:730
type	DatoNP_Type
facets	Kind Value pattern [1-9]{1}[0-9]*

element **Versamenti_F24_Type/F24DebitoCodRegioneConiuge**

diagram	 m730:F24DebitoCodRegioneConi...																																														
namespace	urn:www.agenziaentrate.gov.it:specificheTecniche:sco:730																																														
type	Codice Regione Type																																														
facets	<table border="1"> <thead> <tr> <th>Kind</th> <th>Value</th> </tr> </thead> <tbody> <tr> <td>pattern</td> <td>(([0-9A-Z\-\]]&quot;){1}([0-9A-Z&amp;]] \- \., / \^\ \(\ \)\) À É È Ì Ò Ù Ü &quot; \ \ \ +)*</td> </tr> <tr><td>enumeration</td><td>1</td></tr> <tr><td>enumeration</td><td>2</td></tr> <tr><td>enumeration</td><td>3</td></tr> <tr><td>enumeration</td><td>4</td></tr> <tr><td>enumeration</td><td>5</td></tr> <tr><td>enumeration</td><td>6</td></tr> <tr><td>enumeration</td><td>7</td></tr> <tr><td>enumeration</td><td>8</td></tr> <tr><td>enumeration</td><td>9</td></tr> <tr><td>enumeration</td><td>10</td></tr> <tr><td>enumeration</td><td>11</td></tr> <tr><td>enumeration</td><td>12</td></tr> <tr><td>enumeration</td><td>13</td></tr> <tr><td>enumeration</td><td>14</td></tr> <tr><td>enumeration</td><td>15</td></tr> <tr><td>enumeration</td><td>16</td></tr> <tr><td>enumeration</td><td>17</td></tr> <tr><td>enumeration</td><td>18</td></tr> <tr><td>enumeration</td><td>19</td></tr> <tr><td>enumeration</td><td>20</td></tr> <tr><td>enumeration</td><td>21</td></tr> </tbody> </table>	Kind	Value	pattern	(([0-9A-Z\-\]]"){1}([0-9A-Z&]] \- \., / \^\ \(\ \)\) À É È Ì Ò Ù Ü " \ \ \ +)*	enumeration	1	enumeration	2	enumeration	3	enumeration	4	enumeration	5	enumeration	6	enumeration	7	enumeration	8	enumeration	9	enumeration	10	enumeration	11	enumeration	12	enumeration	13	enumeration	14	enumeration	15	enumeration	16	enumeration	17	enumeration	18	enumeration	19	enumeration	20	enumeration	21
Kind	Value																																														
pattern	(([0-9A-Z\-\]]"){1}([0-9A-Z&]] \- \., / \^\ \(\ \)\) À É È Ì Ò Ù Ü " \ \ \ +)*																																														
enumeration	1																																														
enumeration	2																																														
enumeration	3																																														
enumeration	4																																														
enumeration	5																																														
enumeration	6																																														
enumeration	7																																														
enumeration	8																																														
enumeration	9																																														
enumeration	10																																														
enumeration	11																																														
enumeration	12																																														
enumeration	13																																														
enumeration	14																																														
enumeration	15																																														
enumeration	16																																														
enumeration	17																																														
enumeration	18																																														
enumeration	19																																														
enumeration	20																																														
enumeration	21																																														

element **Versamenti_F24_Type/F24DebitoAddRegConiuge**

diagram	 m730:F24DebitoAddRegConiuge				
namespace	urn:www.agenziaentrate.gov.it:specificheTecniche:sco:730				
type	DatoNP Type				
facets	<table border="1"> <thead> <tr> <th>Kind</th> <th>Value</th> </tr> </thead> <tbody> <tr> <td>pattern</td> <td>[1-9]{1}[0-9]*</td> </tr> </tbody> </table>	Kind	Value	pattern	[1-9]{1}[0-9]*
Kind	Value				
pattern	[1-9]{1}[0-9]*				

element **Versamenti_F24_Type/F24DebitoCodComuneConiuge**

diagram	 m730:F24DebitoCodComuneCon...				
namespace	urn:www.agenziaentrate.gov.it:specificheTecniche:sco:730				
type	DatoAN Type				
facets	<table border="1"> <thead> <tr> <th>Kind</th> <th>Value</th> </tr> </thead> <tbody> <tr> <td>pattern</td> <td>(([0-9A-Z\-\]]&quot;){1}([0-9A-Z&amp;]] \- \., / \^\ \(\ \)\) À É È Ì Ò Ù Ü &quot; \ \ \ +)*</td> </tr> </tbody> </table>	Kind	Value	pattern	(([0-9A-Z\-\]]"){1}([0-9A-Z&]] \- \., / \^\ \(\ \)\) À É È Ì Ò Ù Ü " \ \ \ +)*
Kind	Value				
pattern	(([0-9A-Z\-\]]"){1}([0-9A-Z&]] \- \., / \^\ \(\ \)\) À É È Ì Ò Ù Ü " \ \ \ +)*				

element **Versamenti_F24_Type/F24DebitoAddComConiuge**

diagram	 m730:F24DebitoAddComConiuge
namespace	urn:www.agenziaentrate.gov.it:specificheTecniche:sco:730
type	DatoNP_Type
facets	Kind Value pattern [1-9]{1}[0-9]*

element **Versamenti_F24_Type/F24DebitoCodComuneAccontoConiuge**

diagram	 m730:F24DebitoCodComuneAcc...
namespace	urn:www.agenziaentrate.gov.it:specificheTecniche:sco:730
type	DatoAN_Type
facets	Kind Value pattern ([0-9A-Z-] \"){1}([0-9A-Z&:] \- \., / \° \^ \(\) \À \É \È \Ì \Ò \Ù \Ü \" \ \\ \ +)*

element **Versamenti_F24_Type/F24DebitoAccontoAddComConiuge**

diagram	 m730:F24DebitoAccontoAddCo...
namespace	urn:www.agenziaentrate.gov.it:specificheTecniche:sco:730
type	DatoNP_Type
facets	Kind Value pattern [1-9]{1}[0-9]*

element **Versamenti_F24_Type/F24DebitoSecondaRataAcclrpef**

diagram	 m730:F24DebitoSecondaRataAcc...
namespace	urn:www.agenziaentrate.gov.it:specificheTecniche:sco:730
type	DatoNP_Type
facets	Kind Value pattern [1-9]{1}[0-9]*

element **Versamenti_F24_Type/F24DebitoSecondaRataAccCedolare**

diagram	 m730:F24DebitoSecondaRataAcc...
namespace	urn:www.agenziaentrate.gov.it:specificheTecniche:sco:730
type	DatoNP_Type
facets	Kind Value pattern [1-9]{1}[0-9]*

element Documento

diagram					
namespace	urn:www.agenziaentrate.gov.it:specificheTecniche:common				
type	Documento_Type				
attributes	Name	Type	Use	Default	Fixed
	identificativo	Identificativo_Type	required		

complexType Documento_Type

diagram					
namespace	urn:www.agenziaentrate.gov.it:specificheTecniche:common				
attributes	Name	Type	Use	Default	Fixed
	identificativo	Identificativo_Type	required		

attribute Documento_Type/@identificativo

type	Identificativo_Type				
facets	Kind	Value			
	pattern	[0-9]{4}[1-9] [0-9]{3}[1-9][0-9] [0-9]{2}[1-9][0-9]{2} [0-9][1-9][0-9]{3} [1-9][0-9]{4}			

simpleType Identificativo_Type

namespace	urn:www.agenziaentrate.gov.it:specificheTecniche:common				
type	restriction of xs:string				
facets	Kind	Value			
	pattern	[0-9]{4}[1-9] [0-9]{3}[1-9][0-9] [0-9]{2}[1-9][0-9]{2} [0-9][1-9][0-9]{3} [1-9][0-9]{4}			

simpleType Anno_Anticipazione_Fondo_Pensione_Type

namespace	urn:www.agenziaentrate.gov.it:specificheTecniche:sco:730				
type	restriction of DatoNP_Type				
facets	Kind	Value			
	pattern	[1-9]{1}[0-9]*			
	enumeration	2007			
	enumeration	2008			
	enumeration	2009			
	enumeration	2010			

	enumeration	2011
	enumeration	2012
	enumeration	2013
	enumeration	2014
	enumeration	2015
	enumeration	2016

simpleType Anno_Ricupero_Patrimonio_Edilizio_Type

namespace	urn:www.agenziaentrate.gov.it:specificheTecniche:sco:730	
type	restriction of DatoNP_Type	
facets	Kind	Value
	pattern	[1-9]{1}[0-9]*
	enumeration	2007
	enumeration	2008
	enumeration	2009
	enumeration	2010
	enumeration	2011
	enumeration	2012
	enumeration	2013
	enumeration	2014
	enumeration	2015
	enumeration	2016

simpleType Anno_Risparmio_Energetico_Type

namespace	urn:www.agenziaentrate.gov.it:specificheTecniche:sco:730	
type	restriction of DatoNP_Type	
facets	Kind	Value
	pattern	[1-9]{1}[0-9]*
	enumeration	2008
	enumeration	2011
	enumeration	2012
	enumeration	2013
	enumeration	2014
	enumeration	2015
	enumeration	2016

simpleType Casi_Particolari_Fabbricato_Type

namespace	urn:www.agenziaentrate.gov.it:specificheTecniche:sco:730	
type	restriction of DatoN1_Type	
facets	Kind	Value
	pattern	[1-9]
	enumeration	1
	enumeration	3
	enumeration	4
	enumeration	5

simpleType Casi_Particolari_Risp_Ener_Type

namespace	urn:www.agenziaentrate.gov.it:specificheTecniche:sco:730	
type	restriction of DatoN1_Type	
facets	Kind	Value
	pattern	[1-9]
	enumeration	1

	enumeration	2
	enumeration	3

simpleType **Casi_Particolari_Terreni_Type**

namespace	urn:www.agenziaentrate.gov.it:specificheTecniche:sco:730	
type	restriction of DatoN1_Type	
facets	Kind	Value
	pattern	[1-9]
	enumeration	2
	enumeration	3
	enumeration	4
	enumeration	6

simpleType **Codice_Altre_Detrazioni_Type**

namespace	urn:www.agenziaentrate.gov.it:specificheTecniche:sco:730	
type	restriction of DatoNP_Type	
facets	Kind	Value
	pattern	[1-9]{1}[0-9]*
	enumeration	1
	enumeration	2

simpleType **Codice_Altre_Spese_Type**

namespace	urn:www.agenziaentrate.gov.it:specificheTecniche:sco:730	
type	restriction of DatoNP_Type	
facets	Kind	Value
	pattern	[1-9]{1}[0-9]*
	enumeration	8
	enumeration	9
	enumeration	10
	enumeration	11
	enumeration	12
	enumeration	13
	enumeration	14
	enumeration	15
	enumeration	16
	enumeration	17
	enumeration	18
	enumeration	20
	enumeration	21
	enumeration	22
	enumeration	23
	enumeration	24
	enumeration	25
	enumeration	26
	enumeration	27
	enumeration	28
	enumeration	29
	enumeration	30
	enumeration	31
	enumeration	32
	enumeration	33
	enumeration	35
	enumeration	36
	enumeration	38
	enumeration	39
	enumeration	41

	enumeration	42
	enumeration	99

simpleType **Codice_Altri_Oneri_Type**

namespace	urn:www.agenziaentrate.gov.it:specificheTecniche:sco:730	
type	restriction of DatoNP_Type	
facets	Kind	Value
	pattern	[1-9]{1}[0-9]*
	enumeration	6
	enumeration	7
	enumeration	8
	enumeration	9
	enumeration	12
	enumeration	13
	enumeration	21

simpleType **Codice_Canone_Type**

namespace	urn:www.agenziaentrate.gov.it:specificheTecniche:sco:730	
type	restriction of DatoN1_Type	
facets	Kind	Value
	pattern	[1-9]
	enumeration	1
	enumeration	2
	enumeration	3
	enumeration	4

simpleType **Codice_Evento_Eccezionale_Type**

namespace	urn:www.agenziaentrate.gov.it:specificheTecniche:sco:730	
type	restriction of DatoNP_Type	
facets	Kind	Value
	pattern	[1-9]{1}[0-9]*
	enumeration	1
	enumeration	2
	enumeration	3
	enumeration	4
	enumeration	5
	enumeration	6

simpleType **Codice_Spese_Rateizzate_Anni_Precedenti_Type**

namespace	urn:www.agenziaentrate.gov.it:specificheTecniche:sco:730	
type	restriction of DatoNP_Type	
facets	Kind	Value
	pattern	[1-9]{1}[0-9]*
	enumeration	2
	enumeration	3
	enumeration	4

simpleType **Codice_Spese_Rateizzate_Type**

namespace	urn:www.agenziaentrate.gov.it:specificheTecniche:sco:730	
-----------	--	--

type	restriction of DatoNP_Type												
facets	<table border="1"> <thead> <tr> <th>Kind</th> <th>Value</th> </tr> </thead> <tbody> <tr> <td>pattern</td> <td>[1-9]{1}[0-9]*</td> </tr> <tr> <td>enumeration</td> <td>1</td> </tr> <tr> <td>enumeration</td> <td>2</td> </tr> <tr> <td>enumeration</td> <td>3</td> </tr> <tr> <td>enumeration</td> <td>4</td> </tr> </tbody> </table>	Kind	Value	pattern	[1-9]{1}[0-9]*	enumeration	1	enumeration	2	enumeration	3	enumeration	4
Kind	Value												
pattern	[1-9]{1}[0-9]*												
enumeration	1												
enumeration	2												
enumeration	3												
enumeration	4												

simpleType [Fabbricato_Agev_Numero_Rigo_Type](#)

namespace	urn:www.agenziaentrate.gov.it:specificheTecniche:sco:730																								
type	restriction of DatoNP_Type																								
facets	<table border="1"> <thead> <tr> <th>Kind</th> <th>Value</th> </tr> </thead> <tbody> <tr> <td>pattern</td> <td>[1-9]{1}[0-9]*</td> </tr> <tr> <td>enumeration</td> <td>1</td> </tr> <tr> <td>enumeration</td> <td>2</td> </tr> <tr> <td>enumeration</td> <td>3</td> </tr> <tr> <td>enumeration</td> <td>4</td> </tr> <tr> <td>enumeration</td> <td>5</td> </tr> <tr> <td>enumeration</td> <td>6</td> </tr> <tr> <td>enumeration</td> <td>7</td> </tr> <tr> <td>enumeration</td> <td>8</td> </tr> <tr> <td>enumeration</td> <td>9</td> </tr> <tr> <td>enumeration</td> <td>10</td> </tr> </tbody> </table>	Kind	Value	pattern	[1-9]{1}[0-9]*	enumeration	1	enumeration	2	enumeration	3	enumeration	4	enumeration	5	enumeration	6	enumeration	7	enumeration	8	enumeration	9	enumeration	10
Kind	Value																								
pattern	[1-9]{1}[0-9]*																								
enumeration	1																								
enumeration	2																								
enumeration	3																								
enumeration	4																								
enumeration	5																								
enumeration	6																								
enumeration	7																								
enumeration	8																								
enumeration	9																								
enumeration	10																								

simpleType [Indeterminato_Determinato_Type](#)

namespace	urn:www.agenziaentrate.gov.it:specificheTecniche:sco:730								
type	restriction of DatoN1_Type								
facets	<table border="1"> <thead> <tr> <th>Kind</th> <th>Value</th> </tr> </thead> <tbody> <tr> <td>pattern</td> <td>[1-9]</td> </tr> <tr> <td>enumeration</td> <td>1</td> </tr> <tr> <td>enumeration</td> <td>2</td> </tr> </tbody> </table>	Kind	Value	pattern	[1-9]	enumeration	1	enumeration	2
Kind	Value								
pattern	[1-9]								
enumeration	1								
enumeration	2								

simpleType [Integrativo_Type](#)

namespace	urn:www.agenziaentrate.gov.it:specificheTecniche:sco:730										
type	restriction of DatoN1_Type										
facets	<table border="1"> <thead> <tr> <th>Kind</th> <th>Value</th> </tr> </thead> <tbody> <tr> <td>pattern</td> <td>[1-9]</td> </tr> <tr> <td>enumeration</td> <td>1</td> </tr> <tr> <td>enumeration</td> <td>2</td> </tr> <tr> <td>enumeration</td> <td>3</td> </tr> </tbody> </table>	Kind	Value	pattern	[1-9]	enumeration	1	enumeration	2	enumeration	3
Kind	Value										
pattern	[1-9]										
enumeration	1										
enumeration	2										
enumeration	3										

simpleType [Mesi_Type](#)

namespace	urn:www.agenziaentrate.gov.it:specificheTecniche:sco:730														
type	restriction of DatoNP_Type														
facets	<table border="1"> <thead> <tr> <th>Kind</th> <th>Value</th> </tr> </thead> <tbody> <tr> <td>pattern</td> <td>[1-9]{1}[0-9]*</td> </tr> <tr> <td>enumeration</td> <td>1</td> </tr> <tr> <td>enumeration</td> <td>2</td> </tr> <tr> <td>enumeration</td> <td>3</td> </tr> <tr> <td>enumeration</td> <td>4</td> </tr> <tr> <td>enumeration</td> <td>5</td> </tr> </tbody> </table>	Kind	Value	pattern	[1-9]{1}[0-9]*	enumeration	1	enumeration	2	enumeration	3	enumeration	4	enumeration	5
Kind	Value														
pattern	[1-9]{1}[0-9]*														
enumeration	1														
enumeration	2														
enumeration	3														
enumeration	4														
enumeration	5														

	enumeration	6
	enumeration	7
	enumeration	8
	enumeration	9
	enumeration	10
	enumeration	11
	enumeration	12

simpleType **Numero_Rata_Risparmio_Energetico_Type**

namespace	urn:www.agenziaentrate.gov.it:specificheTecniche:sco:730	
type	restriction of DatoNP_Type	
facets	Kind	Value
	pattern	[1-9]{1}[0-9]*
	enumeration	1
	enumeration	2
	enumeration	3
	enumeration	4
	enumeration	5
	enumeration	6
	enumeration	9

simpleType **Periodo_Spese_Ristrutturazione_Type**

namespace	urn:www.agenziaentrate.gov.it:specificheTecniche:sco:730	
type	restriction of DatoN1_Type	
facets	Kind	Value
	pattern	[1-9]
	enumeration	2
	enumeration	3
	enumeration	4

simpleType **Rate10_Type**

namespace	urn:www.agenziaentrate.gov.it:specificheTecniche:sco:730	
type	restriction of DatoNP_Type	
facets	Kind	Value
	pattern	[1-9]{1}[0-9]*
	enumeration	1
	enumeration	2
	enumeration	3
	enumeration	4
	enumeration	5
	enumeration	6
	enumeration	7
	enumeration	8
	enumeration	9
	enumeration	10

simpleType **Rate_Risparmio_Energetico_Type**

namespace	urn:www.agenziaentrate.gov.it:specificheTecniche:sco:730	
type	restriction of DatoNP_Type	
facets	Kind	Value
	pattern	[1-9]{1}[0-9]*
	enumeration	4

	enumeration	7
	enumeration	8

simpleType Terreni_Urbano_Type

namespace	urn:www.agenziaentrate.gov.it:specificheTecniche:sco:730	
type	restriction of DatoAN_Type	
facets	Kind	Value
	pattern	[(0-9A-Z-] \"){1}([0-9A-Z&] ' \\-\\. , /° \\ \\(\\) À È É ì ò Ù Û " \\ \\ \\ +)*
	enumeration	T
	enumeration	U

simpleType Tipo_Inquilino_Type

namespace	urn:www.agenziaentrate.gov.it:specificheTecniche:sco:730	
type	restriction of DatoNP_Type	
facets	Kind	Value
	pattern	[1-9]{1}[0-9]*
	enumeration	1
	enumeration	2
	enumeration	3
	enumeration	4

simpleType Tipo_Intervento_Type

namespace	urn:www.agenziaentrate.gov.it:specificheTecniche:sco:730	
type	restriction of DatoN1_Type	
facets	Kind	Value
	pattern	[1-9]
	enumeration	1
	enumeration	2
	enumeration	3
	enumeration	4
	enumeration	5
	enumeration	6
	enumeration	7

simpleType Tipo_Reddito_Da1a12_Type

namespace	urn:www.agenziaentrate.gov.it:specificheTecniche:sco:730	
type	restriction of DatoNP_Type	
facets	Kind	Value
	pattern	[1-9]{1}[0-9]*
	enumeration	1
	enumeration	2
	enumeration	3
	enumeration	4
	enumeration	5
	enumeration	6
	enumeration	7
	enumeration	8
	enumeration	9
	enumeration	10
	enumeration	11
	enumeration	12

simpleType Tipo_Redito_Da1a3_Type

namespace	urn:www.agenziaentrate.gov.it:specificheTecniche:sco:730										
type	restriction of DatoN1_Type										
facets	<table><thead><tr><th>Kind</th><th>Value</th></tr></thead><tbody><tr><td>pattern</td><td>[1-9]</td></tr><tr><td>enumeration</td><td>1</td></tr><tr><td>enumeration</td><td>2</td></tr><tr><td>enumeration</td><td>3</td></tr></tbody></table>	Kind	Value	pattern	[1-9]	enumeration	1	enumeration	2	enumeration	3
Kind	Value										
pattern	[1-9]										
enumeration	1										
enumeration	2										
enumeration	3										

simpleType Tipo_Redito_Da1a4_Type

namespace	urn:www.agenziaentrate.gov.it:specificheTecniche:sco:730												
type	restriction of DatoN1_Type												
facets	<table><thead><tr><th>Kind</th><th>Value</th></tr></thead><tbody><tr><td>pattern</td><td>[1-9]</td></tr><tr><td>enumeration</td><td>1</td></tr><tr><td>enumeration</td><td>2</td></tr><tr><td>enumeration</td><td>3</td></tr><tr><td>enumeration</td><td>4</td></tr></tbody></table>	Kind	Value	pattern	[1-9]	enumeration	1	enumeration	2	enumeration	3	enumeration	4
Kind	Value												
pattern	[1-9]												
enumeration	1												
enumeration	2												
enumeration	3												
enumeration	4												

simpleType Tipo_Redito_Da1a8_Type

namespace	urn:www.agenziaentrate.gov.it:specificheTecniche:sco:730																				
type	restriction of DatoNP_Type																				
facets	<table><thead><tr><th>Kind</th><th>Value</th></tr></thead><tbody><tr><td>pattern</td><td>[1-9]{1}[0-9]*</td></tr><tr><td>enumeration</td><td>1</td></tr><tr><td>enumeration</td><td>2</td></tr><tr><td>enumeration</td><td>3</td></tr><tr><td>enumeration</td><td>4</td></tr><tr><td>enumeration</td><td>5</td></tr><tr><td>enumeration</td><td>6</td></tr><tr><td>enumeration</td><td>7</td></tr><tr><td>enumeration</td><td>8</td></tr></tbody></table>	Kind	Value	pattern	[1-9]{1}[0-9]*	enumeration	1	enumeration	2	enumeration	3	enumeration	4	enumeration	5	enumeration	6	enumeration	7	enumeration	8
Kind	Value																				
pattern	[1-9]{1}[0-9]*																				
enumeration	1																				
enumeration	2																				
enumeration	3																				
enumeration	4																				
enumeration	5																				
enumeration	6																				
enumeration	7																				
enumeration	8																				

simpleType Tipo_Redito_Da1a9_Type

namespace	urn:www.agenziaentrate.gov.it:specificheTecniche:sco:730																						
type	restriction of DatoNP_Type																						
facets	<table><thead><tr><th>Kind</th><th>Value</th></tr></thead><tbody><tr><td>pattern</td><td>[1-9]{1}[0-9]*</td></tr><tr><td>enumeration</td><td>1</td></tr><tr><td>enumeration</td><td>2</td></tr><tr><td>enumeration</td><td>3</td></tr><tr><td>enumeration</td><td>4</td></tr><tr><td>enumeration</td><td>5</td></tr><tr><td>enumeration</td><td>6</td></tr><tr><td>enumeration</td><td>7</td></tr><tr><td>enumeration</td><td>8</td></tr><tr><td>enumeration</td><td>9</td></tr></tbody></table>	Kind	Value	pattern	[1-9]{1}[0-9]*	enumeration	1	enumeration	2	enumeration	3	enumeration	4	enumeration	5	enumeration	6	enumeration	7	enumeration	8	enumeration	9
Kind	Value																						
pattern	[1-9]{1}[0-9]*																						
enumeration	1																						
enumeration	2																						
enumeration	3																						
enumeration	4																						
enumeration	5																						
enumeration	6																						
enumeration	7																						
enumeration	8																						
enumeration	9																						

simpleType **Tipologia_Soggetto_Ass_Fisc_Type**

namespace	urn:www.agenziaentrate.gov.it:specificheTecniche:sco:730														
type	restriction of DatoN1_Type														
facets	<table border="1"> <thead> <tr> <th>Kind</th> <th>Value</th> </tr> </thead> <tbody> <tr> <td>pattern</td> <td>[1-9]</td> </tr> <tr> <td>enumeration</td> <td>1</td> </tr> <tr> <td>enumeration</td> <td>2</td> </tr> <tr> <td>enumeration</td> <td>3</td> </tr> <tr> <td>enumeration</td> <td>4</td> </tr> <tr> <td>enumeration</td> <td>5</td> </tr> </tbody> </table>	Kind	Value	pattern	[1-9]	enumeration	1	enumeration	2	enumeration	3	enumeration	4	enumeration	5
Kind	Value														
pattern	[1-9]														
enumeration	1														
enumeration	2														
enumeration	3														
enumeration	4														
enumeration	5														

simpleType **Titolo_Terreno_Type**

namespace	urn:www.agenziaentrate.gov.it:specificheTecniche:sco:730																				
type	restriction of DatoNP_Type																				
facets	<table border="1"> <thead> <tr> <th>Kind</th> <th>Value</th> </tr> </thead> <tbody> <tr> <td>pattern</td> <td>[1-9]{1}[0-9]*</td> </tr> <tr> <td>enumeration</td> <td>1</td> </tr> <tr> <td>enumeration</td> <td>2</td> </tr> <tr> <td>enumeration</td> <td>3</td> </tr> <tr> <td>enumeration</td> <td>4</td> </tr> <tr> <td>enumeration</td> <td>5</td> </tr> <tr> <td>enumeration</td> <td>6</td> </tr> <tr> <td>enumeration</td> <td>7</td> </tr> <tr> <td>enumeration</td> <td>10</td> </tr> </tbody> </table>	Kind	Value	pattern	[1-9]{1}[0-9]*	enumeration	1	enumeration	2	enumeration	3	enumeration	4	enumeration	5	enumeration	6	enumeration	7	enumeration	10
Kind	Value																				
pattern	[1-9]{1}[0-9]*																				
enumeration	1																				
enumeration	2																				
enumeration	3																				
enumeration	4																				
enumeration	5																				
enumeration	6																				
enumeration	7																				
enumeration	10																				

simpleType **Utilizzo_Fabbricato_Type**

namespace	urn:www.agenziaentrate.gov.it:specificheTecniche:sco:730																																
type	restriction of DatoNP_Type																																
facets	<table border="1"> <thead> <tr> <th>Kind</th> <th>Value</th> </tr> </thead> <tbody> <tr> <td>pattern</td> <td>[1-9]{1}[0-9]*</td> </tr> <tr> <td>enumeration</td> <td>1</td> </tr> <tr> <td>enumeration</td> <td>2</td> </tr> <tr> <td>enumeration</td> <td>3</td> </tr> <tr> <td>enumeration</td> <td>4</td> </tr> <tr> <td>enumeration</td> <td>5</td> </tr> <tr> <td>enumeration</td> <td>8</td> </tr> <tr> <td>enumeration</td> <td>9</td> </tr> <tr> <td>enumeration</td> <td>10</td> </tr> <tr> <td>enumeration</td> <td>11</td> </tr> <tr> <td>enumeration</td> <td>12</td> </tr> <tr> <td>enumeration</td> <td>14</td> </tr> <tr> <td>enumeration</td> <td>15</td> </tr> <tr> <td>enumeration</td> <td>16</td> </tr> <tr> <td>enumeration</td> <td>17</td> </tr> </tbody> </table>	Kind	Value	pattern	[1-9]{1}[0-9]*	enumeration	1	enumeration	2	enumeration	3	enumeration	4	enumeration	5	enumeration	8	enumeration	9	enumeration	10	enumeration	11	enumeration	12	enumeration	14	enumeration	15	enumeration	16	enumeration	17
Kind	Value																																
pattern	[1-9]{1}[0-9]*																																
enumeration	1																																
enumeration	2																																
enumeration	3																																
enumeration	4																																
enumeration	5																																
enumeration	8																																
enumeration	9																																
enumeration	10																																
enumeration	11																																
enumeration	12																																
enumeration	14																																
enumeration	15																																
enumeration	16																																
enumeration	17																																

complexType **Dati_Anagrafici_Type**

diagram	
namespace	urn:www.agenziaentrate.gov.it:specificheTecniche:sco:common
children	Cognome Nome Sesso DataNascita ComuneNascita ProvinciaNascita

element **Dati_Anagrafici_Type/Cognome**

diagram					
namespace	urn:www.agenziaentrate.gov.it:specificheTecniche:sco:common				
type	DatoAN_Type				
facets	<table border="0"> <tr> <td>Kind</td> <td>Value</td> </tr> <tr> <td>pattern</td> <td>(([0-9A-Z-] &quot;){1}([0-9A-Z&amp;] ' \"- \\. / ° \\^\\(\\ \\)\\ À É Ê Ì Ò Ù Ü &quot; \\ \\ \\ +)*</td> </tr> </table>	Kind	Value	pattern	(([0-9A-Z-] "){1}([0-9A-Z&] ' \"- \\. / ° \\^\\(\\ \\)\\ À É Ê Ì Ò Ù Ü " \\ \\ \\ +)*
Kind	Value				
pattern	(([0-9A-Z-] "){1}([0-9A-Z&] ' \"- \\. / ° \\^\\(\\ \\)\\ À É Ê Ì Ò Ù Ü " \\ \\ \\ +)*				

element **Dati_Anagrafici_Type/Nome**

diagram					
namespace	urn:www.agenziaentrate.gov.it:specificheTecniche:sco:common				
type	DatoAN_Type				
facets	<table border="0"> <tr> <td>Kind</td> <td>Value</td> </tr> <tr> <td>pattern</td> <td>(([0-9A-Z-] &quot;){1}([0-9A-Z&amp;] ' \"- \\. / ° \\^\\(\\ \\)\\ À É Ê Ì Ò Ù Ü &quot; \\ \\ \\ +)*</td> </tr> </table>	Kind	Value	pattern	(([0-9A-Z-] "){1}([0-9A-Z&] ' \"- \\. / ° \\^\\(\\ \\)\\ À É Ê Ì Ò Ù Ü " \\ \\ \\ +)*
Kind	Value				
pattern	(([0-9A-Z-] "){1}([0-9A-Z&] ' \"- \\. / ° \\^\\(\\ \\)\\ À É Ê Ì Ò Ù Ü " \\ \\ \\ +)*				

element **Dati_Anagrafici_Type/Sesso**

diagram									
namespace	urn:www.agenziaentrate.gov.it:specificheTecniche:sco:common								
type	Sesso_Type								
facets	<table border="0"> <tr> <td>Kind</td> <td>Value</td> </tr> <tr> <td>pattern</td> <td>(([0-9A-Z-] &quot;){1}([0-9A-Z&amp;] ' \"- \\. / ° \\^\\(\\ \\)\\ À É Ê Ì Ò Ù Ü &quot; \\ \\ \\ +)*</td> </tr> <tr> <td>enumeration</td> <td>M</td> </tr> <tr> <td>enumeration</td> <td>F</td> </tr> </table>	Kind	Value	pattern	(([0-9A-Z-] "){1}([0-9A-Z&] ' \"- \\. / ° \\^\\(\\ \\)\\ À É Ê Ì Ò Ù Ü " \\ \\ \\ +)*	enumeration	M	enumeration	F
Kind	Value								
pattern	(([0-9A-Z-] "){1}([0-9A-Z&] ' \"- \\. / ° \\^\\(\\ \\)\\ À É Ê Ì Ò Ù Ü " \\ \\ \\ +)*								
enumeration	M								
enumeration	F								

element **Dati_Anagrafici_Type/DataNascita**

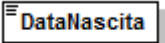
diagram					
namespace	urn:www.agenziaentrate.gov.it:specificheTecniche:sco:common				
type	DatoDT_Type				
facets	<table border="0"> <tr> <td>Kind</td> <td>Value</td> </tr> <tr> <td>pattern</td> <td>((([0-9]{12}[0-9]{3}[01])([0-9]{10} 12)\d{4}))((([0-9]{12}[0-9]{30})([0-9]{11})\d{4}))((([0-9]{1}[0-9]{2}[0-8])(02)\d{4}))((29)(02)([0-9]{2}[048]00))((29)(02)([1-9]{2}[26]00))((29)(02)([0-9]{0}[48]))((29)(02)([0-9]{0-9}[2468][048]))((29)(02)([0-9]{0-9}[13579][26]))</td> </tr> </table>	Kind	Value	pattern	((([0-9]{12}[0-9]{3}[01])([0-9]{10} 12)\d{4}))((([0-9]{12}[0-9]{30})([0-9]{11})\d{4}))((([0-9]{1}[0-9]{2}[0-8])(02)\d{4}))((29)(02)([0-9]{2}[048]00))((29)(02)([1-9]{2}[26]00))((29)(02)([0-9]{0}[48]))((29)(02)([0-9]{0-9}[2468][048]))((29)(02)([0-9]{0-9}[13579][26]))
Kind	Value				
pattern	((([0-9]{12}[0-9]{3}[01])([0-9]{10} 12)\d{4}))((([0-9]{12}[0-9]{30})([0-9]{11})\d{4}))((([0-9]{1}[0-9]{2}[0-8])(02)\d{4}))((29)(02)([0-9]{2}[048]00))((29)(02)([1-9]{2}[26]00))((29)(02)([0-9]{0}[48]))((29)(02)([0-9]{0-9}[2468][048]))((29)(02)([0-9]{0-9}[13579][26]))				

element **Dati_Anagrafici_Type/ComuneNascita**

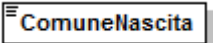
diagram					
namespace	urn:www.agenziaentrate.gov.it:specificheTecniche:sco:common				
type	DatoAN_Type				
facets	<table border="0"> <tr> <td>Kind</td> <td>Value</td> </tr> <tr> <td>pattern</td> <td>([0-9A-Z\-\-]&quot;){1}([0-9A-Z&amp;:] ' ~ \- . \./ ° ' ^\(\)\ À É È Ì Ò Ù Û Ü&quot; \\ / +)*</td> </tr> </table>	Kind	Value	pattern	([0-9A-Z\-\-]"){1}([0-9A-Z&:] ' ~ \- . \./ ° ' ^\(\)\ À É È Ì Ò Ù Û Ü" \\ / +)*
Kind	Value				
pattern	([0-9A-Z\-\-]"){1}([0-9A-Z&:] ' ~ \- . \./ ° ' ^\(\)\ À É È Ì Ò Ù Û Ü" \\ / +)*				

element **Dati_Anagrafici_Type/ProvinciaNascita**

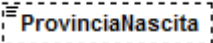
diagram	
namespace	urn:www.agenziaentrate.gov.it:specificheTecniche:sco:common
type	PN_Type

complexType **Dati_Sottoscrittore_Type**

diagram	
namespace	urn:www.agenziaentrate.gov.it:specificheTecniche:sco:common
children	CodiceFiscale CodiceCarica CodiceFiscaleSocieta DatiAnagrafici ResidenzaEstera Telefono DataCarica InizioProcedura ProceduraNonTerminata FineProcedura

element **Dati_Sottoscrittore_Type/CodiceFiscale**

diagram					
namespace	urn:www.agenziaentrate.gov.it:specificheTecniche:sco:common				
type	DatoCF_Type				
facets	<table border="1"> <thead> <tr> <th>Kind</th> <th>Value</th> </tr> </thead> <tbody> <tr> <td>pattern</td> <td>[0-9]{11}[A-Z]{6}[0-9LMNPQRSTUUV]{2}[A-Z]{1}[0-9LMNPQRSTUUV]{2}[A-Z]{1}[0-9LMNPQRSTUUV]{3}[A-Z]{1}</td> </tr> </tbody> </table>	Kind	Value	pattern	[0-9]{11}[A-Z]{6}[0-9LMNPQRSTUUV]{2}[A-Z]{1}[0-9LMNPQRSTUUV]{2}[A-Z]{1}[0-9LMNPQRSTUUV]{3}[A-Z]{1}
Kind	Value				
pattern	[0-9]{11}[A-Z]{6}[0-9LMNPQRSTUUV]{2}[A-Z]{1}[0-9LMNPQRSTUUV]{2}[A-Z]{1}[0-9LMNPQRSTUUV]{3}[A-Z]{1}				

element **Dati_Sottoscrittore_Type/CodiceCarica**

diagram																			
namespace	urn:www.agenziaentrate.gov.it:specificheTecniche:sco:common																		
type	Codice_Carica_Type																		
facets	<table border="1"> <thead> <tr> <th>Kind</th> <th>Value</th> </tr> </thead> <tbody> <tr> <td>pattern</td> <td>[1-9]{1}[0-9]*</td> </tr> <tr> <td>enumeration</td> <td>1</td> </tr> <tr> <td>enumeration</td> <td>2</td> </tr> <tr> <td>enumeration</td> <td>3</td> </tr> <tr> <td>enumeration</td> <td>4</td> </tr> <tr> <td>enumeration</td> <td>5</td> </tr> <tr> <td>enumeration</td> <td>6</td> </tr> <tr> <td>enumeration</td> <td>7</td> </tr> </tbody> </table>	Kind	Value	pattern	[1-9]{1}[0-9]*	enumeration	1	enumeration	2	enumeration	3	enumeration	4	enumeration	5	enumeration	6	enumeration	7
Kind	Value																		
pattern	[1-9]{1}[0-9]*																		
enumeration	1																		
enumeration	2																		
enumeration	3																		
enumeration	4																		
enumeration	5																		
enumeration	6																		
enumeration	7																		

	enumeration	8
	enumeration	9
	enumeration	10
	enumeration	11
	enumeration	12
	enumeration	13
	enumeration	14
	enumeration	15

element **Dati_Sottoscrittore_Type/CodiceFiscaleSocieta**

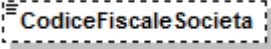
diagram					
namespace	urn:www.agenziaentrate.gov.it:specificheTecniche:sco:common				
type	DatoCN_Type				
facets	<table border="1"> <tr> <th>Kind</th> <th>Value</th> </tr> <tr> <td>pattern</td> <td>[0-9]{11}</td> </tr> </table>	Kind	Value	pattern	[0-9]{11}
Kind	Value				
pattern	[0-9]{11}				

element **Dati_Sottoscrittore_Type/DatiAnagrafici**

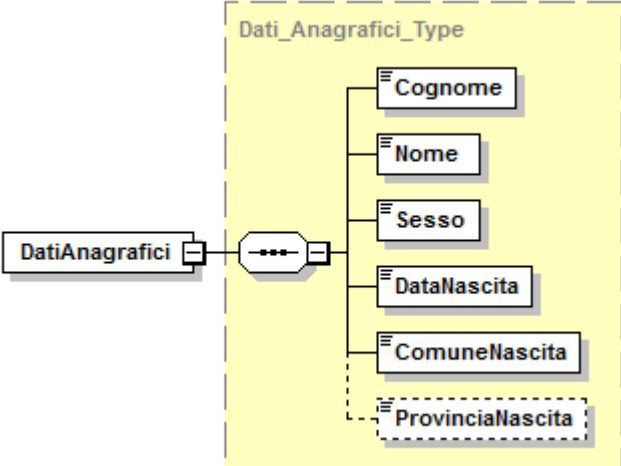
diagram	
namespace	urn:www.agenziaentrate.gov.it:specificheTecniche:sco:common
type	Dati_Anagrafici_Type
children	Cognome Nome Sesso DataNascita ComuneNascita ProvinciaNascita

element **Dati_Sottoscrittore_Type/ResidenzaEstera**

diagram	
namespace	urn:www.agenziaentrate.gov.it:specificheTecniche:sco:common
type	Residenza_Estera_Type
children	CodiceStatoEstero StatoFederato LocalitaEstero IndirizzoEstero

element **Dati_Sottoscrittore_Type/Telefono**

diagram					
namespace	urn:www.agenziaentrate.gov.it:specificheTecniche:sco:common				
type	DatoTL_Type				
facets	<table border="1"> <thead> <tr> <th>Kind</th> <th>Value</th> </tr> </thead> <tbody> <tr> <td>pattern</td> <td>[0-9]*</td> </tr> </tbody> </table>	Kind	Value	pattern	[0-9]*
Kind	Value				
pattern	[0-9]*				

element **Dati_Sottoscrittore_Type/DataCarica**

diagram					
namespace	urn:www.agenziaentrate.gov.it:specificheTecniche:sco:common				
type	DatoDT_Type				
facets	<table border="1"> <thead> <tr> <th>Kind</th> <th>Value</th> </tr> </thead> <tbody> <tr> <td>pattern</td> <td>((([0-9]{1,2}[0-9]{3,4}) (0[13578]{10,12}\d{4})) ((([0-9]{1,2}[0-9]{3,4}) (0[13578]{10,12}\d{4})) ((([0-9]{1,2}[0-9]{3,4}) (0[13578]{10,12}\d{4})) ((29)(02)([02468]{048}00)) ((29)(02)([13579]{26}00)) ((29)(02)([0-9]{0-9}[0148])) ((29)(02)([0-9]{0-9}[2468][048])) ((29)(02)([0-9]{0-9}[13579][26])))))</td> </tr> </tbody> </table>	Kind	Value	pattern	((([0-9]{1,2}[0-9]{3,4}) (0[13578]{10,12}\d{4})) ((([0-9]{1,2}[0-9]{3,4}) (0[13578]{10,12}\d{4})) ((([0-9]{1,2}[0-9]{3,4}) (0[13578]{10,12}\d{4})) ((29)(02)([02468]{048}00)) ((29)(02)([13579]{26}00)) ((29)(02)([0-9]{0-9}[0148])) ((29)(02)([0-9]{0-9}[2468][048])) ((29)(02)([0-9]{0-9}[13579][26])))))
Kind	Value				
pattern	((([0-9]{1,2}[0-9]{3,4}) (0[13578]{10,12}\d{4})) ((([0-9]{1,2}[0-9]{3,4}) (0[13578]{10,12}\d{4})) ((([0-9]{1,2}[0-9]{3,4}) (0[13578]{10,12}\d{4})) ((29)(02)([02468]{048}00)) ((29)(02)([13579]{26}00)) ((29)(02)([0-9]{0-9}[0148])) ((29)(02)([0-9]{0-9}[2468][048])) ((29)(02)([0-9]{0-9}[13579][26])))))				

element **Dati_Sottoscrittore_Type/InizioProcedura**

diagram					
namespace	urn:www.agenziaentrate.gov.it:specificheTecniche:sco:common				
type	DatoDT_Type				
facets	<table border="1"> <thead> <tr> <th>Kind</th> <th>Value</th> </tr> </thead> <tbody> <tr> <td>pattern</td> <td>((([0-9]{1,2}[0-9]{3,4}) (0[13578]{10,12}\d{4})) ((([0-9]{1,2}[0-9]{3,4}) (0[13578]{10,12}\d{4})) ((([0-9]{1,2}[0-9]{3,4}) (0[13578]{10,12}\d{4})) ((29)(02)([02468]{048}00)) ((29)(02)([13579]{26}00)) ((29)(02)([0-9]{0-9}[0148])) ((29)(02)([0-9]{0-9}[2468][048])) ((29)(02)([0-9]{0-9}[13579][26])))))</td> </tr> </tbody> </table>	Kind	Value	pattern	((([0-9]{1,2}[0-9]{3,4}) (0[13578]{10,12}\d{4})) ((([0-9]{1,2}[0-9]{3,4}) (0[13578]{10,12}\d{4})) ((([0-9]{1,2}[0-9]{3,4}) (0[13578]{10,12}\d{4})) ((29)(02)([02468]{048}00)) ((29)(02)([13579]{26}00)) ((29)(02)([0-9]{0-9}[0148])) ((29)(02)([0-9]{0-9}[2468][048])) ((29)(02)([0-9]{0-9}[13579][26])))))
Kind	Value				
pattern	((([0-9]{1,2}[0-9]{3,4}) (0[13578]{10,12}\d{4})) ((([0-9]{1,2}[0-9]{3,4}) (0[13578]{10,12}\d{4})) ((([0-9]{1,2}[0-9]{3,4}) (0[13578]{10,12}\d{4})) ((29)(02)([02468]{048}00)) ((29)(02)([13579]{26}00)) ((29)(02)([0-9]{0-9}[0148])) ((29)(02)([0-9]{0-9}[2468][048])) ((29)(02)([0-9]{0-9}[13579][26])))))				

element **Dati_Sottoscrittore_Type/ProceduraNonTerminata**

diagram	
namespace	urn:www.agenziaentrate.gov.it:specificheTecniche:sco:common
type	DatoCB_Type
facets	Kind Value pattern [01]

element **Dati_Sottoscrittore_Type/FineProcedura**

diagram	
namespace	urn:www.agenziaentrate.gov.it:specificheTecniche:sco:common
type	DatoDT_Type
facets	Kind Value pattern (((([0-9][12][0-9][301])(0[13578]1012)\d{4})))(((0[1-9][12][0-9][30](0[469]11)\d{4})))(((0[1-9]1[0-9]2[0-8])(02)\d{4})))(((29)(02)([02468][048]00)))(((29)(02)([13579][26]00)))(((29)(02)([0-9][0-9][0][48])))(((29)(02)([0-9][0-9][2468][048])))(((29)(02)([0-9][0-9][13579][26])))

complexType **Domicilio_EE_Type**

diagram	
namespace	urn:www.agenziaentrate.gov.it:specificheTecniche:sco:common
children	Comune Provincia CodiceComune Indirizzo Cap DataVariazione

element **Domicilio_EE_Type/Comune**

diagram	
namespace	urn:www.agenziaentrate.gov.it:specificheTecniche:sco:common
type	DatoAN_Type
facets	Kind Value pattern (([0-9A-Z-] \"){1}([0-9A-Z&:] \- \., / \^\(\ \)\ À È É Ì Ò Ù Û " \ \\ / +)*

element Domicilio_EE_Type/Provincia

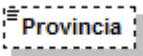
diagram	
namespace	urn:www.agenziaentrate.gov.it:specificheTecniche:sco:common
type	PE_Type

element Domicilio_EE_Type/CodiceComune

diagram					
namespace	urn:www.agenziaentrate.gov.it:specificheTecniche:sco:common				
type	DatoAN_Type				
facets	<table border="0"> <tr> <td>Kind</td> <td>Value</td> </tr> <tr> <td>pattern</td> <td>(([0-9A-Z\-\]&quot;){1}([0-9A-Z&amp;#39;] " \- \., / "^\(\ \) À É È Ì Ò Ù Û &quot; \ \\ +)*</td> </tr> </table>	Kind	Value	pattern	(([0-9A-Z\-\]"){1}([0-9A-Z&#39;] " \- \., / "^\(\ \) À É È Ì Ò Ù Û " \ \\ +)*
Kind	Value				
pattern	(([0-9A-Z\-\]"){1}([0-9A-Z&#39;] " \- \., / "^\(\ \) À É È Ì Ò Ù Û " \ \\ +)*				

element Domicilio_EE_Type/Indirizzo

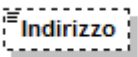
diagram					
namespace	urn:www.agenziaentrate.gov.it:specificheTecniche:sco:common				
type	DatoAN_Type				
facets	<table border="0"> <tr> <td>Kind</td> <td>Value</td> </tr> <tr> <td>pattern</td> <td>(([0-9A-Z\-\]&quot;){1}([0-9A-Z&amp;#39;] " \- \., / "^\(\ \) À É È Ì Ò Ù Û &quot; \ \\ +)*</td> </tr> </table>	Kind	Value	pattern	(([0-9A-Z\-\]"){1}([0-9A-Z&#39;] " \- \., / "^\(\ \) À É È Ì Ò Ù Û " \ \\ +)*
Kind	Value				
pattern	(([0-9A-Z\-\]"){1}([0-9A-Z&#39;] " \- \., / "^\(\ \) À É È Ì Ò Ù Û " \ \\ +)*				

element Domicilio_EE_Type/Cap

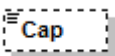
diagram					
namespace	urn:www.agenziaentrate.gov.it:specificheTecniche:sco:common				
type	DatoCP_Type				
facets	<table border="0"> <tr> <td>Kind</td> <td>Value</td> </tr> <tr> <td>pattern</td> <td>[0-9]{5}</td> </tr> </table>	Kind	Value	pattern	[0-9]{5}
Kind	Value				
pattern	[0-9]{5}				

element Domicilio_EE_Type/DataVariazione

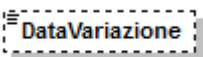
diagram					
namespace	urn:www.agenziaentrate.gov.it:specificheTecniche:sco:common				
type	DatoD6_Type				
facets	<table border="0"> <tr> <td>Kind</td> <td>Value</td> </tr> <tr> <td>pattern</td> <td>(([0-9])([10-2]))((19 20)[0-9][0-9])</td> </tr> </table>	Kind	Value	pattern	(([0-9])([10-2]))((19 20)[0-9][0-9])
Kind	Value				
pattern	(([0-9])([10-2]))((19 20)[0-9][0-9])				

complexType **Domicilio_Fiscale_Type**

diagram	
namespace	urn:www.agenziaentrate.gov.it:specificheTecniche:sco:common
type	extension of Domicilio_Ita_Type
children	Comune Provincia CodiceComune Indirizzo Cap DataVariazione

element **Domicilio_Fiscale_Type/DataVariazione**

diagram					
namespace	urn:www.agenziaentrate.gov.it:specificheTecniche:sco:common				
type	DatoD6_Type				
facets	<table border="1"> <thead> <tr> <th>Kind</th> <th>Value</th> </tr> </thead> <tbody> <tr> <td>pattern</td> <td>((0[0-9]) (1[0-2]))((19 20)[0-9][0-9])</td> </tr> </tbody> </table>	Kind	Value	pattern	((0[0-9]) (1[0-2]))((19 20)[0-9][0-9])
Kind	Value				
pattern	((0[0-9]) (1[0-2]))((19 20)[0-9][0-9])				

complexType **Domicilio_Ita_Type**

diagram	
namespace	urn:www.agenziaentrate.gov.it:specificheTecniche:sco:common
children	Comune Provincia CodiceComune Indirizzo Cap

element Domicilio_Ita_Type/Comune

diagram	
namespace	urn:www.agenziaentrate.gov.it:specificheTecniche:sco:common
type	DatoAN_Type
facets	Kind Value pattern ([0-9A-Z\-\-]"){1}([0-9A-Z&:] \- \., / ^ \^\(\ \) À È É Ì Ò Ù Û " \ \ /+)*

element Domicilio_Ita_Type/Provincia

diagram	
namespace	urn:www.agenziaentrate.gov.it:specificheTecniche:sco:common
type	PR_Type

element Domicilio_Ita_Type/CodiceComune

diagram	
namespace	urn:www.agenziaentrate.gov.it:specificheTecniche:sco:common
type	DatoAN_Type
facets	Kind Value pattern ([0-9A-Z\-\-]"){1}([0-9A-Z&:] \- \., / ^ \^\(\ \) À È É Ì Ò Ù Û " \ \ /+)*

element Domicilio_Ita_Type/Indirizzo

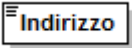
diagram	
namespace	urn:www.agenziaentrate.gov.it:specificheTecniche:sco:common
type	DatoAN_Type
facets	Kind Value pattern ([0-9A-Z\-\-]"){1}([0-9A-Z&:] \- \., / ^ \^\(\ \) À È É Ì Ò Ù Û " \ \ /+)*

element Domicilio_Ita_Type/Cap

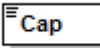
diagram	
namespace	urn:www.agenziaentrate.gov.it:specificheTecniche:sco:common
type	DatoCP_Type
facets	Kind Value pattern [0-9]{5}

complexType Firma_Revisione_Type

diagram	
namespace	urn:www.agenziaentrate.gov.it:specificheTecniche:sco:common
children	Soggetto CodiceFiscale FirmaDichiarante

element Firma_Revisione_Type/Soggetto

diagram					
namespace	urn:www.agenziaentrate.gov.it:specificheTecniche:sco:common				
type	restriction of DatoNP_Type				
facets	<table border="1"> <tr> <td>Kind</td> <td>Value</td> </tr> <tr> <td>pattern</td> <td>[1-4]</td> </tr> </table>	Kind	Value	pattern	[1-4]
Kind	Value				
pattern	[1-4]				

element Firma_Revisione_Type/CodiceFiscale

diagram					
namespace	urn:www.agenziaentrate.gov.it:specificheTecniche:sco:common				
type	DatoCF_Type				
facets	<table border="1"> <tr> <td>Kind</td> <td>Value</td> </tr> <tr> <td>pattern</td> <td>[0-9]{11}[A-Z]{6}[0-9LMNPQRSTU]{2}[A-Z]{1}[0-9LMNPQRSTU]{2}[A-Z]{1}[0-9LMNPQRSTU]{3}[A-Z]{1}</td> </tr> </table>	Kind	Value	pattern	[0-9]{11}[A-Z]{6}[0-9LMNPQRSTU]{2}[A-Z]{1}[0-9LMNPQRSTU]{2}[A-Z]{1}[0-9LMNPQRSTU]{3}[A-Z]{1}
Kind	Value				
pattern	[0-9]{11}[A-Z]{6}[0-9LMNPQRSTU]{2}[A-Z]{1}[0-9LMNPQRSTU]{2}[A-Z]{1}[0-9LMNPQRSTU]{3}[A-Z]{1}				

element Firma_Revisione_Type/FirmaDichiarante

diagram					
namespace	urn:www.agenziaentrate.gov.it:specificheTecniche:sco:common				
type	DatoCB_Type				
facets	<table border="1"> <tr> <td>Kind</td> <td>Value</td> </tr> <tr> <td>pattern</td> <td>[01]</td> </tr> </table>	Kind	Value	pattern	[01]
Kind	Value				
pattern	[01]				

complexType Firma_Type

diagram	
namespace	urn:www.agenziaentrate.gov.it:specificheTecniche:sco:common

children	Firma CodiceFiscale
----------	---

element Firma_Type/Firma

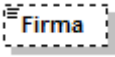
diagram	
namespace	urn:www.agenziaentrate.gov.it:specificheTecniche:sco:common
type	DatoCB_Type
facets	Kind Value pattern [01]

element Firma_Type/CodiceFiscale

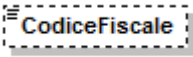
diagram	
namespace	urn:www.agenziaentrate.gov.it:specificheTecniche:sco:common
type	restriction of xs:string
facets	Kind Value pattern (([0-9A-Z-])"){0,1}([0-9A-Z&:] ' - \., s / ^^\(\/\) À È É Ì Ò Ù Ü " \N / +)*

complexType Frontespizio_Type

diagram	
namespace	urn:www.agenziaentrate.gov.it:specificheTecniche:sco:common
children	SoggettoFiscale

element Frontespizio_Type/SoggettoFiscale

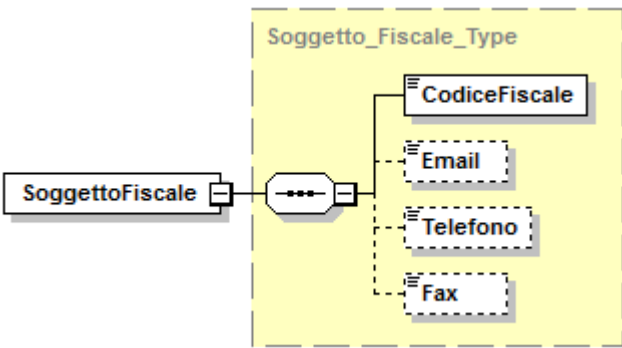
diagram	
namespace	urn:www.agenziaentrate.gov.it:specificheTecniche:sco:common
type	Soggetto_Fiscale_Type
children	CodiceFiscale Email Telefono Fax

complexType Impegno_A_Trasmettere_Type

diagram	
namespace	urn:www.agenziaentrate.gov.it:specificheTecniche:sco:common
children	CFintermediario NumerolscrAlboCAF ImpegnoATrasmettere RicezioneAvvisoTelem DataImpegno FirmaIntermediario

element Impegno_A_Trasmettere_Type/CFintermediario

diagram					
namespace	urn:www.agenziaentrate.gov.it:specificheTecniche:sco:common				
type	DatoCF_Type				
facets	<table border="1"> <thead> <tr> <th>Kind</th> <th>Value</th> </tr> </thead> <tbody> <tr> <td>pattern</td> <td>[0-9]{11}[A-Z]{6}[0-9LMNPQRSTUUV]{2}[A-Z]{1}[0-9LMNPQRSTUUV]{2}[A-Z]{1}[0-9LMNPQRSTUUV]{3}[A-Z]{1}</td> </tr> </tbody> </table>	Kind	Value	pattern	[0-9]{11}[A-Z]{6}[0-9LMNPQRSTUUV]{2}[A-Z]{1}[0-9LMNPQRSTUUV]{2}[A-Z]{1}[0-9LMNPQRSTUUV]{3}[A-Z]{1}
Kind	Value				
pattern	[0-9]{11}[A-Z]{6}[0-9LMNPQRSTUUV]{2}[A-Z]{1}[0-9LMNPQRSTUUV]{2}[A-Z]{1}[0-9LMNPQRSTUUV]{3}[A-Z]{1}				

element Impegno_A_Trasmettere_Type/NumerolscrAlboCAF

diagram					
namespace	urn:www.agenziaentrate.gov.it:specificheTecniche:sco:common				
type	restriction of DatoNU_Type				
facets	<table border="1"> <thead> <tr> <th>Kind</th> <th>Value</th> </tr> </thead> <tbody> <tr> <td>pattern</td> <td>(\[1-9\]\ [1-9]\)[0-9]*</td> </tr> </tbody> </table>	Kind	Value	pattern	(\[1-9\]\ [1-9]\)[0-9]*
Kind	Value				
pattern	(\[1-9\]\ [1-9]\)[0-9]*				

element Impegno_A_Trasmettere_Type/ImpegnoATrasmettere

diagram									
namespace	urn:www.agenziaentrate.gov.it:specificheTecniche:sco:common								
type	restriction of DatoNP_Type								
facets	<table border="1"> <thead> <tr> <th>Kind</th> <th>Value</th> </tr> </thead> <tbody> <tr> <td>pattern</td> <td>1 2</td> </tr> <tr> <td>enumeration</td> <td>1</td> </tr> <tr> <td>enumeration</td> <td>2</td> </tr> </tbody> </table>	Kind	Value	pattern	1 2	enumeration	1	enumeration	2
Kind	Value								
pattern	1 2								
enumeration	1								
enumeration	2								

element **Impegno_A_Trasmettere_Type/RicezioneAvvisoTelem**

diagram	
namespace	urn:www.agenziaentrate.gov.it:specificheTecniche:sco:common
type	DatoCB_Type
facets	Kind Value pattern [01]

element **Impegno_A_Trasmettere_Type/DatalImpegno**

diagram	
namespace	urn:www.agenziaentrate.gov.it:specificheTecniche:sco:common
type	DatoDT_Type
facets	Kind Value pattern (((([0-9][12][0-9][3][01])([0-9][13578][10][12](\d{4})) ([0-9][1-9][12][0-9][30)([0-9][469][11](\d{4})) ([0-9][1-9][1][0-9][2][0-8])(02)(\d{4})) ((29)(02)([0-9][2468][048][00]) ((29)(02)([1-9][26][00]) ((29)(02)([0-9][0-9][0][48]) ((29)(02)([0-9][0-9][2468][048]) ((29)(02)([0-9][0-9][13579][26])))))

element **Impegno_A_Trasmettere_Type/FirmaIntermediario**

diagram	
namespace	urn:www.agenziaentrate.gov.it:specificheTecniche:sco:common
type	DatoCB_Type
facets	Kind Value pattern [01]

complexType **Persone_Fisiche_Type**

diagram	
namespace	urn:www.agenziaentrate.gov.it:specificheTecniche:sco:common
children	DatiAnagrafici ResidenzaAnagrafica

element **Persone_Fisiche_Type/DatiAnagrafici**

diagram	
namespace	urn:www.agenziaentrate.gov.it:specificheTecniche:sco:common
type	Dati_Anagrafici_Type
children	Cognome Nome Sesso DataNascita ComuneNascita ProvinciaNascita

element **Persone_Fisiche_Type/ResidenzaAnagrafica**

diagram	
namespace	urn:www.agenziaentrate.gov.it:specificheTecniche:sco:common
type	Residenza_Anagrafica_Type
children	Comune Provincia CodiceComune Indirizzo Cap DataVariazione

complexType **Residenza_Anagrafica_Type**

diagram	
namespace	urn:www.agenziaentrate.gov.it:specificheTecniche:sco:common
type	extension of Domicilio_Ita_Type
children	Comune Provincia CodiceComune Indirizzo Cap DataVariazione

element **Residenza_Anagrafica_Type/DataVariazione**

diagram					
namespace	urn:www.agenziaentrate.gov.it:specificheTecniche:sco:common				
type	DatoDT_Type				
facets	<table border="1"> <thead> <tr> <th>Kind</th> <th>Value</th> </tr> </thead> <tbody> <tr> <td>pattern</td> <td>((([0-9]{1,2} [0-9]{3} 01))([0-9]{1,2} 10 12)\d{4}) ((([0-9]{1,2} [0-9]{3} 01 30)([0-9]{1,2} 11)\d{4}) ((([0-9]{1,2} [0-9]{3} 01 8) 02)\d{4}) ((29 02)([0-9]{2} 048 00)) ((29 02)([0-9]{2} 26 00)) ((29 02)([0-9]{2} 048)) ((29 02)([0-9]{2} 048)) ((29 02)([0-9]{2} 13579 26))))</td> </tr> </tbody> </table>	Kind	Value	pattern	((([0-9]{1,2} [0-9]{3} 01))([0-9]{1,2} 10 12)\d{4}) ((([0-9]{1,2} [0-9]{3} 01 30)([0-9]{1,2} 11)\d{4}) ((([0-9]{1,2} [0-9]{3} 01 8) 02)\d{4}) ((29 02)([0-9]{2} 048 00)) ((29 02)([0-9]{2} 26 00)) ((29 02)([0-9]{2} 048)) ((29 02)([0-9]{2} 048)) ((29 02)([0-9]{2} 13579 26))))
Kind	Value				
pattern	((([0-9]{1,2} [0-9]{3} 01))([0-9]{1,2} 10 12)\d{4}) ((([0-9]{1,2} [0-9]{3} 01 30)([0-9]{1,2} 11)\d{4}) ((([0-9]{1,2} [0-9]{3} 01 8) 02)\d{4}) ((29 02)([0-9]{2} 048 00)) ((29 02)([0-9]{2} 26 00)) ((29 02)([0-9]{2} 048)) ((29 02)([0-9]{2} 048)) ((29 02)([0-9]{2} 13579 26))))				

complexType **Residenza_Estera_Type**

diagram	
namespace	urn:www.agenziaentrate.gov.it:specificheTecniche:sco:common
children	CodiceStatoEstero StatoFederato LocalitaEstero IndirizzoEstero

element **Residenza_Estera_Type/CodiceStatoEstero**

diagram	
namespace	urn:www.agenziaentrate.gov.it:specificheTecniche:sco:common
type	restriction of DatoAN_Type
facets	Kind Value pattern ([0-9A-Z-]*)"}{1}([0-9A-Z&:] ' - \., / ^ \^\(\ \)\ À É Ê Ì Ò Ù Ü " \ \ /+)*

element **Residenza_Estera_Type/StatoFederato**

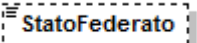
diagram	
namespace	urn:www.agenziaentrate.gov.it:specificheTecniche:sco:common
type	restriction of DatoAN_Type
facets	Kind Value pattern ([0-9A-Z-]*)"}{1}([0-9A-Z&:] ' - \., / ^ \^\(\ \)\ À É Ê Ì Ò Ù Ü " \ \ /+)*

element **Residenza_Estera_Type/LocalitaEstero**

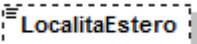
diagram	
namespace	urn:www.agenziaentrate.gov.it:specificheTecniche:sco:common
type	DatoAN_Type
facets	Kind Value pattern ([0-9A-Z-]*)"}{1}([0-9A-Z&:] ' - \., / ^ \^\(\ \)\ À É Ê Ì Ò Ù Ü " \ \ /+)*

element **Residenza_Estera_Type/IndirizzoEstero**

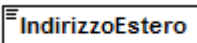
diagram	
namespace	urn:www.agenziaentrate.gov.it:specificheTecniche:sco:common
type	DatoAN_Type
facets	Kind Value pattern ([0-9A-Z-]*)"}{1}([0-9A-Z&:] ' - \., / ^ \^\(\ \)\ À É Ê Ì Ò Ù Ü " \ \ /+)*

element **Soggetti_Diversi_Da_PF_Type/SedeLegale**

diagram	
namespace	urn:www.agenziaentrate.gov.it:specificheTecniche:sco:common
type	Domicilio_EE_Type
children	Comune Provincia CodiceComune Indirizzo Cap DataVariazione

element **Soggetti_Diversi_Da_PF_Type/DomicilioFiscale**

diagram	
namespace	urn:www.agenziaentrate.gov.it:specificheTecniche:sco:common
type	Domicilio_Fiscale_Type
children	Comune Provincia CodiceComune Indirizzo Cap DataVariazione

element **Soggetti_Diversi_Da_PF_Type/DataApprovazioneBilancio**

diagram	
namespace	urn:www.agenziaentrate.gov.it:specificheTecniche:sco:common

	enumeration	2
	enumeration	3
	enumeration	4

element **Soggetti_Diversi_Da_PF_Type/NaturaGiuridica**

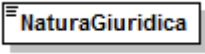
diagram		
namespace	urn:www.agenziaentrate.gov.it:specificheTecniche:sco:common	
type	Natura_Giuridica_Type	
facets	Kind	Value
	pattern	[1-9]{1}[0-9]*
	enumeration	1
	enumeration	2
	enumeration	3
	enumeration	4
	enumeration	5
	enumeration	6
	enumeration	7
	enumeration	8
	enumeration	9
	enumeration	10
	enumeration	11
	enumeration	12
	enumeration	13
	enumeration	14
	enumeration	15
	enumeration	16
	enumeration	17
	enumeration	18
	enumeration	19
	enumeration	20
	enumeration	21
	enumeration	22
	enumeration	23
	enumeration	24
	enumeration	25
	enumeration	26
	enumeration	27
	enumeration	28
	enumeration	29
	enumeration	30
	enumeration	31
	enumeration	32
	enumeration	33
	enumeration	34
	enumeration	35
	enumeration	36
	enumeration	37
	enumeration	38
	enumeration	39
	enumeration	40
	enumeration	41
	enumeration	42
	enumeration	43
	enumeration	44
	enumeration	45
	enumeration	50
	enumeration	51
	enumeration	52
	enumeration	53
	enumeration	54
	enumeration	55

	enumeration	56
	enumeration	57
	enumeration	58
	enumeration	59

element **Soggetti_Diversi_Da_PF_Type/Situazione**

diagram		
namespace	urn:www.agenziaentrate.gov.it:specificheTecniche:sco:common	
type	Situazione Type	
facets	Kind	Value
	pattern	[1-9]{1}[0-9]*
	enumeration	1
	enumeration	2
	enumeration	3
	enumeration	4
	enumeration	5
	enumeration	6
	enumeration	7

complexType **Soggetti_Non_Residenti_Type**

diagram		
namespace	urn:www.agenziaentrate.gov.it:specificheTecniche:sco:common	
children	StatoEsteroResidenza CodiceStatoEstero CodiceIdentificazioneEstero	

element **Soggetti_Non_Residenti_Type/StatoEsteroResidenza**

diagram		
namespace	urn:www.agenziaentrate.gov.it:specificheTecniche:sco:common	
type	DatoAN Type	
facets	Kind	Value
	pattern	([0-9A-Z\-_]"){1}([0-9A-Z&:] ' \- \., / ^ \^\(\ \)\^ È É Ì Ò Ù Û "; \\ / +)*

element **Soggetti_Non_Residenti_Type/CodiceStatoEstero**

diagram		
namespace	urn:www.agenziaentrate.gov.it:specificheTecniche:sco:common	
type	DatoAN Type	

facets	Kind	Value
	pattern	(([0-9A-Z-] \"){1}([0-9A-Z&#39;] '\-\. , / ^\\(\\) À É È Ì Ò Ù Û " \\ \\ +)*

element **Soggetti Non Residenti Type/CodicelIdentificazioneEestero**

diagram	
namespace	urn:www.agenziaentrate.gov.it:specificheTecniche:sco:common
type	DatoAN_Type
facets	Kind Value pattern (([0-9A-Z-] \"){1}([0-9A-Z&#39;] '\-\. , / ^\\(\\) À É È Ì Ò Ù Û " \\ \\ +)*

complexType **Soggetto_Fiscale_Type**

diagram	
namespace	urn:www.agenziaentrate.gov.it:specificheTecniche:sco:common
children	CodiceFiscale Email Telefono Fax

element **Soggetto_Fiscale_Type/CodiceFiscale**

diagram	
namespace	urn:www.agenziaentrate.gov.it:specificheTecniche:sco:common
type	DatoCF_Type
facets	Kind Value pattern [0-9]{11}[A-Z]{6}[0-9LMNPQRSTU]{2}[A-Z]{1}[0-9LMNPQRSTU]{2}[A-Z]{1}[0-9LMNPQRSTU]{3}[A-Z]{1}

element **Soggetto_Fiscale_Type/Email**

diagram	
namespace	urn:www.agenziaentrate.gov.it:specificheTecniche:sco:common
type	DatoEM_Type
facets	Kind Value pattern [a-zA-Z0-9._%'\-'\"?^~=]+@[a-zA-Z0-9.\- \.[a-zA-Z]{2,4}

element **Soggetto_Fiscale_Type/Telefono**

diagram	
namespace	urn:www.agenziaentrate.gov.it:specificheTecniche:sco:common
type	DatoTL_Type
facets	Kind Value pattern [0-9]*

element **Soggetto_Fiscale_Type/Fax**

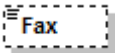
diagram	
namespace	urn:www.agenziaentrate.gov.it:specificheTecniche:sco:common
type	DatoTL_Type
facets	Kind Value pattern [0-9]*

complexType **Tipo_Dichiarazione_Type**

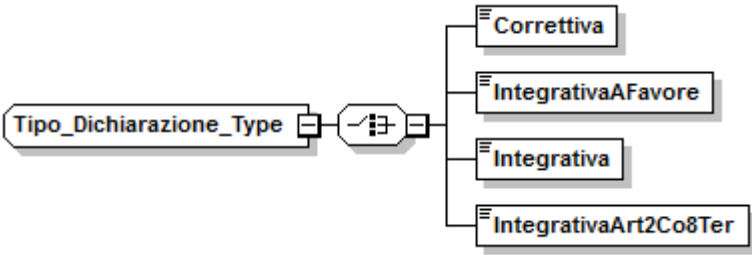
diagram	
namespace	urn:www.agenziaentrate.gov.it:specificheTecniche:sco:common
children	Correttiva IntegrativaAFavore Integrativa IntegrativaArt2Co8Ter

element **Tipo_Dichiarazione_Type/Correttiva**

diagram	
namespace	urn:www.agenziaentrate.gov.it:specificheTecniche:sco:common
type	DatoCB_Type
facets	Kind Value pattern [01]

element **Tipo_Dichiarazione_Type/IntegrativaAFavore**

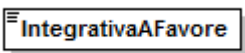
diagram	
namespace	urn:www.agenziaentrate.gov.it:specificheTecniche:sco:common

type	DatoCB_Type
facets	Kind Value pattern [01]

element [Tipo_Dichiarazione_Type/Integrativa](#)

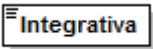
diagram	
namespace	urn:www.agenziaentrate.gov.it:specificheTecniche:sco:common
type	DatoCB_Type
facets	Kind Value pattern [01]

element [Tipo_Dichiarazione_Type/IntegrativaArt2Co8Ter](#)

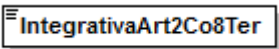
diagram	
namespace	urn:www.agenziaentrate.gov.it:specificheTecniche:sco:common
type	DatoCB_Type
facets	Kind Value pattern [01]

complexType [Visto_Conformita_Type](#)

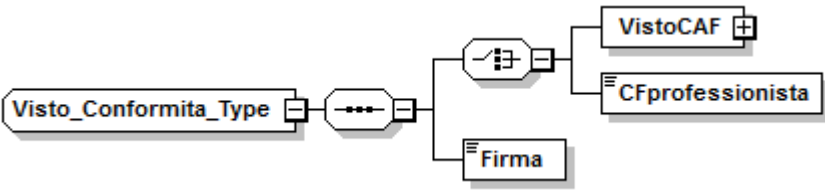
diagram	
namespace	urn:www.agenziaentrate.gov.it:specificheTecniche:sco:common
children	VistoCAF CFprofessionista Firma

element [Visto_Conformita_Type/VistoCAF](#)

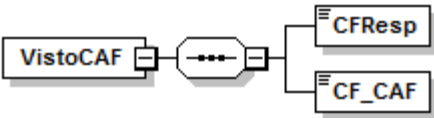
diagram	
namespace	urn:www.agenziaentrate.gov.it:specificheTecniche:sco:common
children	CFResp CF_CAF

element **Visto_Conformita_Type/VistoCAF/CFResp**

diagram					
namespace	urn:www.agenziaentrate.gov.it:specificheTecniche:sco:common				
type	DatoCF_Type				
facets	<table border="1"> <thead> <tr> <th>Kind</th> <th>Value</th> </tr> </thead> <tbody> <tr> <td>pattern</td> <td>[0-9]{11}[A-Z]{6}[0-9LMNPQRSTU]{2}[A-Z]{1}[0-9LMNPQRSTU]{2}[A-Z]{1}[0-9LMNPQRSTU]{3}[A-Z]{1}</td> </tr> </tbody> </table>	Kind	Value	pattern	[0-9]{11}[A-Z]{6}[0-9LMNPQRSTU]{2}[A-Z]{1}[0-9LMNPQRSTU]{2}[A-Z]{1}[0-9LMNPQRSTU]{3}[A-Z]{1}
Kind	Value				
pattern	[0-9]{11}[A-Z]{6}[0-9LMNPQRSTU]{2}[A-Z]{1}[0-9LMNPQRSTU]{2}[A-Z]{1}[0-9LMNPQRSTU]{3}[A-Z]{1}				

element **Visto_Conformita_Type/VistoCAF/CF_CAF**

diagram					
namespace	urn:www.agenziaentrate.gov.it:specificheTecniche:sco:common				
type	DatoCN_Type				
facets	<table border="1"> <thead> <tr> <th>Kind</th> <th>Value</th> </tr> </thead> <tbody> <tr> <td>pattern</td> <td>[0-9]{11}</td> </tr> </tbody> </table>	Kind	Value	pattern	[0-9]{11}
Kind	Value				
pattern	[0-9]{11}				

element **Visto_Conformita_Type/CFprofessionista**

diagram					
namespace	urn:www.agenziaentrate.gov.it:specificheTecniche:sco:common				
type	DatoCF_Type				
facets	<table border="1"> <thead> <tr> <th>Kind</th> <th>Value</th> </tr> </thead> <tbody> <tr> <td>pattern</td> <td>[0-9]{11}[A-Z]{6}[0-9LMNPQRSTU]{2}[A-Z]{1}[0-9LMNPQRSTU]{2}[A-Z]{1}[0-9LMNPQRSTU]{3}[A-Z]{1}</td> </tr> </tbody> </table>	Kind	Value	pattern	[0-9]{11}[A-Z]{6}[0-9LMNPQRSTU]{2}[A-Z]{1}[0-9LMNPQRSTU]{2}[A-Z]{1}[0-9LMNPQRSTU]{3}[A-Z]{1}
Kind	Value				
pattern	[0-9]{11}[A-Z]{6}[0-9LMNPQRSTU]{2}[A-Z]{1}[0-9LMNPQRSTU]{2}[A-Z]{1}[0-9LMNPQRSTU]{3}[A-Z]{1}				

element **Visto_Conformita_Type/Firma**

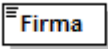
diagram					
namespace	urn:www.agenziaentrate.gov.it:specificheTecniche:sco:common				
type	DatoCB_Type				
facets	<table border="1"> <thead> <tr> <th>Kind</th> <th>Value</th> </tr> </thead> <tbody> <tr> <td>pattern</td> <td>[01]</td> </tr> </tbody> </table>	Kind	Value	pattern	[01]
Kind	Value				
pattern	[01]				

complexType **Scelta2PerMille_Type**

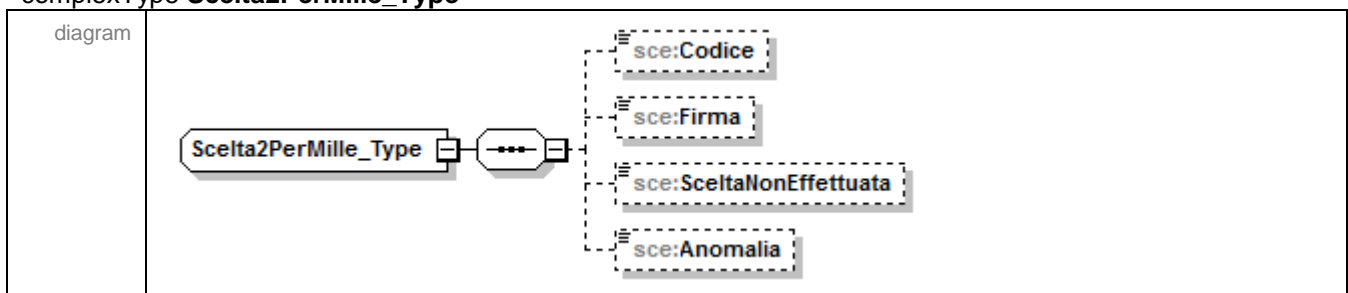

namespace	urn:www.agenziaentrate.gov.it:specificheTecniche:sco:sce
children	sce:Codice sce:Firma sce:SceltaNonEffettuata sce:Anomalia

element **Scelta2PerMille_Type/Codice**

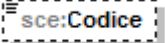
diagram					
namespace	urn:www.agenziaentrate.gov.it:specificheTecniche:sco:sce				
type	DatoAN_Type				
facets	<table border="1"> <tr> <td>Kind</td> <td>Value</td> </tr> <tr> <td>pattern</td> <td>([0-9A-Z\-\&quot;]{1}){([0-9A-Z&amp;:] ! - \., / ° ^\(\ \) À É È Ì Ò Ù Ú Û &quot; \ \\ /+)*</td> </tr> </table>	Kind	Value	pattern	([0-9A-Z\-\"]{1}){([0-9A-Z&:] ! - \., / ° ^\(\ \) À É È Ì Ò Ù Ú Û " \ \\ /+)*
Kind	Value				
pattern	([0-9A-Z\-\"]{1}){([0-9A-Z&:] ! - \., / ° ^\(\ \) À É È Ì Ò Ù Ú Û " \ \\ /+)*				

element **Scelta2PerMille_Type/Firma**

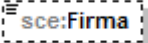
diagram					
namespace	urn:www.agenziaentrate.gov.it:specificheTecniche:sco:sce				
type	DatoCB_Type				
facets	<table border="1"> <tr> <td>Kind</td> <td>Value</td> </tr> <tr> <td>pattern</td> <td>[01]</td> </tr> </table>	Kind	Value	pattern	[01]
Kind	Value				
pattern	[01]				

element **Scelta2PerMille_Type/SceltaNonEffettuata**

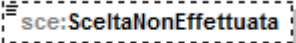
diagram					
namespace	urn:www.agenziaentrate.gov.it:specificheTecniche:sco:sce				
type	DatoCB_Type				
facets	<table border="1"> <tr> <td>Kind</td> <td>Value</td> </tr> <tr> <td>pattern</td> <td>[01]</td> </tr> </table>	Kind	Value	pattern	[01]
Kind	Value				
pattern	[01]				

element **Scelta2PerMille_Type/Anomalia**

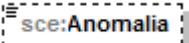
diagram													
namespace	urn:www.agenziaentrate.gov.it:specificheTecniche:sco:sce												
type	restriction of DatoN1_Type												
facets	<table border="1"> <tr> <td>Kind</td> <td>Value</td> </tr> <tr> <td>pattern</td> <td>[1-9]</td> </tr> <tr> <td>enumeration</td> <td>1</td> </tr> <tr> <td>enumeration</td> <td>2</td> </tr> <tr> <td>enumeration</td> <td>3</td> </tr> <tr> <td>enumeration</td> <td>4</td> </tr> </table>	Kind	Value	pattern	[1-9]	enumeration	1	enumeration	2	enumeration	3	enumeration	4
Kind	Value												
pattern	[1-9]												
enumeration	1												
enumeration	2												
enumeration	3												
enumeration	4												

complexType **Scelta2PerMilleAssCult_Type**

diagram	
namespace	urn:www.agenziaentrate.gov.it:specificheTecniche:sco:sce
type	extension of Firma_Type
children	Firma CodiceFiscale sce:SceltaNonEffettuata sce:Anomalia

element **Scelta2PerMilleAssCult_Type/SceltaNonEffettuata**

diagram					
namespace	urn:www.agenziaentrate.gov.it:specificheTecniche:sco:sce				
type	DatoCB_Type				
facets	<table border="1"> <thead> <tr> <th>Kind</th> <th>Value</th> </tr> </thead> <tbody> <tr> <td>pattern</td> <td>[01]</td> </tr> </tbody> </table>	Kind	Value	pattern	[01]
Kind	Value				
pattern	[01]				

element **Scelta2PerMilleAssCult_Type/Anomalia**

diagram													
namespace	urn:www.agenziaentrate.gov.it:specificheTecniche:sco:sce												
type	restriction of DatoN1_Type												
facets	<table border="1"> <thead> <tr> <th>Kind</th> <th>Value</th> </tr> </thead> <tbody> <tr> <td>pattern</td> <td>[1-9]</td> </tr> <tr> <td>enumeration</td> <td>1</td> </tr> <tr> <td>enumeration</td> <td>2</td> </tr> <tr> <td>enumeration</td> <td>4</td> </tr> <tr> <td>enumeration</td> <td>5</td> </tr> </tbody> </table>	Kind	Value	pattern	[1-9]	enumeration	1	enumeration	2	enumeration	4	enumeration	5
Kind	Value												
pattern	[1-9]												
enumeration	1												
enumeration	2												
enumeration	4												
enumeration	5												

complexType **Scelta5PerMille_Type**

diagram	
namespace	urn:www.agenziaentrate.gov.it:specificheTecniche:sco:sce
children	sce:SostegnoVolontariatoNonLucrative sce:RicercaScientifica sce:RicercaSanitaria sce:BeniCulturaliPaesaggistici sce:SostegnoSocialeComune sce:SostegnoAssociazioniSportive sce:SceltaNonEffettuata sce:Anomalia sce:FlagAnomaliaCFbeneficiario

element **Scelta5PerMille_Type/SostegnoVolontariatoNonLucrative**

diagram	
namespace	urn:www.agenziaentrate.gov.it:specificheTecniche:sco:sce
type	Firma_Type
children	Firma CodiceFiscale

element **Scelta5PerMille_Type/RicercaScientifica**

diagram	
namespace	urn:www.agenziaentrate.gov.it:specificheTecniche:sco:sce

type	Firma_Type
children	Firma CodiceFiscale

element **Scelta5PerMille_Type/RicercaSanitaria**

diagram	
namespace	urn:www.agenziaentrate.gov.it:specificheTecniche:sco:sce
type	Firma_Type
children	Firma CodiceFiscale

element **Scelta5PerMille_Type/BeniCulturaliPaesaggistici**

diagram	
namespace	urn:www.agenziaentrate.gov.it:specificheTecniche:sco:sce
children	sce:Firma

element **Scelta5PerMille_Type/BeniCulturaliPaesaggistici/Firma**

diagram	
namespace	urn:www.agenziaentrate.gov.it:specificheTecniche:sco:sce
type	Firma_Type
children	Firma CodiceFiscale

element **Scelta5PerMille_Type/SostegnoSocialeComune**

diagram	
namespace	urn:www.agenziaentrate.gov.it:specificheTecniche:sco:sce
children	sce:Firma

element **Scelta5PerMille_Type/SostegnoSocialeComune/Firma**

diagram					
namespace	urn:www.agenziaentrate.gov.it:specificheTecniche:sco:sce				
type	DatoCB_Type				
facets	<table border="1"> <tr> <td>Kind</td> <td>Value</td> </tr> <tr> <td>pattern</td> <td>[01]</td> </tr> </table>	Kind	Value	pattern	[01]
Kind	Value				
pattern	[01]				

element **Scelta5PerMille_Type/SostegnoAssociazioniSportive**

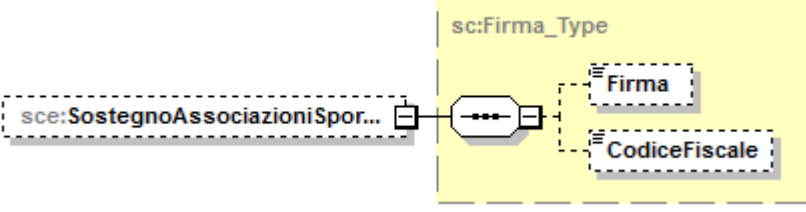
diagram	
namespace	urn:www.agenziaentrate.gov.it:specificheTecniche:sco:sce
type	Firma_Type
children	Firma CodiceFiscale

element **Scelta5PerMille_Type/SceltaNonEffettuata**

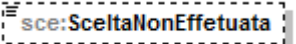
diagram					
namespace	urn:www.agenziaentrate.gov.it:specificheTecniche:sco:sce				
type	DatoCB_Type				
facets	<table border="1"> <tr> <td>Kind</td> <td>Value</td> </tr> <tr> <td>pattern</td> <td>[01]</td> </tr> </table>	Kind	Value	pattern	[01]
Kind	Value				
pattern	[01]				

element **Scelta5PerMille_Type/Anomalia**

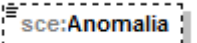
diagram															
namespace	urn:www.agenziaentrate.gov.it:specificheTecniche:sco:sce														
type	restriction of DatoN1_Type														
facets	<table border="1"> <tr> <td>Kind</td> <td>Value</td> </tr> <tr> <td>pattern</td> <td>[1-9]</td> </tr> <tr> <td>enumeration</td> <td>1</td> </tr> <tr> <td>enumeration</td> <td>2</td> </tr> <tr> <td>enumeration</td> <td>3</td> </tr> <tr> <td>enumeration</td> <td>4</td> </tr> <tr> <td>enumeration</td> <td>5</td> </tr> </table>	Kind	Value	pattern	[1-9]	enumeration	1	enumeration	2	enumeration	3	enumeration	4	enumeration	5
Kind	Value														
pattern	[1-9]														
enumeration	1														
enumeration	2														
enumeration	3														
enumeration	4														
enumeration	5														

element **Scelta5PerMille_Type/FlagAnomaliaCFbeneficiario**

diagram	
namespace	urn:www.agenziaentrate.gov.it:specificheTecniche:sco:sce
type	DatoCB_Type
facets	Kind Value pattern [01]

complexType **Scelta8PerMille_Type**

diagram	
namespace	urn:www.agenziaentrate.gov.it:specificheTecniche:sco:sce
children	sce:Stato sce:ChiesaCattolica sce:UnioneChieseCristianeAvventiste7giorno sce:AssembleeDiDiolnItalia sce:UnioneDelleChieseMetodisteValdesi sce:ChiesaEvangelicaLuteranaInItalia sce:UnioneComunitaEbraicheItaliane sce:SacraArcidiocesiOrtodossaEsarcato sce:ChiesaApostolicitalia sce:UnioneCristianaEvangelicaBattista sce:UnioneBuddhistaltaliana sce:UnioneInduistaltaliana sce:IstitutoBuddistalbisg sce:SceltaNonEffettuata sce:Anomalia

element **Scelta8PerMille_Type/Stato**

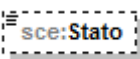
diagram	
namespace	urn:www.agenziaentrate.gov.it:specificheTecniche:sco:sce
type	DatoCB_Type
facets	Kind Value pattern [01]

element **Scelta8PerMille_Type/ChiesaCattolica**

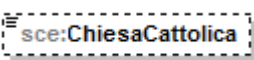
diagram	
namespace	urn:www.agenziaentrate.gov.it:specificheTecniche:sco:sce
type	DatoCB_Type
facets	Kind Value pattern [01]

element **Scelta8PerMille_Type/UnioneChieseCristianeAvventiste7giorno**

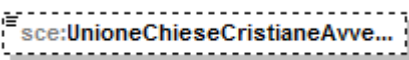
diagram	
namespace	urn:www.agenziaentrate.gov.it:specificheTecniche:sco:sce
type	DatoCB_Type
facets	Kind Value pattern [01]

element **Scelta8PerMille_Type/AssembleeDiDiolnItalia**

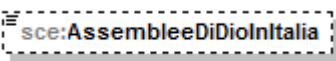
diagram	
namespace	urn:www.agenziaentrate.gov.it:specificheTecniche:sco:sce
type	DatoCB_Type
facets	Kind Value pattern [01]

element **Scelta8PerMille_Type/UnioneDelleChieseMetodisteValdesi**

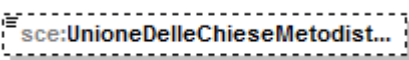
diagram	
namespace	urn:www.agenziaentrate.gov.it:specificheTecniche:sco:sce
type	DatoCB_Type
facets	Kind Value pattern [01]

element **Scelta8PerMille_Type/ChiesaEvangelicaLuteranaInItalia**

diagram	 <code>sce:ChiesaEvangelicaLuteranaIn...</code>
namespace	urn:www.agenziaentrate.gov.it:specificheTecniche:sco:sce
type	DatoCB_Type
facets	Kind Value pattern [01]

element **Scelta8PerMille_Type/UnioneComunitaEbraicheItaliane**

diagram	 <code>sce:UnioneComunitaEbraicheItal...</code>
namespace	urn:www.agenziaentrate.gov.it:specificheTecniche:sco:sce
type	DatoCB_Type
facets	Kind Value pattern [01]

element **Scelta8PerMille_Type/SacraArcidiocesiOrtodossaEsarcato**

diagram	 <code>sce:SacraArcidiocesiOrtodossa...</code>
namespace	urn:www.agenziaentrate.gov.it:specificheTecniche:sco:sce
type	DatoCB_Type
facets	Kind Value pattern [01]

element **Scelta8PerMille_Type/ChiesaApostolicaItalia**

diagram	 <code>sce:ChiesaApostolicaItalia</code>
namespace	urn:www.agenziaentrate.gov.it:specificheTecniche:sco:sce
type	DatoCB_Type
facets	Kind Value pattern [01]

element **Scelta8PerMille_Type/UnioneCristianaEvangelicaBattista**

diagram	 <code>sce:UnioneCristianaEvangelicaB...</code>
namespace	urn:www.agenziaentrate.gov.it:specificheTecniche:sco:sce
type	DatoCB_Type
facets	Kind Value pattern [01]

element **Scelta8PerMille_Type/UnioneBuddhistaltaliana**

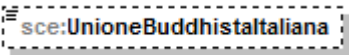
diagram	
namespace	urn:www.agenziaentrate.gov.it:specificheTecniche:sco:sce
type	DatoCB_Type
facets	Kind Value pattern [01]

element **Scelta8PerMille_Type/UnioneInduistaltaliana**

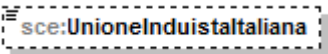
diagram	
namespace	urn:www.agenziaentrate.gov.it:specificheTecniche:sco:sce
type	DatoCB_Type
facets	Kind Value pattern [01]

element **Scelta8PerMille_Type/IstitutoBuddistalbisg**

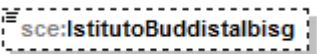
diagram	
namespace	urn:www.agenziaentrate.gov.it:specificheTecniche:sco:sce
type	DatoCB_Type
facets	Kind Value pattern [01]

element **Scelta8PerMille_Type/SceltaNonEffettuata**

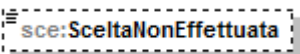
diagram	
namespace	urn:www.agenziaentrate.gov.it:specificheTecniche:sco:sce
type	DatoCB_Type
facets	Kind Value pattern [01]

element **Scelta8PerMille_Type/Anomalia**

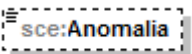
diagram	
namespace	urn:www.agenziaentrate.gov.it:specificheTecniche:sco:sce
type	restriction of DatoN1_Type
facets	Kind Value

	pattern	[1-9]
	enumeration	1
	enumeration	2
	enumeration	3

complexType Scelte_Type

diagram	
namespace	urn:www.agenziaentrate.gov.it:specificheTecniche:sco:sce
children	sce:Scelta5PerMille sce:Scelta8PerMille sce:Scelta2PerMille

element Scelte_Type/Scelta5PerMille

diagram	
namespace	urn:www.agenziaentrate.gov.it:specificheTecniche:sco:sce
type	sce:Scelta5PerMille_Type
children	sce:SostegnoVolontariatoNonLucrative sce:RicercaScientifica sce:RicercaSanitaria sce:BeniCulturaliPaesaggistici sce:SostegnoSocialeComune sce:SostegnoAssociazioniSportive sce:SceltaNonEffettuata sce:Anomalia sce:FlagAnomaliaCFbeneficiario

element **Scelte_Type/Scelta8PerMille**

<p>diagram</p>	
<p>namespace</p>	<p>urn:www.agenziaentrate.gov.it:specificheTecniche:sco:sce</p>
<p>type</p>	<p>sce:Scelta8PerMille_Type</p>
<p>children</p>	<p>sce:Stato sce:ChiesaCattolica sce:UnioneChieseCristianeAvventiste7giorno sce:AssembleeDiDiolnItalia sce:UnioneDelleChieseMetodisteValdesi sce:ChiesaEvangelicaLuteranaInItalia sce:UnioneComunitaEbraicheitaliane sce:SacraArcidiocesiOrtodossaEsarcato sce:ChiesaApostolicaitalia sce:UnioneCristianaEvangelicaBattista sce:UnioneBuddhistaitaliana sce:UnioneInduistaitaliana sce:IstitutoBuddistalbisg sce:SceltaNonEffettuata sce:Anomalia</p>

element **Scelte_Type/Scelta2PerMille**

diagram	
namespace	urn:www.agenziaentrate.gov.it:specificheTecniche:sco:sce
type	sce:Scelta2PerMille_Type
children	sce:Codice sce:Firma sce:SceltaNonEffettuata sce:Anomalia

simpleType **DatoAN_Type**

namespace	urn:www.agenziaentrate.gov.it:specificheTecniche:common				
type	restriction of xs:string				
facets	<table border="1"> <tr> <td>Kind</td> <td>Value</td> </tr> <tr> <td>pattern</td> <td>([0-9A-Z\-\]&quot;){1}([0-9A-Z&amp;:] ' - \., / ° °\°\(\)\ À É É È Ì Ò Ù Ú Û&quot; \\ / +)*</td> </tr> </table>	Kind	Value	pattern	([0-9A-Z\-\]"){1}([0-9A-Z&:] ' - \., / ° °\°\(\)\ À É É È Ì Ò Ù Ú Û" \\ / +)*
Kind	Value				
pattern	([0-9A-Z\-\]"){1}([0-9A-Z&:] ' - \., / ° °\°\(\)\ À É É È Ì Ò Ù Ú Û" \\ / +)*				

simpleType **DatoCB12_Type**

namespace	urn:www.agenziaentrate.gov.it:specificheTecniche:common				
type	restriction of xs:byte				
facets	<table border="1"> <tr> <td>Kind</td> <td>Value</td> </tr> <tr> <td>pattern</td> <td>[10]{12}</td> </tr> </table>	Kind	Value	pattern	[10]{12}
Kind	Value				
pattern	[10]{12}				

simpleType **DatoCB_Type**

namespace	urn:www.agenziaentrate.gov.it:specificheTecniche:common				
type	restriction of xs:byte				
facets	<table border="1"> <tr> <td>Kind</td> <td>Value</td> </tr> <tr> <td>pattern</td> <td>[01]</td> </tr> </table>	Kind	Value	pattern	[01]
Kind	Value				
pattern	[01]				

simpleType **DatoCF_Type**

namespace	urn:www.agenziaentrate.gov.it:specificheTecniche:common				
type	restriction of xs:string				
facets	<table border="1"> <tr> <td>Kind</td> <td>Value</td> </tr> <tr> <td>pattern</td> <td>[0-9]{11}[A-Z]{6}[0-9LMNPQRSTUVWXYZ]{2}[A-Z]{1}[0-9LMNPQRSTUVWXYZ]{2}[A-Z]{1}[0-9LMNPQRSTUVWXYZ]{3}[A-Z]{1}</td> </tr> </table>	Kind	Value	pattern	[0-9]{11}[A-Z]{6}[0-9LMNPQRSTUVWXYZ]{2}[A-Z]{1}[0-9LMNPQRSTUVWXYZ]{2}[A-Z]{1}[0-9LMNPQRSTUVWXYZ]{3}[A-Z]{1}
Kind	Value				
pattern	[0-9]{11}[A-Z]{6}[0-9LMNPQRSTUVWXYZ]{2}[A-Z]{1}[0-9LMNPQRSTUVWXYZ]{2}[A-Z]{1}[0-9LMNPQRSTUVWXYZ]{3}[A-Z]{1}				

simpleType DatoCN_Type

namespace	urn:www.agenziaentrate.gov.it:specificheTecniche:common				
type	restriction of xs:string				
facets	<table border="1"> <tr> <td>Kind</td> <td>Value</td> </tr> <tr> <td>pattern</td> <td>[0-9]{11}</td> </tr> </table>	Kind	Value	pattern	[0-9]{11}
Kind	Value				
pattern	[0-9]{11}				

simpleType DatoCP_Type

namespace	urn:www.agenziaentrate.gov.it:specificheTecniche:common				
type	restriction of xs:string				
facets	<table border="1"> <tr> <td>Kind</td> <td>Value</td> </tr> <tr> <td>pattern</td> <td>[0-9]{5}</td> </tr> </table>	Kind	Value	pattern	[0-9]{5}
Kind	Value				
pattern	[0-9]{5}				

simpleType DatoD6_Type

namespace	urn:www.agenziaentrate.gov.it:specificheTecniche:common				
type	restriction of xs:string				
facets	<table border="1"> <tr> <td>Kind</td> <td>Value</td> </tr> <tr> <td>pattern</td> <td>((0[0-9]) (1[0-2]))((19 20)[0-9][0-9])</td> </tr> </table>	Kind	Value	pattern	((0[0-9]) (1[0-2]))((19 20)[0-9][0-9])
Kind	Value				
pattern	((0[0-9]) (1[0-2]))((19 20)[0-9][0-9])				

simpleType DatoDA_Type

namespace	urn:www.agenziaentrate.gov.it:specificheTecniche:common				
type	restriction of xs:string				
facets	<table border="1"> <tr> <td>Kind</td> <td>Value</td> </tr> <tr> <td>pattern</td> <td>(18 19 20)[0-9]{2}</td> </tr> </table>	Kind	Value	pattern	(18 19 20)[0-9]{2}
Kind	Value				
pattern	(18 19 20)[0-9]{2}				

simpleType DatoDN_Type

namespace	urn:www.agenziaentrate.gov.it:specificheTecniche:common				
type	restriction of xs:string				
facets	<table border="1"> <tr> <td>Kind</td> <td>Value</td> </tr> <tr> <td>pattern</td> <td>(((0[1-9][12][0-9]3[01])(0[13578]10 12)\d{4})) ((0[1-9][12][0-9]30)(0[469]11)\d{4})) ((0[1-9]1[0-9]2[0-8])(02)\d{4})) ((29)(02)([02468][048]00)) ((29)(02)([13579][26]00)) ((29)(02)([0-9][0-9][0][48])) ((29)(02)([0-9][0-9][2468][048])) ((29)(02)([0-9][0-9][13579][26]))</td> </tr> </table>	Kind	Value	pattern	(((0[1-9][12][0-9]3[01])(0[13578]10 12)\d{4})) ((0[1-9][12][0-9]30)(0[469]11)\d{4})) ((0[1-9]1[0-9]2[0-8])(02)\d{4})) ((29)(02)([02468][048]00)) ((29)(02)([13579][26]00)) ((29)(02)([0-9][0-9][0][48])) ((29)(02)([0-9][0-9][2468][048])) ((29)(02)([0-9][0-9][13579][26]))
Kind	Value				
pattern	(((0[1-9][12][0-9]3[01])(0[13578]10 12)\d{4})) ((0[1-9][12][0-9]30)(0[469]11)\d{4})) ((0[1-9]1[0-9]2[0-8])(02)\d{4})) ((29)(02)([02468][048]00)) ((29)(02)([13579][26]00)) ((29)(02)([0-9][0-9][0][48])) ((29)(02)([0-9][0-9][2468][048])) ((29)(02)([0-9][0-9][13579][26]))				

simpleType DatoDT_Type

namespace	urn:www.agenziaentrate.gov.it:specificheTecniche:common				
type	restriction of xs:string				
facets	<table border="1"> <tr> <td>Kind</td> <td>Value</td> </tr> <tr> <td>pattern</td> <td>(((0[1-9][12][0-9]3[01])(0[13578]10 12)\d{4})) ((0[1-9][12][0-9]30)(0[469]11)\d{4})) ((0[1-9]1[0-9]2[0-8])(02)\d{4})) ((29)(02)([02468][048]00)) ((29)(02)([13579][26]00)) ((29)(02)([0-9][0-9][0][48])) ((29)(02)([0-9][0-9][2468][048])) ((29)(02)([0-9][0-9][13579][26]))</td> </tr> </table>	Kind	Value	pattern	(((0[1-9][12][0-9]3[01])(0[13578]10 12)\d{4})) ((0[1-9][12][0-9]30)(0[469]11)\d{4})) ((0[1-9]1[0-9]2[0-8])(02)\d{4})) ((29)(02)([02468][048]00)) ((29)(02)([13579][26]00)) ((29)(02)([0-9][0-9][0][48])) ((29)(02)([0-9][0-9][2468][048])) ((29)(02)([0-9][0-9][13579][26]))
Kind	Value				
pattern	(((0[1-9][12][0-9]3[01])(0[13578]10 12)\d{4})) ((0[1-9][12][0-9]30)(0[469]11)\d{4})) ((0[1-9]1[0-9]2[0-8])(02)\d{4})) ((29)(02)([02468][048]00)) ((29)(02)([13579][26]00)) ((29)(02)([0-9][0-9][0][48])) ((29)(02)([0-9][0-9][2468][048])) ((29)(02)([0-9][0-9][13579][26]))				

simpleType DatoEM_Type

namespace	urn:www.agenziaentrate.gov.it:specificheTecniche:common
-----------	---

type	restriction of xs:string				
facets	<table border="1"> <tr> <td>Kind</td> <td>Value</td> </tr> <tr> <td>pattern</td> <td>[a-zA-Z0-9._%'\-&quot;?^~=]+@[a-zA-Z0-9.\-]+\.[a-zA-Z]{2,4}</td> </tr> </table>	Kind	Value	pattern	[a-zA-Z0-9._%'\-"?^~=]+@[a-zA-Z0-9.\-]+\.[a-zA-Z]{2,4}
Kind	Value				
pattern	[a-zA-Z0-9._%'\-"?^~=]+@[a-zA-Z0-9.\-]+\.[a-zA-Z]{2,4}				

simpleType **DatoGA_Type**

namespace	urn:www.agenziaentrate.gov.it:specificheTecniche:common				
type	restriction of xs:string				
facets	<table border="1"> <tr> <td>Kind</td> <td>Value</td> </tr> <tr> <td>pattern</td> <td>[1-9]((1-9)[0-9]) ((12)[0-9][0-9]) (3[0-5][0-9]) (36[0-5])</td> </tr> </table>	Kind	Value	pattern	[1-9]((1-9)[0-9]) ((12)[0-9][0-9]) (3[0-5][0-9]) (36[0-5])
Kind	Value				
pattern	[1-9]((1-9)[0-9]) ((12)[0-9][0-9]) (3[0-5][0-9]) (36[0-5])				

simpleType **DatoN1_Type**

namespace	urn:www.agenziaentrate.gov.it:specificheTecniche:common				
type	restriction of xs:string				
facets	<table border="1"> <tr> <td>Kind</td> <td>Value</td> </tr> <tr> <td>pattern</td> <td>[1-9]</td> </tr> </table>	Kind	Value	pattern	[1-9]
Kind	Value				
pattern	[1-9]				

simpleType **DatoNP_Type**

namespace	urn:www.agenziaentrate.gov.it:specificheTecniche:common				
type	restriction of xs:string				
facets	<table border="1"> <tr> <td>Kind</td> <td>Value</td> </tr> <tr> <td>pattern</td> <td>[1-9]{1}[0-9]*</td> </tr> </table>	Kind	Value	pattern	[1-9]{1}[0-9]*
Kind	Value				
pattern	[1-9]{1}[0-9]*				

simpleType **DatoNU_Type**

namespace	urn:www.agenziaentrate.gov.it:specificheTecniche:common				
type	restriction of xs:string				
facets	<table border="1"> <tr> <td>Kind</td> <td>Value</td> </tr> <tr> <td>pattern</td> <td>(\[1-9][1-9])[0-9]*</td> </tr> </table>	Kind	Value	pattern	(\[1-9][1-9])[0-9]*
Kind	Value				
pattern	(\[1-9][1-9])[0-9]*				

simpleType **DatoPC_Type**

namespace	urn:www.agenziaentrate.gov.it:specificheTecniche:common				
type	restriction of xs:string				
facets	<table border="1"> <tr> <td>Kind</td> <td>Value</td> </tr> <tr> <td>pattern</td> <td>[0-9]?[0-9](,\d{1,3})? 100(,0{1,3})?</td> </tr> </table>	Kind	Value	pattern	[0-9]?[0-9](,\d{1,3})? 100(,0{1,3})?
Kind	Value				
pattern	[0-9]?[0-9](,\d{1,3})? 100(,0{1,3})?				

simpleType **DatoPI_Type**

namespace	urn:www.agenziaentrate.gov.it:specificheTecniche:common				
type	restriction of xs:string				
facets	<table border="1"> <tr> <td>Kind</td> <td>Value</td> </tr> <tr> <td>pattern</td> <td>[0-7][0-9]{10}</td> </tr> </table>	Kind	Value	pattern	[0-7][0-9]{10}
Kind	Value				
pattern	[0-7][0-9]{10}				

simpleType **DatoQU_Type**

namespace	urn:www.agenziaentrate.gov.it:specificheTecniche:common				
type	restriction of xs:string				
facets	<table border="1"> <thead> <tr> <th>Kind</th> <th>Value</th> </tr> </thead> <tbody> <tr> <td>pattern</td> <td>[0-9]+,[0-9]{1,5)?</td> </tr> </tbody> </table>	Kind	Value	pattern	[0-9]+,[0-9]{1,5)?
Kind	Value				
pattern	[0-9]+,[0-9]{1,5)?				

simpleType **DatoTL_Type**

namespace	urn:www.agenziaentrate.gov.it:specificheTecniche:common				
type	restriction of xs:string				
facets	<table border="1"> <thead> <tr> <th>Kind</th> <th>Value</th> </tr> </thead> <tbody> <tr> <td>pattern</td> <td>[0-9]*</td> </tr> </tbody> </table>	Kind	Value	pattern	[0-9]*
Kind	Value				
pattern	[0-9]*				

simpleType **DatoVP_Type**

namespace	urn:www.agenziaentrate.gov.it:specificheTecniche:common				
type	restriction of xs:string				
facets	<table border="1"> <thead> <tr> <th>Kind</th> <th>Value</th> </tr> </thead> <tbody> <tr> <td>pattern</td> <td>[0-9]+,[0-9]{2}</td> </tr> </tbody> </table>	Kind	Value	pattern	[0-9]+,[0-9]{2}
Kind	Value				
pattern	[0-9]+,[0-9]{2}				

simpleType **Casella_Quadro_Type**

namespace	urn:www.agenziaentrate.gov.it:specificheTecniche:sco:common												
type	restriction of DatoAN_Type												
facets	<table border="1"> <thead> <tr> <th>Kind</th> <th>Value</th> </tr> </thead> <tbody> <tr> <td>pattern</td> <td>([0-9A-Z\-\-] &quot;){1}([0-9A-Z&amp;] ' \" \- . \, / \° \^ \(\) \À \È \É \ \Ò \Ù \Ü &quot; \ \\ \ +)*</td> </tr> <tr> <td>enumeration</td> <td>0</td> </tr> <tr> <td>enumeration</td> <td>1</td> </tr> <tr> <td>enumeration</td> <td>2</td> </tr> <tr> <td>enumeration</td> <td>3</td> </tr> </tbody> </table>	Kind	Value	pattern	([0-9A-Z\-\-] "){1}([0-9A-Z&] ' \" \- . \, / \° \^ \(\) \À \È \É \ \Ò \Ù \Ü " \ \\ \ +)*	enumeration	0	enumeration	1	enumeration	2	enumeration	3
Kind	Value												
pattern	([0-9A-Z\-\-] "){1}([0-9A-Z&] ' \" \- . \, / \° \^ \(\) \À \È \É \ \Ò \Ù \Ü " \ \\ \ +)*												
enumeration	0												
enumeration	1												
enumeration	2												
enumeration	3												

simpleType **Codice_Carica_Type**

namespace	urn:www.agenziaentrate.gov.it:specificheTecniche:sco:common																																		
type	restriction of DatoNP_Type																																		
facets	<table border="1"> <thead> <tr> <th>Kind</th> <th>Value</th> </tr> </thead> <tbody> <tr> <td>pattern</td> <td>[1-9]{1}[0-9]*</td> </tr> <tr> <td>enumeration</td> <td>1</td> </tr> <tr> <td>enumeration</td> <td>2</td> </tr> <tr> <td>enumeration</td> <td>3</td> </tr> <tr> <td>enumeration</td> <td>4</td> </tr> <tr> <td>enumeration</td> <td>5</td> </tr> <tr> <td>enumeration</td> <td>6</td> </tr> <tr> <td>enumeration</td> <td>7</td> </tr> <tr> <td>enumeration</td> <td>8</td> </tr> <tr> <td>enumeration</td> <td>9</td> </tr> <tr> <td>enumeration</td> <td>10</td> </tr> <tr> <td>enumeration</td> <td>11</td> </tr> <tr> <td>enumeration</td> <td>12</td> </tr> <tr> <td>enumeration</td> <td>13</td> </tr> <tr> <td>enumeration</td> <td>14</td> </tr> <tr> <td>enumeration</td> <td>15</td> </tr> </tbody> </table>	Kind	Value	pattern	[1-9]{1}[0-9]*	enumeration	1	enumeration	2	enumeration	3	enumeration	4	enumeration	5	enumeration	6	enumeration	7	enumeration	8	enumeration	9	enumeration	10	enumeration	11	enumeration	12	enumeration	13	enumeration	14	enumeration	15
Kind	Value																																		
pattern	[1-9]{1}[0-9]*																																		
enumeration	1																																		
enumeration	2																																		
enumeration	3																																		
enumeration	4																																		
enumeration	5																																		
enumeration	6																																		
enumeration	7																																		
enumeration	8																																		
enumeration	9																																		
enumeration	10																																		
enumeration	11																																		
enumeration	12																																		
enumeration	13																																		
enumeration	14																																		
enumeration	15																																		

simpleType Codice_Regione_Type

namespace	urn:www.agenziaentrate.gov.it:specificheTecniche:sco:common	
type	restriction of DatoAN_Type	
facets	Kind	Value
	pattern	[(0-9A-Z-] "){1}([0-9A-Z&] ' \" \\. / ° \\^\\(\\) À È É Ì Ò Ù Ü " \\ \\ \\ +)*
	enumeration	1
	enumeration	2
	enumeration	3
	enumeration	4
	enumeration	5
	enumeration	6
	enumeration	7
	enumeration	8
	enumeration	9
	enumeration	10
	enumeration	11
	enumeration	12
	enumeration	13
	enumeration	14
	enumeration	15
	enumeration	16
	enumeration	17
	enumeration	18
	enumeration	19
	enumeration	20
	enumeration	21

simpleType Natura_Giuridica_Type

namespace	urn:www.agenziaentrate.gov.it:specificheTecniche:sco:common	
type	restriction of DatoNP_Type	
facets	Kind	Value
	pattern	[1-9]{1}[0-9]*
	enumeration	1
	enumeration	2
	enumeration	3
	enumeration	4
	enumeration	5
	enumeration	6
	enumeration	7
	enumeration	8
	enumeration	9
	enumeration	10
	enumeration	11
	enumeration	12
	enumeration	13
	enumeration	14
	enumeration	15
	enumeration	16
	enumeration	17
	enumeration	18
	enumeration	19
	enumeration	20
	enumeration	21
	enumeration	22
	enumeration	23
	enumeration	24
	enumeration	25
	enumeration	26
	enumeration	27
	enumeration	28
	enumeration	29

	enumeration	30
	enumeration	31
	enumeration	32
	enumeration	33
	enumeration	34
	enumeration	35
	enumeration	36
	enumeration	37
	enumeration	38
	enumeration	39
	enumeration	40
	enumeration	41
	enumeration	42
	enumeration	43
	enumeration	44
	enumeration	45
	enumeration	50
	enumeration	51
	enumeration	52
	enumeration	53
	enumeration	54
	enumeration	55
	enumeration	56
	enumeration	57
	enumeration	58
	enumeration	59

simpleType Sesso_Type

namespace	urn:www.agenziaentrate.gov.it:specificheTecniche:sco:common	
type	restriction of DatoAN_Type	
facets	Kind	Value
	pattern	[(0-9A-Z-] "){1}([0-9A-Z&] ' \" \. , /° °\ °\(\) À É É ì ò ù ü " \\ / +)*
	enumeration	M
	enumeration	F

simpleType Situazione_Type

namespace	urn:www.agenziaentrate.gov.it:specificheTecniche:sco:common	
type	restriction of DatoNP_Type	
facets	Kind	Value
	pattern	[1-9]{1}[0-9]*
	enumeration	1
	enumeration	2
	enumeration	3
	enumeration	4
	enumeration	5
	enumeration	6
	enumeration	7

simpleType Stato_Type

namespace	urn:www.agenziaentrate.gov.it:specificheTecniche:sco:common	
type	restriction of DatoNP_Type	
facets	Kind	Value
	pattern	[1-9]{1}[0-9]*
	enumeration	1
	enumeration	2
	enumeration	3

	enumeration 4
--	---------------

simpleType **Eventi_Ecc_Type**

namespace	urn:www.agenziaentrategov.it:specificheTecniche:sco:common										
type	restriction of xs:string										
facets	<table border="1"> <thead> <tr> <th>Kind</th> <th>Value</th> </tr> </thead> <tbody> <tr> <td>enumeration</td> <td>1</td> </tr> <tr> <td>enumeration</td> <td>2</td> </tr> <tr> <td>enumeration</td> <td>3</td> </tr> <tr> <td>enumeration</td> <td>4</td> </tr> </tbody> </table>	Kind	Value	enumeration	1	enumeration	2	enumeration	3	enumeration	4
Kind	Value										
enumeration	1										
enumeration	2										
enumeration	3										
enumeration	4										

simpleType **Estero**

namespace	urn:www.agenziaentrategov.it:specificheTecniche:common				
type	restriction of xs:string				
facets	<table border="1"> <thead> <tr> <th>Kind</th> <th>Value</th> </tr> </thead> <tbody> <tr> <td>enumeration</td> <td>EE</td> </tr> </tbody> </table>	Kind	Value	enumeration	EE
Kind	Value				
enumeration	EE				

simpleType **PE_Type**

namespace	urn:www.agenziaentrategov.it:specificheTecniche:common
type	union of (Provincieltaliane , Estero)

simpleType **PN_Type**

namespace	urn:www.agenziaentrategov.it:specificheTecniche:common
type	union of (Provincieltaliane , ProvinciaCroate , Estero , ProvinciaSoppresse)

simpleType **PR_Type**

namespace	urn:www.agenziaentrategov.it:specificheTecniche:common
type	union of (Provincieltaliane)

simpleType **ProvinciaCroate**

namespace	urn:www.agenziaentrategov.it:specificheTecniche:common								
type	restriction of xs:string								
facets	<table border="1"> <thead> <tr> <th>Kind</th> <th>Value</th> </tr> </thead> <tbody> <tr> <td>enumeration</td> <td>FU</td> </tr> <tr> <td>enumeration</td> <td>PL</td> </tr> <tr> <td>enumeration</td> <td>ZA</td> </tr> </tbody> </table>	Kind	Value	enumeration	FU	enumeration	PL	enumeration	ZA
Kind	Value								
enumeration	FU								
enumeration	PL								
enumeration	ZA								

simpleType **Provincieltaliane**

namespace	urn:www.agenziaentrategov.it:specificheTecniche:common
type	restriction of xs:string

facets	Kind	Value
	enumeration	AG
	enumeration	AL
	enumeration	AN
	enumeration	AO
	enumeration	AP
	enumeration	AQ
	enumeration	AR
	enumeration	AT
	enumeration	AV
	enumeration	BA
	enumeration	BG
	enumeration	BI
	enumeration	BL
	enumeration	BN
	enumeration	BO
	enumeration	BR
	enumeration	BS
	enumeration	BT
	enumeration	BZ
	enumeration	CA
	enumeration	CB
	enumeration	CE
	enumeration	CH
	enumeration	CI
	enumeration	CL
	enumeration	CN
	enumeration	CO
	enumeration	CR
	enumeration	CS
	enumeration	CT
	enumeration	CZ
	enumeration	EN
	enumeration	FC
	enumeration	FE
	enumeration	FG
	enumeration	FI
	enumeration	FM
	enumeration	FR
	enumeration	GE
	enumeration	GO
	enumeration	GR
	enumeration	IM
	enumeration	IS
	enumeration	KR
	enumeration	LC
	enumeration	LE
	enumeration	LI
	enumeration	LO
	enumeration	LT
	enumeration	LU
	enumeration	MB
	enumeration	MC
	enumeration	ME
	enumeration	MI
	enumeration	MN
	enumeration	MO
	enumeration	MS
	enumeration	MT
	enumeration	NA
	enumeration	NO
	enumeration	NU
	enumeration	OG
	enumeration	OR
	enumeration	OT
	enumeration	PA
	enumeration	PC
	enumeration	PD

enumeration	PE
enumeration	PG
enumeration	PI
enumeration	PN
enumeration	PO
enumeration	PR
enumeration	PT
enumeration	PU
enumeration	PV
enumeration	PZ
enumeration	RA
enumeration	RC
enumeration	RE
enumeration	RG
enumeration	RI
enumeration	RM
enumeration	RN
enumeration	RO
enumeration	SA
enumeration	SI
enumeration	SO
enumeration	SP
enumeration	SR
enumeration	SS
enumeration	SV
enumeration	TA
enumeration	TE
enumeration	TN
enumeration	TO
enumeration	TP
enumeration	TR
enumeration	TS
enumeration	TV
enumeration	UD
enumeration	VA
enumeration	VB
enumeration	VC
enumeration	VE
enumeration	VI
enumeration	VR
enumeration	VS
enumeration	VT
enumeration	VV

simpleType **ProvinciaSoppresse**

namespace	urn:www.agenziaentrate.gov.it:specificheTecniche:common	
type	restriction of xs:string	
facets	Kind	Value
	enumeration	FO
	enumeration	PS