

## **ALLEGATO B**

**Specifiche tecniche per la trasmissione  
dei modelli 730-4/2018 e 730-4/2018 integrativo  
all'INPS**

# SPECIFICHE TECNICHE PER LA TRASMISSIONE DELLE COMUNICAZIONI RELATIVE AL RISULTATO CONTABILE CHE I CENTRI DI ASSISTENZA FISCALE ED I PROFESSIONISTI ABILITATI DEVONO INVIARE ALL'INPS (MODELLO 730-4 E 730-4 INTEGRATIVO)

## 1. AVVERTENZE GENERALI

I CAF dipendenti e i professionisti abilitati sono tenuti ad inviare, in via telematica, all'INPS la comunicazione con l'esito contabile delle dichiarazioni ai fini del conguaglio, a credito o a debito, da effettuare in sede di ritenuta d'acconto.

**Il linguaggio adottato è quello XML** (eXtensible Markup Language).

L'XML è un metalinguaggio, ossia una “grammatica”, per la definizione di documenti da gestire con strumenti informatici. Per “grammatica” si intende l'insieme standard di definizioni e di regole sintattiche mediante le quali la struttura logica di un documento viene tradotta in una corrispondente struttura fisica, composta di elementi sintattici chiamati **tag**, ossia sequenze di caratteri delimitate dai segni '<' e '>'.

Concretamente, un file XML è un file di testo costituito da diversi **elementi** individuati dai **tag**, ciascuno dei quali identifica un componente logico del documento.

Gli **elementi** sono organizzati secondo una **struttura gerarchica**: ciascun **elemento** può infatti contenere altri elementi (**sottoelementi**) oppure del testo. L'elemento principale della struttura “ad albero” così ottenuta è denominato **radice (root element)**.

La fornitura oggetto della trasmissione telematica deve essere conforme alle specifiche dell'eXtensible Markup Language (XML) 1.0 (raccomandazione WC3 10 febbraio 1998) e deve essere codificata secondo la codifica UTF-8.

Il contenuto della fornitura xml, deve inoltre soddisfare la sintassi descritta nel file XSD denominato “**fornitura734\_Inps\_2018\_v1.xsd**”, allegato al presente documento.

## Schema fornitura734\_Inps\_2018\_v1.xsd

schema location: **fornitura734\_Inps\_2018\_v1.xsd**  
 attributeFormDefault: **unqualified**  
 elementFormDefault: **qualified**  
 targetNamespace: **urn:www.agenziaentrate.gov.it:specificheTecniche:sco:730**

Elements

### [FornituraInps730-4](#)

#### element FornituraInps730-4

diagram	
namespace	urn:www.agenziaentrate.gov.it:specificheTecniche:sco:730
children	<a href="#">m730:Intestazione</a> <a href="#">m730:Documento_730-4</a>

#### element FornituraInps730-4/Intestazione

diagram	
namespace	urn:www.agenziaentrate.gov.it:specificheTecniche:sco:730
children	<a href="#">m730:CodiceFornitura</a> <a href="#">m730:TotaleDocumenti</a> <a href="#">m730:CodiceFiscaleSostituto</a> <a href="#">m730:SoggettoAssFiscale730-4</a> <a href="#">m730:Informazioni Servizio</a>

#### element FornituraInps730-4/Intestazione/CodiceFornitura

diagram	
namespace	urn:www.agenziaentrate.gov.it:specificheTecniche:sco:730

type	<a href="#">DatoAN Type</a>
facets	Kind Value pattern ([0-9A-Z\-\_]&quot;){1}([ 0-9A-Z&amp;:] ' - \. , / ° °\ (\ )À É È Ò Ù Û &quot; \ \\ +)*

element **FornituraInps730-4/Intestazione/TotaleDocumenti**

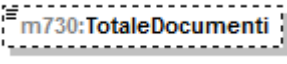
diagram	
namespace	urn:www.agenziaentrate.gov.it:specificheTecniche:sco:730
type	<a href="#">DatoNP Type</a>
facets	Kind Value pattern [1-9]{1}[0-9]*

element **FornituraInps730-4/Intestazione/CodiceFiscaleSostituto**

diagram	
namespace	urn:www.agenziaentrate.gov.it:specificheTecniche:sco:730
type	<a href="#">DatoCN Type</a>
facets	Kind Value pattern [0-9]{11}

element **FornituraInps730-4/Intestazione/SoggettoAssFiscale730-4**

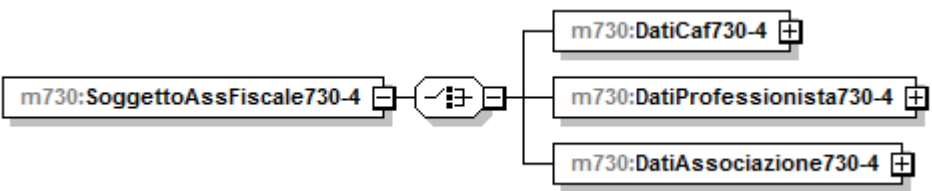
diagram	
namespace	urn:www.agenziaentrate.gov.it:specificheTecniche:sco:730
children	<a href="#">m730:DatiCaf730-4</a> <a href="#">m730:DatiProfessionista730-4</a> <a href="#">m730:DatiAssociazione730-4</a>

element FornituraInps730-4/Intestazione/SoggettoAssFiscale730-4/DatiCaf730-4

diagram	<p>The diagram shows a class <code>m730:DatiCaf730-4</code> extending the class <code>m730:Dati_CAF_Type (extension)</code>. The extension includes the following elements: <code>m730:CFCaf</code>, <code>m730:DenominazioneCaf</code>, <code>m730:NumeroAlbo</code>, <code>m730:DomicilioCaf</code>, and <code>m730:UfficioPerifericoCaf</code>.</p>
namespace	urn:www.agenziaentrate.gov.it:specificheTecniche:sco:730
type	extension of <a href="#">m730:Dati_CAF_Type</a>
children	<a href="#">m730:CFCaf</a> <a href="#">m730:DenominazioneCaf</a> <a href="#">m730:NumeroAlbo</a> <a href="#">m730:DomicilioCaf</a> <a href="#">m730:UfficioPerifericoCaf</a>

element FornituraInps730-4/Intestazione/SoggettoAssFiscale730-4/DatiCaf730-4/DomicilioCaf

diagram	<p>The diagram shows a class <code>m730:DomicilioCaf</code> extending the class <code>m730:Domicilio_Sogg_Ass_Fiscale_Type</code>. The extension includes the following elements: <code>m730:Comune</code>, <code>m730:Provincia</code>, <code>m730:CodiceComune</code>, <code>m730:Cap</code>, <code>m730:Indirizzo</code>, <code>m730:Telefono</code>, <code>m730:FAX</code>, and <code>m730:Email</code>.</p>
namespace	urn:www.agenziaentrate.gov.it:specificheTecniche:sco:730
type	<a href="#">m730:Domicilio_Sogg_Ass_Fiscale_Type</a>
children	<a href="#">m730:Comune</a> <a href="#">m730:Provincia</a> <a href="#">m730:CodiceComune</a> <a href="#">m730:Cap</a> <a href="#">m730:Indirizzo</a> <a href="#">m730:Telefono</a> <a href="#">m730:FAX</a> <a href="#">m730:Email</a>

element **FornituraInps730-4/Intestazione/SoggettoAssFiscale730-4/DatiCaf730-4/UfficioPerifericoCaf**

diagram	
namespace	urn:www.agenziaentrate.gov.it:specificheTecniche:sco:730
children	<a href="#">m730:DomicilioUffPeriferico</a>

element **FornituraInps730-4/Intestazione/SoggettoAssFiscale730-4/DatiCaf730-4/UfficioPerifericoCaf/DomicilioUffPeriferico**

diagram	
namespace	urn:www.agenziaentrate.gov.it:specificheTecniche:sco:730
type	extension of <a href="#">m730:Domicilio Sogg Ass Fiscale Type</a>
children	<a href="#">m730:Comune</a> <a href="#">m730:Provincia</a> <a href="#">m730:CodiceComune</a> <a href="#">m730:Cap</a> <a href="#">m730:Indirizzo</a> <a href="#">m730:Telefono</a> <a href="#">m730:FAX</a> <a href="#">m730:Email</a> <a href="#">m730:CodiceSedePeriferica</a>

element **FornituraInps730-4/Intestazione/SoggettoAssFiscale730-4/DatiCaf730-4/UfficioPerifericoCaf/DomicilioUffPeriferico/CodiceSedePeriferica**

diagram					
namespace	urn:www.agenziaentrate.gov.it:specificheTecniche:sco:730				
type	<a href="#">DatoAN Type</a>				
facets	<table border="0"> <tr> <td>Kind</td> <td>Value</td> </tr> <tr> <td>pattern</td> <td>([0-9A-Z-] \&amp;quot;){1}([0-9A-Z&amp;amp;:] ' \- \., / ^°\^\(\ \) À È É Ì Ò Ù Û &amp;quot; \ \\ / +)*</td> </tr> </table>	Kind	Value	pattern	([0-9A-Z-] \&quot;){1}([0-9A-Z&amp;:] ' \- \., / ^°\^\(\ \) À È É Ì Ò Ù Û &quot; \ \\ / +)*
Kind	Value				
pattern	([0-9A-Z-] \&quot;){1}([0-9A-Z&amp;:] ' \- \., / ^°\^\(\ \) À È É Ì Ò Ù Û &quot; \ \\ / +)*				

element **FornituraInps730-4/Intestazione/SoggettoAssFiscale730-4/DatiProfessionista730-4**

diagram	<p>The diagram shows a class <code>m730:DatiProfessionista730-4</code> extending the class <code>m730:Dati_Professionista_Type (extension)</code>. The extension includes four child elements: <code>m730:CFProfessionista</code>, <code>m730:CognomeProfessionista</code>, <code>m730:NomeProfessionista</code>, and <code>m730:DomicilioProf</code>.</p>
namespace	urn:www.agenziaentrate.gov.it:specificheTecniche:sco:730
type	extension of <a href="#">m730:Dati Professionista Type</a>
children	<a href="#">m730:CFProfessionista</a> <a href="#">m730:CognomeProfessionista</a> <a href="#">m730:NomeProfessionista</a> <a href="#">m730:DomicilioProf</a>

element **FornituraInps730-4/Intestazione/SoggettoAssFiscale730-4/DatiProfessionista730-4/DomicilioProf**

diagram	<p>The diagram shows a class <code>m730:DomicilioProf</code> extending the class <code>m730:Domicilio_Sogg_Ass_Fiscale_Type</code>. The extension includes eight child elements: <code>m730:Comune</code>, <code>m730:Provincia</code>, <code>m730:CodiceComune</code>, <code>m730:Cap</code>, <code>m730:Indirizzo</code>, <code>m730:Telefono</code>, <code>m730:FAX</code>, and <code>m730:Email</code>.</p>
namespace	urn:www.agenziaentrate.gov.it:specificheTecniche:sco:730
type	<a href="#">m730:Domicilio Sogg Ass Fiscale Type</a>
children	<a href="#">m730:Comune</a> <a href="#">m730:Provincia</a> <a href="#">m730:CodiceComune</a> <a href="#">m730:Cap</a> <a href="#">m730:Indirizzo</a> <a href="#">m730:Telefono</a> <a href="#">m730:FAX</a> <a href="#">m730:Email</a>

element **FornituraInps730-4/Intestazione/SoggettoAssFiscale730-4/DatiAssociazione730-4**

<p>diagram</p>	<p>The diagram shows a class <code>m730:DatiAssociazione730-4</code> extending the class <code>m730:Dati_Associazioni_Professionale_Type</code> (indicated as an extension). The extension includes the following elements: <code>m730:CFAssociazione</code>, <code>m730:DenominazioneAssociazione</code>, <code>m730:CFProfessionista</code>, <code>m730:CognomeProfessionista</code>, <code>m730:NomeProfessionista</code>, and <code>m730:DomicilioAssociazione</code>.</p>
<p>namespace</p>	<p>urn:www.agenziaentrate.gov.it:specificheTecniche:sco:730</p>
<p>type</p>	<p>extension of <a href="#">m730:Dati_Associazioni_Professionale_Type</a></p>
<p>children</p>	<p><a href="#">m730:CFAssociazione</a> <a href="#">m730:DenominazioneAssociazione</a> <a href="#">m730:CFProfessionista</a> <a href="#">m730:CognomeProfessionista</a> <a href="#">m730:NomeProfessionista</a> <a href="#">m730:DomicilioAssociazione</a></p>

element **FornituraInps730-4/Intestazione/SoggettoAssFiscale730-4/DatiAssociazione730-4/DomicilioAssociazione**

<p>diagram</p>	<p>The diagram shows a class <code>m730:DomicilioAssociazione</code> extending the class <code>m730:Domicilio_Sogg_Ass_Fiscale_Type</code> (indicated as an extension). The extension includes the following elements: <code>m730:Comune</code>, <code>m730:Provincia</code>, <code>m730:CodiceComune</code>, <code>m730:Cap</code>, <code>m730:Indirizzo</code>, <code>m730:Telefono</code>, <code>m730:FAX</code>, and <code>m730:Email</code>.</p>
<p>namespace</p>	<p>urn:www.agenziaentrate.gov.it:specificheTecniche:sco:730</p>
<p>type</p>	<p><a href="#">m730:Domicilio_Sogg_Ass_Fiscale_Type</a></p>
<p>children</p>	<p><a href="#">m730:Comune</a> <a href="#">m730:Provincia</a> <a href="#">m730:CodiceComune</a> <a href="#">m730:Cap</a> <a href="#">m730:Indirizzo</a> <a href="#">m730:Telefono</a> <a href="#">m730:FAX</a> <a href="#">m730:Email</a></p>

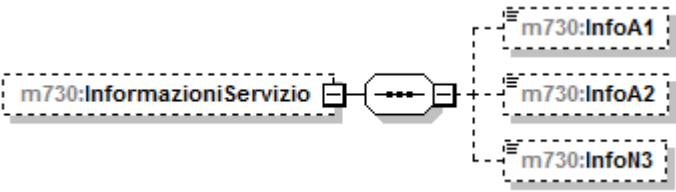

**element FornituraInps730-4/Intestazione/InformazioniServizio**

diagram	
namespace	urn:www.agenziaentrate.gov.it:specificheTecniche:sco:730
children	<a href="#">m730:InfoA1</a> <a href="#">m730:InfoA2</a> <a href="#">m730:InfoN3</a>

**element FornituraInps730-4/Intestazione/InformazioniServizio/InfoA1**

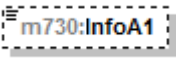
diagram	
namespace	urn:www.agenziaentrate.gov.it:specificheTecniche:sco:730
type	<a href="#">DatoAN_Type</a>
facets	Kind Value pattern ([0-9A-Z\-\_]&quot;){1}([ 0-9A-Z&amp;:] ' - \., / "^\(\)\) À È É Ì Ò Ù Û &quot; \N \+)*

**element FornituraInps730-4/Intestazione/InformazioniServizio/InfoA2**

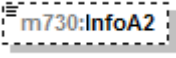
diagram	
namespace	urn:www.agenziaentrate.gov.it:specificheTecniche:sco:730
type	<a href="#">DatoAN_Type</a>
facets	Kind Value pattern ([0-9A-Z\-\_]&quot;){1}([ 0-9A-Z&amp;:] ' - \., / "^\(\)\) À È É Ì Ò Ù Û &quot; \N \+)*

**element FornituraInps730-4/Intestazione/InformazioniServizio/InfoN3**

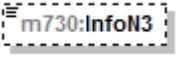
diagram	
namespace	urn:www.agenziaentrate.gov.it:specificheTecniche:sco:730
type	<a href="#">DatoNU_Type</a>
facets	Kind Value pattern (\-[1-9][[1-9]][0-9]*

element **FornituraInps730-4/Documento\_730-4**

diagram	
namespace	urn:www.agenziaentrate.gov.it:specificheTecniche:sco:730
type	<a href="#">m730:Documento_730-4</a>
children	<a href="#">m730:DatiAnagraficiDichiarante</a> <a href="#">m730:Sostituto</a> <a href="#">m730:SoggettoAssFiscale730-4</a> <a href="#">m730:AltriDati</a> <a href="#">m730:DatiContabili730-4</a>

element **Documento730**

diagram	
namespace	urn:www.agenziaentrate.gov.it:specificheTecniche:sco:730

type	<a href="#">m730:Documento 730 Type</a>				
children	<a href="#">m730:DichiarazioneDich</a> <a href="#">m730:DichiarazioneCon</a> <a href="#">m730:AltriDati</a> <a href="#">m730:Sostituto</a> <a href="#">m730:Mod730DipendentiSenzaSostituto</a> <a href="#">m730:SoggettoAssFiscaleDoc</a> <a href="#">m730:Documento 730-4</a> <a href="#">m730:EsitiContabili</a> <a href="#">m730:DatiRettificati</a>				
attributes	Name <a href="#">identificativo</a>	Type <a href="#">Identificativo_Type</a>	Use required	Default	Fixed

### complexType [Acconti\\_Altri\\_Dati\\_Type](#)

diagram	
namespace	urn:www.agenziaentrate.gov.it:specificheTecniche:sco:730
children	<a href="#">m730:IncapientiDetrazioneFigli</a> <a href="#">m730:IncapientiDetrazioneLocazione</a> <a href="#">m730:RestituzioneBonusFiscale</a> <a href="#">m730:RestituzioneBonusStraordinario</a> <a href="#">m730:Pignoramento</a>

### element [Acconti\\_Altri\\_Dati\\_Type/IncapientiDetrazioneFigli](#)

diagram					
namespace	urn:www.agenziaentrate.gov.it:specificheTecniche:sco:730				
type	<a href="#">DatoNP_Type</a>				
facets	<table border="1"> <tr> <td>Kind</td> <td>Value</td> </tr> <tr> <td>pattern</td> <td>[1-9]{1}[0-9]*</td> </tr> </table>	Kind	Value	pattern	[1-9]{1}[0-9]*
Kind	Value				
pattern	[1-9]{1}[0-9]*				

### element [Acconti\\_Altri\\_Dati\\_Type/IncapientiDetrazioneLocazione](#)

diagram					
namespace	urn:www.agenziaentrate.gov.it:specificheTecniche:sco:730				
type	<a href="#">DatoNP_Type</a>				
facets	<table border="1"> <tr> <td>Kind</td> <td>Value</td> </tr> <tr> <td>pattern</td> <td>[1-9]{1}[0-9]*</td> </tr> </table>	Kind	Value	pattern	[1-9]{1}[0-9]*
Kind	Value				
pattern	[1-9]{1}[0-9]*				

### element [Acconti\\_Altri\\_Dati\\_Type/RestituzioneBonusFiscale](#)

diagram	
---------	--

namespace	urn:www.agenziaentrate.gov.it:specificheTecniche:sco:730
type	<a href="#">DatoNP_Type</a>
facets	Kind Value pattern [1-9]{1}[0-9]*

element **Acconti\_Altri\_Dati\_Type/RestituzioneBonusStraordinario**

diagram	
namespace	urn:www.agenziaentrate.gov.it:specificheTecniche:sco:730
type	<a href="#">DatoNP_Type</a>
facets	Kind Value pattern [1-9]{1}[0-9]*

element **Acconti\_Altri\_Dati\_Type/Pignoramento**

diagram	
namespace	urn:www.agenziaentrate.gov.it:specificheTecniche:sco:730
type	<a href="#">m730:Pignoramento_Type</a>
children	<a href="#">m730:TipoRedditoPignoramento</a> <a href="#">m730:RitenutePignoramento</a>

complexType **Acconti\_Irpef\_Anno\_Imposta\_Type**

diagram	
namespace	urn:www.agenziaentrate.gov.it:specificheTecniche:sco:730
children	<a href="#">m730:PrimaRataAccontoIrpef</a> <a href="#">m730:SecondaRataAccontoIrpef</a> <a href="#">m730:AccontoAddComunale</a> <a href="#">m730:PrimaRataAccontoCedolare</a> <a href="#">m730:SecondaRataAccontoCedo...</a>

element **Acconti\_Irpef\_Anno\_Imposta\_Type/PrimaRataAccontolrpef**

diagram	 m730:PrimaRataAccontolrpef
namespace	urn:www.agenziaentrate.gov.it:specificheTecniche:sco:730
type	<a href="#">DatoNP_Type</a>
facets	Kind Value pattern [1-9]{1}[0-9]*

element **Acconti\_Irpef\_Anno\_Imposta\_Type/SecondaRataAccontolrpef**

diagram	 m730:SecondaRataAccontolrpef
namespace	urn:www.agenziaentrate.gov.it:specificheTecniche:sco:730
type	<a href="#">DatoNP_Type</a>
facets	Kind Value pattern [1-9]{1}[0-9]*

element **Acconti\_Irpef\_Anno\_Imposta\_Type/AccontoAddComunale**

diagram	 m730:AccontoAddComunale
namespace	urn:www.agenziaentrate.gov.it:specificheTecniche:sco:730
type	<a href="#">DatoNP_Type</a>
facets	Kind Value pattern [1-9]{1}[0-9]*

element **Acconti\_Irpef\_Anno\_Imposta\_Type/PrimaRataAccontoCedolare**

diagram	 m730:PrimaRataAccontoCedolare
namespace	urn:www.agenziaentrate.gov.it:specificheTecniche:sco:730
type	<a href="#">DatoNP_Type</a>
facets	Kind Value pattern [1-9]{1}[0-9]*

element **Acconti\_Irpef\_Anno\_Imposta\_Type/SecondaRataAccontoCedolare**

diagram	 m730:SecondaRataAccontoCedo...
namespace	urn:www.agenziaentrate.gov.it:specificheTecniche:sco:730
type	<a href="#">DatoNP_Type</a>
facets	Kind Value pattern [1-9]{1}[0-9]*

complexType **Acconti\_Ritenute\_Type**

diagram	
namespace	urn:www.agenziaentrate.gov.it:specificheTecniche:sco:730
children	<a href="#">m730:PrimoModulo</a> <a href="#">m730:Modulo</a>

element **Acconti\_Ritenute\_Type/PrimoModulo**

diagram	
namespace	urn:www.agenziaentrate.gov.it:specificheTecniche:sco:730
type	<a href="#">m730:Primo_Modulo_Acconti_Ritenute_Type</a>
children	<a href="#">m730:Accontilrpef</a> <a href="#">m730:AltreRitenute</a> <a href="#">m730:Eccedenze</a> <a href="#">m730:EccedenzeOltreAnno</a> <a href="#">m730:RitenuteAccontiSospesi</a> <a href="#">m730:MisuraAcconti</a> <a href="#">m730:EsenzioneAddComunale</a> <a href="#">m730:Dati730Integrativo</a> <a href="#">m730:AccontiAltriDati</a> <a href="#">m730:LocazioniBrevi</a>

element **Acconti\_Ritenute\_Type/Modulo**

diagram	
namespace	urn:www.agenziaentrate.gov.it:specificheTecniche:sco:730
children	<a href="#">m730:AltreRitenute</a> <a href="#">m730:EccedenzeOltreAnno</a> <a href="#">m730:Pignoramento</a>

element **Acconti\_Ritenute\_Type/Modulo/AltreRitenute**

diagram	
namespace	urn:www.agenziaentrate.gov.it:specificheTecniche:sco:730
type	<a href="#">m730:Altre Ritenute Type</a>
children	<a href="#">m730:Codice</a> <a href="#">m730:AltreRitenuteIrpef</a> <a href="#">m730:AddizionaleRegionale</a> <a href="#">m730:AddizionaleComunale</a> <a href="#">m730:AddRegionaleIrpefAttivitaSport</a> <a href="#">m730:AddComunaleIrpefAttivitaSport</a> <a href="#">m730:IrpefLavoriSocialmenteUtili</a> <a href="#">m730:AddRegionaleIrpefLavoriSoc. Utili</a>

element **Acconti\_Ritenute\_Type/Modulo/EccedenzeOltreAnno**

diagram	
namespace	urn:www.agenziaentrate.gov.it:specificheTecniche:sco:730
type	<a href="#">m730:Eccedenze_Oltre_Anno_Type</a>
children	<a href="#">m730:Anno</a> <a href="#">m730:Irpef</a> <a href="#">m730:SostitutivaQuadroRT</a> <a href="#">m730:CedolareSecca</a> <a href="#">m730:CodiceRegione</a> <a href="#">m730:AddRegionaleIrpef</a> <a href="#">m730:CodiceCatastaleComune</a> <a href="#">m730:AddComunaleIrpef</a> <a href="#">m730:ImpostaSostitutiva</a>

element **Acconti\_Ritenute\_Type/Modulo/Pignoramento**

diagram	
namespace	urn:www.agenziaentrate.gov.it:specificheTecniche:sco:730
type	<a href="#">m730:Pignoramento_Type</a>
children	<a href="#">m730:TipoRedditoPignoramento</a> <a href="#">m730:RitenutePignoramento</a>



complexType **Acoonti\_Compensati\_Intern\_Type**

diagram	
namespace	urn:www.agenziaentrate.gov.it:specificheTecniche:sco:730
children	<a href="#">m730:PrimaRatalrpef</a> <a href="#">m730:AddizionaleComunale</a> <a href="#">m730:PrimaRataCedolare</a>

element **Acoonti\_Compensati\_Intern\_Type/PrimaRatalrpef**

diagram					
namespace	urn:www.agenziaentrate.gov.it:specificheTecniche:sco:730				
type	<a href="#">DatoNP_Type</a>				
facets	<table border="1"> <tr> <td>Kind</td> <td>Value</td> </tr> <tr> <td>pattern</td> <td>[1-9]{1}[0-9]*</td> </tr> </table>	Kind	Value	pattern	[1-9]{1}[0-9]*
Kind	Value				
pattern	[1-9]{1}[0-9]*				

element **Acoonti\_Compensati\_Intern\_Type/AddizionaleComunale**

diagram					
namespace	urn:www.agenziaentrate.gov.it:specificheTecniche:sco:730				
type	<a href="#">DatoNP_Type</a>				
facets	<table border="1"> <tr> <td>Kind</td> <td>Value</td> </tr> <tr> <td>pattern</td> <td>[1-9]{1}[0-9]*</td> </tr> </table>	Kind	Value	pattern	[1-9]{1}[0-9]*
Kind	Value				
pattern	[1-9]{1}[0-9]*				

element **Acoonti\_Compensati\_Intern\_Type/PrimaRataCedolare**

diagram					
namespace	urn:www.agenziaentrate.gov.it:specificheTecniche:sco:730				
type	<a href="#">DatoNP_Type</a>				
facets	<table border="1"> <tr> <td>Kind</td> <td>Value</td> </tr> <tr> <td>pattern</td> <td>[1-9]{1}[0-9]*</td> </tr> </table>	Kind	Value	pattern	[1-9]{1}[0-9]*
Kind	Value				
pattern	[1-9]{1}[0-9]*				

### complexType **Acquisto\_Costruzione\_Abit\_Type**

diagram	
namespace	urn:www.agenziaentrate.gov.it:specificheTecniche:sco:730
children	<a href="#">m730:DataStipula</a> <a href="#">m730:Spesa</a> <a href="#">m730:InteressiMutuo</a>

### element **Acquisto\_Costruzione\_Abit\_Type/DataStipula**

diagram					
namespace	urn:www.agenziaentrate.gov.it:specificheTecniche:sco:730				
type	<a href="#">DatoDT_Type</a>				
facets	<table border="1"> <thead> <tr> <th>Kind</th> <th>Value</th> </tr> </thead> <tbody> <tr> <td>pattern</td> <td>((([0-9]{12} [0-9]{3}[01]) (0[13578] 10 12)\d{4})) (((0[1-9] 12 [0-9]{30})(0[469] 11)\d{4})) ((0[1-9] 1[0-9] 2[0-8])(02)\d{4})) ((29)(02)([02468][048]00)) ((29)(02)([13579][26]00)) ((29)(02)([0-9][0-9][0-9][0-9][2468][048])) ((29)(02)([0-9][0-9][13579][26]))</td> </tr> </tbody> </table>	Kind	Value	pattern	((([0-9]{12} [0-9]{3}[01]) (0[13578] 10 12)\d{4})) (((0[1-9] 12 [0-9]{30})(0[469] 11)\d{4})) ((0[1-9] 1[0-9] 2[0-8])(02)\d{4})) ((29)(02)([02468][048]00)) ((29)(02)([13579][26]00)) ((29)(02)([0-9][0-9][0-9][0-9][2468][048])) ((29)(02)([0-9][0-9][13579][26]))
Kind	Value				
pattern	((([0-9]{12} [0-9]{3}[01]) (0[13578] 10 12)\d{4})) (((0[1-9] 12 [0-9]{30})(0[469] 11)\d{4})) ((0[1-9] 1[0-9] 2[0-8])(02)\d{4})) ((29)(02)([02468][048]00)) ((29)(02)([13579][26]00)) ((29)(02)([0-9][0-9][0-9][0-9][2468][048])) ((29)(02)([0-9][0-9][13579][26]))				

### element **Acquisto\_Costruzione\_Abit\_Type/Spesa**

diagram					
namespace	urn:www.agenziaentrate.gov.it:specificheTecniche:sco:730				
type	<a href="#">DatoNP_Type</a>				
facets	<table border="1"> <thead> <tr> <th>Kind</th> <th>Value</th> </tr> </thead> <tbody> <tr> <td>pattern</td> <td>[1-9]{1}[0-9]*</td> </tr> </tbody> </table>	Kind	Value	pattern	[1-9]{1}[0-9]*
Kind	Value				
pattern	[1-9]{1}[0-9]*				

### element **Acquisto\_Costruzione\_Abit\_Type/InteressiMutuo**

diagram					
namespace	urn:www.agenziaentrate.gov.it:specificheTecniche:sco:730				
type	<a href="#">DatoNP_Type</a>				
facets	<table border="1"> <thead> <tr> <th>Kind</th> <th>Value</th> </tr> </thead> <tbody> <tr> <td>pattern</td> <td>[1-9]{1}[0-9]*</td> </tr> </tbody> </table>	Kind	Value	pattern	[1-9]{1}[0-9]*
Kind	Value				
pattern	[1-9]{1}[0-9]*				

complexType **Addizionali\_Type**

diagram	
namespace	urn:www.agenziaentrate.gov.it:specificheTecniche:sco:730
children	<a href="#">m730:Imponibile</a> <a href="#">m730:AddRegDovuta</a> <a href="#">m730:AddRegCertif</a> <a href="#">m730:EccedenzaAddReg</a> <a href="#">m730:AddComDovuta</a> <a href="#">m730:AddComCertif</a> <a href="#">m730:EccedenzaAddCom</a> <a href="#">m730:AccontoAddCom</a> <a href="#">m730:AccontoAddComCertif</a>

element **Addizionali\_Type/Imponibile**

diagram					
namespace	urn:www.agenziaentrate.gov.it:specificheTecniche:sco:730				
type	<a href="#">DatoNP_Type</a>				
facets	<table border="1"> <tr> <td>Kind</td> <td>Value</td> </tr> <tr> <td>pattern</td> <td>[1-9]{1}[0-9]*</td> </tr> </table>	Kind	Value	pattern	[1-9]{1}[0-9]*
Kind	Value				
pattern	[1-9]{1}[0-9]*				

element **Addizionali\_Type/AddRegDovuta**

diagram					
namespace	urn:www.agenziaentrate.gov.it:specificheTecniche:sco:730				
type	<a href="#">DatoNP_Type</a>				
facets	<table border="1"> <tr> <td>Kind</td> <td>Value</td> </tr> <tr> <td>pattern</td> <td>[1-9]{1}[0-9]*</td> </tr> </table>	Kind	Value	pattern	[1-9]{1}[0-9]*
Kind	Value				
pattern	[1-9]{1}[0-9]*				

element **Addizionali\_Type/AddRegCertif**

diagram	
---------	--

namespace	urn:www.agenziaentrate.gov.it:specificheTecniche:sco:730
type	<a href="#">DatoNP_Type</a>
facets	Kind Value pattern [1-9]{1}[0-9]*

#### element **Addizionali\_Type/EccedenzaAddReg**

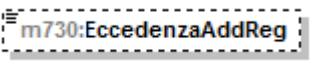
diagram	
namespace	urn:www.agenziaentrate.gov.it:specificheTecniche:sco:730
type	<a href="#">DatoNU_Type</a>
facets	Kind Value pattern (\-[1-9] [1-9])[0-9]*

#### element **Addizionali\_Type/AddComDovuta**

diagram	
namespace	urn:www.agenziaentrate.gov.it:specificheTecniche:sco:730
type	<a href="#">DatoNP_Type</a>
facets	Kind Value pattern [1-9]{1}[0-9]*

#### element **Addizionali\_Type/AddComCertif**

diagram	
namespace	urn:www.agenziaentrate.gov.it:specificheTecniche:sco:730
type	<a href="#">DatoNP_Type</a>
facets	Kind Value pattern [1-9]{1}[0-9]*

#### element **Addizionali\_Type/EccedenzaAddCom**

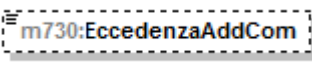
diagram	
namespace	urn:www.agenziaentrate.gov.it:specificheTecniche:sco:730
type	<a href="#">DatoNU_Type</a>
facets	Kind Value pattern (\-[1-9] [1-9])[0-9]*

element **Additionali\_Type/AccontoAddCom**

diagram	
namespace	urn:www.agenziaentrate.gov.it:specificheTecniche:sco:730
type	<a href="#">DatoNP_Type</a>
facets	Kind Value pattern [1-9]{1}[0-9]*

element **Additionali\_Type/AccontoAddComCertif**

diagram	
namespace	urn:www.agenziaentrate.gov.it:specificheTecniche:sco:730
type	<a href="#">DatoNP_Type</a>
facets	Kind Value pattern [1-9]{1}[0-9]*

complexType **Altre\_Detrazioni\_Type**

diagram	
namespace	urn:www.agenziaentrate.gov.it:specificheTecniche:sco:730
children	<a href="#">m730:Codice</a> <a href="#">m730:Importo</a>

element **Altre\_Detrazioni\_Type/Codice**

diagram	
namespace	urn:www.agenziaentrate.gov.it:specificheTecniche:sco:730
type	<a href="#">m730:Codice</a> <a href="#">Altre_Detrazioni_Type</a>
facets	Kind Value pattern [1-9]{1}[0-9]* enumeration 1 enumeration 2

element **Altre\_Detrazioni\_Type/Importo**

diagram	
namespace	urn:www.agenziaentrate.gov.it:specificheTecniche:sco:730
type	<a href="#">DatoNP_Type</a>
facets	Kind Value

pattern	[1-9]{1}[0-9]*
---------	----------------

**complexType Altre\_Ritenute\_Type**

diagram	
namespace	urn:www.agenziaentrate.gov.it:specificheTecniche:sco:730
children	<a href="#">m730:Codice</a> <a href="#">m730:AltreRitenuteIrpef</a> <a href="#">m730:AddizionaleRegionale</a> <a href="#">m730:AddizionaleComunale</a> <a href="#">m730:AddRegionaleIrpefAttivitaSport</a> <a href="#">m730:AddComunaleIrpefAttivitaSport</a> <a href="#">m730:IrpefLavoriSocialmenteUtili</a> <a href="#">m730:AddRegionaleIrpefLavoriSoc Utili</a>

**element Altre\_Ritenute\_Type/Codice**

diagram									
namespace	urn:www.agenziaentrate.gov.it:specificheTecniche:sco:730								
type	restriction of <a href="#">DatoN1_Type</a>								
facets	<table border="1"> <thead> <tr> <th>Kind</th> <th>Value</th> </tr> </thead> <tbody> <tr> <td>pattern</td> <td>[1-9]</td> </tr> <tr> <td>enumeration</td> <td>1</td> </tr> <tr> <td>enumeration</td> <td>2</td> </tr> </tbody> </table>	Kind	Value	pattern	[1-9]	enumeration	1	enumeration	2
Kind	Value								
pattern	[1-9]								
enumeration	1								
enumeration	2								

**element Altre\_Ritenute\_Type/AltreRitenuteIrpef**

diagram					
namespace	urn:www.agenziaentrate.gov.it:specificheTecniche:sco:730				
type	<a href="#">DatoNP_Type</a>				
facets	<table border="1"> <thead> <tr> <th>Kind</th> <th>Value</th> </tr> </thead> <tbody> <tr> <td>pattern</td> <td>[1-9]{1}[0-9]*</td> </tr> </tbody> </table>	Kind	Value	pattern	[1-9]{1}[0-9]*
Kind	Value				
pattern	[1-9]{1}[0-9]*				

element **Altre\_Ritenute\_Type/AddizionaleRegionale**

diagram	 m730:AddizionaleRegionale
namespace	urn:www.agenziaentrate.gov.it:specificheTecniche:sco:730
type	<a href="#">DatoNP_Type</a>
facets	Kind Value pattern [1-9]{1}[0-9]*

element **Altre\_Ritenute\_Type/AddizionaleComunale**

diagram	 m730:AddizionaleComunale
namespace	urn:www.agenziaentrate.gov.it:specificheTecniche:sco:730
type	<a href="#">DatoNP_Type</a>
facets	Kind Value pattern [1-9]{1}[0-9]*

element **Altre\_Ritenute\_Type/AddRegionalelrpefAttivitaSport**

diagram	 m730:AddRegionalelrpefAttivita...
namespace	urn:www.agenziaentrate.gov.it:specificheTecniche:sco:730
type	<a href="#">DatoNP_Type</a>
facets	Kind Value pattern [1-9]{1}[0-9]*

element **Altre\_Ritenute\_Type/AddComunalelrpefAttivitaSport**

diagram	 m730:AddComunalelrpefAttivita...
namespace	urn:www.agenziaentrate.gov.it:specificheTecniche:sco:730
type	<a href="#">DatoNP_Type</a>
facets	Kind Value pattern [1-9]{1}[0-9]*

element **Altre\_Ritenute\_Type/IrpefLavoriSocialmenteUtili**

diagram	 m730:IrpefLavoriSocialmenteUtili
namespace	urn:www.agenziaentrate.gov.it:specificheTecniche:sco:730
type	<a href="#">DatoNP_Type</a>
facets	Kind Value pattern [1-9]{1}[0-9]*

element **Altre\_Ritenute\_Type/AddRegionalelrpefLavoriSoc\_Utili**

diagram					
namespace	urn:www.agenziaentrate.gov.it:specificheTecniche:sco:730				
type	<a href="#">DatoNP_Type</a>				
facets	<table border="1"> <thead> <tr> <th>Kind</th> <th>Value</th> </tr> </thead> <tbody> <tr> <td>pattern</td> <td>[1-9]{1}[0-9]*</td> </tr> </tbody> </table>	Kind	Value	pattern	[1-9]{1}[0-9]*
Kind	Value				
pattern	[1-9]{1}[0-9]*				

complexType **Altre\_Spese\_Type**

diagram	
namespace	urn:www.agenziaentrate.gov.it:specificheTecniche:sco:730
children	<a href="#">m730:Codice</a> <a href="#">m730:Importo</a>

element **Altre\_Spese\_Type/Codice**

diagram																																																													
namespace	urn:www.agenziaentrate.gov.it:specificheTecniche:sco:730																																																												
type	restriction of <a href="#">m730:Codice Altre_Spese_Type</a>																																																												
facets	<table border="1"> <thead> <tr> <th>Kind</th> <th>Value</th> </tr> </thead> <tbody> <tr> <td>pattern</td> <td>[1-9]{1}[0-9]*</td> </tr> <tr><td>enumeration</td><td>8</td></tr> <tr><td>enumeration</td><td>9</td></tr> <tr><td>enumeration</td><td>10</td></tr> <tr><td>enumeration</td><td>11</td></tr> <tr><td>enumeration</td><td>12</td></tr> <tr><td>enumeration</td><td>13</td></tr> <tr><td>enumeration</td><td>14</td></tr> <tr><td>enumeration</td><td>15</td></tr> <tr><td>enumeration</td><td>16</td></tr> <tr><td>enumeration</td><td>17</td></tr> <tr><td>enumeration</td><td>18</td></tr> <tr><td>enumeration</td><td>20</td></tr> <tr><td>enumeration</td><td>21</td></tr> <tr><td>enumeration</td><td>22</td></tr> <tr><td>enumeration</td><td>23</td></tr> <tr><td>enumeration</td><td>24</td></tr> <tr><td>enumeration</td><td>25</td></tr> <tr><td>enumeration</td><td>26</td></tr> <tr><td>enumeration</td><td>27</td></tr> <tr><td>enumeration</td><td>28</td></tr> <tr><td>enumeration</td><td>29</td></tr> <tr><td>enumeration</td><td>30</td></tr> <tr><td>enumeration</td><td>31</td></tr> <tr><td>enumeration</td><td>32</td></tr> <tr><td>enumeration</td><td>33</td></tr> <tr><td>enumeration</td><td>35</td></tr> <tr><td>enumeration</td><td>36</td></tr> <tr><td>enumeration</td><td>38</td></tr> </tbody> </table>	Kind	Value	pattern	[1-9]{1}[0-9]*	enumeration	8	enumeration	9	enumeration	10	enumeration	11	enumeration	12	enumeration	13	enumeration	14	enumeration	15	enumeration	16	enumeration	17	enumeration	18	enumeration	20	enumeration	21	enumeration	22	enumeration	23	enumeration	24	enumeration	25	enumeration	26	enumeration	27	enumeration	28	enumeration	29	enumeration	30	enumeration	31	enumeration	32	enumeration	33	enumeration	35	enumeration	36	enumeration	38
Kind	Value																																																												
pattern	[1-9]{1}[0-9]*																																																												
enumeration	8																																																												
enumeration	9																																																												
enumeration	10																																																												
enumeration	11																																																												
enumeration	12																																																												
enumeration	13																																																												
enumeration	14																																																												
enumeration	15																																																												
enumeration	16																																																												
enumeration	17																																																												
enumeration	18																																																												
enumeration	20																																																												
enumeration	21																																																												
enumeration	22																																																												
enumeration	23																																																												
enumeration	24																																																												
enumeration	25																																																												
enumeration	26																																																												
enumeration	27																																																												
enumeration	28																																																												
enumeration	29																																																												
enumeration	30																																																												
enumeration	31																																																												
enumeration	32																																																												
enumeration	33																																																												
enumeration	35																																																												
enumeration	36																																																												
enumeration	38																																																												



	enumeration 39
	enumeration 41
	enumeration 42
	enumeration 99

element **Altre\_Spese\_Type/Importo**

diagram					
namespace	urn:www.agenziaentrate.gov.it:specificheTecniche:sco:730				
type	<a href="#">DatoNP_Type</a>				
facets	<table border="1"> <thead> <tr> <th>Kind</th> <th>Value</th> </tr> </thead> <tbody> <tr> <td>pattern</td> <td>[1-9]{1}[0-9]*</td> </tr> </tbody> </table>	Kind	Value	pattern	[1-9]{1}[0-9]*
Kind	Value				
pattern	[1-9]{1}[0-9]*				

complexType Altri\_Dati\_Type

<p>diagram</p>	
<p>namespace</p>	<p>urn:www.agenziaentrate.gov.it:specificheTecniche:sco:730</p>
<p>children</p>	<p><a href="#">m730:ResiduoCreditoErogazioneCultura</a> <a href="#">m730:ResiduoCreditoPrimaCasa</a> <a href="#">m730:ResiduoCreditoOccupazione</a> <a href="#">m730:ResiduoCreditoSisma</a> <a href="#">m730:ResiduoCreditoFondiPensione</a> <a href="#">m730:ResiduoCreditoMediazioni</a> <a href="#">m730:TotSpeseSanitarieRateizzate</a> <a href="#">m730:RedditoAgevolazioniFiscali</a> <a href="#">m730:RedditoComplessivoAcconto</a> <a href="#">m730:RigoDifferenzaAcconto</a> <a href="#">m730:AccontiCompensatiIntern</a> <a href="#">m730:RedditiFondariNonImponibili</a> <a href="#">m730:RedditoAbitazionePrincipalePertinenze</a> <a href="#">m730:ResiduoDeduzioneSommeRestituite</a> <a href="#">m730:ResiduoErogazioniScuola</a> <a href="#">m730:ResiduoCreditoNegoziazione</a> <a href="#">m730:ResiduoCreditoVideosorveglianza</a> <a href="#">m730:CreditoErogazioneCultura</a></p>

element Altri\_Dati\_Type/ResiduoCreditoErogazioneCultura

<p>diagram</p>	
----------------	--

namespace	urn:www.agenziaentrate.gov.it:specificheTecniche:sco:730
type	<a href="#">DatoNP_Type</a>
facets	Kind Value pattern [1-9]{1}[0-9]*

#### element Altri\_Dati\_Type/ResiduoCreditoPrimaCasa

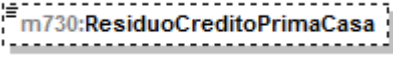
diagram	
namespace	urn:www.agenziaentrate.gov.it:specificheTecniche:sco:730
type	<a href="#">DatoNP_Type</a>
facets	Kind Value pattern [1-9]{1}[0-9]*

#### element Altri\_Dati\_Type/ResiduoCreditoOccupazione

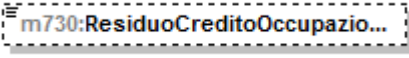
diagram	
namespace	urn:www.agenziaentrate.gov.it:specificheTecniche:sco:730
type	<a href="#">DatoNP_Type</a>
facets	Kind Value pattern [1-9]{1}[0-9]*

#### element Altri\_Dati\_Type/ResiduoCreditoSisma

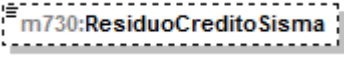
diagram	
namespace	urn:www.agenziaentrate.gov.it:specificheTecniche:sco:730
type	<a href="#">DatoNP_Type</a>
facets	Kind Value pattern [1-9]{1}[0-9]*

#### element Altri\_Dati\_Type/ResiduoCreditoFondiPensione

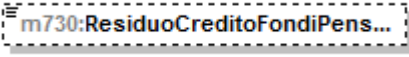
diagram	
namespace	urn:www.agenziaentrate.gov.it:specificheTecniche:sco:730
type	<a href="#">DatoNP_Type</a>
facets	Kind Value pattern [1-9]{1}[0-9]*

element **Altri\_Dati\_Type/ResiduoCreditoMediazioni**

diagram	 m730:ResiduoCreditoMediazioni
namespace	urn:www.agenziaentrate.gov.it:specificheTecniche:sco:730
type	<a href="#">DatoNP_Type</a>
facets	Kind Value pattern [1-9]{1}[0-9]*

element **Altri\_Dati\_Type/TotSpeseSanitarieRateizzate**

diagram	 m730:TotSpeseSanitarieRateizza...
namespace	urn:www.agenziaentrate.gov.it:specificheTecniche:sco:730
type	<a href="#">DatoNP_Type</a>
facets	Kind Value pattern [1-9]{1}[0-9]*

element **Altri\_Dati\_Type/RedditoAgevolazioniFiscali**

diagram	 m730:RedditoAgevolazioniFiscali
namespace	urn:www.agenziaentrate.gov.it:specificheTecniche:sco:730
type	<a href="#">DatoNP_Type</a>
facets	Kind Value pattern [1-9]{1}[0-9]*

element **Altri\_Dati\_Type/RedditoComplessivoAcconto**

diagram	 m730:RedditoComplessivoAcco...
namespace	urn:www.agenziaentrate.gov.it:specificheTecniche:sco:730
type	<a href="#">DatoNP_Type</a>
facets	Kind Value pattern [1-9]{1}[0-9]*

element **Altri\_Dati\_Type/RigoDifferenzaAcconto**

diagram	 m730:RigoDifferenzaAcconto
namespace	urn:www.agenziaentrate.gov.it:specificheTecniche:sco:730
type	<a href="#">DatoNU_Type</a>
facets	Kind Value pattern (\- [1-9])[1-9][0-9]*

element Altri\_Dati\_Type/AccontiCompensatiIntern

diagram	
namespace	urn:www.agenziaentrate.gov.it:specificheTecniche:sco:730
type	<a href="#">m730:Acoonti_Compensati_Intern_Type</a>
children	<a href="#">m730:PrimaRatalrpef</a> <a href="#">m730:AddizionaleComunale</a> <a href="#">m730:PrimaRataCedolare</a>

element Altri\_Dati\_Type/RedditiFondariNonImponibili

diagram					
namespace	urn:www.agenziaentrate.gov.it:specificheTecniche:sco:730				
type	<a href="#">DatoNP_Type</a>				
facets	<table border="1"> <thead> <tr> <th>Kind</th> <th>Value</th> </tr> </thead> <tbody> <tr> <td>pattern</td> <td>[1-9]{1}[0-9]*</td> </tr> </tbody> </table>	Kind	Value	pattern	[1-9]{1}[0-9]*
Kind	Value				
pattern	[1-9]{1}[0-9]*				

element Altri\_Dati\_Type/RedditoAbitazionePrincipalePertinenze

diagram					
namespace	urn:www.agenziaentrate.gov.it:specificheTecniche:sco:730				
type	<a href="#">DatoNP_Type</a>				
facets	<table border="1"> <thead> <tr> <th>Kind</th> <th>Value</th> </tr> </thead> <tbody> <tr> <td>pattern</td> <td>[1-9]{1}[0-9]*</td> </tr> </tbody> </table>	Kind	Value	pattern	[1-9]{1}[0-9]*
Kind	Value				
pattern	[1-9]{1}[0-9]*				

element Altri\_Dati\_Type/ResiduoDeduzioneSommeRestituite

diagram					
namespace	urn:www.agenziaentrate.gov.it:specificheTecniche:sco:730				
type	<a href="#">DatoNP_Type</a>				
facets	<table border="1"> <thead> <tr> <th>Kind</th> <th>Value</th> </tr> </thead> <tbody> <tr> <td>pattern</td> <td>[1-9]{1}[0-9]*</td> </tr> </tbody> </table>	Kind	Value	pattern	[1-9]{1}[0-9]*
Kind	Value				
pattern	[1-9]{1}[0-9]*				

element Altri\_Dati\_Type/ResiduoErogazioniScuola

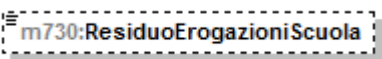
diagram	
namespace	urn:www.agenziaentrate.gov.it:specificheTecniche:sco:730
type	<a href="#">DatoNP_Type</a>
facets	Kind Value pattern [1-9]{1}[0-9]*

element Altri\_Dati\_Type/ResiduoCreditoNegoziazione

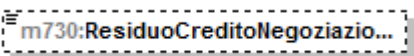
diagram	
namespace	urn:www.agenziaentrate.gov.it:specificheTecniche:sco:730
type	<a href="#">DatoNP_Type</a>
facets	Kind Value pattern [1-9]{1}[0-9]*

element Altri\_Dati\_Type/ResiduoCreditoVideosorveglianza

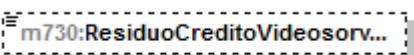
diagram	
namespace	urn:www.agenziaentrate.gov.it:specificheTecniche:sco:730
type	<a href="#">DatoNP_Type</a>
facets	Kind Value pattern [1-9]{1}[0-9]*

element Altri\_Dati\_Type/CreditoErogazioneCultura

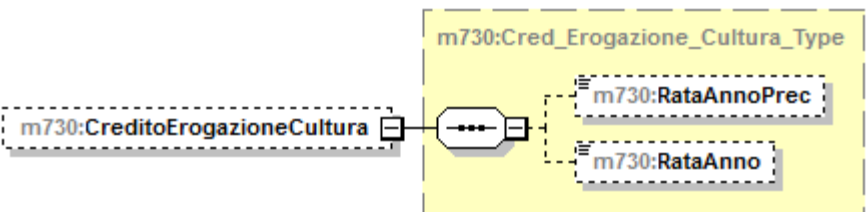
diagram	
namespace	urn:www.agenziaentrate.gov.it:specificheTecniche:sco:730
type	<a href="#">m730:Cred_Erogazione_Cultura_Type</a>
children	<a href="#">m730:RataAnnoPrec</a> <a href="#">m730:RataAnno</a>

**complexType Altri\_Oneri\_Type**

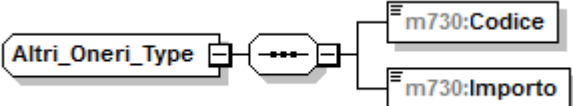
diagram	
namespace	urn:www.agenziaentrate.gov.it:specificheTecniche:sco:730
children	<a href="#">m730:Codice</a> <a href="#">m730:Importo</a>

**element Altri\_Oneri\_Type/Codice**

diagram																			
namespace	urn:www.agenziaentrate.gov.it:specificheTecniche:sco:730																		
type	<a href="#">m730:Codice Altri_Oneri_Type</a>																		
facets	<table border="1"> <thead> <tr> <th>Kind</th> <th>Value</th> </tr> </thead> <tbody> <tr> <td>pattern</td> <td>[1-9]{1}[0-9]*</td> </tr> <tr> <td>enumeration</td> <td>6</td> </tr> <tr> <td>enumeration</td> <td>7</td> </tr> <tr> <td>enumeration</td> <td>8</td> </tr> <tr> <td>enumeration</td> <td>9</td> </tr> <tr> <td>enumeration</td> <td>12</td> </tr> <tr> <td>enumeration</td> <td>13</td> </tr> <tr> <td>enumeration</td> <td>21</td> </tr> </tbody> </table>	Kind	Value	pattern	[1-9]{1}[0-9]*	enumeration	6	enumeration	7	enumeration	8	enumeration	9	enumeration	12	enumeration	13	enumeration	21
Kind	Value																		
pattern	[1-9]{1}[0-9]*																		
enumeration	6																		
enumeration	7																		
enumeration	8																		
enumeration	9																		
enumeration	12																		
enumeration	13																		
enumeration	21																		

**element Altri\_Oneri\_Type/Importo**

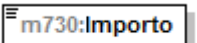
diagram					
namespace	urn:www.agenziaentrate.gov.it:specificheTecniche:sco:730				
type	<a href="#">DatoNP_Type</a>				
facets	<table border="1"> <thead> <tr> <th>Kind</th> <th>Value</th> </tr> </thead> <tbody> <tr> <td>pattern</td> <td>[1-9]{1}[0-9]*</td> </tr> </tbody> </table>	Kind	Value	pattern	[1-9]{1}[0-9]*
Kind	Value				
pattern	[1-9]{1}[0-9]*				

**complexType Altri\_Redditi\_Ass\_Lav\_Type**

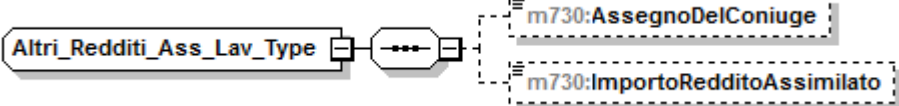
diagram	
namespace	urn:www.agenziaentrate.gov.it:specificheTecniche:sco:730
children	<a href="#">m730:AssegnoDelConiuge</a> <a href="#">m730:ImportoRedditoAssimilato</a>

**element Altri\_Redditi\_Ass\_Lav\_Type/AssegnoDelConiuge**

diagram	
---------	---

namespace	urn:www.agenziaentrate.gov.it:specificheTecniche:sco:730				
type	<a href="#">DatoCB_Type</a>				
facets	<table border="1"> <thead> <tr> <th>Kind</th> <th>Value</th> </tr> </thead> <tbody> <tr> <td>pattern</td> <td>[01]</td> </tr> </tbody> </table>	Kind	Value	pattern	[01]
Kind	Value				
pattern	[01]				

element **Altri\_Reddito\_Ass\_Lav\_Type/ImportoRedditoAssimilato**

diagram					
namespace	urn:www.agenziaentrate.gov.it:specificheTecniche:sco:730				
type	<a href="#">DatoNP_Type</a>				
facets	<table border="1"> <thead> <tr> <th>Kind</th> <th>Value</th> </tr> </thead> <tbody> <tr> <td>pattern</td> <td>[1-9]{1}[0-9]*</td> </tr> </tbody> </table>	Kind	Value	pattern	[1-9]{1}[0-9]*
Kind	Value				
pattern	[1-9]{1}[0-9]*				

complexType **Altri\_Reddito\_Diversi\_Detr\_Type**

diagram	
namespace	urn:www.agenziaentrate.gov.it:specificheTecniche:sco:730
children	<a href="#">m730:Tipo_Reddito</a> <a href="#">m730:RedditoRitenuteSpese</a>

element **Altri\_Reddito\_Diversi\_Detr\_Type/Tipo\_Reddito**

diagram													
namespace	urn:www.agenziaentrate.gov.it:specificheTecniche:sco:730												
type	<a href="#">m730:Tipo_Reddito_Da1a4_Type</a>												
facets	<table border="1"> <thead> <tr> <th>Kind</th> <th>Value</th> </tr> </thead> <tbody> <tr> <td>pattern</td> <td>[1-9]</td> </tr> <tr> <td>enumeration</td> <td>1</td> </tr> <tr> <td>enumeration</td> <td>2</td> </tr> <tr> <td>enumeration</td> <td>3</td> </tr> <tr> <td>enumeration</td> <td>4</td> </tr> </tbody> </table>	Kind	Value	pattern	[1-9]	enumeration	1	enumeration	2	enumeration	3	enumeration	4
Kind	Value												
pattern	[1-9]												
enumeration	1												
enumeration	2												
enumeration	3												
enumeration	4												



element **Altri\_Reddit\_Diversi\_Detr\_Type/RedditiRitenuteSpese**

diagram	
namespace	urn:www.agenziaentrate.gov.it:specificheTecniche:sco:730
type	<a href="#">m730:Redditi_Ritenute_Spese_Type</a>
children	<a href="#">m730:ImportoRedditi</a> <a href="#">m730:ImportoRitenute</a> <a href="#">m730:ImportoSpese</a>

complexType **Altri\_Reddit\_Diversi\_Type**

diagram	
namespace	urn:www.agenziaentrate.gov.it:specificheTecniche:sco:730
children	<a href="#">m730:CedolareSecca</a> <a href="#">m730:TipoReddito</a> <a href="#">m730:RedditiRitenuteSpese</a>

element **Altri\_Reddit\_Diversi\_Type/CedolareSecca**

diagram					
namespace	urn:www.agenziaentrate.gov.it:specificheTecniche:sco:730				
type	<a href="#">DatoCB_Type</a>				
facets	<table border="1"> <thead> <tr> <th>Kind</th> <th>Value</th> </tr> </thead> <tbody> <tr> <td>pattern</td> <td>[01]</td> </tr> </tbody> </table>	Kind	Value	pattern	[01]
Kind	Value				
pattern	[01]				

element **Altri\_Reddit\_Diversi\_Type/TipoReddito**

diagram													
namespace	urn:www.agenziaentrate.gov.it:specificheTecniche:sco:730												
type	restriction of <a href="#">DatoNP_Type</a>												
facets	<table border="1"> <thead> <tr> <th>Kind</th> <th>Value</th> </tr> </thead> <tbody> <tr> <td>pattern</td> <td>[1-9]{1}[0-9]*</td> </tr> <tr> <td>enumeration</td> <td>1</td> </tr> <tr> <td>enumeration</td> <td>2</td> </tr> <tr> <td>enumeration</td> <td>3</td> </tr> <tr> <td>enumeration</td> <td>4</td> </tr> </tbody> </table>	Kind	Value	pattern	[1-9]{1}[0-9]*	enumeration	1	enumeration	2	enumeration	3	enumeration	4
Kind	Value												
pattern	[1-9]{1}[0-9]*												
enumeration	1												
enumeration	2												
enumeration	3												
enumeration	4												

	enumeration	5
	enumeration	6
	enumeration	7
	enumeration	8
	enumeration	9
	enumeration	10

element **Altri\_Reddi\_Diversi\_Type/ReddiRitenuteSpese**

diagram	
namespace	urn:www.agenziaentrate.gov.it:specificheTecniche:sco:730
type	<a href="#">m730:Reddi_Ritenute_Spese_Type</a>
children	<a href="#">m730:ImportoReddi</a> <a href="#">m730:ImportoRitenute</a> <a href="#">m730:ImportoSpese</a>

complexType **Altri\_Reddi\_Lavoro\_Autonomo\_Type**

diagram	
namespace	urn:www.agenziaentrate.gov.it:specificheTecniche:sco:730
children	<a href="#">m730:TipoReddito</a> <a href="#">m730:ReddiRitenute</a>

element **Altri\_Reddi\_Lavoro\_Autonomo\_Type/TipoReddito**

diagram													
namespace	urn:www.agenziaentrate.gov.it:specificheTecniche:sco:730												
type	<a href="#">m730:Tipo_Reddito_Da1a4_Type</a>												
facets	<table border="1"> <thead> <tr> <th>Kind</th> <th>Value</th> </tr> </thead> <tbody> <tr> <td>pattern</td> <td>[1-9]</td> </tr> <tr> <td>enumeration</td> <td>1</td> </tr> <tr> <td>enumeration</td> <td>2</td> </tr> <tr> <td>enumeration</td> <td>3</td> </tr> <tr> <td>enumeration</td> <td>4</td> </tr> </tbody> </table>	Kind	Value	pattern	[1-9]	enumeration	1	enumeration	2	enumeration	3	enumeration	4
Kind	Value												
pattern	[1-9]												
enumeration	1												
enumeration	2												
enumeration	3												
enumeration	4												

element **Altri\_Reddi\_Lavoro\_Autonomo\_Type/ReddiRitenute**

diagram	<p>The diagram shows a dashed box labeled 'm730:ReddiRitenute' connected to a solid box labeled 'm730:Reddi_Ritenute_Type'. Inside the solid box, there are two dashed boxes: 'm730:ImportoReddi' and 'm730:ImportoRitenute'.</p>
namespace	urn:www.agenziaentrate.gov.it:specificheTecniche:sco:730
type	<a href="#">m730:Reddi_Ritenute_Type</a>
children	<a href="#">m730:ImportoReddi</a> <a href="#">m730:ImportoRitenute</a>

complexType **Altri\_Reddi\_Type**

diagram	<p>The diagram shows a solid box labeled 'Altri_Reddi_Type' with the text 'Quadro D - Altri Reddi' below it. It is connected to a solid box labeled 'm730:Modulo' with '1..∞' below it.</p>
namespace	urn:www.agenziaentrate.gov.it:specificheTecniche:sco:730
children	<a href="#">m730:Modulo</a>

element **Altri\_Reddi\_Type/Modulo**

diagram	<p>The diagram shows a solid box labeled 'm730:Modulo' with '1..∞' below it. It is connected to a dashed box labeled 'm730:Modulo_Altri_Reddi_Type'. Inside the dashed box, there are two solid boxes: 'm730:ReddiDiCapitale' and 'm730:ReddiTassazioneSeparata', both with a '+' sign in the top right corner.</p>
namespace	urn:www.agenziaentrate.gov.it:specificheTecniche:sco:730
type	<a href="#">m730:Modulo Altri_Reddi_Type</a>
children	<a href="#">m730:ReddiDiCapitale</a> <a href="#">m730:ReddiTassazioneSeparata</a>

complexType **Altri\_Reddi\_Utili\_Type**

diagram	<p>The diagram shows a solid box labeled 'Altri_Reddi_Utili_Type' connected to a solid box labeled 'm730:Tipo_Reddito' and a dashed box labeled 'm730:ReddiRitenute' with a '+' sign in the top right corner.</p>
namespace	urn:www.agenziaentrate.gov.it:specificheTecniche:sco:730
children	<a href="#">m730:Tipo_Reddito</a> <a href="#">m730:ReddiRitenute</a>

element **Altri\_Reddito\_Utili\_Type/Tipo\_Reddito**

diagram																											
namespace	urn:www.agenziaentrate.gov.it:specificheTecniche:sco:730																										
type	restriction of <a href="#">DatoNP_Type</a>																										
facets	<table border="1"> <thead> <tr> <th>Kind</th> <th>Value</th> </tr> </thead> <tbody> <tr> <td>pattern</td> <td>[1-9]{1}[0-9]*</td> </tr> <tr> <td>enumeration</td> <td>1</td> </tr> <tr> <td>enumeration</td> <td>2</td> </tr> <tr> <td>enumeration</td> <td>3</td> </tr> <tr> <td>enumeration</td> <td>4</td> </tr> <tr> <td>enumeration</td> <td>5</td> </tr> <tr> <td>enumeration</td> <td>6</td> </tr> <tr> <td>enumeration</td> <td>7</td> </tr> <tr> <td>enumeration</td> <td>8</td> </tr> <tr> <td>enumeration</td> <td>9</td> </tr> <tr> <td>enumeration</td> <td>10</td> </tr> <tr> <td>enumeration</td> <td>11</td> </tr> </tbody> </table>	Kind	Value	pattern	[1-9]{1}[0-9]*	enumeration	1	enumeration	2	enumeration	3	enumeration	4	enumeration	5	enumeration	6	enumeration	7	enumeration	8	enumeration	9	enumeration	10	enumeration	11
Kind	Value																										
pattern	[1-9]{1}[0-9]*																										
enumeration	1																										
enumeration	2																										
enumeration	3																										
enumeration	4																										
enumeration	5																										
enumeration	6																										
enumeration	7																										
enumeration	8																										
enumeration	9																										
enumeration	10																										
enumeration	11																										

element **Altri\_Reddito\_Utili\_Type/RedditiRitenute**

diagram	
namespace	urn:www.agenziaentrate.gov.it:specificheTecniche:sco:730
type	<a href="#">m730:Redditi_Ritenute_Type</a>
children	<a href="#">m730:ImportoRedditi</a> <a href="#">m730:ImportoRitenute</a>

complexType **Annotazione\_Type**

diagram	
namespace	urn:www.agenziaentrate.gov.it:specificheTecniche:sco:730
children	<a href="#">m730:Codice</a> <a href="#">m730:RigoQuadro</a> <a href="#">m730:ModuloQuadro</a> <a href="#">m730:Importo</a>

element **Annotazione\_Type/Codice**

diagram	
namespace	urn:www.agenziaentrate.gov.it:specificheTecniche:sco:730
type	<a href="#">DatoAN_Type</a>
facets	Kind Value pattern (([0-9A-Z\-\] \&quot;){1}([ 0-9A-Z&amp;:] \-\ \., / \^\ \(\ \)\ À É È Ì Ò Ù Ü &quot; \ \\ \ +)*

element **Annotazione\_Type/RigoQuadro**

diagram	
namespace	urn:www.agenziaentrate.gov.it:specificheTecniche:sco:730
type	<a href="#">DatoNP_Type</a>
facets	Kind Value pattern [1-9]{1}[0-9]*

element **Annotazione\_Type/ModuloQuadro**

diagram	
namespace	urn:www.agenziaentrate.gov.it:specificheTecniche:sco:730
type	<a href="#">DatoNP_Type</a>
facets	Kind Value pattern [1-9]{1}[0-9]*

element **Annotazione\_Type/Importo**

diagram	
namespace	urn:www.agenziaentrate.gov.it:specificheTecniche:sco:730
type	<a href="#">DatoNP_Type</a>
facets	Kind Value pattern [1-9]{1}[0-9]*

complexType **Assegno\_Coniuge\_Type**

diagram	
namespace	urn:www.agenziaentrate.gov.it:specificheTecniche:sco:730
children	<a href="#">m730:CodiceFiscale</a> <a href="#">m730:Importo</a>

element **Assegno\_Coniuge\_Type/CodiceFiscale**

diagram					
namespace	urn:www.agenziaentrate.gov.it:specificheTecniche:sco:730				
type	<a href="#">DatoCF_Type</a>				
facets	<table border="1"> <thead> <tr> <th>Kind</th> <th>Value</th> </tr> </thead> <tbody> <tr> <td>pattern</td> <td>[0-9]{1}[A-Z]{6}[0-9LMNPQRSTU]{2}[A-Z]{1}[0-9LMNPQRSTU]{2}[A-Z]{1}[0-9LMNPQRSTU]{3}[A-Z]{1}</td> </tr> </tbody> </table>	Kind	Value	pattern	[0-9]{1}[A-Z]{6}[0-9LMNPQRSTU]{2}[A-Z]{1}[0-9LMNPQRSTU]{2}[A-Z]{1}[0-9LMNPQRSTU]{3}[A-Z]{1}
Kind	Value				
pattern	[0-9]{1}[A-Z]{6}[0-9LMNPQRSTU]{2}[A-Z]{1}[0-9LMNPQRSTU]{2}[A-Z]{1}[0-9LMNPQRSTU]{3}[A-Z]{1}				

element **Assegno\_Coniuge\_Type/Importo**

diagram					
namespace	urn:www.agenziaentrate.gov.it:specificheTecniche:sco:730				
type	<a href="#">DatoNP_Type</a>				
facets	<table border="1"> <thead> <tr> <th>Kind</th> <th>Value</th> </tr> </thead> <tbody> <tr> <td>pattern</td> <td>[1-9]{1}[0-9]*</td> </tr> </tbody> </table>	Kind	Value	pattern	[1-9]{1}[0-9]*
Kind	Value				
pattern	[1-9]{1}[0-9]*				

complexType **Bonus\_Irpef\_Type**

diagram	
namespace	urn:www.agenziaentrate.gov.it:specificheTecniche:sco:730
children	<a href="#">m730:CodiceBonus</a> <a href="#">m730:BonusErogato</a> <a href="#">m730:Esenzione</a> <a href="#">m730:QuotaTfr</a>

element **Bonus\_Irpef\_Type/CodiceBonus**

diagram									
namespace	urn:www.agenziaentrate.gov.it:specificheTecniche:sco:730								
type	restriction of <a href="#">DatoN1_Type</a>								
facets	<table border="1"> <thead> <tr> <th>Kind</th> <th>Value</th> </tr> </thead> <tbody> <tr> <td>pattern</td> <td>[1-9]</td> </tr> <tr> <td>enumeration</td> <td>1</td> </tr> <tr> <td>enumeration</td> <td>2</td> </tr> </tbody> </table>	Kind	Value	pattern	[1-9]	enumeration	1	enumeration	2
Kind	Value								
pattern	[1-9]								
enumeration	1								
enumeration	2								

element **Bonus\_Irpef\_Type/BonusErogato**

diagram	
namespace	urn:www.agenziaentrate.gov.it:specificheTecniche:sco:730
type	<a href="#">DatoNP_Type</a>
facets	Kind Value pattern [1-9]{1}[0-9]*

element **Bonus\_Irpef\_Type/Esenzione**

diagram	
namespace	urn:www.agenziaentrate.gov.it:specificheTecniche:sco:730
type	<a href="#">m730:Esenzione Bonus_Type</a>
children	<a href="#">m730:TipologiaEsenzione</a> <a href="#">m730:ParteRedditoEsente</a>

element **Bonus\_Irpef\_Type/QuotaTfr**

diagram	
namespace	urn:www.agenziaentrate.gov.it:specificheTecniche:sco:730
type	<a href="#">DatoNP_Type</a>
facets	Kind Value pattern [1-9]{1}[0-9]*

complexType **Casella\_Acconto\_Type**

diagram	
namespace	urn:www.agenziaentrate.gov.it:specificheTecniche:sco:730
children	<a href="#">m730:Casella</a> <a href="#">m730:ImportoMisuraInferiore</a>

element **Casella\_Acconto\_Type/Casella**

diagram	
---------	--

namespace	urn:www.agenziaentrate.gov.it:specificheTecniche:sco:730
type	<a href="#">DatoCB_Type</a>
facets	Kind Value pattern [01]

element **Casella\_Aconto\_Type/ImportoMisuralInferiore**

diagram	
namespace	urn:www.agenziaentrate.gov.it:specificheTecniche:sco:730
type	<a href="#">DatoNP_Type</a>
facets	Kind Value pattern [1-9]{1}[0-9]*

complexType **Cedolare\_Secca\_Type**

diagram	
namespace	urn:www.agenziaentrate.gov.it:specificheTecniche:sco:730
children	<a href="#">m730:CedolareDovuta</a> <a href="#">m730:CedolareDifferenza</a> <a href="#">m730:EccedenzaCedolareSecca</a> <a href="#">m730:AccontoCedolare</a>

element **Cedolare\_Secca\_Type/CedolareDovuta**

diagram	
namespace	urn:www.agenziaentrate.gov.it:specificheTecniche:sco:730
type	<a href="#">DatoNP_Type</a>
facets	Kind Value pattern [1-9]{1}[0-9]*

element **Cedolare\_Secca\_Type/CedolareDifferenza**

diagram	
namespace	urn:www.agenziaentrate.gov.it:specificheTecniche:sco:730
type	<a href="#">DatoNP_Type</a>
facets	Kind Value pattern [1-9]{1}[0-9]*

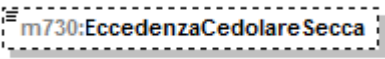

element **Cedolare\_Secca\_Type/EccedenzaCedolareSecca**

diagram	
namespace	urn:www.agenziaentrate.gov.it:specificheTecniche:sco:730
type	<a href="#">DatoNU_Type</a>
facets	Kind Value pattern $(\backslash-[1-9][1-9])[0-9]^*$

element **Cedolare\_Secca\_Type/AccontoCedolare**

diagram	
namespace	urn:www.agenziaentrate.gov.it:specificheTecniche:sco:730
type	<a href="#">DatoNP_Type</a>
facets	Kind Value pattern $[1-9]\{1\}[0-9]^*$

complexType **Comunicazione\_Amministratore\_Type**

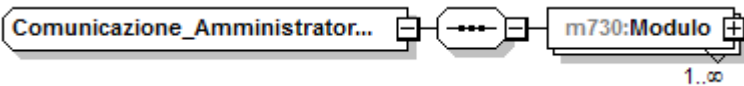
diagram	
namespace	urn:www.agenziaentrate.gov.it:specificheTecniche:sco:730
children	<a href="#">m730:Modulo</a>

element **Comunicazione\_Amministratore\_Type/Modulo**

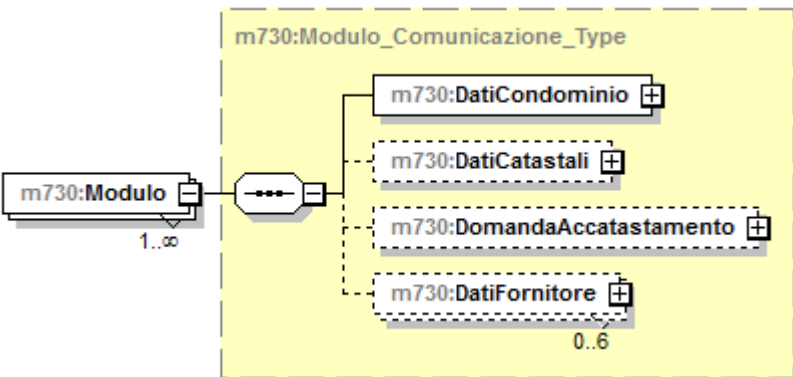
diagram	
namespace	urn:www.agenziaentrate.gov.it:specificheTecniche:sco:730
type	<a href="#">m730:Modulo_Comunicazione_Type</a>
children	<a href="#">m730:DatiCondominio</a> <a href="#">m730:DatiCatastali</a> <a href="#">m730:DomandaAccatastamento</a> <a href="#">m730:DatiFornitore</a>

complexType **Conguaglio\_Type**

diagram	
namespace	urn:www.agenziaentrate.gov.it:specificheTecniche:sco:730
children	<a href="#">m730:NumeroRate</a> <a href="#">m730:ImportoTrattenutoSaldo</a> <a href="#">m730:ImportoTrattenutoAcconto</a> <a href="#">m730:ImportoDaVersareF24Saldo</a> <a href="#">m730:ImportoDaVersareF24Acc...</a> <a href="#">m730:ImportoRimborsato</a> <a href="#">m730:ImportoRimborsatoAgenzia</a> <a href="#">m730:OpzioneInformativa</a>

element **Conguaglio\_Type/NumeroRate**

diagram																	
namespace	urn:www.agenziaentrate.gov.it:specificheTecniche:sco:730																
type	restriction of <a href="#">DatoN1_Type</a>																
facets	<table border="1"> <thead> <tr> <th>Kind</th> <th>Value</th> </tr> </thead> <tbody> <tr> <td>pattern</td> <td>[1-9]</td> </tr> <tr> <td>enumeration</td> <td>2</td> </tr> <tr> <td>enumeration</td> <td>3</td> </tr> <tr> <td>enumeration</td> <td>4</td> </tr> <tr> <td>enumeration</td> <td>5</td> </tr> <tr> <td>enumeration</td> <td>6</td> </tr> <tr> <td>enumeration</td> <td>7</td> </tr> </tbody> </table>	Kind	Value	pattern	[1-9]	enumeration	2	enumeration	3	enumeration	4	enumeration	5	enumeration	6	enumeration	7
Kind	Value																
pattern	[1-9]																
enumeration	2																
enumeration	3																
enumeration	4																
enumeration	5																
enumeration	6																
enumeration	7																

element **Conguaglio\_Type/ImportoTrattenutoSaldo**

diagram					
namespace	urn:www.agenziaentrate.gov.it:specificheTecniche:sco:730				
type	<a href="#">DatoNP_Type</a>				
facets	<table border="1"> <thead> <tr> <th>Kind</th> <th>Value</th> </tr> </thead> <tbody> <tr> <td>pattern</td> <td>[1-9]{1}[0-9]*</td> </tr> </tbody> </table>	Kind	Value	pattern	[1-9]{1}[0-9]*
Kind	Value				
pattern	[1-9]{1}[0-9]*				

**element Conguaglio\_Type/ImportoTrattenutoAcconto**

diagram	 m730:ImportoTrattenutoAcconto				
namespace	urn:www.agenziaentrate.gov.it:specificheTecniche:sco:730				
type	<a href="#">DatoNP_Type</a>				
facets	<table border="1"> <tr> <td>Kind</td> <td>Value</td> </tr> <tr> <td>pattern</td> <td>[1-9]{1}[0-9]*</td> </tr> </table>	Kind	Value	pattern	[1-9]{1}[0-9]*
Kind	Value				
pattern	[1-9]{1}[0-9]*				

**element Conguaglio\_Type/ImportoDaVersareF24Saldo**

diagram	 m730:ImportoDaVersareF24Saldo				
namespace	urn:www.agenziaentrate.gov.it:specificheTecniche:sco:730				
type	<a href="#">DatoNP_Type</a>				
facets	<table border="1"> <tr> <td>Kind</td> <td>Value</td> </tr> <tr> <td>pattern</td> <td>[1-9]{1}[0-9]*</td> </tr> </table>	Kind	Value	pattern	[1-9]{1}[0-9]*
Kind	Value				
pattern	[1-9]{1}[0-9]*				

**element Conguaglio\_Type/ImportoDaVersareF24Acconto**

diagram	 m730:ImportoDaVersareF24Acc...				
namespace	urn:www.agenziaentrate.gov.it:specificheTecniche:sco:730				
type	<a href="#">DatoNP_Type</a>				
facets	<table border="1"> <tr> <td>Kind</td> <td>Value</td> </tr> <tr> <td>pattern</td> <td>[1-9]{1}[0-9]*</td> </tr> </table>	Kind	Value	pattern	[1-9]{1}[0-9]*
Kind	Value				
pattern	[1-9]{1}[0-9]*				

**element Conguaglio\_Type/ImportoRimborsato**

diagram	 m730:ImportoRimborsato				
namespace	urn:www.agenziaentrate.gov.it:specificheTecniche:sco:730				
type	<a href="#">DatoNP_Type</a>				
facets	<table border="1"> <tr> <td>Kind</td> <td>Value</td> </tr> <tr> <td>pattern</td> <td>[1-9]{1}[0-9]*</td> </tr> </table>	Kind	Value	pattern	[1-9]{1}[0-9]*
Kind	Value				
pattern	[1-9]{1}[0-9]*				

**element Conguaglio\_Type/ImportoRimborsatoAgenzia**

diagram	 m730:ImportoRimborsatoAgenzia				
namespace	urn:www.agenziaentrate.gov.it:specificheTecniche:sco:730				
type	<a href="#">DatoNP_Type</a>				
facets	<table border="1"> <tr> <td>Kind</td> <td>Value</td> </tr> <tr> <td>pattern</td> <td>[1-9]{1}[0-9]*</td> </tr> </table>	Kind	Value	pattern	[1-9]{1}[0-9]*
Kind	Value				
pattern	[1-9]{1}[0-9]*				

**element Conguaglio\_Type/OpzioneInformativa**

diagram	
namespace	urn:www.agenziaentrate.gov.it:specificheTecniche:sco:730
type	<a href="#">DatoCB_Type</a>
facets	Kind Value pattern [01]

**complexType Contributi\_Previdenza\_Complementare\_Type**

diagram	
namespace	urn:www.agenziaentrate.gov.it:specificheTecniche:sco:730
children	<a href="#">m730:EsclusiDalSostituto</a> <a href="#">m730:NonEsclusiDalSostituto</a>

**element Contributi\_Previdenza\_Complementare\_Type/EsclusiDalSostituto**

diagram	
namespace	urn:www.agenziaentrate.gov.it:specificheTecniche:sco:730
type	<a href="#">DatoNP_Type</a>
facets	Kind Value pattern [1-9]{1}[0-9]*

**element Contributi\_Previdenza\_Complementare\_Type/NonEsclusiDalSostituto**

diagram	
namespace	urn:www.agenziaentrate.gov.it:specificheTecniche:sco:730
type	<a href="#">DatoNP_Type</a>
facets	Kind Value pattern [1-9]{1}[0-9]*

complexType **Contributo\_Solidarieta\_Type**

diagram	
namespace	urn:www.agenziaentrate.gov.it:specificheTecniche:sco:730
children	<a href="#">m730:ImponibileContributo</a> <a href="#">m730:ContributoDovuto</a> <a href="#">m730:ContributoCertificaz</a>

element **Contributo\_Solidarieta\_Type/ImponibileContributo**

diagram					
namespace	urn:www.agenziaentrate.gov.it:specificheTecniche:sco:730				
type	<a href="#">DatoNP_Type</a>				
facets	<table border="1"> <tr> <td>Kind</td> <td>Value</td> </tr> <tr> <td>pattern</td> <td>[1-9]{1}[0-9]*</td> </tr> </table>	Kind	Value	pattern	[1-9]{1}[0-9]*
Kind	Value				
pattern	[1-9]{1}[0-9]*				

element **Contributo\_Solidarieta\_Type/ContributoDovuto**

diagram					
namespace	urn:www.agenziaentrate.gov.it:specificheTecniche:sco:730				
type	<a href="#">DatoNP_Type</a>				
facets	<table border="1"> <tr> <td>Kind</td> <td>Value</td> </tr> <tr> <td>pattern</td> <td>[1-9]{1}[0-9]*</td> </tr> </table>	Kind	Value	pattern	[1-9]{1}[0-9]*
Kind	Value				
pattern	[1-9]{1}[0-9]*				

element **Contributo\_Solidarieta\_Type/ContributoCertificaz**

diagram					
namespace	urn:www.agenziaentrate.gov.it:specificheTecniche:sco:730				
type	<a href="#">DatoNP_Type</a>				
facets	<table border="1"> <tr> <td>Kind</td> <td>Value</td> </tr> <tr> <td>pattern</td> <td>[1-9]{1}[0-9]*</td> </tr> </table>	Kind	Value	pattern	[1-9]{1}[0-9]*
Kind	Value				
pattern	[1-9]{1}[0-9]*				

complexType **Cred\_Erogazione\_Cultura\_Type**

diagram	
namespace	urn:www.agenziaentrate.gov.it:specificheTecniche:sco:730

children	<a href="#">m730:RataAnnoPrec</a> <a href="#">m730:RataAnno</a>
----------	---

**element Cred\_Erogazione\_Cultura\_Type/RataAnnoPrec**

diagram	
namespace	urn:www.agenziaentrate.gov.it:specificheTecniche:sco:730
type	<a href="#">DatoNP_Type</a>
facets	Kind Value pattern [1-9]{1}[0-9]*

**element Cred\_Erogazione\_Cultura\_Type/RataAnno**

diagram	
namespace	urn:www.agenziaentrate.gov.it:specificheTecniche:sco:730
type	<a href="#">DatoNP_Type</a>
facets	Kind Value pattern [1-9]{1}[0-9]*

**complexType Cred\_Imp\_Estero\_Type**

diagram	
namespace	urn:www.agenziaentrate.gov.it:specificheTecniche:sco:730
children	<a href="#">m730:Anno</a> <a href="#">m730:TotCredito</a> <a href="#">m730:CreditoStato</a>

**element Cred\_Imp\_Estero\_Type/Anno**

diagram	
namespace	urn:www.agenziaentrate.gov.it:specificheTecniche:sco:730
type	<a href="#">DatoDA_Type</a>
facets	Kind Value pattern (18 19 20)[0-9]{2}

element **Cred\_Imp\_Estero\_Type/TotCredito**

diagram					
namespace	urn:www.agenziaentrate.gov.it:specificheTecniche:sco:730				
type	<a href="#">DatoNP_Type</a>				
facets	<table border="1"> <tr> <td>Kind</td> <td>Value</td> </tr> <tr> <td>pattern</td> <td>[1-9]{1}[0-9]*</td> </tr> </table>	Kind	Value	pattern	[1-9]{1}[0-9]*
Kind	Value				
pattern	[1-9]{1}[0-9]*				

element **Cred\_Imp\_Estero\_Type/CreditoStato**

diagram	
namespace	urn:www.agenziaentrate.gov.it:specificheTecniche:sco:730
type	<a href="#">m730:Credito_Stato_Type</a>
children	<a href="#">m730:Stato</a> <a href="#">m730:Credito</a>

complexType **Crediti\_F24\_Type**

diagram	
namespace	urn:www.agenziaentrate.gov.it:specificheTecniche:sco:730
children	<a href="#">m730:Credlrpef</a> <a href="#">m730:CredlrpefDipNoSostituto</a> <a href="#">m730:CodAddReg</a> <a href="#">m730:CredAddReg</a> <a href="#">m730:CredAddRegDipNoSostituto</a> <a href="#">m730:CodiceAddCom</a> <a href="#">m730:CredAddCom</a> <a href="#">m730:CredAddComDipNoSostituto</a> <a href="#">m730:CredCedolare</a> <a href="#">m730:CredCedolareDipNoSostituto</a> <a href="#">m730:CredTassSeparDipNoSostituto</a> <a href="#">m730:CredImpostaSostDipNoSostituto</a> <a href="#">m730:Totale</a> <a href="#">m730:TotaleDipNoSostituto</a>

element **Crediti\_F24\_Type/Credlrpef**

diagram					
namespace	urn:www.agenziaentrate.gov.it:specificheTecniche:sco:730				
type	<a href="#">DatoNP_Type</a>				
facets	<table border="1"> <tr> <td>Kind</td> <td>Value</td> </tr> <tr> <td>pattern</td> <td>[1-9]{1}[0-9]*</td> </tr> </table>	Kind	Value	pattern	[1-9]{1}[0-9]*
Kind	Value				
pattern	[1-9]{1}[0-9]*				

element **Crediti\_F24\_Type/CredlrpefDipNoSostituto**

diagram	
---------	--



namespace	urn:www.agenziaentrate.gov.it:specificheTecniche:sco:730				
type	<a href="#">DatoNP_Type</a>				
facets	<table border="1"> <thead> <tr> <th>Kind</th> <th>Value</th> </tr> </thead> <tbody> <tr> <td>pattern</td> <td>[1-9]{1}[0-9]*</td> </tr> </tbody> </table>	Kind	Value	pattern	[1-9]{1}[0-9]*
Kind	Value				
pattern	[1-9]{1}[0-9]*				

#### element **Crediti\_F24\_Type/CodAddReg**

diagram																																															
namespace	urn:www.agenziaentrate.gov.it:specificheTecniche:sco:730																																														
type	<a href="#">Codice Regione_Type</a>																																														
facets	<table border="1"> <thead> <tr> <th>Kind</th> <th>Value</th> </tr> </thead> <tbody> <tr> <td>pattern</td> <td>([0-9A-Z\-\ ]&amp;quot;){1}([ 0-9A-Z&amp;amp;] '\- . \./ \° \^ \( \) \À \È \É \  \Ò \Ù \Ü &amp;quot; \  \ +)*</td> </tr> <tr><td>enumeration</td><td>1</td></tr> <tr><td>enumeration</td><td>2</td></tr> <tr><td>enumeration</td><td>3</td></tr> <tr><td>enumeration</td><td>4</td></tr> <tr><td>enumeration</td><td>5</td></tr> <tr><td>enumeration</td><td>6</td></tr> <tr><td>enumeration</td><td>7</td></tr> <tr><td>enumeration</td><td>8</td></tr> <tr><td>enumeration</td><td>9</td></tr> <tr><td>enumeration</td><td>10</td></tr> <tr><td>enumeration</td><td>11</td></tr> <tr><td>enumeration</td><td>12</td></tr> <tr><td>enumeration</td><td>13</td></tr> <tr><td>enumeration</td><td>14</td></tr> <tr><td>enumeration</td><td>15</td></tr> <tr><td>enumeration</td><td>16</td></tr> <tr><td>enumeration</td><td>17</td></tr> <tr><td>enumeration</td><td>18</td></tr> <tr><td>enumeration</td><td>19</td></tr> <tr><td>enumeration</td><td>20</td></tr> <tr><td>enumeration</td><td>21</td></tr> </tbody> </table>	Kind	Value	pattern	([0-9A-Z\-\ ]&quot;){1}([ 0-9A-Z&amp;] '\- . \./ \° \^ \( \) \À \È \É \  \Ò \Ù \Ü &quot; \  \ +)*	enumeration	1	enumeration	2	enumeration	3	enumeration	4	enumeration	5	enumeration	6	enumeration	7	enumeration	8	enumeration	9	enumeration	10	enumeration	11	enumeration	12	enumeration	13	enumeration	14	enumeration	15	enumeration	16	enumeration	17	enumeration	18	enumeration	19	enumeration	20	enumeration	21
Kind	Value																																														
pattern	([0-9A-Z\-\ ]&quot;){1}([ 0-9A-Z&amp;] '\- . \./ \° \^ \( \) \À \È \É \  \Ò \Ù \Ü &quot; \  \ +)*																																														
enumeration	1																																														
enumeration	2																																														
enumeration	3																																														
enumeration	4																																														
enumeration	5																																														
enumeration	6																																														
enumeration	7																																														
enumeration	8																																														
enumeration	9																																														
enumeration	10																																														
enumeration	11																																														
enumeration	12																																														
enumeration	13																																														
enumeration	14																																														
enumeration	15																																														
enumeration	16																																														
enumeration	17																																														
enumeration	18																																														
enumeration	19																																														
enumeration	20																																														
enumeration	21																																														

#### element **Crediti\_F24\_Type/CredAddReg**

diagram					
namespace	urn:www.agenziaentrate.gov.it:specificheTecniche:sco:730				
type	<a href="#">DatoNP_Type</a>				
facets	<table border="1"> <thead> <tr> <th>Kind</th> <th>Value</th> </tr> </thead> <tbody> <tr> <td>pattern</td> <td>[1-9]{1}[0-9]*</td> </tr> </tbody> </table>	Kind	Value	pattern	[1-9]{1}[0-9]*
Kind	Value				
pattern	[1-9]{1}[0-9]*				

#### element **Crediti\_F24\_Type/CredAddRegDipNoSostituto**

diagram					
namespace	urn:www.agenziaentrate.gov.it:specificheTecniche:sco:730				
type	<a href="#">DatoNP_Type</a>				
facets	<table border="1"> <thead> <tr> <th>Kind</th> <th>Value</th> </tr> </thead> <tbody> <tr> <td>pattern</td> <td>[1-9]{1}[0-9]*</td> </tr> </tbody> </table>	Kind	Value	pattern	[1-9]{1}[0-9]*
Kind	Value				
pattern	[1-9]{1}[0-9]*				

**element Crediti\_F24\_Type/CodiceAddCom**

diagram	 m730:CodiceAddCom
namespace	urn:www.agenziaentrate.gov.it:specificheTecniche:sco:730
type	<a href="#">DatoAN_Type</a>
facets	Kind Value pattern ([0-9A-Z-] \&quot;){1}([ 0-9A-Z&amp;:] \- \., / \^\(\ \)\ À É Ì Ò Ù Û \&quot; \ \\ \+)*

**element Crediti\_F24\_Type/CredAddCom**

diagram	 m730:CredAddCom
namespace	urn:www.agenziaentrate.gov.it:specificheTecniche:sco:730
type	<a href="#">DatoNP_Type</a>
facets	Kind Value pattern [1-9]{1}[0-9]*

**element Crediti\_F24\_Type/CredAddComDipNoSostituto**

diagram	 m730:CredAddComDipNoSostitu...
namespace	urn:www.agenziaentrate.gov.it:specificheTecniche:sco:730
type	<a href="#">DatoNP_Type</a>
facets	Kind Value pattern [1-9]{1}[0-9]*

**element Crediti\_F24\_Type/CredCedolare**

diagram	 m730:CredCedolare
namespace	urn:www.agenziaentrate.gov.it:specificheTecniche:sco:730
type	<a href="#">DatoNP_Type</a>
facets	Kind Value pattern [1-9]{1}[0-9]*

**element Crediti\_F24\_Type/CredCedolareDipNoSostituto**

diagram	 m730:CredCedolareDipNoSostit...
namespace	urn:www.agenziaentrate.gov.it:specificheTecniche:sco:730
type	<a href="#">DatoNP_Type</a>

facets	Kind pattern	Value [1-9]{1}[0-9]*
--------	-----------------	-------------------------

**element Crediti\_F24\_Type/CredTassSeparDipNoSostituto**

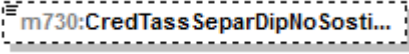
diagram		
namespace	urn:www.agenziaentrate.gov.it:specificheTecniche:sco:730	
type	<a href="#">DatoNP_Type</a>	
facets	Kind pattern	Value [1-9]{1}[0-9]*

**element Crediti\_F24\_Type/CredImpostaSostDipNoSostituto**

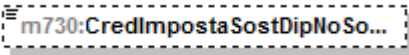
diagram		
namespace	urn:www.agenziaentrate.gov.it:specificheTecniche:sco:730	
type	<a href="#">DatoNP_Type</a>	
facets	Kind pattern	Value [1-9]{1}[0-9]*

**element Crediti\_F24\_Type/Totale**

diagram		
namespace	urn:www.agenziaentrate.gov.it:specificheTecniche:sco:730	
type	<a href="#">DatoNP_Type</a>	
facets	Kind pattern	Value [1-9]{1}[0-9]*

**element Crediti\_F24\_Type/TotaleDipNoSostituto**

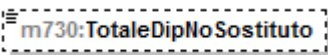
diagram		
namespace	urn:www.agenziaentrate.gov.it:specificheTecniche:sco:730	
type	<a href="#">DatoNP_Type</a>	
facets	Kind pattern	Value [1-9]{1}[0-9]*

complexType **Crediti\_Imposta\_Altri\_Sisma\_Abruzzo\_Type**

diagram	
namespace	urn:www.agenziaentrate.gov.it:specificheTecniche:sco:730
children	<a href="#">m730:Impresa_Professione</a> <a href="#">m730:CreditoImmobileSismaAbruzzo</a> <a href="#">m730:Rateazione</a>

element **Crediti\_Imposta\_Altri\_Sisma\_Abruzzo\_Type/Impresa\_Professione**

diagram					
namespace	urn:www.agenziaentrate.gov.it:specificheTecniche:sco:730				
type	<a href="#">DatoCB_Type</a>				
facets	<table border="1"> <thead> <tr> <th>Kind</th> <th>Value</th> </tr> </thead> <tbody> <tr> <td>pattern</td> <td>[01]</td> </tr> </tbody> </table>	Kind	Value	pattern	[01]
Kind	Value				
pattern	[01]				

element **Crediti\_Imposta\_Altri\_Sisma\_Abruzzo\_Type/CreditoImmobileSismaAbruzzo**

diagram	
namespace	urn:www.agenziaentrate.gov.it:specificheTecniche:sco:730
type	<a href="#">m730:Credito_Immobile_Sisma_Abruzzo_Type</a>
children	<a href="#">m730:CodiceFiscale</a> <a href="#">m730:NumeroRata</a> <a href="#">m730:TotaleCredito</a>

element **Crediti\_Imposta\_Altri\_Sisma\_Abruzzo\_Type/Rateazione**

diagram									
namespace	urn:www.agenziaentrate.gov.it:specificheTecniche:sco:730								
type	restriction of <a href="#">DatoNP_Type</a>								
facets	<table border="1"> <thead> <tr> <th>Kind</th> <th>Value</th> </tr> </thead> <tbody> <tr> <td>pattern</td> <td>[1-9]{1}[0-9]*</td> </tr> <tr> <td>enumeration</td> <td>5</td> </tr> <tr> <td>enumeration</td> <td>10</td> </tr> </tbody> </table>	Kind	Value	pattern	[1-9]{1}[0-9]*	enumeration	5	enumeration	10
Kind	Value								
pattern	[1-9]{1}[0-9]*								
enumeration	5								
enumeration	10								

complexType **Crediti\_Imposta\_Fabbricati\_Type**

diagram	
namespace	urn:www.agenziaentrate.gov.it:specificheTecniche:sco:730
children	<a href="#">m730:ResiduoFabbricati</a> <a href="#">m730:CanoniLocazioneNonPercepiti</a>

element **Crediti\_Imposta\_Fabbricati\_Type/ResiduoFabbricati**

diagram	
namespace	urn:www.agenziaentrate.gov.it:specificheTecniche:sco:730
type	<a href="#">m730:Residuo_Fabbricati_Type</a>
children	<a href="#">m730:ResiduoPrecedenteDichiarazione</a> <a href="#">m730:CreditoAnno</a> <a href="#">m730:DiCuiCompensatoF24</a>

element **Crediti\_Imposta\_Fabbricati\_Type/CanoniLocazioneNonPercepiti**

diagram					
namespace	urn:www.agenziaentrate.gov.it:specificheTecniche:sco:730				
type	<a href="#">DatoNP_Type</a>				
facets	<table border="1"> <thead> <tr> <th>Kind</th> <th>Value</th> </tr> </thead> <tbody> <tr> <td>pattern</td> <td>[1-9]{1}[0-9]*</td> </tr> </tbody> </table>	Kind	Value	pattern	[1-9]{1}[0-9]*
Kind	Value				
pattern	[1-9]{1}[0-9]*				

complexType **Crediti\_Imposta\_Fondi\_Pensione\_Type**

diagram	
namespace	urn:www.agenziaentrate.gov.it:specificheTecniche:sco:730

children	<a href="#">m730:AnnoAnticipazione</a> <a href="#">m730:Reintegro</a> <a href="#">m730:SommaReintegrata</a> <a href="#">m730:CreditoAnno</a>
----------	--

element **Crediti\_Imposta\_Fondi\_Pensione\_Type/AnnoAnticipazione**

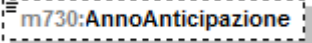
diagram																											
namespace	urn:www.agenziaentrate.gov.it:specificheTecniche:sco:730																										
type	<a href="#">m730:Anno Anticipazione Fondo Pensione Type</a>																										
facets	<table border="1"> <thead> <tr> <th>Kind</th> <th>Value</th> </tr> </thead> <tbody> <tr> <td>pattern</td> <td>[1-9]{1}[0-9]*</td> </tr> <tr> <td>enumeration</td> <td>2007</td> </tr> <tr> <td>enumeration</td> <td>2008</td> </tr> <tr> <td>enumeration</td> <td>2009</td> </tr> <tr> <td>enumeration</td> <td>2010</td> </tr> <tr> <td>enumeration</td> <td>2011</td> </tr> <tr> <td>enumeration</td> <td>2012</td> </tr> <tr> <td>enumeration</td> <td>2013</td> </tr> <tr> <td>enumeration</td> <td>2014</td> </tr> <tr> <td>enumeration</td> <td>2015</td> </tr> <tr> <td>enumeration</td> <td>2016</td> </tr> <tr> <td>enumeration</td> <td>2017</td> </tr> </tbody> </table>	Kind	Value	pattern	[1-9]{1}[0-9]*	enumeration	2007	enumeration	2008	enumeration	2009	enumeration	2010	enumeration	2011	enumeration	2012	enumeration	2013	enumeration	2014	enumeration	2015	enumeration	2016	enumeration	2017
Kind	Value																										
pattern	[1-9]{1}[0-9]*																										
enumeration	2007																										
enumeration	2008																										
enumeration	2009																										
enumeration	2010																										
enumeration	2011																										
enumeration	2012																										
enumeration	2013																										
enumeration	2014																										
enumeration	2015																										
enumeration	2016																										
enumeration	2017																										

element **Crediti\_Imposta\_Fondi\_Pensione\_Type/Reintegro**

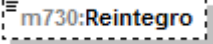
diagram									
namespace	urn:www.agenziaentrate.gov.it:specificheTecniche:sco:730								
type	<a href="#">m730:Reintegro Totale Parziale Type</a>								
facets	<table border="1"> <thead> <tr> <th>Kind</th> <th>Value</th> </tr> </thead> <tbody> <tr> <td>pattern</td> <td>[1-9]</td> </tr> <tr> <td>enumeration</td> <td>1</td> </tr> <tr> <td>enumeration</td> <td>2</td> </tr> </tbody> </table>	Kind	Value	pattern	[1-9]	enumeration	1	enumeration	2
Kind	Value								
pattern	[1-9]								
enumeration	1								
enumeration	2								

element **Crediti\_Imposta\_Fondi\_Pensione\_Type/SommaReintegrata**

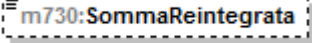
diagram					
namespace	urn:www.agenziaentrate.gov.it:specificheTecniche:sco:730				
type	<a href="#">DatoNP Type</a>				
facets	<table border="1"> <thead> <tr> <th>Kind</th> <th>Value</th> </tr> </thead> <tbody> <tr> <td>pattern</td> <td>[1-9]{1}[0-9]*</td> </tr> </tbody> </table>	Kind	Value	pattern	[1-9]{1}[0-9]*
Kind	Value				
pattern	[1-9]{1}[0-9]*				

element **Crediti\_Imposta\_Fondi\_Pensione\_Type/CreditoAnno**

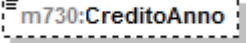
diagram	
namespace	urn:www.agenziaentrate.gov.it:specificheTecniche:sco:730
type	<a href="#">DatoNP Type</a>

facets	Kind pattern	Value [1-9]{1}[0-9]*
--------	-----------------	-------------------------

### complexType **Crediti\_Imposta\_Reddit\_Esteri\_Type**

diagram	
namespace	urn:www.agenziaentrate.gov.it:specificheTecniche:sco:730
children	<a href="#">m730:StatoEstero</a> <a href="#">m730:Anno</a> <a href="#">m730:RedditoEstero</a> <a href="#">m730:ImpostaEstera</a> <a href="#">m730:RedditoComplessivo</a> <a href="#">m730:Imposta_Lorda</a> <a href="#">m730:ImpostaNetta</a> <a href="#">m730:CreditoDichiarazioniPrecedenti</a> <a href="#">m730:DiCuiStatoEstero</a>

### element **Crediti\_Imposta\_Reddit\_Esteri\_Type/StatoEstero**

diagram	
namespace	urn:www.agenziaentrate.gov.it:specificheTecniche:sco:730
type	<a href="#">DatoAN_Type</a>
facets	Kind Value pattern ([0-9A-Z-] \&quot;){1}([ 0-9A-Z&amp;:] ' - \., / ^ \^\(\/\) À È É Ì Ò Ù Û &quot; \ \\ / +)*

### element **Crediti\_Imposta\_Reddit\_Esteri\_Type/Anno**

diagram	
namespace	urn:www.agenziaentrate.gov.it:specificheTecniche:sco:730
type	restriction of <a href="#">DatoDA_Type</a>
facets	Kind Value pattern (18 19 20)[0-9]{2}

element **Crediti\_Imposta\_Redditi\_Esteri\_Type/RedditoEstero**

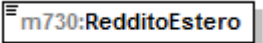
diagram	
namespace	urn:www.agenziaentrate.gov.it:specificheTecniche:sco:730
type	<a href="#">DatoNP_Type</a>
facets	Kind Value pattern [1-9]{1}[0-9]*

element **Crediti\_Imposta\_Redditi\_Esteri\_Type/ImpostaEstera**

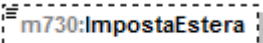
diagram	
namespace	urn:www.agenziaentrate.gov.it:specificheTecniche:sco:730
type	<a href="#">DatoNP_Type</a>
facets	Kind Value pattern [1-9]{1}[0-9]*

element **Crediti\_Imposta\_Redditi\_Esteri\_Type/RedditoComplessivo**

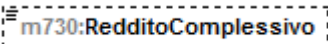
diagram	
namespace	urn:www.agenziaentrate.gov.it:specificheTecniche:sco:730
type	<a href="#">DatoNP_Type</a>
facets	Kind Value pattern [1-9]{1}[0-9]*

element **Crediti\_Imposta\_Redditi\_Esteri\_Type/Imposta\_Lorda**

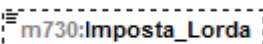
diagram	
namespace	urn:www.agenziaentrate.gov.it:specificheTecniche:sco:730
type	<a href="#">DatoNP_Type</a>
facets	Kind Value pattern [1-9]{1}[0-9]*

element **Crediti\_Imposta\_Redditi\_Esteri\_Type/ImpostaNetta**

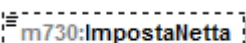
diagram	
namespace	urn:www.agenziaentrate.gov.it:specificheTecniche:sco:730
type	<a href="#">DatoNP_Type</a>
facets	Kind Value pattern [1-9]{1}[0-9]*

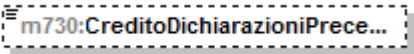

element **Crediti\_Imposta\_Reddit\_Esteri\_Type/CreditoDichiarazioniPrecedenti**

diagram	
namespace	urn:www.agenziaentrate.gov.it:specificheTecniche:sco:730
type	<a href="#">DatoNP_Type</a>
facets	Kind Value pattern [1-9]{1}[0-9]*

element **Crediti\_Imposta\_Reddit\_Esteri\_Type/DiCuiStatoEstero**

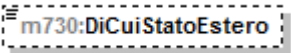
diagram	
namespace	urn:www.agenziaentrate.gov.it:specificheTecniche:sco:730
type	<a href="#">DatoNP_Type</a>
facets	Kind Value pattern [1-9]{1}[0-9]*

complexType **Crediti\_Imposta\_Type**

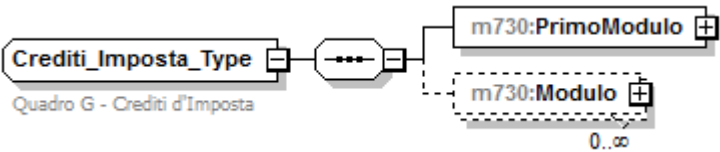
diagram	
namespace	urn:www.agenziaentrate.gov.it:specificheTecniche:sco:730
children	<a href="#">m730:PrimoModulo</a> <a href="#">m730:Modulo</a>

element **Crediti\_Imposta\_Type/PrimoModulo**

<p>diagram</p>	
<p>namespace</p>	<p>urn:www.agenziaentrate.gov.it:specificheTecniche:sco:730</p>
<p>type</p>	<p><a href="#">m730:Primo_Modulo_Crediti_Imposta_Type</a></p>
<p>children</p>	<p><a href="#">m730:CreditoImpostaFabbricati</a> <a href="#">m730:CreditoImpostaFondiPensione</a> <a href="#">m730:CreditoImpostaRedditiEsteri</a> <a href="#">m730:CreditoPrimaCasaSismaAbruzzo</a> <a href="#">m730:CreditoAltriSismaAbruzzo</a> <a href="#">m730:CreditoIncrementoOccupazione</a> <a href="#">m730:CreditoImpostaMediazioni</a> <a href="#">m730:CreditoErogazioniCultura</a> <a href="#">m730:CreditoNegoziazione</a> <a href="#">m730:CreditoErogazioniScuola</a> <a href="#">m730:CreditoVideosorveglianza</a></p>

element **Crediti\_Imposta\_Type/Modulo**

<p>diagram</p>	
<p>namespace</p>	<p>urn:www.agenziaentrate.gov.it:specificheTecniche:sco:730</p>

type	<a href="#">m730:Modulo_Crediti_Imposta_Type</a>
children	<a href="#">m730:CreditoImpostaFondiPensione</a> <a href="#">m730:CreditoImpostaRedditiEsteri</a> <a href="#">m730:CreditoPrimaCasaSismaAbruzzo</a> <a href="#">m730:CreditoAltriSismaAbruzzo</a> <a href="#">m730:CreditoNegoziazione</a>

### complexType **Credito\_Erogazioni\_Cultura\_Type**

diagram	
namespace	urn:www.agenziaentrate.gov.it:specificheTecniche:sco:730
children	<a href="#">m730:SpesaAnno</a> <a href="#">m730:ResiduoAnnoPrec</a> <a href="#">m730:RataAnnoPrec</a> <a href="#">m730:RataDueAnniPrec</a>

### element **Credito\_Erogazioni\_Cultura\_Type/SpesaAnno**

diagram					
namespace	urn:www.agenziaentrate.gov.it:specificheTecniche:sco:730				
type	<a href="#">DatoNP_Type</a>				
facets	<table border="1"> <tr> <td>Kind</td> <td>Value</td> </tr> <tr> <td>pattern</td> <td>[1-9]{1}[0-9]*</td> </tr> </table>	Kind	Value	pattern	[1-9]{1}[0-9]*
Kind	Value				
pattern	[1-9]{1}[0-9]*				

### element **Credito\_Erogazioni\_Cultura\_Type/ResiduoAnnoPrec**

diagram					
namespace	urn:www.agenziaentrate.gov.it:specificheTecniche:sco:730				
type	<a href="#">DatoNP_Type</a>				
facets	<table border="1"> <tr> <td>Kind</td> <td>Value</td> </tr> <tr> <td>pattern</td> <td>[1-9]{1}[0-9]*</td> </tr> </table>	Kind	Value	pattern	[1-9]{1}[0-9]*
Kind	Value				
pattern	[1-9]{1}[0-9]*				

### element **Credito\_Erogazioni\_Cultura\_Type/RataAnnoPrec**

diagram					
namespace	urn:www.agenziaentrate.gov.it:specificheTecniche:sco:730				
type	<a href="#">DatoNP_Type</a>				
facets	<table border="1"> <tr> <td>Kind</td> <td>Value</td> </tr> <tr> <td>pattern</td> <td>[1-9]{1}[0-9]*</td> </tr> </table>	Kind	Value	pattern	[1-9]{1}[0-9]*
Kind	Value				
pattern	[1-9]{1}[0-9]*				

element **Credito\_Erogazioni\_Cultura\_Type/RataDueAnniPrec**

diagram					
namespace	urn:www.agenziaentrate.gov.it:specificheTecniche:sco:730				
type	<a href="#">DatoNP_Type</a>				
facets	<table border="1"> <tr> <td>Kind</td> <td>Value</td> </tr> <tr> <td>pattern</td> <td>[1-9]{1}[0-9]*</td> </tr> </table>	Kind	Value	pattern	[1-9]{1}[0-9]*
Kind	Value				
pattern	[1-9]{1}[0-9]*				

complexType **Credito\_Erogazioni\_Scuola\_Type**

diagram	
namespace	urn:www.agenziaentrate.gov.it:specificheTecniche:sco:730
children	<a href="#">m730:SpesaAnno</a> <a href="#">m730:SpesaAnnoPrec</a> <a href="#">m730:ResiduoAnnoPrec</a>

element **Credito\_Erogazioni\_Scuola\_Type/SpesaAnno**

diagram					
namespace	urn:www.agenziaentrate.gov.it:specificheTecniche:sco:730				
type	<a href="#">DatoNP_Type</a>				
facets	<table border="1"> <tr> <td>Kind</td> <td>Value</td> </tr> <tr> <td>pattern</td> <td>[1-9]{1}[0-9]*</td> </tr> </table>	Kind	Value	pattern	[1-9]{1}[0-9]*
Kind	Value				
pattern	[1-9]{1}[0-9]*				

element **Credito\_Erogazioni\_Scuola\_Type/SpesaAnnoPrec**

diagram					
namespace	urn:www.agenziaentrate.gov.it:specificheTecniche:sco:730				
type	<a href="#">DatoNP_Type</a>				
facets	<table border="1"> <tr> <td>Kind</td> <td>Value</td> </tr> <tr> <td>pattern</td> <td>[1-9]{1}[0-9]*</td> </tr> </table>	Kind	Value	pattern	[1-9]{1}[0-9]*
Kind	Value				
pattern	[1-9]{1}[0-9]*				

element **Credito\_Erogazioni\_Scuola\_Type/ResiduoAnnoPrec**

diagram	
namespace	urn:www.agenziaentrate.gov.it:specificheTecniche:sco:730

type	<a href="#">DatoNP_Type</a>
facets	Kind Value pattern [1-9]{1}[0-9]*

### complexType Credito\_Immobile\_Sisma\_Abruzzo\_Type

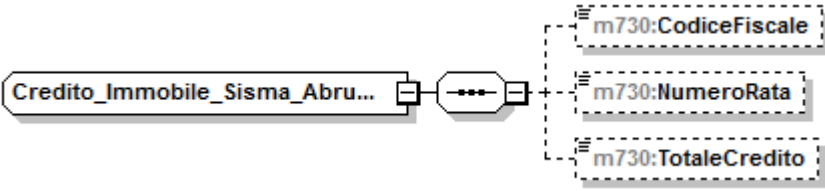
diagram	
namespace	urn:www.agenziaentrate.gov.it:specificheTecniche:sco:730
children	<a href="#">m730:CodiceFiscale</a> <a href="#">m730:NumeroRata</a> <a href="#">m730:TotaleCredito</a>

### element Credito\_Immobile\_Sisma\_Abruzzo\_Type/CodiceFiscale

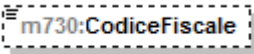
diagram	
namespace	urn:www.agenziaentrate.gov.it:specificheTecniche:sco:730
type	<a href="#">DatoCF_Type</a>
facets	Kind Value pattern [0-9]{11}[A-Z]{6}[0-9LMNPQRSTU]{2}[A-Z]{1}[0-9LMNPQRSTU]{2}[A-Z]{1}[0-9LMNPQRSTU]{3}[A-Z]{1}

### element Credito\_Immobile\_Sisma\_Abruzzo\_Type/NumeroRata

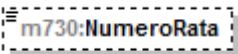
diagram	
namespace	urn:www.agenziaentrate.gov.it:specificheTecniche:sco:730
type	restriction of <a href="#">DatoNP_Type</a>
facets	Kind Value pattern [1-9]{1}[0-9]* enumeration 1 enumeration 2 enumeration 3 enumeration 4 enumeration 5 enumeration 6 enumeration 7 enumeration 8 enumeration 9

### element Credito\_Immobile\_Sisma\_Abruzzo\_Type/TotaleCredito

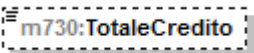
diagram	
namespace	urn:www.agenziaentrate.gov.it:specificheTecniche:sco:730

type	<a href="#">DatoNP_Type</a>
facets	Kind Value pattern [1-9]{1}[0-9]*

#### complexType **Credito\_Incremento\_Occupazione\_Type**

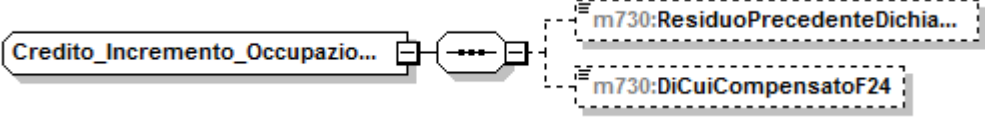
diagram	
namespace	urn:www.agenziaentrate.gov.it:specificheTecniche:sco:730
children	<a href="#">m730:ResiduoPrecedenteDichiarazione</a> <a href="#">m730:DiCuiCompensatoF24</a>

#### element **Credito\_Incremento\_Occupazione\_Type/ResiduoPrecedenteDichiarazione**

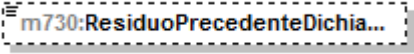
diagram	
namespace	urn:www.agenziaentrate.gov.it:specificheTecniche:sco:730
type	<a href="#">DatoNP_Type</a>
facets	Kind Value pattern [1-9]{1}[0-9]*

#### element **Credito\_Incremento\_Occupazione\_Type/DiCuiCompensatoF24**

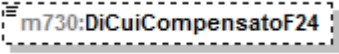
diagram	
namespace	urn:www.agenziaentrate.gov.it:specificheTecniche:sco:730
type	<a href="#">DatoNP_Type</a>
facets	Kind Value pattern [1-9]{1}[0-9]*

#### complexType **Credito\_Negoziatore\_Type**

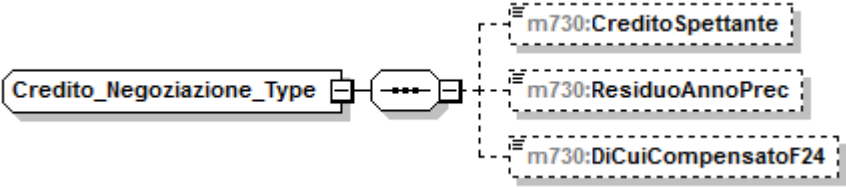
diagram	
namespace	urn:www.agenziaentrate.gov.it:specificheTecniche:sco:730
children	<a href="#">m730:CreditoSpettante</a> <a href="#">m730:ResiduoAnnoPrec</a> <a href="#">m730:DiCuiCompensatoF24</a>

element **Credito\_Negoziatore\_Type/CreditoSpettante**

diagram	
namespace	urn:www.agenziaentrate.gov.it:specificheTecniche:sco:730
type	<a href="#">DatoNP_Type</a>
facets	Kind Value pattern [1-9]{1}[0-9]*

element **Credito\_Negoziatore\_Type/ResiduoAnnoPrec**

diagram	
namespace	urn:www.agenziaentrate.gov.it:specificheTecniche:sco:730
type	<a href="#">DatoNP_Type</a>
facets	Kind Value pattern [1-9]{1}[0-9]*

element **Credito\_Negoziatore\_Type/DiCuiCompensatoF24**

diagram	
namespace	urn:www.agenziaentrate.gov.it:specificheTecniche:sco:730
type	<a href="#">DatoNP_Type</a>
facets	Kind Value pattern [1-9]{1}[0-9]*

complexType **Credito\_Stato\_Type**

diagram	
namespace	urn:www.agenziaentrate.gov.it:specificheTecniche:sco:730
children	<a href="#">m730:Stato</a> <a href="#">m730:Credito</a>

element **Credito\_Stato\_Type/Stato**

diagram	
namespace	urn:www.agenziaentrate.gov.it:specificheTecniche:sco:730
type	<a href="#">DatoAN_Type</a>
facets	Kind Value pattern ([0-9A-Z-] \&quot;){1}([ 0-9A-Z&amp;] ' \" \- \., / ° ^\(\\ )\) À È É Ì Ò Ù Û &quot; \\ / +)*

element **Credito\_Stato\_Type/Credito**

diagram					
namespace	urn:www.agenziaentrate.gov.it:specificheTecniche:sco:730				
type	<a href="#">DatoNP_Type</a>				
facets	<table border="1"> <tr> <td>Kind</td> <td>Value</td> </tr> <tr> <td>pattern</td> <td>[1-9]{1}[0-9]*</td> </tr> </table>	Kind	Value	pattern	[1-9]{1}[0-9]*
Kind	Value				
pattern	[1-9]{1}[0-9]*				

complexType **Credito\_Type**

diagram	
namespace	urn:www.agenziaentrate.gov.it:specificheTecniche:sco:730
children	<a href="#">m730:NonRimborsabile</a> <a href="#">m730:Credito</a> <a href="#">m730:CreditoF24</a> <a href="#">m730:CreditoRimborso</a>

element **Credito\_Type/NonRimborsabile**

diagram					
namespace	urn:www.agenziaentrate.gov.it:specificheTecniche:sco:730				
type	<a href="#">DatoNP_Type</a>				
facets	<table border="1"> <tr> <td>Kind</td> <td>Value</td> </tr> <tr> <td>pattern</td> <td>[1-9]{1}[0-9]*</td> </tr> </table>	Kind	Value	pattern	[1-9]{1}[0-9]*
Kind	Value				
pattern	[1-9]{1}[0-9]*				

element **Credito\_Type/Credito**

diagram					
namespace	urn:www.agenziaentrate.gov.it:specificheTecniche:sco:730				
type	<a href="#">DatoNP_Type</a>				
facets	<table border="1"> <tr> <td>Kind</td> <td>Value</td> </tr> <tr> <td>pattern</td> <td>[1-9]{1}[0-9]*</td> </tr> </table>	Kind	Value	pattern	[1-9]{1}[0-9]*
Kind	Value				
pattern	[1-9]{1}[0-9]*				

element **Credito\_Type/CreditoF24**

diagram	
---------	--



namespace	urn:www.agenziaentrate.gov.it:specificheTecniche:sco:730
type	<a href="#">DatoNP_Type</a>
facets	Kind Value pattern [1-9]{1}[0-9]*

#### element **Credito\_Type/CreditoRimborso**

diagram	
namespace	urn:www.agenziaentrate.gov.it:specificheTecniche:sco:730
type	<a href="#">DatoNP_Type</a>
facets	Kind Value pattern [1-9]{1}[0-9]*

#### complexType **Credito\_Videosorveglianza\_Type**

diagram	
namespace	urn:www.agenziaentrate.gov.it:specificheTecniche:sco:730
children	<a href="#">m730:ResiduoAnnoPrec</a> <a href="#">m730:DiCuiCompensatoF24</a>

#### element **Credito\_Videosorveglianza\_Type/ResiduoAnnoPrec**

diagram	
namespace	urn:www.agenziaentrate.gov.it:specificheTecniche:sco:730
type	<a href="#">DatoNP_Type</a>
facets	Kind Value pattern [1-9]{1}[0-9]*

#### element **Credito\_Videosorveglianza\_Type/DiCuiCompensatoF24**

diagram	
namespace	urn:www.agenziaentrate.gov.it:specificheTecniche:sco:730
type	<a href="#">DatoNP_Type</a>
facets	Kind Value pattern [1-9]{1}[0-9]*

complexType **Dati\_730\_Integrativo\_Type**

diagram	
namespace	urn:www.agenziaentrate.gov.it:specificheTecniche:sco:730
children	<a href="#">m730:Rimborso</a> <a href="#">m730:Credito</a>

element **Dati\_730\_Integrativo\_Type/Rimborso**

diagram	
namespace	urn:www.agenziaentrate.gov.it:specificheTecniche:sco:730
type	<a href="#">m730:Elemento_Integrativo_Type</a>
children	<a href="#">m730:Irpef</a> <a href="#">m730:AddizionaleRegionaleIrpef</a> <a href="#">m730:AddComunaleIrpef</a> <a href="#">m730:CedolareSecca</a>

element **Dati\_730\_Integrativo\_Type/Credito**

diagram	
namespace	urn:www.agenziaentrate.gov.it:specificheTecniche:sco:730
type	<a href="#">m730:Elemento_Integrativo_Type</a>
children	<a href="#">m730:Irpef</a> <a href="#">m730:AddizionaleRegionaleIrpef</a> <a href="#">m730:AddComunaleIrpef</a> <a href="#">m730:CedolareSecca</a>

complexType **Dati\_Altr\_e\_Detra\_zioni\_Modulo\_Type**

diagram	
namespace	urn:www.agenziaentrate.gov.it:specificheTecniche:sco:730
children	<a href="#">m730:Altr_e_Detra_zioni</a>

element **Dati\_Altr\_e\_Detra\_zioni\_Modulo\_Type/Altr\_e\_Detra\_zioni**

diagram	
namespace	urn:www.agenziaentrate.gov.it:specificheTecniche:sco:730
type	<a href="#">m730:Altr_e_Detra_zioni_Type</a>
children	<a href="#">m730:Codice</a> <a href="#">m730:Importo</a>

complexType **Dati\_Altr\_e\_Detra\_zioni\_Type**

diagram	
namespace	urn:www.agenziaentrate.gov.it:specificheTecniche:sco:730
children	<a href="#">m730:SpeseCaniGuida</a> <a href="#">m730:AffittoTerreniAgricoliGiovani</a> <a href="#">m730:Altr_e_Detra_zioni</a>

element **Dati\_Altr\_e\_Detra\_zioni\_Type/SpeseCaniGuida**

diagram					
namespace	urn:www.agenziaentrate.gov.it:specificheTecniche:sco:730				
type	<a href="#">DatoCB_Type</a>				
facets	<table border="1"> <thead> <tr> <th>Kind</th> <th>Value</th> </tr> </thead> <tbody> <tr> <td>pattern</td> <td>[01]</td> </tr> </tbody> </table>	Kind	Value	pattern	[01]
Kind	Value				
pattern	[01]				

element **Dati\_Altr\_e\_Detra\_zioni\_Type/AffittoTerreniAgricoliGiovani**

diagram	
---------	--

namespace	urn:www.agenziaentrate.gov.it:specificheTecniche:sco:730	
type	<a href="#">DatoNP_Type</a>	
facets	Kind	Value
	pattern	[1-9]{1}[0-9]*

#### element **Dati\_Altre\_Detrazioni\_Type/AltreDetrazioni**

diagram		
namespace	urn:www.agenziaentrate.gov.it:specificheTecniche:sco:730	
type	<a href="#">m730:Altre_Detrazioni_Type</a>	
children	<a href="#">m730:Codice</a> <a href="#">m730:Importo</a>	

#### complexType **Dati\_Associazioni\_Professionale\_Type**

diagram		
namespace	urn:www.agenziaentrate.gov.it:specificheTecniche:sco:730	
children	<a href="#">m730:CFAssociazione</a> <a href="#">m730:DenominazioneAssociazione</a> <a href="#">m730:CFProfessionista</a> <a href="#">m730:CognomeProfessionista</a> <a href="#">m730:NomeProfessionista</a>	

#### element **Dati\_Associazioni\_Professionale\_Type/CFAssociazione**

diagram		
namespace	urn:www.agenziaentrate.gov.it:specificheTecniche:sco:730	
type	<a href="#">DatoCN_Type</a>	
facets	Kind	Value
	pattern	[0-9]{11}

element **Dati\_Associazioni\_Professionale\_Type/DenominazioneAssociazione**

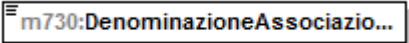
diagram	
namespace	urn:www.agenziaentrate.gov.it:specificheTecniche:sco:730
type	<a href="#">DatoAN_Type</a>
facets	Kind Value pattern (([0-9A-Z-]*)&quot;){1}([ 0-9A-Z&amp;:] ' \" \\( \\) À É È Ì Ò Ù Ü &quot; \\ \\ \\ +)*

element **Dati\_Associazioni\_Professionale\_Type/CFProfessionista**

diagram	
namespace	urn:www.agenziaentrate.gov.it:specificheTecniche:sco:730
type	<a href="#">DatoCF_Type</a>
facets	Kind Value pattern [0-9]{11}[A-Z]{6}[0-9LMNPQRSTU]{2}[A-Z]{1}[0-9LMNPQRSTU]{2}[A-Z]{1}[0-9LMNPQRSTU]{3}[A-Z]{1}

element **Dati\_Associazioni\_Professionale\_Type/CognomeProfessionista**

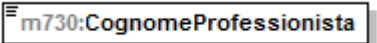
diagram	
namespace	urn:www.agenziaentrate.gov.it:specificheTecniche:sco:730
type	<a href="#">DatoAN_Type</a>
facets	Kind Value pattern (([0-9A-Z-]*)&quot;){1}([ 0-9A-Z&amp;:] ' \" \\( \\) À É È Ì Ò Ù Ü &quot; \\ \\ \\ +)*

element **Dati\_Associazioni\_Professionale\_Type/NomeProfessionista**

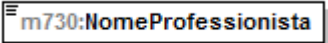
diagram	
namespace	urn:www.agenziaentrate.gov.it:specificheTecniche:sco:730
type	<a href="#">DatoAN_Type</a>
facets	Kind Value pattern (([0-9A-Z-]*)&quot;){1}([ 0-9A-Z&amp;:] ' \" \\( \\) À É È Ì Ò Ù Ü &quot; \\ \\ \\ +)*

complexType **Dati\_CAF\_Type**

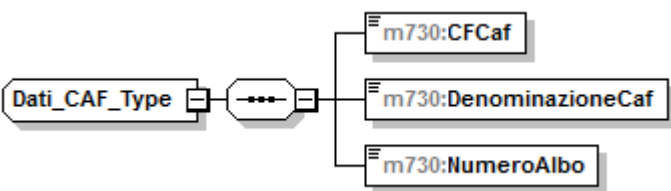
diagram	
namespace	urn:www.agenziaentrate.gov.it:specificheTecniche:sco:730

children	<a href="#">m730:CFCaf</a> <a href="#">m730:DenominazioneCaf</a> <a href="#">m730:NumeroAlbo</a>
----------	--

#### element **Dati\_CAF\_Type/CFCaf**

diagram	
namespace	urn:www.agenziaentrate.gov.it:specificheTecniche:sco:730
type	<a href="#">DatoCN_Type</a>
facets	Kind Value pattern [0-9]{11}

#### element **Dati\_CAF\_Type/DenominazioneCaf**

diagram	
namespace	urn:www.agenziaentrate.gov.it:specificheTecniche:sco:730
type	<a href="#">DatoAN_Type</a>
facets	Kind Value pattern (([0-9A-Z-] \&quot;){1})([ 0-9A-Z&amp;:] \- \., / \^\(\ \)\ À É È Ì Ò Ù Û &quot; \ \\ \ +)*

#### element **Dati\_CAF\_Type/NumeroAlbo**

diagram	
namespace	urn:www.agenziaentrate.gov.it:specificheTecniche:sco:730
type	restriction of <a href="#">DatoNP_Type</a>
facets	Kind Value pattern [1-9]{1}[0-9]*

#### complexType **Dati\_Catastali\_Recupero\_Patrimonio\_Edilizio\_Type**

diagram	
namespace	urn:www.agenziaentrate.gov.it:specificheTecniche:sco:730
children	<a href="#">m730:NOrdImmobile</a> <a href="#">m730:Condominio</a> <a href="#">m730:DatiCatastali</a>

element **Dati\_Catastali\_Recupero\_Patrimonio\_Edilizio\_Type/NOrdImmobile**

diagram	
namespace	urn:www.agenziaentrate.gov.it:specificheTecniche:sco:730
type	<a href="#">DatoNP_Type</a>
facets	Kind Value pattern [1-9]{1}[0-9]*

element **Dati\_Catastali\_Recupero\_Patrimonio\_Edilizio\_Type/Condominio**

diagram	
namespace	urn:www.agenziaentrate.gov.it:specificheTecniche:sco:730
type	<a href="#">DatoCB_Type</a>
facets	Kind Value pattern [01]

element **Dati\_Catastali\_Recupero\_Patrimonio\_Edilizio\_Type/DatiCatastali**

diagram	
namespace	urn:www.agenziaentrate.gov.it:specificheTecniche:sco:730
type	<a href="#">m730:Dati_Catastali_Type</a>
children	<a href="#">m730:CodiceComune</a> <a href="#">m730:TerreniUrbano</a> <a href="#">m730:SezioneUrbanaComuneCatastale</a> <a href="#">m730:Foglio</a> <a href="#">m730:Particella</a> <a href="#">m730:Subalterno</a>

complexType **Dati\_Catastali\_Type**

diagram	
namespace	urn:www.agenziaentrate.gov.it:specificheTecniche:sco:730
children	<a href="#">m730:CodiceComune</a> <a href="#">m730:TerreniUrbano</a> <a href="#">m730:SezioneUrbanaComuneCatastale</a> <a href="#">m730:Foglio</a> <a href="#">m730:Particella</a> <a href="#">m730:Subalterno</a>

element **Dati\_Catastali\_Type/CodiceComune**

diagram					
namespace	urn:www.agenziaentrate.gov.it:specificheTecniche:sco:730				
type	<a href="#">DatoAN_Type</a>				
facets	<table border="0"> <tr> <td>Kind</td> <td>Value</td> </tr> <tr> <td>pattern</td> <td>(([0-9A-Z\-\]]&amp;quot;){1}([ 0-9A-Z&amp;amp;]] \- \., / ^ \^\(\\) À È É Ì Ò Ù Ü &amp;quot; \\ / +)*</td> </tr> </table>	Kind	Value	pattern	(([0-9A-Z\-\]]&quot;){1}([ 0-9A-Z&amp;]] \- \., / ^ \^\(\\) À È É Ì Ò Ù Ü &quot; \\ / +)*
Kind	Value				
pattern	(([0-9A-Z\-\]]&quot;){1}([ 0-9A-Z&amp;]] \- \., / ^ \^\(\\) À È É Ì Ò Ù Ü &quot; \\ / +)*				

element **Dati\_Catastali\_Type/TerreniUrbano**

diagram									
namespace	urn:www.agenziaentrate.gov.it:specificheTecniche:sco:730								
type	<a href="#">m730:Terreni Urbano_Type</a>								
facets	<table border="0"> <tr> <td>Kind</td> <td>Value</td> </tr> <tr> <td>pattern</td> <td>(([0-9A-Z\-\]]&amp;quot;){1}([ 0-9A-Z&amp;amp;]] \- \., / ^ \^\(\\) À È É Ì Ò Ù Ü &amp;quot; \\ / +)*</td> </tr> <tr> <td>enumeration</td> <td>T</td> </tr> <tr> <td>enumeration</td> <td>U</td> </tr> </table>	Kind	Value	pattern	(([0-9A-Z\-\]]&quot;){1}([ 0-9A-Z&amp;]] \- \., / ^ \^\(\\) À È É Ì Ò Ù Ü &quot; \\ / +)*	enumeration	T	enumeration	U
Kind	Value								
pattern	(([0-9A-Z\-\]]&quot;){1}([ 0-9A-Z&amp;]] \- \., / ^ \^\(\\) À È É Ì Ò Ù Ü &quot; \\ / +)*								
enumeration	T								
enumeration	U								

element **Dati\_Catastali\_Type/SezioneUrbanaComuneCatastale**

diagram					
namespace	urn:www.agenziaentrate.gov.it:specificheTecniche:sco:730				
type	<a href="#">DatoAN_Type</a>				
facets	<table border="0"> <tr> <td>Kind</td> <td>Value</td> </tr> <tr> <td>pattern</td> <td>(([0-9A-Z\-\]]&amp;quot;){1}([ 0-9A-Z&amp;amp;]] \- \., / ^ \^\(\\) À È É Ì Ò Ù Ü &amp;quot; \\ / +)*</td> </tr> </table>	Kind	Value	pattern	(([0-9A-Z\-\]]&quot;){1}([ 0-9A-Z&amp;]] \- \., / ^ \^\(\\) À È É Ì Ò Ù Ü &quot; \\ / +)*
Kind	Value				
pattern	(([0-9A-Z\-\]]&quot;){1}([ 0-9A-Z&amp;]] \- \., / ^ \^\(\\) À È É Ì Ò Ù Ü &quot; \\ / +)*				



element **Dati\_Catastali\_Type/Foglio**

diagram	
namespace	urn:www.agenziaentrate.gov.it:specificheTecniche:sco:730
type	<a href="#">DatoAN_Type</a>
facets	Kind Value pattern ([0-9A-Z\-\] \&quot;){1}([ 0-9A-Z&amp;] '\- \., /'^\(\ \)\ À É È Ì Ò Ù Û &quot; \ \\ \ +)*

element **Dati\_Catastali\_Type/Particella**

diagram	
namespace	urn:www.agenziaentrate.gov.it:specificheTecniche:sco:730
children	<a href="#">m730:Numeratore</a> <a href="#">m730:Denominatore</a>

element **Dati\_Catastali\_Type/Particella/Numeratore**

diagram	
namespace	urn:www.agenziaentrate.gov.it:specificheTecniche:sco:730
type	<a href="#">DatoAN_Type</a>
facets	Kind Value pattern ([0-9A-Z\-\] \&quot;){1}([ 0-9A-Z&amp;] '\- \., /'^\(\ \)\ À É È Ì Ò Ù Û &quot; \ \\ \ +)*

element **Dati\_Catastali\_Type/Particella/Denominatore**

diagram	
namespace	urn:www.agenziaentrate.gov.it:specificheTecniche:sco:730
type	<a href="#">DatoAN_Type</a>
facets	Kind Value pattern ([0-9A-Z\-\] \&quot;){1}([ 0-9A-Z&amp;] '\- \., /'^\(\ \)\ À É È Ì Ò Ù Û &quot; \ \\ \ +)*

element **Dati\_Catastali\_Type/Subalterno**

diagram	
namespace	urn:www.agenziaentrate.gov.it:specificheTecniche:sco:730
type	<a href="#">DatoAN_Type</a>
facets	Kind Value pattern ([0-9A-Z\-\] \&quot;){1}([ 0-9A-Z&amp;] '\- \., /'^\(\ \)\ À É È Ì Ò Ù Û &quot; \ \\ \ +)*

### complexType Dati\_Condominio\_Type

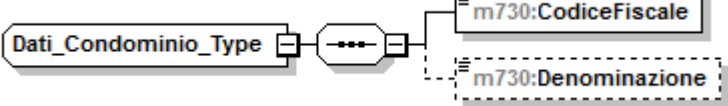
diagram	
namespace	urn:www.agenziaentrate.gov.it:specificheTecniche:sco:730
children	<a href="#">m730:CodiceFiscale</a> <a href="#">m730:Denominazione</a>

### element Dati\_Condominio\_Type/CodiceFiscale

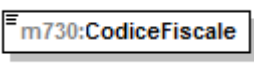
diagram					
namespace	urn:www.agenziaentrate.gov.it:specificheTecniche:sco:730				
type	<a href="#">DatoCF_Type</a>				
facets	<table border="1"> <thead> <tr> <th>Kind</th> <th>Value</th> </tr> </thead> <tbody> <tr> <td>pattern</td> <td>[0-9]{11}[A-Z]{6}[0-9LMNPQRSTUVWXYZ]{2}[A-Z]{1}[0-9LMNPQRSTUVWXYZ]{2}[A-Z]{1}[0-9LMNPQRSTUVWXYZ]{3}[A-Z]{1}</td> </tr> </tbody> </table>	Kind	Value	pattern	[0-9]{11}[A-Z]{6}[0-9LMNPQRSTUVWXYZ]{2}[A-Z]{1}[0-9LMNPQRSTUVWXYZ]{2}[A-Z]{1}[0-9LMNPQRSTUVWXYZ]{3}[A-Z]{1}
Kind	Value				
pattern	[0-9]{11}[A-Z]{6}[0-9LMNPQRSTUVWXYZ]{2}[A-Z]{1}[0-9LMNPQRSTUVWXYZ]{2}[A-Z]{1}[0-9LMNPQRSTUVWXYZ]{3}[A-Z]{1}				

### element Dati\_Condominio\_Type/Denominazione

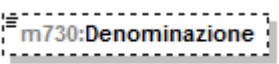
diagram					
namespace	urn:www.agenziaentrate.gov.it:specificheTecniche:sco:730				
type	<a href="#">DatoAN_Type</a>				
facets	<table border="1"> <thead> <tr> <th>Kind</th> <th>Value</th> </tr> </thead> <tbody> <tr> <td>pattern</td> <td>([0-9A-Z\-\-]\&amp;quot;){1}([ 0-9A-Z&amp;amp;:] \- \., / \° \^ \( \) \À \É \È \Ì \Ò \Ù \Û \&amp;quot; \ \\ \ +)*</td> </tr> </tbody> </table>	Kind	Value	pattern	([0-9A-Z\-\-]\&quot;){1}([ 0-9A-Z&amp;:] \- \., / \° \^ \( \) \À \É \È \Ì \Ò \Ù \Û \&quot; \ \\ \ +)*
Kind	Value				
pattern	([0-9A-Z\-\-]\&quot;){1}([ 0-9A-Z&amp;:] \- \., / \° \^ \( \) \À \É \È \Ì \Ò \Ù \Û \&quot; \ \\ \ +)*				

### complexType Dati\_Coniuge\_Type

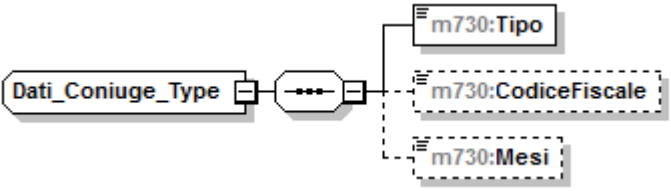
diagram	
namespace	urn:www.agenziaentrate.gov.it:specificheTecniche:sco:730
children	<a href="#">m730:Tipo</a> <a href="#">m730:CodiceFiscale</a> <a href="#">m730:Mesi</a>

### element Dati\_Coniuge\_Type/Tipo

diagram	
---------	---

namespace	urn:www.agenziaentrate.gov.it:specificheTecniche:sco:730				
type	<a href="#">DatoCB_Type</a>				
facets	<table border="1"> <thead> <tr> <th>Kind</th> <th>Value</th> </tr> </thead> <tbody> <tr> <td>pattern</td> <td>[01]</td> </tr> </tbody> </table>	Kind	Value	pattern	[01]
Kind	Value				
pattern	[01]				

**element Dati\_Coniuge\_Type/CodiceFiscale**

diagram					
namespace	urn:www.agenziaentrate.gov.it:specificheTecniche:sco:730				
type	<a href="#">DatoCF_Type</a>				
facets	<table border="1"> <thead> <tr> <th>Kind</th> <th>Value</th> </tr> </thead> <tbody> <tr> <td>pattern</td> <td>[0-9]{11}[[A-Z]{6}[0-9LMNPQRSTU]{2}[[A-Z]{1}[0-9LMNPQRSTU]{2}[[A-Z]{1}[0-9LMNPQRSTU]{3}[[A-Z]{1}</td> </tr> </tbody> </table>	Kind	Value	pattern	[0-9]{11}[[A-Z]{6}[0-9LMNPQRSTU]{2}[[A-Z]{1}[0-9LMNPQRSTU]{2}[[A-Z]{1}[0-9LMNPQRSTU]{3}[[A-Z]{1}
Kind	Value				
pattern	[0-9]{11}[[A-Z]{6}[0-9LMNPQRSTU]{2}[[A-Z]{1}[0-9LMNPQRSTU]{2}[[A-Z]{1}[0-9LMNPQRSTU]{3}[[A-Z]{1}				

**element Dati\_Coniuge\_Type/Mesi**

diagram																													
namespace	urn:www.agenziaentrate.gov.it:specificheTecniche:sco:730																												
type	<a href="#">m730:Mesi_Type</a>																												
facets	<table border="1"> <thead> <tr> <th>Kind</th> <th>Value</th> </tr> </thead> <tbody> <tr> <td>pattern</td> <td>[1-9]{1}[0-9]*</td> </tr> <tr> <td>enumeration</td> <td>1</td> </tr> <tr> <td>enumeration</td> <td>2</td> </tr> <tr> <td>enumeration</td> <td>3</td> </tr> <tr> <td>enumeration</td> <td>4</td> </tr> <tr> <td>enumeration</td> <td>5</td> </tr> <tr> <td>enumeration</td> <td>6</td> </tr> <tr> <td>enumeration</td> <td>7</td> </tr> <tr> <td>enumeration</td> <td>8</td> </tr> <tr> <td>enumeration</td> <td>9</td> </tr> <tr> <td>enumeration</td> <td>10</td> </tr> <tr> <td>enumeration</td> <td>11</td> </tr> <tr> <td>enumeration</td> <td>12</td> </tr> </tbody> </table>	Kind	Value	pattern	[1-9]{1}[0-9]*	enumeration	1	enumeration	2	enumeration	3	enumeration	4	enumeration	5	enumeration	6	enumeration	7	enumeration	8	enumeration	9	enumeration	10	enumeration	11	enumeration	12
Kind	Value																												
pattern	[1-9]{1}[0-9]*																												
enumeration	1																												
enumeration	2																												
enumeration	3																												
enumeration	4																												
enumeration	5																												
enumeration	6																												
enumeration	7																												
enumeration	8																												
enumeration	9																												
enumeration	10																												
enumeration	11																												
enumeration	12																												

complexType **Dati\_Contabili\_Type**

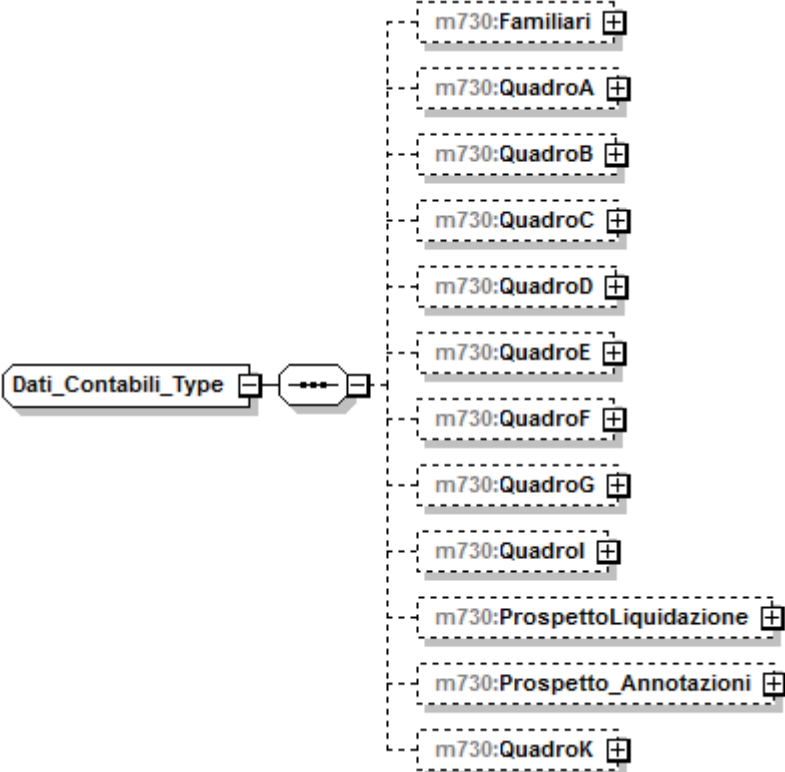
<p>diagram</p>	 <p>The diagram shows the structure of the <b>Dati_Contabili_Type</b> complex type. It is represented by a rounded rectangle with a small square on its left side. A dashed line connects this rectangle to a central octagonal connector containing three dots. From this connector, a vertical dashed line leads to a list of child elements, each enclosed in a dashed box with a small square on its left side and a plus sign in a square on its right side. The child elements are: <b>m730:Familiari</b>, <b>m730:QuadroA</b>, <b>m730:QuadroB</b>, <b>m730:QuadroC</b>, <b>m730:QuadroD</b>, <b>m730:QuadroE</b>, <b>m730:QuadroF</b>, <b>m730:QuadroG</b>, <b>m730:QuadroI</b>, <b>m730:ProspettoLiquidazione</b>, <b>m730:Prospetto_Annotazioni</b>, and <b>m730:QuadroK</b>.</p>
<p>namespace</p>	<p>urn:www.agenziaentrate.gov.it:specificheTecniche:sco:730</p>
<p>children</p>	<p><a href="#">m730:Familiari</a> <a href="#">m730:QuadroA</a> <a href="#">m730:QuadroB</a> <a href="#">m730:QuadroC</a> <a href="#">m730:QuadroD</a> <a href="#">m730:QuadroE</a> <a href="#">m730:QuadroF</a> <a href="#">m730:QuadroG</a> <a href="#">m730:QuadroI</a> <a href="#">m730:ProspettoLiquidazione</a> <a href="#">m730:Prospetto_Annotazioni</a> <a href="#">m730:QuadroK</a></p>

element **Dati\_Contabili\_Type/Familiari**

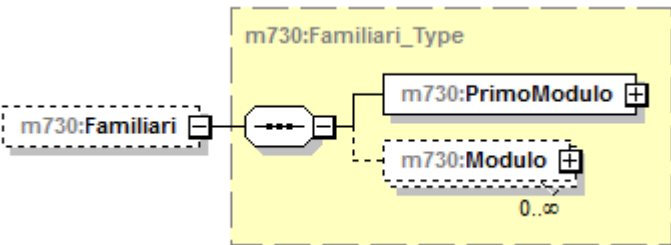
<p>diagram</p>	 <p>The diagram shows the structure of the <b>m730:Familiari</b> element. It is represented by a dashed box with a small square on its left side. A dashed line connects this box to a central octagonal connector containing three dots. From this connector, a vertical dashed line leads to a yellow-shaded box labeled <b>m730:Familiari_Type</b>. Inside this box, there are two child elements: <b>m730:PrimoModulo</b> (with a small square on its left side and a plus sign in a square on its right side) and <b>m730:Modulo</b> (with a small square on its left side, a plus sign in a square on its right side, and a <b>0..∞</b> cardinality constraint below it).</p>
<p>namespace</p>	<p>urn:www.agenziaentrate.gov.it:specificheTecniche:sco:730</p>
<p>type</p>	<p><a href="#">m730:Familiari_Type</a></p>
<p>children</p>	<p><a href="#">m730:PrimoModulo</a> <a href="#">m730:Modulo</a></p>

**element Dati\_Contabili\_Type/QuadroA**

diagram	
namespace	urn:www.agenziaentrate.gov.it:specificheTecniche:sco:730
type	<a href="#">m730:Redditi_Terreni_Type</a>
children	<a href="#">m730:Modulo</a>

**element Dati\_Contabili\_Type/QuadroB**

diagram	
namespace	urn:www.agenziaentrate.gov.it:specificheTecniche:sco:730
type	<a href="#">m730:Redditi_Fabbricati_Type</a>
children	<a href="#">m730:Modulo</a>

**element Dati\_Contabili\_Type/QuadroC**

diagram	
namespace	urn:www.agenziaentrate.gov.it:specificheTecniche:sco:730
type	<a href="#">m730:Redditi_Lavoro_Dip_Type</a>
children	<a href="#">m730:PrimoModulo</a> <a href="#">m730:Modulo</a>

**element Dati\_Contabili\_Type/QuadroD**

diagram	
---------	--

namespace	urn:www.agenziaentrate.gov.it:specificheTecniche:sco:730
type	extension of <a href="#">m730:Altri_Reddito_Type</a>
children	<a href="#">m730:Modulo</a>

**element Dati\_Contabili\_Type/QuadroE**

diagram	
namespace	urn:www.agenziaentrate.gov.it:specificheTecniche:sco:730
type	<a href="#">m730:Oneri_Type</a>
children	<a href="#">m730:PrimoModulo</a> <a href="#">m730:Modulo</a>

**element Dati\_Contabili\_Type/QuadroF**

diagram	
namespace	urn:www.agenziaentrate.gov.it:specificheTecniche:sco:730
type	<a href="#">m730:Acconti_Ritenute_Type</a>
children	<a href="#">m730:PrimoModulo</a> <a href="#">m730:Modulo</a>

**element Dati\_Contabili\_Type/QuadroG**

diagram	
namespace	urn:www.agenziaentrate.gov.it:specificheTecniche:sco:730
type	<a href="#">m730:Crediti_Imposta_Type</a>

children	<a href="#">m730:PrimoModulo</a> <a href="#">m730:Modulo</a>
----------	--

element **Dati\_Contabili\_Type/Quadrol**

diagram	
namespace	urn:www.agenziaentrate.gov.it:specificheTecniche:sco:730
type	<a href="#">m730:Quadro_I_Type</a>
children	<a href="#">m730:Importo</a> <a href="#">m730:Casella</a>

element **Dati\_Contabili\_Type/ProspettoLiquidazione**

diagram	
namespace	urn:www.agenziaentrate.gov.it:specificheTecniche:sco:730
type	<a href="#">m730:Prospetto_Liquidazione_Type</a>
children	<a href="#">m730:PrimoModulo</a> <a href="#">m730:Modulo</a>

element **Dati\_Contabili\_Type/Prospetto\_Annotazioni**

diagram	
namespace	urn:www.agenziaentrate.gov.it:specificheTecniche:sco:730
type	<a href="#">m730:Prospetto_Annotazioni_Type</a>
children	<a href="#">m730:Modulo_Annotazioni</a>

element **Dati\_Contabili\_Type/QuadroK**

diagram	
namespace	urn:www.agenziaentrate.gov.it:specificheTecniche:sco:730
type	<a href="#">m730:Comunicazione_Amministratore_Type</a>
children	<a href="#">m730:Modulo</a>

complexType **Dati\_Contratto\_Type**

diagram	
namespace	urn:www.agenziaentrate.gov.it:specificheTecniche:sco:730
children	<a href="#">m730:DataRegContratto</a> <a href="#">m730:SerieContratto</a> <a href="#">m730:NumeroContratto</a> <a href="#">m730:Sottonumero</a> <a href="#">m730:CodiceUfficio</a> <a href="#">m730:IdentificativoContratto</a>

element **Dati\_Contratto\_Type/DataRegContratto**

diagram					
namespace	urn:www.agenziaentrate.gov.it:specificheTecniche:sco:730				
type	<a href="#">DatoDT_Type</a>				
facets	<table border="1"> <thead> <tr> <th>Kind</th> <th>Value</th> </tr> </thead> <tbody> <tr> <td>pattern</td> <td>((([0-9]{1,12} [0-9]{3,10} 0[13578]1012\d{4})) ([0-9]{1,12} [0-9]{3,10} 0[469]11\d{4})) ([0-9]{1,12} [0-9]{2,8} 02\d{4})) ((29)(02)([02468][048]00)) ((29)(02)([13579][26]00)) ((29)(02)([0-9][0-9][048])) ((29)(02)([0-9][0-9][2468][048])) ((29)(02)([0-9][0-9][13579][26]))))</td> </tr> </tbody> </table>	Kind	Value	pattern	((([0-9]{1,12} [0-9]{3,10} 0[13578]1012\d{4})) ([0-9]{1,12} [0-9]{3,10} 0[469]11\d{4})) ([0-9]{1,12} [0-9]{2,8} 02\d{4})) ((29)(02)([02468][048]00)) ((29)(02)([13579][26]00)) ((29)(02)([0-9][0-9][048])) ((29)(02)([0-9][0-9][2468][048])) ((29)(02)([0-9][0-9][13579][26]))))
Kind	Value				
pattern	((([0-9]{1,12} [0-9]{3,10} 0[13578]1012\d{4})) ([0-9]{1,12} [0-9]{3,10} 0[469]11\d{4})) ([0-9]{1,12} [0-9]{2,8} 02\d{4})) ((29)(02)([02468][048]00)) ((29)(02)([13579][26]00)) ((29)(02)([0-9][0-9][048])) ((29)(02)([0-9][0-9][2468][048])) ((29)(02)([0-9][0-9][13579][26]))))				

element **Dati\_Contratto\_Type/SerieContratto**

diagram	
namespace	urn:www.agenziaentrate.gov.it:specificheTecniche:sco:730



type	<a href="#">m730:Serie Registrazione Contratto Type</a>	
facets	Kind	Value
	pattern	(([0-9A-Z\-\]]&quot;){1}([ 0-9A-Z&amp;:] [\-\.\, /°\^\(\)\]À È É Ì Ò Ù Û &quot; \N \+)*
	enumeration	3
	enumeration	3A
	enumeration	3B
	enumeration	3P
	enumeration	1T
	enumeration	3T

#### element **Dati\_Contratto\_Type/NumeroContratto**

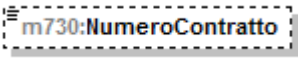
diagram		
namespace	urn:www.agenziaentrate.gov.it:specificheTecniche:sco:730	
type	<a href="#">DatoAN Type</a>	
facets	Kind	Value
	pattern	(([0-9A-Z\-\]]&quot;){1}([ 0-9A-Z&amp;:] [\-\.\, /°\^\(\)\]À È É Ì Ò Ù Û &quot; \N \+)*

#### element **Dati\_Contratto\_Type/Sottonumero**

diagram		
namespace	urn:www.agenziaentrate.gov.it:specificheTecniche:sco:730	
type	<a href="#">DatoAN Type</a>	
facets	Kind	Value
	pattern	(([0-9A-Z\-\]]&quot;){1}([ 0-9A-Z&amp;:] [\-\.\, /°\^\(\)\]À È É Ì Ò Ù Û &quot; \N \+)*

#### element **Dati\_Contratto\_Type/CodiceUfficio**

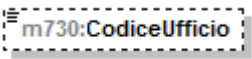
diagram		
namespace	urn:www.agenziaentrate.gov.it:specificheTecniche:sco:730	
type	restriction of <a href="#">DatoAN Type</a>	
facets	Kind	Value
	pattern	(([0-9A-Z\-\]]&quot;){1}([ 0-9A-Z&amp;:] [\-\.\, /°\^\(\)\]À È É Ì Ò Ù Û &quot; \N \+)*

#### element **Dati\_Contratto\_Type/IdentificativoContratto**

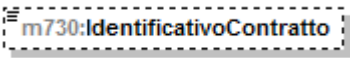
diagram		
namespace	urn:www.agenziaentrate.gov.it:specificheTecniche:sco:730	
type	<a href="#">DatoAN Type</a>	
facets	Kind	Value
	pattern	(([0-9A-Z\-\]]&quot;){1}([ 0-9A-Z&amp;:] [\-\.\, /°\^\(\)\]À È É Ì Ò Ù Û &quot; \N \+)*

complexType **Dati\_Familiare\_Type**

diagram	
namespace	urn:www.agenziaentrate.gov.it:specificheTecniche:sco:730
children	<a href="#">m730:CodiceFiscale</a> <a href="#">m730:Mesi</a> <a href="#">m730:MesiMinore</a> <a href="#">m730:PercDetraz</a> <a href="#">m730:PercDetrazCon</a> <a href="#">m730:Affidamento</a>

element **Dati\_Familiare\_Type/CodiceFiscale**

diagram					
namespace	urn:www.agenziaentrate.gov.it:specificheTecniche:sco:730				
type	<a href="#">DatoCF_Type</a>				
facets	<table border="1"> <tr> <th>Kind</th> <th>Value</th> </tr> <tr> <td>pattern</td> <td>[0-9]{11}[A-Z]{6}[0-9LMNPQRSTUUV]{2}[A-Z]{1}[0-9LMNPQRSTUUV]{2}[A-Z]{1}[0-9LMNPQRSTUUV]{3}[A-Z]{1}</td> </tr> </table>	Kind	Value	pattern	[0-9]{11}[A-Z]{6}[0-9LMNPQRSTUUV]{2}[A-Z]{1}[0-9LMNPQRSTUUV]{2}[A-Z]{1}[0-9LMNPQRSTUUV]{3}[A-Z]{1}
Kind	Value				
pattern	[0-9]{11}[A-Z]{6}[0-9LMNPQRSTUUV]{2}[A-Z]{1}[0-9LMNPQRSTUUV]{2}[A-Z]{1}[0-9LMNPQRSTUUV]{3}[A-Z]{1}				

element **Dati\_Familiare\_Type/Mesi**

diagram					
namespace	urn:www.agenziaentrate.gov.it:specificheTecniche:sco:730				
type	<a href="#">DatoNP_Type</a>				
facets	<table border="1"> <tr> <th>Kind</th> <th>Value</th> </tr> <tr> <td>pattern</td> <td>[1-9]{1}[0-9]*</td> </tr> </table>	Kind	Value	pattern	[1-9]{1}[0-9]*
Kind	Value				
pattern	[1-9]{1}[0-9]*				

element **Dati\_Familiare\_Type/MesiMinore**

diagram					
namespace	urn:www.agenziaentrate.gov.it:specificheTecniche:sco:730				
type	<a href="#">DatoNP_Type</a>				
facets	<table border="1"> <tr> <th>Kind</th> <th>Value</th> </tr> <tr> <td>pattern</td> <td>[1-9]{1}[0-9]*</td> </tr> </table>	Kind	Value	pattern	[1-9]{1}[0-9]*
Kind	Value				
pattern	[1-9]{1}[0-9]*				

element **Dati\_Familiare\_Type/PercDetraz**

diagram					
namespace	urn:www.agenziaentrate.gov.it:specificheTecniche:sco:730				
type	<a href="#">DatoPC_Type</a>				
facets	<table border="1"> <tr> <td>Kind</td> <td>Value</td> </tr> <tr> <td>pattern</td> <td>[0-9]?[0-9](, d{1,3})? 100,0{1,3}?</td> </tr> </table>	Kind	Value	pattern	[0-9]?[0-9](, d{1,3})? 100,0{1,3}?
Kind	Value				
pattern	[0-9]?[0-9](, d{1,3})? 100,0{1,3}?				

element **Dati\_Familiare\_Type/PercDetrazCon**

diagram					
namespace	urn:www.agenziaentrate.gov.it:specificheTecniche:sco:730				
type	<a href="#">DatoAN_Type</a>				
facets	<table border="1"> <tr> <td>Kind</td> <td>Value</td> </tr> <tr> <td>pattern</td> <td>([0-9A-Z\-\ ]&amp;quot;){1}([ 0-9A-Z&amp;amp;#92; \\- \\. , / ^\\v\\(\\) À É È Ì Ò Ù Û &amp;quot;; \\ \\ \\+)*</td> </tr> </table>	Kind	Value	pattern	([0-9A-Z\-\ ]&quot;){1}([ 0-9A-Z&amp;#92; \\- \\. , / ^\\v\\(\\) À É È Ì Ò Ù Û &quot;; \\ \\ \\+)*
Kind	Value				
pattern	([0-9A-Z\-\ ]&quot;){1}([ 0-9A-Z&amp;#92; \\- \\. , / ^\\v\\(\\) À É È Ì Ò Ù Û &quot;; \\ \\ \\+)*				

element **Dati\_Familiare\_Type/Affidamento**

diagram					
namespace	urn:www.agenziaentrate.gov.it:specificheTecniche:sco:730				
type	<a href="#">DatoCB_Type</a>				
facets	<table border="1"> <tr> <td>Kind</td> <td>Value</td> </tr> <tr> <td>pattern</td> <td>[01]</td> </tr> </table>	Kind	Value	pattern	[01]
Kind	Value				
pattern	[01]				

complexType **Dati\_Fornitore\_Type**

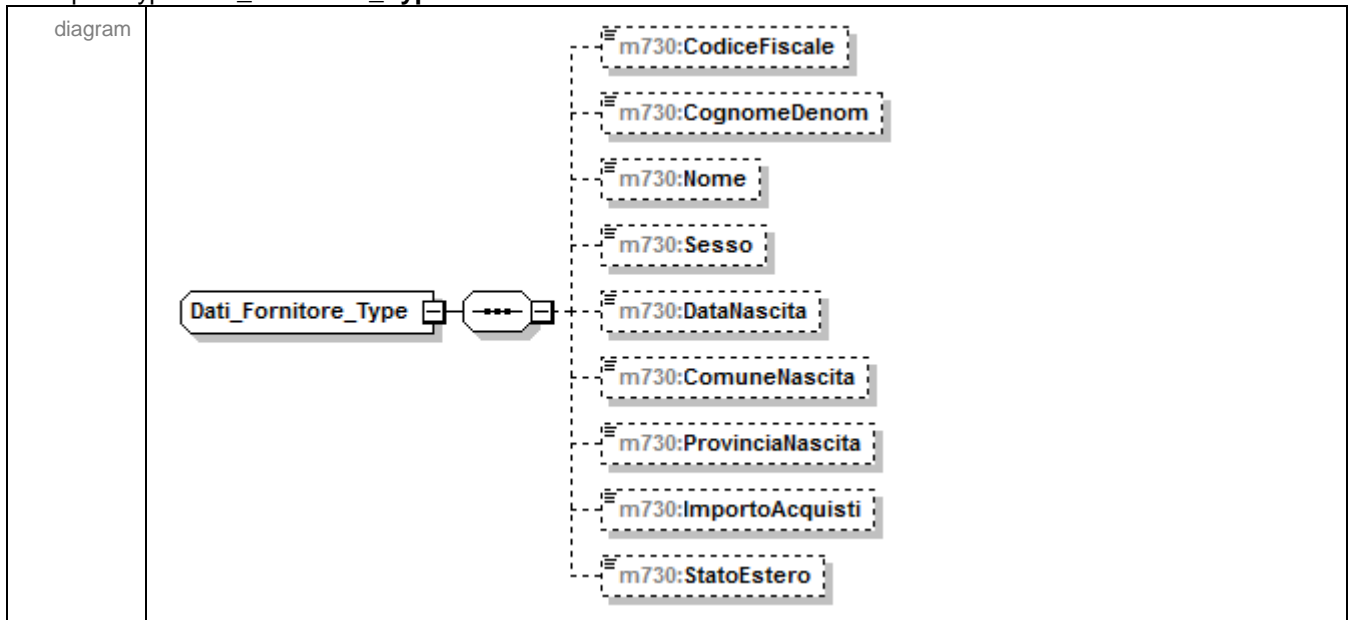

namespace	urn:www.agenziaentrate.gov.it:specificheTecniche:sco:730
children	<a href="#">m730:CodiceFiscale</a> <a href="#">m730:CognomeDenom</a> <a href="#">m730:Nome</a> <a href="#">m730:Sesso</a> <a href="#">m730:DataNascita</a> <a href="#">m730:ComuneNascita</a> <a href="#">m730:ProvinciaNascita</a> <a href="#">m730:ImportoAcquisti</a> <a href="#">m730:StatoEstero</a>

#### element Dati\_Fornitore\_Type/CodiceFiscale

diagram					
namespace	urn:www.agenziaentrate.gov.it:specificheTecniche:sco:730				
type	<a href="#">DatoCF_Type</a>				
facets	<table border="1"> <tr> <td>Kind</td> <td>Value</td> </tr> <tr> <td>pattern</td> <td>[0-9]{11}[A-Z]{6}[0-9LMNPQRSTU]{2}[A-Z]{1}[0-9LMNPQRSTU]{2}[A-Z]{1}[0-9LMNPQRSTU]{3}[A-Z]{1}</td> </tr> </table>	Kind	Value	pattern	[0-9]{11}[A-Z]{6}[0-9LMNPQRSTU]{2}[A-Z]{1}[0-9LMNPQRSTU]{2}[A-Z]{1}[0-9LMNPQRSTU]{3}[A-Z]{1}
Kind	Value				
pattern	[0-9]{11}[A-Z]{6}[0-9LMNPQRSTU]{2}[A-Z]{1}[0-9LMNPQRSTU]{2}[A-Z]{1}[0-9LMNPQRSTU]{3}[A-Z]{1}				

#### element Dati\_Fornitore\_Type/CognomeDenom

diagram					
namespace	urn:www.agenziaentrate.gov.it:specificheTecniche:sco:730				
type	<a href="#">DatoAN_Type</a>				
facets	<table border="1"> <tr> <td>Kind</td> <td>Value</td> </tr> <tr> <td>pattern</td> <td>([0-9A-Z-] \&amp;quot;){1}([ 0-9A-Z&amp;amp;#39; ' \"- _ . / ° \"^\\(\\) À È É Ì Ò Ù Û &amp;quot; \\ \\ \\ +)*</td> </tr> </table>	Kind	Value	pattern	([0-9A-Z-] \&quot;){1}([ 0-9A-Z&amp;#39; ' \"- _ . / ° \"^\\(\\) À È É Ì Ò Ù Û &quot; \\ \\ \\ +)*
Kind	Value				
pattern	([0-9A-Z-] \&quot;){1}([ 0-9A-Z&amp;#39; ' \"- _ . / ° \"^\\(\\) À È É Ì Ò Ù Û &quot; \\ \\ \\ +)*				

#### element Dati\_Fornitore\_Type/Nome

diagram					
namespace	urn:www.agenziaentrate.gov.it:specificheTecniche:sco:730				
type	<a href="#">DatoAN_Type</a>				
facets	<table border="1"> <tr> <td>Kind</td> <td>Value</td> </tr> <tr> <td>pattern</td> <td>([0-9A-Z-] \&amp;quot;){1}([ 0-9A-Z&amp;amp;#39; ' \"- _ . / ° \"^\\(\\) À È É Ì Ò Ù Û &amp;quot; \\ \\ \\ +)*</td> </tr> </table>	Kind	Value	pattern	([0-9A-Z-] \&quot;){1}([ 0-9A-Z&amp;#39; ' \"- _ . / ° \"^\\(\\) À È É Ì Ò Ù Û &quot; \\ \\ \\ +)*
Kind	Value				
pattern	([0-9A-Z-] \&quot;){1}([ 0-9A-Z&amp;#39; ' \"- _ . / ° \"^\\(\\) À È É Ì Ò Ù Û &quot; \\ \\ \\ +)*				

#### element Dati\_Fornitore\_Type/Sesso

diagram									
namespace	urn:www.agenziaentrate.gov.it:specificheTecniche:sco:730								
type	<a href="#">Sesso_Type</a>								
facets	<table border="1"> <tr> <td>Kind</td> <td>Value</td> </tr> <tr> <td>pattern</td> <td>([0-9A-Z-] \&amp;quot;){1}([ 0-9A-Z&amp;amp;#39; ' \"- _ . / ° \"^\\(\\) À È É Ì Ò Ù Û &amp;quot; \\ \\ \\ +)*</td> </tr> <tr> <td>enumeration</td> <td>M</td> </tr> <tr> <td>enumeration</td> <td>F</td> </tr> </table>	Kind	Value	pattern	([0-9A-Z-] \&quot;){1}([ 0-9A-Z&amp;#39; ' \"- _ . / ° \"^\\(\\) À È É Ì Ò Ù Û &quot; \\ \\ \\ +)*	enumeration	M	enumeration	F
Kind	Value								
pattern	([0-9A-Z-] \&quot;){1}([ 0-9A-Z&amp;#39; ' \"- _ . / ° \"^\\(\\) À È É Ì Ò Ù Û &quot; \\ \\ \\ +)*								
enumeration	M								
enumeration	F								

element **Dati\_Fornitore\_Type/DataNascita**

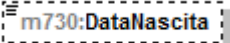
diagram					
namespace	urn:www.agenziaentrate.gov.it:specificheTecniche:sco:730				
type	<a href="#">DatoDT_Type</a>				
facets	<table border="1"> <tr> <td>Kind</td> <td>Value</td> </tr> <tr> <td>pattern</td> <td>((([0-9]{1,2}[0-9]{3,4} 0[13578]10 12)\d{4}) ([0-9]{1,2}[0-9]{3,4} 0[469]11)\d{4}) ([0-9]{1,2}[0-9]{2}[0-8])(02\d{4}) ((29)(02)[02468][048]00) ((29)(02)[13579][26]00) ((29)(02)[0-9][0-9][0][48]) ((29)(02)[0-9][0-9][2468][048]) ((29)(02)[0-9][0-9][13579][26]))</td> </tr> </table>	Kind	Value	pattern	((([0-9]{1,2}[0-9]{3,4} 0[13578]10 12)\d{4}) ([0-9]{1,2}[0-9]{3,4} 0[469]11)\d{4}) ([0-9]{1,2}[0-9]{2}[0-8])(02\d{4}) ((29)(02)[02468][048]00) ((29)(02)[13579][26]00) ((29)(02)[0-9][0-9][0][48]) ((29)(02)[0-9][0-9][2468][048]) ((29)(02)[0-9][0-9][13579][26]))
Kind	Value				
pattern	((([0-9]{1,2}[0-9]{3,4} 0[13578]10 12)\d{4}) ([0-9]{1,2}[0-9]{3,4} 0[469]11)\d{4}) ([0-9]{1,2}[0-9]{2}[0-8])(02\d{4}) ((29)(02)[02468][048]00) ((29)(02)[13579][26]00) ((29)(02)[0-9][0-9][0][48]) ((29)(02)[0-9][0-9][2468][048]) ((29)(02)[0-9][0-9][13579][26]))				

element **Dati\_Fornitore\_Type/ComuneNascita**

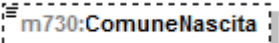
diagram					
namespace	urn:www.agenziaentrate.gov.it:specificheTecniche:sco:730				
type	<a href="#">DatoAN_Type</a>				
facets	<table border="1"> <tr> <td>Kind</td> <td>Value</td> </tr> <tr> <td>pattern</td> <td>([0-9A-Z-] \&amp;quot;){1}([ 0-9A-Z&amp;amp;] ' \" _ . / ° °\ (\ )À È É Ì Ò Ù Ú Û&amp;quot; \ \\ /+)*</td> </tr> </table>	Kind	Value	pattern	([0-9A-Z-] \&quot;){1}([ 0-9A-Z&amp;] ' \" _ . / ° °\ (\ )À È É Ì Ò Ù Ú Û&quot; \ \\ /+)*
Kind	Value				
pattern	([0-9A-Z-] \&quot;){1}([ 0-9A-Z&amp;] ' \" _ . / ° °\ (\ )À È É Ì Ò Ù Ú Û&quot; \ \\ /+)*				

element **Dati\_Fornitore\_Type/ProvinciaNascita**

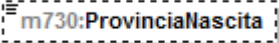
diagram	
namespace	urn:www.agenziaentrate.gov.it:specificheTecniche:sco:730
type	<a href="#">PN_Type</a>

element **Dati\_Fornitore\_Type/ImportoAcquisti**

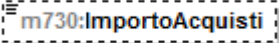
diagram					
namespace	urn:www.agenziaentrate.gov.it:specificheTecniche:sco:730				
type	<a href="#">DatoNP_Type</a>				
facets	<table border="1"> <tr> <td>Kind</td> <td>Value</td> </tr> <tr> <td>pattern</td> <td>[1-9]{1}[0-9]*</td> </tr> </table>	Kind	Value	pattern	[1-9]{1}[0-9]*
Kind	Value				
pattern	[1-9]{1}[0-9]*				

element **Dati\_Fornitore\_Type/StatoEstero**

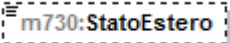
diagram					
namespace	urn:www.agenziaentrate.gov.it:specificheTecniche:sco:730				
type	<a href="#">DatoAN_Type</a>				
facets	<table border="1"> <tr> <td>Kind</td> <td>Value</td> </tr> <tr> <td>pattern</td> <td>([0-9A-Z-] \&amp;quot;){1}([ 0-9A-Z&amp;amp;] ' \" _ . / ° °\ (\ )À È É Ì Ò Ù Ú Û&amp;quot; \ \\ /+)*</td> </tr> </table>	Kind	Value	pattern	([0-9A-Z-] \&quot;){1}([ 0-9A-Z&amp;] ' \" _ . / ° °\ (\ )À È É Ì Ò Ù Ú Û&quot; \ \\ /+)*
Kind	Value				
pattern	([0-9A-Z-] \&quot;){1}([ 0-9A-Z&amp;] ' \" _ . / ° °\ (\ )À È É Ì Ò Ù Ú Û&quot; \ \\ /+)*				

complexType **Dati\_Nascita\_PF\_Type**

diagram	
namespace	urn:www.agenziaentrate.gov.it:specificheTecniche:sco:730
children	<a href="#">m730:Sesso</a> <a href="#">m730:DataNascita</a> <a href="#">m730:ComuneNascita</a> <a href="#">m730:ProvinciaNascita</a>

element **Dati\_Nascita\_PF\_Type/Sesso**

diagram									
namespace	urn:www.agenziaentrate.gov.it:specificheTecniche:sco:730								
type	<a href="#">Sesso_Type</a>								
facets	<table border="0"> <tr> <td>Kind</td> <td>Value</td> </tr> <tr> <td>pattern</td> <td>(([0-9A-Z-] &amp;quot;){1}([ 0-9A-Z&amp;amp;] ' - \., / ° °\^\(\ )\ À È É Ì Ò Ù Ü &amp;quot;; \\ / +)*</td> </tr> <tr> <td>enumeration</td> <td>M</td> </tr> <tr> <td>enumeration</td> <td>F</td> </tr> </table>	Kind	Value	pattern	(([0-9A-Z-] &quot;){1}([ 0-9A-Z&amp;] ' - \., / ° °\^\(\ )\ À È É Ì Ò Ù Ü &quot;; \\ / +)*	enumeration	M	enumeration	F
Kind	Value								
pattern	(([0-9A-Z-] &quot;){1}([ 0-9A-Z&amp;] ' - \., / ° °\^\(\ )\ À È É Ì Ò Ù Ü &quot;; \\ / +)*								
enumeration	M								
enumeration	F								

element **Dati\_Nascita\_PF\_Type/DataNascita**

diagram					
namespace	urn:www.agenziaentrate.gov.it:specificheTecniche:sco:730				
type	<a href="#">DatoDT_Type</a>				
facets	<table border="0"> <tr> <td>Kind</td> <td>Value</td> </tr> <tr> <td>pattern</td> <td>((([0-9]{12}[0-9]{3}[01])(0[13578][10]12)\d{4})) ((([0-9]{12}[0-9]{30})(0[469][11]\d{4})) ((0[1-9][1[0-9]]2[0-8])(02)\d{4})) ((29)(02)([02468][048]00)) ((29)(02)([13579][26]00)) ((29)(02)([0-9][0-9][0][48])) ((29)(02)([0-9][0-9][2468][048])) ((29)(02)([0-9][0-9][13579][26]))</td> </tr> </table>	Kind	Value	pattern	((([0-9]{12}[0-9]{3}[01])(0[13578][10]12)\d{4})) ((([0-9]{12}[0-9]{30})(0[469][11]\d{4})) ((0[1-9][1[0-9]]2[0-8])(02)\d{4})) ((29)(02)([02468][048]00)) ((29)(02)([13579][26]00)) ((29)(02)([0-9][0-9][0][48])) ((29)(02)([0-9][0-9][2468][048])) ((29)(02)([0-9][0-9][13579][26]))
Kind	Value				
pattern	((([0-9]{12}[0-9]{3}[01])(0[13578][10]12)\d{4})) ((([0-9]{12}[0-9]{30})(0[469][11]\d{4})) ((0[1-9][1[0-9]]2[0-8])(02)\d{4})) ((29)(02)([02468][048]00)) ((29)(02)([13579][26]00)) ((29)(02)([0-9][0-9][0][48])) ((29)(02)([0-9][0-9][2468][048])) ((29)(02)([0-9][0-9][13579][26]))				

element **Dati\_Nascita\_PF\_Type/ComuneNascita**

diagram					
namespace	urn:www.agenziaentrate.gov.it:specificheTecniche:sco:730				
type	<a href="#">DatoAN_Type</a>				
facets	<table border="0"> <tr> <td>Kind</td> <td>Value</td> </tr> <tr> <td>pattern</td> <td>(([0-9A-Z-] &amp;quot;){1}([ 0-9A-Z&amp;amp;] ' - \., / ° °\^\(\ )\ À È É Ì Ò Ù Ü &amp;quot;; \\ / +)*</td> </tr> </table>	Kind	Value	pattern	(([0-9A-Z-] &quot;){1}([ 0-9A-Z&amp;] ' - \., / ° °\^\(\ )\ À È É Ì Ò Ù Ü &quot;; \\ / +)*
Kind	Value				
pattern	(([0-9A-Z-] &quot;){1}([ 0-9A-Z&amp;] ' - \., / ° °\^\(\ )\ À È É Ì Ò Ù Ü &quot;; \\ / +)*				

element **Dati\_Nascita\_PF\_Type/ProvinciaNascita**

diagram	
namespace	urn:www.agenziaentrate.gov.it:specificheTecniche:sco:730
type	<a href="#">PN_Type</a>

complexType **Dati\_Primo\_Figlio\_Type**

diagram	
namespace	urn:www.agenziaentrate.gov.it:specificheTecniche:sco:730
children	<a href="#">m730:Tipo</a> <a href="#">m730:CodiceFiscale</a> <a href="#">m730:Mesi</a> <a href="#">m730:MesiMinore</a> <a href="#">m730:PercDetraz</a> <a href="#">m730:Affidamento</a>

element **Dati\_Primo\_Figlio\_Type/Tipo**

diagram									
namespace	urn:www.agenziaentrate.gov.it:specificheTecniche:sco:730								
type	restriction of <a href="#">DatoAN_Type</a>								
facets	<table border="0"> <tr> <td>Kind</td> <td>Value</td> </tr> <tr> <td>pattern</td> <td>(([0-9A-Z-])&amp;quot;){1}([ 0-9A-Z&amp;amp;:] ' - .!, / ^\v\(\ \)À È É Ì Ò Ù Û &amp;quot; \ \\ \ +)*</td> </tr> <tr> <td>enumeration</td> <td>F</td> </tr> <tr> <td>enumeration</td> <td>D</td> </tr> </table>	Kind	Value	pattern	(([0-9A-Z-])&quot;){1}([ 0-9A-Z&amp;:] ' - .!, / ^\v\(\ \)À È É Ì Ò Ù Û &quot; \ \\ \ +)*	enumeration	F	enumeration	D
Kind	Value								
pattern	(([0-9A-Z-])&quot;){1}([ 0-9A-Z&amp;:] ' - .!, / ^\v\(\ \)À È É Ì Ò Ù Û &quot; \ \\ \ +)*								
enumeration	F								
enumeration	D								

element **Dati\_Primo\_Figlio\_Type/CodiceFiscale**

diagram					
namespace	urn:www.agenziaentrate.gov.it:specificheTecniche:sco:730				
type	<a href="#">DatoCF_Type</a>				
facets	<table border="0"> <tr> <td>Kind</td> <td>Value</td> </tr> <tr> <td>pattern</td> <td>[0-9]{11}[A-Z]{6}[0-9LMNPQRSTUVWXYZ]{2}[A-Z]{1}[0-9LMNPQRSTUVWXYZ]{2}[A-Z]{1}[0-9LMNPQRSTUVWXYZ]{3}[A-Z]{1}</td> </tr> </table>	Kind	Value	pattern	[0-9]{11}[A-Z]{6}[0-9LMNPQRSTUVWXYZ]{2}[A-Z]{1}[0-9LMNPQRSTUVWXYZ]{2}[A-Z]{1}[0-9LMNPQRSTUVWXYZ]{3}[A-Z]{1}
Kind	Value				
pattern	[0-9]{11}[A-Z]{6}[0-9LMNPQRSTUVWXYZ]{2}[A-Z]{1}[0-9LMNPQRSTUVWXYZ]{2}[A-Z]{1}[0-9LMNPQRSTUVWXYZ]{3}[A-Z]{1}				

element **Dati\_Primo\_Figlio\_Type/Mesi**

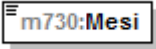
diagram																													
namespace	urn:www.agenziaentrate.gov.it:specificheTecniche:sco:730																												
type	<a href="#">m730:Mesi_Type</a>																												
facets	<table border="1"> <thead> <tr> <th>Kind</th> <th>Value</th> </tr> </thead> <tbody> <tr> <td>pattern</td> <td>[1-9]{1}[0-9]*</td> </tr> <tr> <td>enumeration</td> <td>1</td> </tr> <tr> <td>enumeration</td> <td>2</td> </tr> <tr> <td>enumeration</td> <td>3</td> </tr> <tr> <td>enumeration</td> <td>4</td> </tr> <tr> <td>enumeration</td> <td>5</td> </tr> <tr> <td>enumeration</td> <td>6</td> </tr> <tr> <td>enumeration</td> <td>7</td> </tr> <tr> <td>enumeration</td> <td>8</td> </tr> <tr> <td>enumeration</td> <td>9</td> </tr> <tr> <td>enumeration</td> <td>10</td> </tr> <tr> <td>enumeration</td> <td>11</td> </tr> <tr> <td>enumeration</td> <td>12</td> </tr> </tbody> </table>	Kind	Value	pattern	[1-9]{1}[0-9]*	enumeration	1	enumeration	2	enumeration	3	enumeration	4	enumeration	5	enumeration	6	enumeration	7	enumeration	8	enumeration	9	enumeration	10	enumeration	11	enumeration	12
Kind	Value																												
pattern	[1-9]{1}[0-9]*																												
enumeration	1																												
enumeration	2																												
enumeration	3																												
enumeration	4																												
enumeration	5																												
enumeration	6																												
enumeration	7																												
enumeration	8																												
enumeration	9																												
enumeration	10																												
enumeration	11																												
enumeration	12																												

element **Dati\_Primo\_Figlio\_Type/MesiMinore**

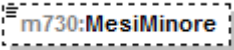
diagram																													
namespace	urn:www.agenziaentrate.gov.it:specificheTecniche:sco:730																												
type	<a href="#">m730:Mesi_Type</a>																												
facets	<table border="1"> <thead> <tr> <th>Kind</th> <th>Value</th> </tr> </thead> <tbody> <tr> <td>pattern</td> <td>[1-9]{1}[0-9]*</td> </tr> <tr> <td>enumeration</td> <td>1</td> </tr> <tr> <td>enumeration</td> <td>2</td> </tr> <tr> <td>enumeration</td> <td>3</td> </tr> <tr> <td>enumeration</td> <td>4</td> </tr> <tr> <td>enumeration</td> <td>5</td> </tr> <tr> <td>enumeration</td> <td>6</td> </tr> <tr> <td>enumeration</td> <td>7</td> </tr> <tr> <td>enumeration</td> <td>8</td> </tr> <tr> <td>enumeration</td> <td>9</td> </tr> <tr> <td>enumeration</td> <td>10</td> </tr> <tr> <td>enumeration</td> <td>11</td> </tr> <tr> <td>enumeration</td> <td>12</td> </tr> </tbody> </table>	Kind	Value	pattern	[1-9]{1}[0-9]*	enumeration	1	enumeration	2	enumeration	3	enumeration	4	enumeration	5	enumeration	6	enumeration	7	enumeration	8	enumeration	9	enumeration	10	enumeration	11	enumeration	12
Kind	Value																												
pattern	[1-9]{1}[0-9]*																												
enumeration	1																												
enumeration	2																												
enumeration	3																												
enumeration	4																												
enumeration	5																												
enumeration	6																												
enumeration	7																												
enumeration	8																												
enumeration	9																												
enumeration	10																												
enumeration	11																												
enumeration	12																												

element **Dati\_Primo\_Figlio\_Type/PercDetraz**

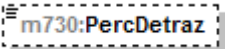
diagram					
namespace	urn:www.agenziaentrate.gov.it:specificheTecniche:sco:730				
type	<a href="#">DatoPC_Type</a>				
facets	<table border="1"> <thead> <tr> <th>Kind</th> <th>Value</th> </tr> </thead> <tbody> <tr> <td>pattern</td> <td>[0-9]?[0-9](,\d{1,3})? 100,(0{1,3})?</td> </tr> </tbody> </table>	Kind	Value	pattern	[0-9]?[0-9](,\d{1,3})? 100,(0{1,3})?
Kind	Value				
pattern	[0-9]?[0-9](,\d{1,3})? 100,(0{1,3})?				



element **Dati\_Primo\_Figlio\_Type/Affidamento**

diagram	
namespace	urn:www.agenziaentrate.gov.it:specificheTecniche:sco:730
type	<a href="#">DatoCB_Type</a>
facets	Kind Value pattern [01]

complexType **Dati\_Professionista\_Type**

diagram	
namespace	urn:www.agenziaentrate.gov.it:specificheTecniche:sco:730
children	<a href="#">m730:CFProfessionista</a> <a href="#">m730:CognomeProfessionista</a> <a href="#">m730:NomeProfessionista</a>

element **Dati\_Professionista\_Type/CFProfessionista**

diagram	
namespace	urn:www.agenziaentrate.gov.it:specificheTecniche:sco:730
type	<a href="#">DatoCF_Type</a>
facets	Kind Value pattern [0-9]{11}[[A-Z]{6}[0-9LMNPQRSTUUV]{2}[[A-Z]{1}[0-9LMNPQRSTUUV]{2}[[A-Z]{1}[0-9LMNPQRSTUUV]{3}[[A-Z]{1}]

element **Dati\_Professionista\_Type/CognomeProfessionista**

diagram	
namespace	urn:www.agenziaentrate.gov.it:specificheTecniche:sco:730
type	<a href="#">DatoAN_Type</a>
facets	Kind Value pattern (([0-9A-Z-] \&quot;){1}([ 0-9A-Z&amp;#39; ! - \., / ^*\(\)\ À É È Ì Ò Ù Û &quot; \ \\ / +)*

element **Dati\_Professionista\_Type/NomeProfessionista**

diagram	
namespace	urn:www.agenziaentrate.gov.it:specificheTecniche:sco:730
type	<a href="#">DatoAN_Type</a>

facets	Kind	Value
	pattern	([0-9A-Z-] \&quot;){1}([ 0-9A-Z&amp;:] ' \" . , / ° ^\(\\ \\) À É È Ì Ò Ù Ú &quot; \\ \\ \\ +)*

**complexType Dati\_Registrazione\_Accatastamento\_Recupero\_Patrimonio\_Edilizio\_Type**

diagram	
namespace	urn:www.agenziaentrate.gov.it:specificheTecniche:sco:730
children	<a href="#">m730:NOrdImmobile</a> <a href="#">m730:Condominio</a> <a href="#">m730:EstremiRegistrazioneContratto</a> <a href="#">m730:DomandaAccatastamento</a>

**element Dati\_Registrazione\_Accatastamento\_Recupero\_Patrimonio\_Edilizio\_Type/NOrdImmobile**

diagram	
namespace	urn:www.agenziaentrate.gov.it:specificheTecniche:sco:730
type	<a href="#">DatoNP_Type</a>
facets	Kind Value pattern [1-9]{1}[0-9]*

**element Dati\_Registrazione\_Accatastamento\_Recupero\_Patrimonio\_Edilizio\_Type/Condominio**

diagram	
namespace	urn:www.agenziaentrate.gov.it:specificheTecniche:sco:730
type	<a href="#">DatoCB_Type</a>
facets	Kind Value pattern [01]

element

**Dati\_Registrazione\_Accatastamento\_Recupero\_Patrimonio\_Edilizio\_Type/EstremiRegistrazioneContra**  
**tto**

diagram	<p>The diagram shows a dashed box labeled 'm730:EstremiRegistrazioneCo...' connected to a central connector box. This connector is linked to a larger dashed box labeled 'm730:Dati_Contratto_Type'. Inside this box, six child elements are listed: m730:DataRegContratto, m730:SerieContratto, m730:NumeroContratto, m730:Sottonumero, m730:CodiceUfficio, and m730:IdentificativoContratto.</p>
namespace	urn:www.agenziaentrate.gov.it:specificheTecniche:sco:730
type	<a href="#">m730:Dati_Contratto_Type</a>
children	<a href="#">m730:DataRegContratto</a> <a href="#">m730:SerieContratto</a> <a href="#">m730:NumeroContratto</a> <a href="#">m730:Sottonumero</a> <a href="#">m730:CodiceUfficio</a> <a href="#">m730:IdentificativoContratto</a>

element

**Dati\_Registrazione\_Accatastamento\_Recupero\_Patrimonio\_Edilizio\_Type/DomandaAccatastamento**

diagram	<p>The diagram shows a dashed box labeled 'm730:DomandaAccatastamento' connected to a central connector box. This connector is linked to a larger dashed box labeled 'm730:Domanda_Accatastamento_Type'. Inside this box, three child elements are listed: m730:Data, m730:Numero, and m730:ProvinciaUfficio.</p>
namespace	urn:www.agenziaentrate.gov.it:specificheTecniche:sco:730
type	<a href="#">m730:Domanda_Accatastamento_Type</a>
children	<a href="#">m730:Data</a> <a href="#">m730:Numero</a> <a href="#">m730:ProvinciaUfficio</a>

**complexType Dati\_Rettificati\_Type**

diagram	<p>The diagram shows a dashed box labeled 'Dati_Rettificati_Type' connected to a central connector box. This connector is linked to a dashed box labeled 'm730:Modulo'. Below the 'm730:Modulo' box, the cardinality '1..∞' is indicated.</p>
namespace	urn:www.agenziaentrate.gov.it:specificheTecniche:sco:730
children	<a href="#">m730:Modulo</a>

element **Dati\_Rettificati\_Type/Modulo**

diagram	
namespace	urn:www.agenziaentrate.gov.it:specificheTecniche:sco:730
type	<a href="#">m730:Modulo_Dati_Rettificati_Type</a>
children	<a href="#">m730:Rettifica</a>

complexType **Modulo\_Dati\_Rettificati\_Type**

diagram	
namespace	urn:www.agenziaentrate.gov.it:specificheTecniche:sco:730
children	<a href="#">m730:Rettifica</a>

element **Dati\_Rettificati\_Type/Rettifica**

diagram	
namespace	urn:www.agenziaentrate.gov.it:specificheTecniche:sco:730
type	<a href="#">m730:Rettifica_Type</a>
children	<a href="#">m730:Quadro</a> <a href="#">m730:Rigo</a> <a href="#">m730:Colonna</a> <a href="#">m730:Modulo</a> <a href="#">m730:DatoRimosso</a>

complexType **Debito\_Type**

diagram	
namespace	urn:www.agenziaentrate.gov.it:specificheTecniche:sco:730
children	<a href="#">m730:NonVersare</a> <a href="#">m730:ImportoDaTrattenere</a>

**element Debito\_Type/NonVersare**

diagram	
namespace	urn:www.agenziaentrate.gov.it:specificheTecniche:sco:730
type	<a href="#">DatoNP_Type</a>
facets	Kind Value pattern [1-9]{1}[0-9]*

**element Debito\_Type/ImportoDaTrattenere**

diagram	
namespace	urn:www.agenziaentrate.gov.it:specificheTecniche:sco:730
type	<a href="#">DatoNP_Type</a>
facets	Kind Value pattern [1-9]{1}[0-9]*

**complexType Deduzioni\_Modulo\_Type**

diagram	
namespace	urn:www.agenziaentrate.gov.it:specificheTecniche:sco:730
children	<a href="#">m730:AssegnoConiuge</a> <a href="#">m730:AltriOneri</a> <a href="#">m730:AcquistoCostruzioneAbitLocazione</a>

**element Deduzioni\_Modulo\_Type/AssegnoConiuge**

diagram	
namespace	urn:www.agenziaentrate.gov.it:specificheTecniche:sco:730
type	<a href="#">m730:Assegno Coniuge_Type</a>
children	<a href="#">m730:CodiceFiscale</a> <a href="#">m730:Importo</a>

element **Deduzioni\_Modulo\_Type/AltriOneri**

diagram	
namespace	urn:www.agenziaentrate.gov.it:specificheTecniche:sco:730
type	<a href="#">m730:Altri_Oneri_Type</a>
children	<a href="#">m730:Codice</a> <a href="#">m730:Importo</a>

element **Deduzioni\_Modulo\_Type/AcquistoCostruzioneAbitLocazione**

diagram	
namespace	urn:www.agenziaentrate.gov.it:specificheTecniche:sco:730
type	<a href="#">m730:Acquisto_Costruzione_Abit_Type</a>
children	<a href="#">m730:DataStipula</a> <a href="#">m730:Spesa</a> <a href="#">m730:InteressiMutuo</a>

complexType **Deduzioni\_Type**

diagram	
namespace	urn:www.agenziaentrate.gov.it:specificheTecniche:sco:730
children	<a href="#">m730:ContributiPrevAss</a> <a href="#">m730:AssegnoConiuge</a> <a href="#">m730:ContributiColf</a> <a href="#">m730:ErogazioniIstituzioniReligiose</a> <a href="#">m730:SpesePortatoriHandicap</a> <a href="#">m730:AltriOneri</a> <a href="#">m730:DeducibilitaOrdinaria</a> <a href="#">m730:LavoratoriPrimaOccupazione</a> <a href="#">m730:FondiInSquilibrioFinanziario</a> <a href="#">m730:FamiliariACarico</a> <a href="#">m730:FondoPensioneDipendentiPubblici</a> <a href="#">m730:AcquistoCostruzioneAbitLocazione</a> <a href="#">m730:RestituzioneSomme</a>

element **Deduzioni\_Type/ContributiPrevAss**

diagram					
namespace	urn:www.agenziaentrate.gov.it:specificheTecniche:sco:730				
type	<a href="#">DatoNP_Type</a>				
facets	<table border="1"> <tr> <td>Kind</td> <td>Value</td> </tr> <tr> <td>pattern</td> <td>[1-9]{1}[0-9]*</td> </tr> </table>	Kind	Value	pattern	[1-9]{1}[0-9]*
Kind	Value				
pattern	[1-9]{1}[0-9]*				

element **Deduzioni\_Type/AssegnoConiuge**

diagram	
namespace	urn:www.agenziaentrate.gov.it:specificheTecniche:sco:730
type	<a href="#">m730:Assegno_Coniuge_Type</a>
children	<a href="#">m730:CodiceFiscale</a> <a href="#">m730:Importo</a>

element **Deduzioni\_Type/ContributiColf**

diagram					
namespace	urn:www.agenziaentrate.gov.it:specificheTecniche:sco:730				
type	<a href="#">DatoNP_Type</a>				
facets	<table border="1"> <tr> <td>Kind</td> <td>Value</td> </tr> <tr> <td>pattern</td> <td>[1-9]{1}[0-9]*</td> </tr> </table>	Kind	Value	pattern	[1-9]{1}[0-9]*
Kind	Value				
pattern	[1-9]{1}[0-9]*				

element **Deduzioni\_Type/ErogazioniIstituzioniReligiose**

diagram					
namespace	urn:www.agenziaentrate.gov.it:specificheTecniche:sco:730				
type	<a href="#">DatoNP_Type</a>				
facets	<table border="1"> <tr> <td>Kind</td> <td>Value</td> </tr> <tr> <td>pattern</td> <td>[1-9]{1}[0-9]*</td> </tr> </table>	Kind	Value	pattern	[1-9]{1}[0-9]*
Kind	Value				
pattern	[1-9]{1}[0-9]*				

element **Deduzioni\_Type/SpesePortatoriHandicap**

diagram					
namespace	urn:www.agenziaentrate.gov.it:specificheTecniche:sco:730				
type	<a href="#">DatoNP_Type</a>				
facets	<table border="1"> <tr> <td>Kind</td> <td>Value</td> </tr> <tr> <td>pattern</td> <td>[1-9]{1}[0-9]*</td> </tr> </table>	Kind	Value	pattern	[1-9]{1}[0-9]*
Kind	Value				
pattern	[1-9]{1}[0-9]*				



element **Deduzioni\_Type/AltriOneri**

diagram	<p>The diagram shows a dashed box labeled 'm730:AltriOneri' connected to a central octagonal node. This node is connected to a larger dashed box labeled 'm730:Altri_Oneri_Type'. Inside this box are two rectangular boxes: 'm730:Codice' and 'm730:Importo'.</p>
namespace	urn:www.agenziaentrate.gov.it:specificheTecniche:sco:730
type	<a href="#">m730:Altri_Oneri_Type</a>
children	<a href="#">m730:Codice</a> <a href="#">m730:Importo</a>

element **Deduzioni\_Type/DeducibilitaOrdinaria**

diagram	<p>The diagram shows a dashed box labeled 'm730:DeducibilitaOrdinaria' connected to a central octagonal node. This node is connected to a larger dashed box labeled 'm730:Contributi_Previdenza_Complementare_Type'. Inside this box are two dashed boxes: 'm730:EsclusiDalSostituto' and 'm730:NonEsclusiDalSostituto'.</p>
namespace	urn:www.agenziaentrate.gov.it:specificheTecniche:sco:730
type	<a href="#">m730:Contributi_Previdenza_Complementare_Type</a>
children	<a href="#">m730:EsclusiDalSostituto</a> <a href="#">m730:NonEsclusiDalSostituto</a>

element **Deduzioni\_Type/LavoratoriPrimaOccupazione**

diagram	<p>The diagram shows a dashed box labeled 'm730:LavoratoriPrimaOccupazi...' connected to a central octagonal node. This node is connected to a larger dashed box labeled 'm730:Contributi_Previdenza_Complementare_Type'. Inside this box are two dashed boxes: 'm730:EsclusiDalSostituto' and 'm730:NonEsclusiDalSostituto'.</p>
namespace	urn:www.agenziaentrate.gov.it:specificheTecniche:sco:730
type	<a href="#">m730:Contributi_Previdenza_Complementare_Type</a>
children	<a href="#">m730:EsclusiDalSostituto</a> <a href="#">m730:NonEsclusiDalSostituto</a>

element **Deduzioni\_Type/FondiInSquilibrioFinanziario**

diagram	<p>The diagram shows a class <code>m730:FondiInSquilibrioFinanzia...</code> (dashed border) associated with a class <code>m730:Contributi_Previdenza_Complementare_Type</code> (solid border, highlighted in yellow). The association is bidirectional. The <code>m730:Contributi_Previdenza_Complementare_Type</code> class contains two subclasses: <code>m730:EsclusiDalSostituto</code> and <code>m730:NonEsclusiDalSostituto</code>, both shown with dashed borders.</p>
namespace	urn:www.agenziaentrate.gov.it:specificheTecniche:sco:730
type	<a href="#">m730:Contributi_Previdenza_Complementare_Type</a>
children	<a href="#">m730:EsclusiDalSostituto</a> <a href="#">m730:NonEsclusiDalSostituto</a>

element **Deduzioni\_Type/FamiliariACarico**

diagram	<p>The diagram shows a class <code>m730:FamiliariACarico</code> (dashed border) associated with a class <code>m730:Contributi_Previdenza_Complementare_Type</code> (solid border, highlighted in yellow). The association is bidirectional. The <code>m730:Contributi_Previdenza_Complementare_Type</code> class contains two subclasses: <code>m730:EsclusiDalSostituto</code> and <code>m730:NonEsclusiDalSostituto</code>, both shown with dashed borders.</p>
namespace	urn:www.agenziaentrate.gov.it:specificheTecniche:sco:730
type	<a href="#">m730:Contributi_Previdenza_Complementare_Type</a>
children	<a href="#">m730:EsclusiDalSostituto</a> <a href="#">m730:NonEsclusiDalSostituto</a>

element **Deduzioni\_Type/FondoPensioneDipendentiPubblici**

diagram	<p>The diagram shows a class <code>m730:FondoPensioneDipenden...</code> (dashed border) associated with a class <code>m730:Fondo_Pensione_Dipendenti_Pubblici_Type</code> (solid border, highlighted in yellow). The association is bidirectional. The <code>m730:Fondo_Pensione_Dipendenti_Pubblici_Type</code> class contains two subclasses: <code>m730:Contributi</code> and <code>m730:QuotaTFR</code>, both shown with dashed borders. The <code>m730:Contributi</code> class has a plus sign icon in its top right corner.</p>
namespace	urn:www.agenziaentrate.gov.it:specificheTecniche:sco:730
type	<a href="#">m730:Fondo_Pensione_Dipendenti_Pubblici_Type</a>
children	<a href="#">m730:Contributi</a> <a href="#">m730:QuotaTFR</a>

element **Deduzioni\_Type/AcquistoCostruzioneAbitLocazione**

diagram	
namespace	urn:www.agenziaentrate.gov.it:specificheTecniche:sco:730
type	<a href="#">m730:Acquisto_Costruzione_Abit_Type</a>
children	<a href="#">m730:DataStipula</a> <a href="#">m730:Spesa</a> <a href="#">m730:InteressiMutuo</a>

element **Deduzioni\_Type/RestituzioneSomme**

diagram	
namespace	urn:www.agenziaentrate.gov.it:specificheTecniche:sco:730
type	<a href="#">m730:Restituzione_Somme_Type</a>
children	<a href="#">m730:SommeRestituite</a> <a href="#">m730:ResiduoPrecedenteDic</a>

complexType **Detrazione\_Crediti\_Type**

<p>diagram</p>	
<p>namespace</p>	<p>urn:www.agenziaentrate.gov.it:specificheTecniche:sco:730</p>
<p>children</p>	<p><a href="#">m730:DetrazioneConiuge</a> <a href="#">m730:DetrazioneFigli</a> <a href="#">m730:UlterioreDetrazioneFigli</a> <a href="#">m730:DetrazioneFamiliari</a> <a href="#">m730:DetrazioneLavDip</a> <a href="#">m730:DetrazionePens</a> <a href="#">m730:DetrazioneAltriRedditi</a> <a href="#">m730:DetrazioneOneri</a> <a href="#">m730:DetrazioneRistrutturazione</a> <a href="#">m730:DetrazioniArredolmmobili</a> <a href="#">m730:DetrazioneRisparmioEnergetico</a> <a href="#">m730:DetrazioneArredoGiovaniCoppie</a> <a href="#">m730:DetrazionelvaAcquistoAbitaz</a> <a href="#">m730:DetrazioneLocEAgricoliGiovani</a> <a href="#">m730:AltreDetrazioni</a> <a href="#">m730:CreditoPrimaCasa</a> <a href="#">m730:CreditoOccupazione</a> <a href="#">m730:CreditoFondiPensione</a> <a href="#">m730:CreditoMediazioni</a> <a href="#">m730:CreditoNegoziazione</a> <a href="#">m730:TotaleDetrazioniCrediti</a></p>

element **Detrazione\_Crediti\_Type/DetrazioneConiuge**

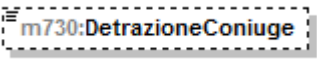
diagram	
namespace	urn:www.agenziaentrate.gov.it:specificheTecniche:sco:730
type	<a href="#">DatoNP_Type</a>
facets	Kind Value pattern [1-9]{1}[0-9]*

element **Detrazione\_Crediti\_Type/DetrazioneFigli**

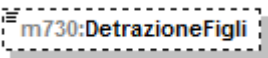
diagram	
namespace	urn:www.agenziaentrate.gov.it:specificheTecniche:sco:730
type	<a href="#">DatoNP_Type</a>
facets	Kind Value pattern [1-9]{1}[0-9]*

element **Detrazione\_Crediti\_Type/UlterioreDetrazioneFigli**

diagram	
namespace	urn:www.agenziaentrate.gov.it:specificheTecniche:sco:730
type	<a href="#">DatoNP_Type</a>
facets	Kind Value pattern [1-9]{1}[0-9]*

element **Detrazione\_Crediti\_Type/DetrazioneFamiliari**

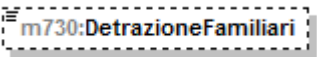
diagram	
namespace	urn:www.agenziaentrate.gov.it:specificheTecniche:sco:730
type	<a href="#">DatoNP_Type</a>
facets	Kind Value pattern [1-9]{1}[0-9]*

element **Detrazione\_Crediti\_Type/DetrazioneLavDip**

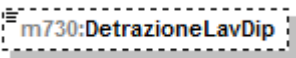
diagram	
namespace	urn:www.agenziaentrate.gov.it:specificheTecniche:sco:730
type	<a href="#">DatoNP_Type</a>

facets	Kind pattern	Value [1-9]{1}[0-9]*
--------	-----------------	-------------------------

#### element **Detrazione\_Crediti\_Type/DetrazionePens**

diagram		
namespace	urn:www.agenziaentrate.gov.it:specificheTecniche:sco:730	
type	<a href="#">DatoNP_Type</a>	
facets	Kind pattern	Value [1-9]{1}[0-9]*

#### element **Detrazione\_Crediti\_Type/DetrazioneAltriRedditi**

diagram		
namespace	urn:www.agenziaentrate.gov.it:specificheTecniche:sco:730	
type	<a href="#">DatoNP_Type</a>	
facets	Kind pattern	Value [1-9]{1}[0-9]*

#### element **Detrazione\_Crediti\_Type/DetrazioneOneri**

diagram		
namespace	urn:www.agenziaentrate.gov.it:specificheTecniche:sco:730	
type	<a href="#">DatoNP_Type</a>	
facets	Kind pattern	Value [1-9]{1}[0-9]*

#### element **Detrazione\_Crediti\_Type/DetrazioneRistrutturazione**

diagram		
namespace	urn:www.agenziaentrate.gov.it:specificheTecniche:sco:730	
type	<a href="#">DatoNP_Type</a>	
facets	Kind pattern	Value [1-9]{1}[0-9]*

#### element **Detrazione\_Crediti\_Type/DetrazioniArredolImmobili**

diagram		
namespace	urn:www.agenziaentrate.gov.it:specificheTecniche:sco:730	

type	<a href="#">DatoNP_Type</a>
facets	Kind Value pattern [1-9]{1}[0-9]*

element **Detrazione\_Crediti\_Type/DetrazioneRisparmioEnergetico**

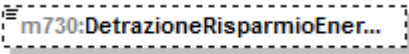
diagram	
namespace	urn:www.agenziaentrate.gov.it:specificheTecniche:sco:730
type	<a href="#">DatoNP_Type</a>
facets	Kind Value pattern [1-9]{1}[0-9]*

element **Detrazione\_Crediti\_Type/DetrazioneArredoGiovaniCoppie**

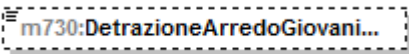
diagram	
namespace	urn:www.agenziaentrate.gov.it:specificheTecniche:sco:730
type	<a href="#">DatoNP_Type</a>
facets	Kind Value pattern [1-9]{1}[0-9]*

element **Detrazione\_Crediti\_Type/DetrazioneIvaAcquistoAbitaz**

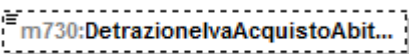
diagram	
namespace	urn:www.agenziaentrate.gov.it:specificheTecniche:sco:730
type	<a href="#">DatoNP_Type</a>
facets	Kind Value pattern [1-9]{1}[0-9]*

element **Detrazione\_Crediti\_Type/DetrazioneLocEAgricoliGiovani**

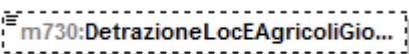
diagram	
namespace	urn:www.agenziaentrate.gov.it:specificheTecniche:sco:730
type	<a href="#">DatoNP_Type</a>
facets	Kind Value pattern [1-9]{1}[0-9]*

element **Detrazione\_Crediti\_Type/AltreDetrazioni**

diagram	
---------	---

namespace	urn:www.agenziaentrate.gov.it:specificheTecniche:sco:730
type	<a href="#">DatoNP_Type</a>
facets	Kind Value pattern [1-9]{1}[0-9]*

#### element **Detrazione\_Crediti\_Type/CreditoPrimaCasa**

diagram	
namespace	urn:www.agenziaentrate.gov.it:specificheTecniche:sco:730
type	<a href="#">DatoNP_Type</a>
facets	Kind Value pattern [1-9]{1}[0-9]*

#### element **Detrazione\_Crediti\_Type/CreditoOccupazione**

diagram	
namespace	urn:www.agenziaentrate.gov.it:specificheTecniche:sco:730
type	<a href="#">DatoNP_Type</a>
facets	Kind Value pattern [1-9]{1}[0-9]*

#### element **Detrazione\_Crediti\_Type/CreditoFondiPensione**

diagram	
namespace	urn:www.agenziaentrate.gov.it:specificheTecniche:sco:730
type	<a href="#">DatoNP_Type</a>
facets	Kind Value pattern [1-9]{1}[0-9]*

#### element **Detrazione\_Crediti\_Type/CreditoMediazioni**

diagram	
namespace	urn:www.agenziaentrate.gov.it:specificheTecniche:sco:730
type	<a href="#">DatoNP_Type</a>
facets	Kind Value pattern [1-9]{1}[0-9]*



element **Detrazione\_Crediti\_Type/CreditoNegoziazione**

diagram	
namespace	urn:www.agenziaentrate.gov.it:specificheTecniche:sco:730
type	<a href="#">DatoNP_Type</a>
facets	Kind Value pattern [1-9]{1}[0-9]*

element **Detrazione\_Crediti\_Type/TotaleDetrazioniCrediti**

diagram	
namespace	urn:www.agenziaentrate.gov.it:specificheTecniche:sco:730
type	<a href="#">DatoNP_Type</a>
facets	Kind Value pattern [1-9]{1}[0-9]*

complexType **Detrazioni\_Canoni\_Locazione\_Type**

diagram	
namespace	urn:www.agenziaentrate.gov.it:specificheTecniche:sco:730
children	<a href="#">m730:InquiliniAbitazionePrincipale</a> <a href="#">m730:DipendentiTrasferiti</a>

element **Detrazioni\_Canoni\_Locazione\_Type/InquiliniAbitazionePrincipale**

diagram	
namespace	urn:www.agenziaentrate.gov.it:specificheTecniche:sco:730
type	<a href="#">m730:Inquilini_Abitazione_Principale_Type</a>
children	<a href="#">m730:Tipologia</a> <a href="#">m730:GiorniPercentuale</a>

element **Detrazioni\_Canoni\_Locazione\_Type/DipendentiTrasferiti**

diagram	
namespace	urn:www.agenziaentrate.gov.it:specificheTecniche:sco:730
type	<a href="#">m730:Giorni_Percentuale_Type</a>
children	<a href="#">m730:Giorni</a> <a href="#">m730:Percentuale</a>

complexType **Detrazioni\_Modulo\_Type**

diagram	
namespace	urn:www.agenziaentrate.gov.it:specificheTecniche:sco:730
children	<a href="#">m730:VeicoliDisabili</a> <a href="#">m730:AcquistoCaniGuida</a> <a href="#">m730:SpeseRateizzate</a> <a href="#">m730:AltreSpese</a> <a href="#">m730:SpeseLeasing</a>

element **Detrazioni\_Modulo\_Type/VeicoliDisabili**

diagram	
namespace	urn:www.agenziaentrate.gov.it:specificheTecniche:sco:730
type	<a href="#">m730:Spese_Rateizzate_Type</a>
children	<a href="#">m730:Codice</a> <a href="#">m730:Importo</a>

element **Detrazioni\_Modulo\_Type/AcquistoCaniGuida**

diagram	
namespace	urn:www.agenziaentrate.gov.it:specificheTecniche:sco:730
type	<a href="#">m730:Spese_Rateizzate_Type</a>
children	<a href="#">m730:Codice</a> <a href="#">m730:Importo</a>

element **Detrazioni\_Modulo\_Type/SpeseRateizzate**

diagram	
namespace	urn:www.agenziaentrate.gov.it:specificheTecniche:sco:730
type	<a href="#">m730:Spese_Rateizzate_Anni_Precedenti_Type</a>
children	<a href="#">m730:Codice</a> <a href="#">m730:Importo</a>

element **Detrazioni\_Modulo\_Type/AltreSpese**

diagram	
namespace	urn:www.agenziaentrate.gov.it:specificheTecniche:sco:730
type	<a href="#">m730:Altre_Spese_Type</a>
children	<a href="#">m730:Codice</a> <a href="#">m730:Importo</a>

element **Detrazioni\_Modulo\_Type/SpeseLeasing**

diagram	
namespace	urn:www.agenziaentrate.gov.it:specificheTecniche:sco:730
type	<a href="#">m730:Spese_Leasing_Type</a>
children	<a href="#">m730:DataStipula</a> <a href="#">m730:NumeroAnno</a> <a href="#">m730:Canone</a> <a href="#">m730:PrezzoRiscatto</a>

complexType **Detrazioni\_Type**

diagram	
namespace	urn:www.agenziaentrate.gov.it:specificheTecniche:sco:730
children	<a href="#">m730:CasellaRateazione</a> <a href="#">m730:SpeseDeterminatePatologie</a> <a href="#">m730:SpeseSanitarie</a> <a href="#">m730:SpeseFamNonACarico</a> <a href="#">m730:SpeseSanitarieDisabili</a> <a href="#">m730:VeicoliDisabili</a> <a href="#">m730:AcquistoCaniGuida</a> <a href="#">m730:SpeseRateizzate</a> <a href="#">m730:MutuiAbPrincipale</a> <a href="#">m730:AltreSpese</a> <a href="#">m730:SpeseLeasing</a>

element **Detrazioni\_Type/CasellaRateazione**

diagram	 <b>m730:CasellaRateazione</b>
namespace	urn:www.agenziaentrate.gov.it:specificheTecniche:sco:730
type	<a href="#">DatoCB_Type</a>
facets	Kind Value pattern [01]

element **Detrazioni\_Type/SpeseDeterminatePatologie**

diagram	 <b>m730:SpeseDeterminatePatologie</b>
namespace	urn:www.agenziaentrate.gov.it:specificheTecniche:sco:730
type	<a href="#">DatoNP_Type</a>
facets	Kind Value pattern [1-9]{1}[0-9]*

element **Detrazioni\_Type/SpeseSanitarie**

diagram	 <b>m730:Spese Sanitarie</b>
namespace	urn:www.agenziaentrate.gov.it:specificheTecniche:sco:730
type	<a href="#">DatoNP_Type</a>
facets	Kind Value pattern [1-9]{1}[0-9]*

element **Detrazioni\_Type/SpeseFamNonACarico**

diagram	 <b>m730:SpeseFamNonACarico</b>
namespace	urn:www.agenziaentrate.gov.it:specificheTecniche:sco:730
type	<a href="#">DatoNP_Type</a>
facets	Kind Value pattern [1-9]{1}[0-9]*

element **Detrazioni\_Type/SpeseSanitarieDisabili**

diagram	 <b>m730:Spese SanitarieDisabili</b>
namespace	urn:www.agenziaentrate.gov.it:specificheTecniche:sco:730
type	<a href="#">DatoNP_Type</a>
facets	Kind Value pattern [1-9]{1}[0-9]*

element **Detrazioni\_Type/VeicoliDisabili**

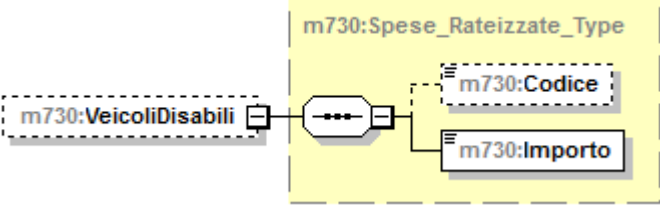
diagram	
namespace	urn:www.agenziaentrate.gov.it:specificheTecniche:sco:730
type	<a href="#">m730:Spese_Rateizzate_Type</a>
children	<a href="#">m730:Codice</a> <a href="#">m730:Importo</a>

element **Detrazioni\_Type/AcquistoCaniGuida**

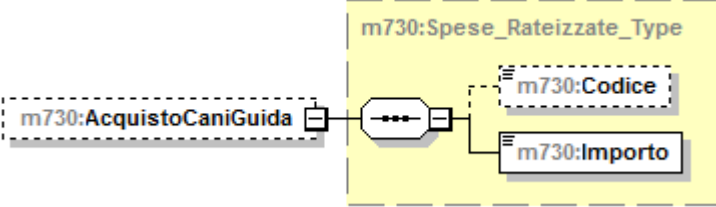
diagram	
namespace	urn:www.agenziaentrate.gov.it:specificheTecniche:sco:730
type	<a href="#">m730:Spese_Rateizzate_Type</a>
children	<a href="#">m730:Codice</a> <a href="#">m730:Importo</a>

element **Detrazioni\_Type/SpeseRateizzate**

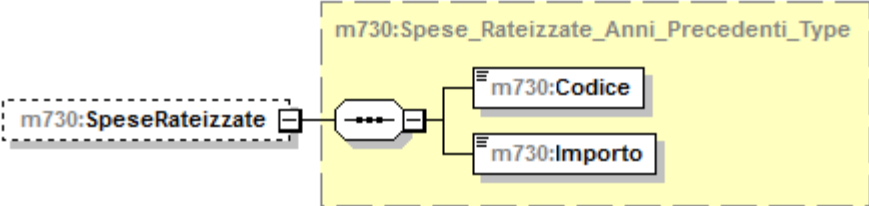
diagram	
namespace	urn:www.agenziaentrate.gov.it:specificheTecniche:sco:730
type	<a href="#">m730:Spese_Rateizzate_Anni_Precedenti_Type</a>
children	<a href="#">m730:Codice</a> <a href="#">m730:Importo</a>

element **Detrazioni\_Type/MutuiAbPrincipale**

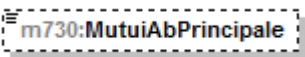
diagram	
namespace	urn:www.agenziaentrate.gov.it:specificheTecniche:sco:730

type	<a href="#">DatoNP_Type</a>
facets	Kind Value pattern [1-9]{1}[0-9]*

### element **Detrazioni\_Type/AltreSpese**

diagram	
namespace	urn:www.agenziaentrate.gov.it:specificheTecniche:sco:730
type	<a href="#">m730:Altre_Spese_Type</a>
children	<a href="#">m730:Codice</a> <a href="#">m730:Importo</a>

### element **Detrazioni\_Type/SpeseLeasing**

diagram	
namespace	urn:www.agenziaentrate.gov.it:specificheTecniche:sco:730
type	<a href="#">m730:Spese_Leasing_Type</a>
children	<a href="#">m730:DataStipula</a> <a href="#">m730:NumeroAnno</a> <a href="#">m730:Canone</a> <a href="#">m730:PrezzoRiscatto</a>

### complexType **Dichiarazione\_Con\_Type**

diagram	
namespace	urn:www.agenziaentrate.gov.it:specificheTecniche:sco:730

children	<a href="#">m730:Frontespizio</a> <a href="#">m730:DatiContabili</a> <a href="#">m730:FuoriAssistenzaQuadri</a> <a href="#">m730:Scelte</a>
----------	---

element **Dichiarazione\_Con\_Type/Frontespizio**

diagram	
namespace	urn:www.agenziaentrate.gov.it:specificheTecniche:sco:730
type	<a href="#">m730:Frontespizio_Con_Type</a>
children	<a href="#">m730:SoggettoFiscale</a> <a href="#">m730:DatiAnagrafici</a> <a href="#">m730:StatoCivile</a> <a href="#">m730:ResidenzaAnagrafica</a> <a href="#">m730:DomicilioFiscaleSaldo</a> <a href="#">m730:DomicilioFiscaleAcconto</a> <a href="#">m730:CasiParticolariAddizionale</a> <a href="#">m730:Firma</a>



element **Dichiarazione\_Con\_Type/DatiContabili**

<p>diagram</p>	
<p>namespace</p>	<p>urn:www.agenziaentrate.gov.it:specificheTecniche:sco:730</p>
<p>type</p>	<p><a href="#">m730:Dati_Contabili_Type</a></p>
<p>children</p>	<p><a href="#">m730:Familiari</a> <a href="#">m730:QuadroA</a> <a href="#">m730:QuadroB</a> <a href="#">m730:QuadroC</a> <a href="#">m730:QuadroD</a> <a href="#">m730:QuadroE</a> <a href="#">m730:QuadroF</a> <a href="#">m730:QuadroG</a> <a href="#">m730:QuadroI</a> <a href="#">m730:ProspettoLiquidazione</a> <a href="#">m730:Prospetto_Anotazioni</a> <a href="#">m730:QuadroK</a></p>

element **Dichiarazione\_Con\_Type/FuoriAssistenzaQuadri**

diagram	
namespace	urn:www.agenziaentrate.gov.it:specificheTecniche:sco:730
type	<a href="#">m730:Fuori_Assistenza_Type</a>
children	<a href="#">m730:AnomaliaDatianagrafici</a> <a href="#">m730:AnomaliaTerreni</a> <a href="#">m730:AnomaliaFabbricati</a> <a href="#">m730:AnomaliaLavDip</a> <a href="#">m730:AnomaliaAltriRedditi</a> <a href="#">m730:AnomaliaQuadroF</a>

element **Dichiarazione\_Con\_Type/Scelte**

diagram	
namespace	urn:www.agenziaentrate.gov.it:specificheTecniche:sco:730
type	<a href="#">sce:Scelte_Type</a>
children	<a href="#">sce:Scelta5PerMille</a> <a href="#">sce:Scelta8PerMille</a> <a href="#">sce:Scelta2PerMille</a>

complexType **Dichiarazione\_Dich\_Type**

diagram	
---------	--

namespace	urn:www.agenziaentrate.gov.it:specificheTecniche:sco:730
children	<a href="#">m730:Frontespizio</a> <a href="#">m730:DatiContabili</a> <a href="#">m730:FuoriAssistenza</a> <a href="#">m730:Scelte</a>

element **Dichiarazione\_Dich\_Type/**Frontespizio

diagram	<pre> classDiagram     class m730Frontespizio     class m730Frontespizio_Dich_Type["m730:Frontespizio_Dich_Type (extension)"]     class m730SoggettoFiscale     class m730DatiAnagrafici     class m730StatoCivile     class m730ResidenzaAnagrafica     class m730DomicilioFiscale_Saldo["m730:DomicilioFiscale Saldo"]     class m730DomicilioFiscale_Acconto["m730:DomicilioFiscaleAcconto"]     class m730CasiParticolariAddizionale     class m730Firma     class m730Rappresentante      m730Frontespizio_Dich_Type -- &gt; m730Frontespizio     m730Frontespizio_Dich_Type -- m730SoggettoFiscale     m730Frontespizio_Dich_Type -- m730DatiAnagrafici     m730Frontespizio_Dich_Type -- m730StatoCivile     m730Frontespizio_Dich_Type -- m730ResidenzaAnagrafica     m730Frontespizio_Dich_Type -- m730DomicilioFiscale_Saldo     m730Frontespizio_Dich_Type -- m730DomicilioFiscale_Acconto     m730Frontespizio_Dich_Type -- m730CasiParticolariAddizionale     m730Frontespizio_Dich_Type -- m730Firma     m730Frontespizio_Dich_Type -- m730Rappresentante     </pre>
namespace	urn:www.agenziaentrate.gov.it:specificheTecniche:sco:730
type	extension of <a href="#">m730:Frontespizio Dich_Type</a>
children	<a href="#">m730:SoggettoFiscale</a> <a href="#">m730:DatiAnagrafici</a> <a href="#">m730:StatoCivile</a> <a href="#">m730:ResidenzaAnagrafica</a> <a href="#">m730:DomicilioFiscaleSaldo</a> <a href="#">m730:DomicilioFiscaleAcconto</a> <a href="#">m730:CasiParticolariAddizionale</a> <a href="#">m730:Firma</a> <a href="#">m730:Rappresentante</a>

element **Dichiarazione\_Dich\_Type/DatiContabili**

<p>diagram</p>	
<p>namespace</p>	<p>urn:www.agenziaentrate.gov.it:specificheTecniche:sco:730</p>
<p>type</p>	<p><a href="#">m730:Dati_Contabili_Type</a></p>
<p>children</p>	<p><a href="#">m730:Familiari</a> <a href="#">m730:QuadroA</a> <a href="#">m730:QuadroB</a> <a href="#">m730:QuadroC</a> <a href="#">m730:QuadroD</a> <a href="#">m730:QuadroE</a> <a href="#">m730:QuadroF</a> <a href="#">m730:QuadroG</a> <a href="#">m730:QuadroI</a> <a href="#">m730:ProspettoLiquidazione</a> <a href="#">m730:Prospetto_Annotazioni</a> <a href="#">m730:QuadroK</a></p>

element **Dichiarazione\_Dich\_Type/FuoriAssistenza**

<p>diagram</p>	
<p>namespace</p>	<p>urn:www.agenziaentrate.gov.it:specificheTecniche:sco:730</p>
<p>children</p>	<p><a href="#">m730:FuoriAssistenzaQuadri</a> <a href="#">m730:AnomaliaDatiSostituto</a> <a href="#">m730:AnomaliaDatiRappresentante</a></p>

element **Dichiarazione\_Dich\_Type/FuoriAssistenza/FuoriAssistenzaQuadri**

diagram	
namespace	urn:www.agenziaentrate.gov.it:specificheTecniche:sco:730
type	<a href="#">m730:Fuori_Assistenza_Type</a>
children	<a href="#">m730:AnomaliaDatianagrafici</a> <a href="#">m730:AnomaliaTerreni</a> <a href="#">m730:AnomaliaFabbricati</a> <a href="#">m730:AnomaliaLavDip</a> <a href="#">m730:AnomaliaAltriRedditi</a> <a href="#">m730:AnomaliaQuadroF</a>

element **Dichiarazione\_Dich\_Type/FuoriAssistenza/AnomaliaDatiSostituto**

diagram					
namespace	urn:www.agenziaentrate.gov.it:specificheTecniche:sco:730				
type	<a href="#">DatoCB_Type</a>				
facets	<table border="1"> <thead> <tr> <th>Kind</th> <th>Value</th> </tr> </thead> <tbody> <tr> <td>pattern</td> <td>[01]</td> </tr> </tbody> </table>	Kind	Value	pattern	[01]
Kind	Value				
pattern	[01]				

element **Dichiarazione\_Dich\_Type/FuoriAssistenza/AnomaliaDatiRappresentante**

diagram					
namespace	urn:www.agenziaentrate.gov.it:specificheTecniche:sco:730				
type	<a href="#">DatoCB_Type</a>				
facets	<table border="1"> <thead> <tr> <th>Kind</th> <th>Value</th> </tr> </thead> <tbody> <tr> <td>pattern</td> <td>[01]</td> </tr> </tbody> </table>	Kind	Value	pattern	[01]
Kind	Value				
pattern	[01]				

element **Dichiarazione\_Dich\_Type/Scelte**

diagram	
namespace	urn:www.agenziaentrate.gov.it:specificheTecniche:sco:730
type	<a href="#">sce:Scelte_Type</a>
children	<a href="#">sce:Scelta5PerMille</a> <a href="#">sce:Scelta8PerMille</a> <a href="#">sce:Scelta2PerMille</a>

complexType **Documento\_730-4**

diagram	
namespace	urn:www.agenziaentrate.gov.it:specificheTecniche:sco:730
children	<a href="#">m730:DatiAnagraficiDichiarante</a> <a href="#">m730:Sostituto</a> <a href="#">m730:SoggettoAssFiscale730-4</a> <a href="#">m730:AltriDati</a> <a href="#">m730:DatiContabili730-4</a>

element Documento\_730-4/DatiAnagraficiDichiarante

diagram	
namespace	urn:www.agenziaentrate.gov.it:specificheTecniche:sco:730
type	extension of <a href="#">Dati_Anagrafici_Type</a>
children	<a href="#">Cognome</a> <a href="#">Nome</a> <a href="#">Sesso</a> <a href="#">DataNascita</a> <a href="#">ComuneNascita</a> <a href="#">ProvinciaNascita</a> <a href="#">m730:CFDichiarante</a>

element Documento\_730-4/DatiAnagraficiDichiarante/CFDichiarante

diagram					
namespace	urn:www.agenziaentrate.gov.it:specificheTecniche:sco:730				
type	<a href="#">DatoCF_Type</a>				
facets	<table border="1"> <thead> <tr> <th>Kind</th> <th>Value</th> </tr> </thead> <tbody> <tr> <td>pattern</td> <td>[0-9]{11}[A-Z]{6}[0-9LMNPQRSTU]{2}[A-Z]{1}[0-9LMNPQRSTU]{2}[A-Z]{1}[0-9LMNPQRSTU]{3}[A-Z]{1}</td> </tr> </tbody> </table>	Kind	Value	pattern	[0-9]{11}[A-Z]{6}[0-9LMNPQRSTU]{2}[A-Z]{1}[0-9LMNPQRSTU]{2}[A-Z]{1}[0-9LMNPQRSTU]{3}[A-Z]{1}
Kind	Value				
pattern	[0-9]{11}[A-Z]{6}[0-9LMNPQRSTU]{2}[A-Z]{1}[0-9LMNPQRSTU]{2}[A-Z]{1}[0-9LMNPQRSTU]{3}[A-Z]{1}				

element **Documento\_730-4/Sostituto**

diagram	
namespace	urn:www.agenziaentrate.gov.it:specificheTecniche:sco:730
type	<a href="#">m730:Sostituto_Type</a>
children	<a href="#">m730:CodiceFiscale</a> <a href="#">m730:DatiAnagraficiPF</a> <a href="#">m730:DenominazionePNF</a> <a href="#">m730:Residenza</a> <a href="#">m730:Fax</a> <a href="#">m730:CodiceSede</a>

element **Documento\_730-4/SoggettoAssFiscale730-4**

diagram	
namespace	urn:www.agenziaentrate.gov.it:specificheTecniche:sco:730
children	<a href="#">m730:DatiCaf730-4</a> <a href="#">m730:DatiProfessionista730-4</a> <a href="#">m730:DatiAssociazione730-4</a> <a href="#">m730:DatiAgenzia730-4</a> <a href="#">m730:CasellaSostituto</a>



element **Documento\_730-4/SoggettoAssFiscale730-4/DatiCaf730-4**

diagram	
namespace	urn:www.agenziaentrate.gov.it:specificheTecniche:sco:730
type	extension of <a href="#">m730:Dati_CAF_Type</a>
children	<a href="#">m730:CFCaf</a> <a href="#">m730:DenominazioneCaf</a> <a href="#">m730:NumeroAlbo</a> <a href="#">m730:DomicilioCaf</a> <a href="#">m730:UfficioPerifericoCaf</a>

element **Documento\_730-4/SoggettoAssFiscale730-4/DatiCaf730-4/DomicilioCaf**

diagram	
namespace	urn:www.agenziaentrate.gov.it:specificheTecniche:sco:730
type	<a href="#">m730:Domicilio_Sogg_Ass_Fiscale_Type</a>
children	<a href="#">m730:Comune</a> <a href="#">m730:Provincia</a> <a href="#">m730:CodiceComune</a> <a href="#">m730:Cap</a> <a href="#">m730:Indirizzo</a> <a href="#">m730:Telefono</a> <a href="#">m730:FAX</a> <a href="#">m730:Email</a>

element **Documento\_730-4/SoggettoAssFiscale730-4/DatiCaf730-4/UfficioPerifericoCaf**

diagram	
namespace	urn:www.agenziaentrate.gov.it:specificheTecniche:sco:730
children	<a href="#">m730:DomicilioUffPeriferico</a>

element **Documento\_730-4/SoggettoAssFiscale730-4/DatiCaf730-4/UfficioPerifericoCaf/DomicilioUffPeriferico**

diagram	
namespace	urn:www.agenziaentrate.gov.it:specificheTecniche:sco:730
type	extension of <a href="#">m730:Domicilio Sogg Ass Fiscale Type</a>
children	<a href="#">m730:Comune</a> <a href="#">m730:Provincia</a> <a href="#">m730:CodiceComune</a> <a href="#">m730:Cap</a> <a href="#">m730:Indirizzo</a> <a href="#">m730:Telefono</a> <a href="#">m730:FAX</a> <a href="#">m730:Email</a> <a href="#">m730:CodiceSedePeriferica</a>

element **Documento\_730-4/SoggettoAssFiscale730-4/DatiCaf730-4/UfficioPerifericoCaf/DomicilioUffPeriferico/CodiceSedePeriferica**

diagram					
namespace	urn:www.agenziaentrate.gov.it:specificheTecniche:sco:730				
type	<a href="#">DatoAN Type</a>				
facets	<table border="0"> <tr> <td>Kind</td> <td>Value</td> </tr> <tr> <td>pattern</td> <td>([0-9A-Z- &amp;quot;}{1}{[ 0-9A-Z&amp;amp;:] "- \- . / ° °\^\(\ )\ À È Ì Ò Ù Û &amp;quot; \ \\ / +)*</td> </tr> </table>	Kind	Value	pattern	([0-9A-Z- &quot;}{1}{[ 0-9A-Z&amp;:] "- \- . / ° °\^\(\ )\ À È Ì Ò Ù Û &quot; \ \\ / +)*
Kind	Value				
pattern	([0-9A-Z- &quot;}{1}{[ 0-9A-Z&amp;:] "- \- . / ° °\^\(\ )\ À È Ì Ò Ù Û &quot; \ \\ / +)*				

element **Documento\_730-4/SoggettoAssFiscale730-4/DatiProfessionista730-4**

diagram	<p>The diagram shows a class <code>m730:DatiProfessionista730-4</code> extending the class <code>m730:Dati_Professionista_Type (extension)</code>. The extension includes four child elements: <code>m730:CFProfessionista</code>, <code>m730:CognomeProfessionista</code>, <code>m730:NomeProfessionista</code>, and <code>m730:DomicilioProf</code>.</p>
namespace	urn:www.agenziaentrate.gov.it:specificheTecniche:sco:730
type	extension of <a href="#">m730:Dati Professionista Type</a>
children	<a href="#">m730:CFProfessionista</a> <a href="#">m730:CognomeProfessionista</a> <a href="#">m730:NomeProfessionista</a> <a href="#">m730:DomicilioProf</a>

element **Documento\_730-4/SoggettoAssFiscale730-4/DatiProfessionista730-4/DomicilioProf**

diagram	<p>The diagram shows a class <code>m730:DomicilioProf</code> extending the class <code>m730:Domicilio_Sogg_Ass_Fiscale_Type</code>. The extension includes eight child elements: <code>m730:Comune</code>, <code>m730:Provincia</code>, <code>m730:CodiceComune</code>, <code>m730:Cap</code>, <code>m730:Indirizzo</code>, <code>m730:Telefono</code>, <code>m730:FAX</code>, and <code>m730:Email</code>.</p>
namespace	urn:www.agenziaentrate.gov.it:specificheTecniche:sco:730
type	<a href="#">m730:Domicilio Sogg Ass Fiscale Type</a>
children	<a href="#">m730:Comune</a> <a href="#">m730:Provincia</a> <a href="#">m730:CodiceComune</a> <a href="#">m730:Cap</a> <a href="#">m730:Indirizzo</a> <a href="#">m730:Telefono</a> <a href="#">m730:FAX</a> <a href="#">m730:Email</a>

element Documento\_730-4/SoggettoAssFiscale730-4/DatiAssociazione730-4

<p>diagram</p>	
<p>namespace</p>	<p>urn:www.agenziaentrate.gov.it:specificheTecniche:sco:730</p>
<p>type</p>	<p>extension of <a href="#">m730:Dati_Associazioni_Professionale_Type</a></p>
<p>children</p>	<p><a href="#">m730:CFAssociazione</a> <a href="#">m730:DenominazioneAssociazione</a> <a href="#">m730:CFProfessionista</a> <a href="#">m730:CognomeProfessionista</a> <a href="#">m730:NomeProfessionista</a> <a href="#">m730:DomicilioAssociazione</a></p>

element Documento\_730-4/SoggettoAssFiscale730-4/DatiAssociazione730-4/DomicilioAssociazione

<p>diagram</p>	
<p>namespace</p>	<p>urn:www.agenziaentrate.gov.it:specificheTecniche:sco:730</p>
<p>type</p>	<p><a href="#">m730:Domicilio_Sogg_Ass_Fiscale_Type</a></p>
<p>children</p>	<p><a href="#">m730:Comune</a> <a href="#">m730:Provincia</a> <a href="#">m730:CodiceComune</a> <a href="#">m730:Cap</a> <a href="#">m730:Indirizzo</a> <a href="#">m730:Telefono</a> <a href="#">m730:FAX</a> <a href="#">m730:Email</a></p>

element **Documento\_730-4/SoggettoAssFiscale730-4/DatiAgenzia730-4**

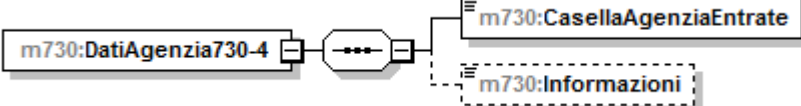
diagram	
namespace	urn:www.agenziaentrate.gov.it:specificheTecniche:sco:730
children	<a href="#">m730:CasellaAgenziaEntrate</a> <a href="#">m730:Informazioni</a>

element **Documento\_730-4/SoggettoAssFiscale730-4/DatiAgenzia730-4/CasellaAgenziaEntrate**

diagram					
namespace	urn:www.agenziaentrate.gov.it:specificheTecniche:sco:730				
type	<a href="#">DatoCB Type</a>				
facets	<table border="1"> <thead> <tr> <th>Kind</th> <th>Value</th> </tr> </thead> <tbody> <tr> <td>pattern</td> <td>[01]</td> </tr> </tbody> </table>	Kind	Value	pattern	[01]
Kind	Value				
pattern	[01]				

element **Documento\_730-4/SoggettoAssFiscale730-4/DatiAgenzia730-4/Informazioni**

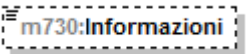
diagram					
namespace	urn:www.agenziaentrate.gov.it:specificheTecniche:sco:730				
type	<a href="#">DatoAN Type</a>				
facets	<table border="1"> <thead> <tr> <th>Kind</th> <th>Value</th> </tr> </thead> <tbody> <tr> <td>pattern</td> <td>(([0-9A-Z-] \&amp;quot;){1}([ 0-9A-Z&amp;amp;:] \" \- \., / ° ^\(\\ )\) À É Ì Ò Ù Û &amp;quot; \\ \\ \\+)*</td> </tr> </tbody> </table>	Kind	Value	pattern	(([0-9A-Z-] \&quot;){1}([ 0-9A-Z&amp;:] \" \- \., / ° ^\(\\ )\) À É Ì Ò Ù Û &quot; \\ \\ \\+)*
Kind	Value				
pattern	(([0-9A-Z-] \&quot;){1}([ 0-9A-Z&amp;:] \" \- \., / ° ^\(\\ )\) À É Ì Ò Ù Û &quot; \\ \\ \\+)*				

element **Documento\_730-4/SoggettoAssFiscale730-4/CasellaSostituto**

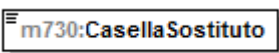
diagram					
namespace	urn:www.agenziaentrate.gov.it:specificheTecniche:sco:730				
type	<a href="#">DatoCB Type</a>				
facets	<table border="1"> <thead> <tr> <th>Kind</th> <th>Value</th> </tr> </thead> <tbody> <tr> <td>pattern</td> <td>[01]</td> </tr> </tbody> </table>	Kind	Value	pattern	[01]
Kind	Value				
pattern	[01]				

element **Documento\_730-4/AltriDati**

diagram	
namespace	urn:www.agenziaentrate.gov.it:specificheTecniche:sco:730
children	<a href="#">m730:Rettificativo</a> <a href="#">m730:Integrativo</a> <a href="#">m730:Annullamento</a> <a href="#">m730:SpazioDisposizioneUtente</a> <a href="#">m730:SituazioniParticolari</a>

element **Documento\_730-4/AltriDati/Rettificativo**

diagram											
namespace	urn:www.agenziaentrate.gov.it:specificheTecniche:sco:730										
type	<a href="#">m730:Rettificativo_Type</a>										
facets	<table border="1"> <thead> <tr> <th>Kind</th> <th>Value</th> </tr> </thead> <tbody> <tr> <td>pattern</td> <td>[1-9]</td> </tr> <tr> <td>enumeration</td> <td>1</td> </tr> <tr> <td>enumeration</td> <td>2</td> </tr> <tr> <td>enumeration</td> <td>3</td> </tr> </tbody> </table>	Kind	Value	pattern	[1-9]	enumeration	1	enumeration	2	enumeration	3
Kind	Value										
pattern	[1-9]										
enumeration	1										
enumeration	2										
enumeration	3										

element **Documento\_730-4/AltriDati/Integrativo**

diagram											
namespace	urn:www.agenziaentrate.gov.it:specificheTecniche:sco:730										
type	<a href="#">m730:Integrativo_Type</a>										
facets	<table border="1"> <thead> <tr> <th>Kind</th> <th>Value</th> </tr> </thead> <tbody> <tr> <td>pattern</td> <td>[1-9]</td> </tr> <tr> <td>enumeration</td> <td>1</td> </tr> <tr> <td>enumeration</td> <td>2</td> </tr> <tr> <td>enumeration</td> <td>3</td> </tr> </tbody> </table>	Kind	Value	pattern	[1-9]	enumeration	1	enumeration	2	enumeration	3
Kind	Value										
pattern	[1-9]										
enumeration	1										
enumeration	2										
enumeration	3										

element **Documento\_730-4/AltriDati/Annullamento**

diagram					
namespace	urn:www.agenziaentrate.gov.it:specificheTecniche:sco:730				
type	<a href="#">DatoCB_Type</a>				
facets	<table border="1"> <thead> <tr> <th>Kind</th> <th>Value</th> </tr> </thead> <tbody> <tr> <td>pattern</td> <td>[01]</td> </tr> </tbody> </table>	Kind	Value	pattern	[01]
Kind	Value				
pattern	[01]				

element **Documento\_730-4/AltriDati/SpazioDisposizioneUtente**

diagram	
namespace	urn:www.agenziaentrate.gov.it:specificheTecniche:sco:730
type	<a href="#">DatoAN_Type</a>
facets	Kind Value pattern ([0-9A-Z-] \&quot;){1}([ 0-9A-Z&amp;:] ' \- \., / ^*\^\(\)\ À É È Ì Ò Ù Û &quot; \ \\ / +)*

element **Documento\_730-4/AltriDati/SituazioniParticolari**

diagram	
namespace	urn:www.agenziaentrate.gov.it:specificheTecniche:sco:730
type	<a href="#">DatoNP_Type</a>
facets	Kind Value pattern [1-9]{1}[0-9]*

element **Documento\_730-4/DatiContabili730-4**

diagram	
namespace	urn:www.agenziaentrate.gov.it:specificheTecniche:sco:730
children	<a href="#">m730:Ordinario_730-4</a> <a href="#">m730:Integrativo_730-4</a>

element **Documento\_730-4/DatiContabili730-4/Ordinario\_730-4**

diagram	
namespace	urn:www.agenziaentrate.gov.it:specificheTecniche:sco:730
children	<a href="#">m730:ImportiTrattenere</a> <a href="#">m730:ImportiRimborsare</a> <a href="#">m730:Conguaglio</a>

element Documento\_730-4/DatiContabili730-4/Ordinario\_730-4/ImportiTrattenere

<p>diagram</p>	
<p>namespace</p>	<p>urn:www.agenziaentrate.gov.it:specificheTecniche:sco:730</p>
<p>type</p>	<p><a href="#">m730:Importi Trattenere 730-4 Type</a></p>
<p>children</p>	<p><a href="#">m730:IrpefTrattenere</a> <a href="#">m730:AddRegTrattenere</a> <a href="#">m730:AddComTrattenere</a> <a href="#">m730:IrpefPrimaRataTrattenere</a> <a href="#">m730:IrpefSecondaRataTrattenere</a> <a href="#">m730:TassSepAccontoTrattenere</a> <a href="#">m730:AddComAccontoTrattenere</a> <a href="#">m730:PremiRisultatoTrattenere</a> <a href="#">m730:CedolareTrattenere</a> <a href="#">m730:CedolarePrimaRataTrattenere</a> <a href="#">m730:CedolareSecondaRataTrattenere</a></p>

element Documento\_730-4/DatiContabili730-4/Ordinario\_730-4/ImportiRimborsare

<p>diagram</p>	
<p>namespace</p>	<p>urn:www.agenziaentrate.gov.it:specificheTecniche:sco:730</p>
<p>type</p>	<p><a href="#">m730:Importi Rimborsare 730-4 Type</a></p>



children	<a href="#">m730:IrpefRimborsare</a> <a href="#">m730:AddRegRimborsare</a> <a href="#">m730:AddComRimborsare</a> <a href="#">m730:CedolareRimborsare</a>
----------	--

element **Documento\_730-4/DatiContabili730-4/Ordinario\_730-4/Conguaglio**

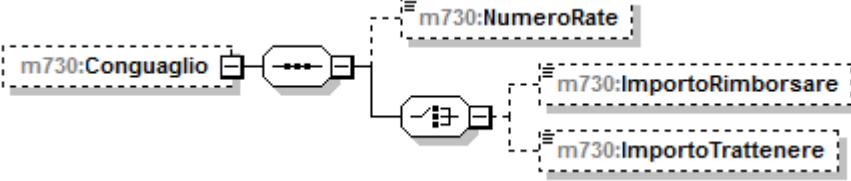
diagram	
namespace	urn:www.agenziaentrate.gov.it:specificheTecniche:sco:730
children	<a href="#">m730:NumeroRate</a> <a href="#">m730:ImportoRimborsare</a> <a href="#">m730:ImportoTrattenere</a>

element **Documento\_730-4/DatiContabili730-4/Ordinario\_730-4/Conguaglio/NumeroRate**

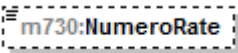
diagram					
namespace	urn:www.agenziaentrate.gov.it:specificheTecniche:sco:730				
type	<a href="#">DatoN1_Type</a>				
facets	<table border="1"> <tr> <td>Kind</td> <td>Value</td> </tr> <tr> <td>pattern</td> <td>[1-9]</td> </tr> </table>	Kind	Value	pattern	[1-9]
Kind	Value				
pattern	[1-9]				

element **Documento\_730-4/DatiContabili730-4/Ordinario\_730-4/Conguaglio/ImportoRimborsare**

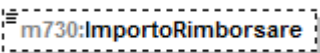
diagram					
namespace	urn:www.agenziaentrate.gov.it:specificheTecniche:sco:730				
type	<a href="#">DatoNP_Type</a>				
facets	<table border="1"> <tr> <td>Kind</td> <td>Value</td> </tr> <tr> <td>pattern</td> <td>[1-9]{1}[0-9]*</td> </tr> </table>	Kind	Value	pattern	[1-9]{1}[0-9]*
Kind	Value				
pattern	[1-9]{1}[0-9]*				

element **Documento\_730-4/DatiContabili730-4/Ordinario\_730-4/Conguaglio/ImportoTrattenere**

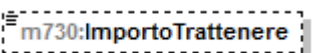
diagram					
namespace	urn:www.agenziaentrate.gov.it:specificheTecniche:sco:730				
type	<a href="#">DatoNP_Type</a>				
facets	<table border="1"> <tr> <td>Kind</td> <td>Value</td> </tr> <tr> <td>pattern</td> <td>[1-9]{1}[0-9]*</td> </tr> </table>	Kind	Value	pattern	[1-9]{1}[0-9]*
Kind	Value				
pattern	[1-9]{1}[0-9]*				

element **Documento\_730-4/DatiContabili730-4/Integrativo\_730-4**

diagram	
namespace	urn:www.agenziaentrate.gov.it:specificheTecniche:sco:730
children	<a href="#">m730:ImportiRimborsare</a>

element **Documento\_730-4/DatiContabili730-4/Integrativo\_730-4/ImportiRimborsare**

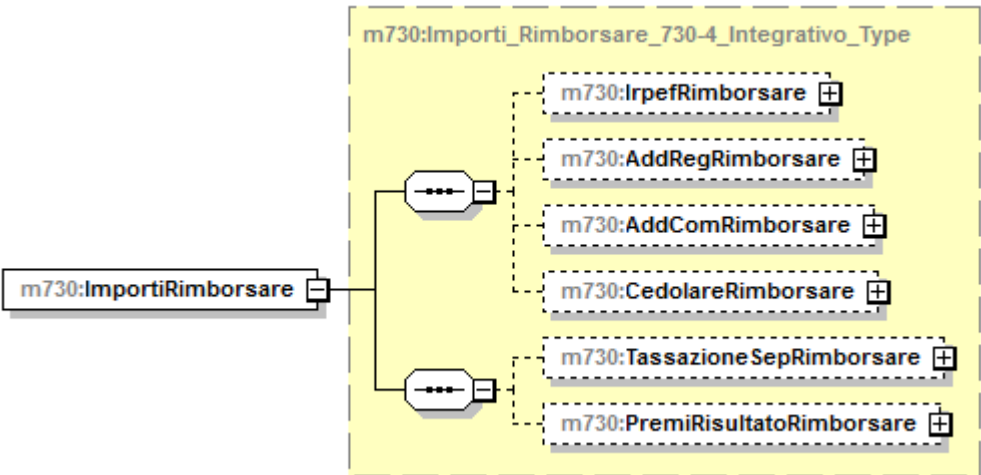
diagram	
namespace	urn:www.agenziaentrate.gov.it:specificheTecniche:sco:730
type	<a href="#">m730:Importi Rimborsare 730-4 Integrativo Type</a>
children	<a href="#">m730:IrpefRimborsare</a> <a href="#">m730:AddRegRimborsare</a> <a href="#">m730:AddComRimborsare</a> <a href="#">m730:CedolareRimborsare</a> <a href="#">m730:TassazioneSepRimborsare</a> <a href="#">m730:PremiRisultatoRimborsare</a>

complexType Documento\_730\_Type

diagram					
namespace	urn:www.agenziaentrate.gov.it:specificheTecniche:sco:730				
type	extension of <a href="#">Documento_Type</a>				
children	<a href="#">m730:DichiarazioneDich</a> <a href="#">m730:DichiarazioneCon</a> <a href="#">m730:AltriDati</a> <a href="#">m730:Sostituto</a> <a href="#">m730:Mod730DipendentiSenzaSostituto</a> <a href="#">m730:SoggettoAssFiscaleDoc</a> <a href="#">m730:Documento_730-4</a> <a href="#">m730:EsitiContabili</a> <a href="#">m730:DatiRettificati</a>				
attributes	Name	Type	Use	Default	Fixed
	<a href="#">identificativo</a>	<a href="#">Identificativo_Type</a>	required		

element Documento\_730\_Type/DichiarazioneDich

diagram					
namespace	urn:www.agenziaentrate.gov.it:specificheTecniche:sco:730				

type	<a href="#">m730:Dichiarazione Dich Type</a>
children	<a href="#">m730:Frontespizio</a> <a href="#">m730:DatiContabili</a> <a href="#">m730:FuoriAssistenza</a> <a href="#">m730:Scelte</a>

element **Documento\_730\_Type/DichiarazioneCon**

diagram	
namespace	urn:www.agenziaentrate.gov.it:specificheTecniche:sco:730
type	<a href="#">m730:Dichiarazione Con Type</a>
children	<a href="#">m730:Frontespizio</a> <a href="#">m730:DatiContabili</a> <a href="#">m730:FuoriAssistenzaQuadri</a> <a href="#">m730:Scelte</a>

element **Documento\_730\_Type/AltriDati**

diagram	
namespace	urn:www.agenziaentrate.gov.it:specificheTecniche:sco:730

children	<a href="#">m730:FlagConferma</a> <a href="#">m730:FlagAssenzaDati730-4</a> <a href="#">m730:FlagCfErratoDicTrasmessa</a> <a href="#">m730:Rettificativo</a> <a href="#">m730:Integrativo</a> <a href="#">m730:CfProduttoreSoftware</a> <a href="#">m730:SpazioDisposizioneUtente</a> <a href="#">m730:DichiarazioneCongiunta</a> <a href="#">m730:SituazioniParticolari</a> <a href="#">m730:Mod730SenzaSostituto</a> <a href="#">m730:ComunicazioneDatiRettificati</a> <a href="#">m730:SostCafProfessNonDelegato</a>
----------	---

element **Documento\_730\_Type/AltriDati/FlagConferma**

diagram	
namespace	urn:www.agenziaentrate.gov.it:specificheTecniche:sco:730
type	<a href="#">DatoCB_Type</a>
facets	Kind Value pattern [01]

element **Documento\_730\_Type/AltriDati/FlagAssenzaDati730-4**

diagram	
namespace	urn:www.agenziaentrate.gov.it:specificheTecniche:sco:730
type	<a href="#">DatoCB_Type</a>
facets	Kind Value pattern [01]

element **Documento\_730\_Type/AltriDati/FlagCfErratoDicTrasmessa**

diagram	
namespace	urn:www.agenziaentrate.gov.it:specificheTecniche:sco:730
type	<a href="#">DatoCF_Type</a>
facets	Kind Value pattern [0-9]{11}[[A-Z]{6}[0-9LMNPQRSTUUV]{2}[A-Z]{1}[0-9LMNPQRSTUUV]{2}[A-Z]{1}[0-9LMNPQRSTUUV]{3}[A-Z]{1}

element **Documento\_730\_Type/AltriDati/Rettificativo**

diagram	
namespace	urn:www.agenziaentrate.gov.it:specificheTecniche:sco:730
type	<a href="#">m730:Rettificativo_Type</a>
facets	Kind Value pattern [1-9] enumeration 1 enumeration 2 enumeration 3

element **Documento\_730\_Type/AltriDati/Integrativo**

diagram	 <b>m730:Integrativo</b>										
namespace	urn:www.agenziaentrate.gov.it:specificheTecniche:sco:730										
type	<a href="#">m730:Integrativo_Type</a>										
facets	<table border="1"> <thead> <tr> <th>Kind</th> <th>Value</th> </tr> </thead> <tbody> <tr> <td>pattern</td> <td>[1-9]</td> </tr> <tr> <td>enumeration</td> <td>1</td> </tr> <tr> <td>enumeration</td> <td>2</td> </tr> <tr> <td>enumeration</td> <td>3</td> </tr> </tbody> </table>	Kind	Value	pattern	[1-9]	enumeration	1	enumeration	2	enumeration	3
Kind	Value										
pattern	[1-9]										
enumeration	1										
enumeration	2										
enumeration	3										

element **Documento\_730\_Type/AltriDati/CfProduttoreSoftware**

diagram	 <b>m730:CfProduttore Software</b>				
namespace	urn:www.agenziaentrate.gov.it:specificheTecniche:sco:730				
type	<a href="#">DatoCF_Type</a>				
facets	<table border="1"> <thead> <tr> <th>Kind</th> <th>Value</th> </tr> </thead> <tbody> <tr> <td>pattern</td> <td>[0-9]{11}[A-Z]{6}[0-9LMNPQRSTUW]{2}[A-Z]{1}[0-9LMNPQRSTUW]{2}[A-Z]{1}[0-9LMNPQRSTUW]{3}[A-Z]{1}</td> </tr> </tbody> </table>	Kind	Value	pattern	[0-9]{11}[A-Z]{6}[0-9LMNPQRSTUW]{2}[A-Z]{1}[0-9LMNPQRSTUW]{2}[A-Z]{1}[0-9LMNPQRSTUW]{3}[A-Z]{1}
Kind	Value				
pattern	[0-9]{11}[A-Z]{6}[0-9LMNPQRSTUW]{2}[A-Z]{1}[0-9LMNPQRSTUW]{2}[A-Z]{1}[0-9LMNPQRSTUW]{3}[A-Z]{1}				

element **Documento\_730\_Type/AltriDati/SpazioDisposizioneUtente**

diagram	 <b>m730:SpazioDisposizioneUtente</b>				
namespace	urn:www.agenziaentrate.gov.it:specificheTecniche:sco:730				
type	<a href="#">DatoAN_Type</a>				
facets	<table border="1"> <thead> <tr> <th>Kind</th> <th>Value</th> </tr> </thead> <tbody> <tr> <td>pattern</td> <td>([0-9A-Z- &amp;quot;]{1})([ 0-9A-Z&amp;amp;:] ' - \., / ° °\(\) \) À É È Ì Ò Ù Û &amp;quot; \\ / +)*</td> </tr> </tbody> </table>	Kind	Value	pattern	([0-9A-Z- &quot;]{1})([ 0-9A-Z&amp;:] ' - \., / ° °\(\) \) À É È Ì Ò Ù Û &quot; \\ / +)*
Kind	Value				
pattern	([0-9A-Z- &quot;]{1})([ 0-9A-Z&amp;:] ' - \., / ° °\(\) \) À É È Ì Ò Ù Û &quot; \\ / +)*				

element **Documento\_730\_Type/AltriDati/DichiarazioneCongiunta**

diagram	 <b>m730:DichiarazioneCongiunta</b>				
namespace	urn:www.agenziaentrate.gov.it:specificheTecniche:sco:730				
type	<a href="#">DatoCB_Type</a>				
facets	<table border="1"> <thead> <tr> <th>Kind</th> <th>Value</th> </tr> </thead> <tbody> <tr> <td>pattern</td> <td>[01]</td> </tr> </tbody> </table>	Kind	Value	pattern	[01]
Kind	Value				
pattern	[01]				

element **Documento\_730\_Type/AltriDati/SituazioniParticolari**

diagram	 <b>m730:SituazioniParticolari</b>
namespace	urn:www.agenziaentrate.gov.it:specificheTecniche:sco:730
type	<a href="#">DatoNP_Type</a>

facets	Kind	Value
	pattern	[1-9]{1}[0-9]*

**element Documento\_730\_Type/AltriDati/Mod730SenzaSostituto**

diagram		
namespace	urn:www.agenziaentrate.gov.it:specificheTecniche:sco:730	
type	restriction of <a href="#">DatoAN_Type</a>	
facets	Kind	Value
	pattern	(([0-9A-Z\-\ ]&quot;){1}([ 0-9A-Z&amp;#92;]\ \-\ \.\ , / \° \^ \( \) \À \È \É \  \Ò \Ù \Ü &quot; \ \\ \ +)*
	enumeration	A

**element Documento\_730\_Type/AltriDati/ComunicazioneDatiRettificati**

diagram		
namespace	urn:www.agenziaentrate.gov.it:specificheTecniche:sco:730	
type	<a href="#">DatoCB_Type</a>	
facets	Kind	Value
	pattern	[01]

**element Documento\_730\_Type/AltriDati/SostCafProfessNonDelegato**

diagram		
namespace	urn:www.agenziaentrate.gov.it:specificheTecniche:sco:730	
type	<a href="#">DatoCB_Type</a>	
facets	Kind	Value
	pattern	[01]

element **Documento\_730\_Type/Sostituto**

diagram	
namespace	urn:www.agenziaentrate.gov.it:specificheTecniche:sco:730
type	<a href="#">m730:Sostituto_Type</a>
children	<a href="#">m730:CodiceFiscale</a> <a href="#">m730:DatiAnagraficiPF</a> <a href="#">m730:DenominazionePNF</a> <a href="#">m730:Residenza</a> <a href="#">m730:Fax</a> <a href="#">m730:CodiceSede</a>

element **Documento\_730\_Type/Mod730DipendentiSenzaSostituto**

diagram					
namespace	urn:www.agenziaentrate.gov.it:specificheTecniche:sco:730				
type	<a href="#">DatoCB_Type</a>				
facets	<table border="1"> <thead> <tr> <th>Kind</th> <th>Value</th> </tr> </thead> <tbody> <tr> <td>pattern</td> <td>[01]</td> </tr> </tbody> </table>	Kind	Value	pattern	[01]
Kind	Value				
pattern	[01]				



element **Documento\_730\_Type/SoggettoAssFiscaleDoc**

diagram	
namespace	urn:www.agenziaentrate.gov.it:specificheTecniche:sco:730
type	<a href="#">m730:Soggetto_Assistenza_Fiscale_Doc_Type</a>
children	<a href="#">m730:DataConsegna</a> <a href="#">m730:TipologiaSoggettoAssFisc</a> <a href="#">m730:SostitutoCF</a> <a href="#">m730:DatiCafDoc</a> <a href="#">m730:DatiProfessionistaDoc</a> <a href="#">m730:DatiAssociazioneDoc</a> <a href="#">m730:AgenziaEntrate</a>

element **Documento\_730\_Type/Documento\_730-4**

diagram	
namespace	urn:www.agenziaentrate.gov.it:specificheTecniche:sco:730
type	<a href="#">m730:Documento_730-4</a>
children	<a href="#">m730:DatiAnagraficiDichiarante</a> <a href="#">m730:Sostituto</a> <a href="#">m730:SoggettoAssFiscale730-4</a> <a href="#">m730:AltriDati</a> <a href="#">m730:DatiContabili730-4</a>

element **Documento\_730\_Type/EsitiContabili**

diagram	<p>The diagram shows a container element <b>m730:EsitiContabili</b> on the left, connected to a central connector. To the right, three sub-elements are listed: <b>m730:Conguaglio</b>, <b>m730:Mod730Integrativo</b>, and <b>m730:VersamentiF24</b>. Each sub-element has a small square icon with a plus sign, indicating it is a complex or optional element.</p>
namespace	urn:www.agenziaentrate.gov.it:specificheTecniche:sco:730
children	<a href="#">m730:Conguaglio</a> <a href="#">m730:Mod730Integrativo</a> <a href="#">m730:VersamentiF24</a>

element **Documento\_730\_Type/EsitiContabili/Conguaglio**

diagram	<p>The diagram shows a container element <b>m730:Conguaglio</b> on the left, connected to a central connector. To the right, a large yellow-shaded box labeled <b>m730:Conguaglio_Type</b> contains several sub-elements: <b>m730:NumeroRate</b>, <b>m730:ImportoTrattenutoSaldo</b>, <b>m730:ImportoTrattenutoAcconto</b>, <b>m730:ImportoDaVersareF24Saldo</b>, <b>m730:ImportoDaVersareF24Acc...</b>, <b>m730:ImportoRimborsato</b>, <b>m730:ImportoRimborsatoAgenzia</b>, and <b>m730:OpzioneInformativa</b>. Each sub-element has a small square icon with horizontal lines, indicating it is a simple element.</p>
namespace	urn:www.agenziaentrate.gov.it:specificheTecniche:sco:730
type	<a href="#">m730:Conguaglio_Type</a>
children	<a href="#">m730:NumeroRate</a> <a href="#">m730:ImportoTrattenutoSaldo</a> <a href="#">m730:ImportoTrattenutoAcconto</a> <a href="#">m730:ImportoDaVersareF24Saldo</a> <a href="#">m730:ImportoDaVersareF24Acconto</a> <a href="#">m730:ImportoRimborsato</a> <a href="#">m730:ImportoRimborsatoAgenzia</a> <a href="#">m730:OpzioneInformativa</a>

element **Documento\_730\_Type/EsitiContabili/Mod730Integrativo**

<p>diagram</p>	
<p>namespace</p>	<p>urn:www.agenziaentrato.gov.it:specificheTecniche:sco:730</p>
<p>type</p>	<p><a href="#">m730:Mod730_Integrativo_Type</a></p>
<p>children</p>	<p><a href="#">m730:ImportiRimborsare</a> <a href="#">m730:ImportoRimborsato</a> <a href="#">m730:ImportoRimborsatoAgenzia</a></p>

element **Documento\_730\_Type/EsitiContabili/VersamentiF24**

<p>diagram</p>	
<p>namespace</p>	<p>urn:www.agenziaentrate.gov.it:specificheTecniche:sco:730</p>
<p>type</p>	<p><a href="#">m730:Versamenti_F24_Type</a></p>
<p>children</p>	<p><a href="#">m730:F24DebitoIrpef</a> <a href="#">m730:F24DebitoCodRegione</a> <a href="#">m730:F24DebitoAddReg</a> <a href="#">m730:F24DebitoCodComune</a> <a href="#">m730:F24DebitoAddCom</a> <a href="#">m730:F24DebitoPrimaRataAcclrpef</a> <a href="#">m730:F24DebitoAccontoTassSep</a> <a href="#">m730:F24DebitoCodComuneAcconto</a> <a href="#">m730:F24DebitoAccontoAddCom</a> <a href="#">m730:F24DebitoImpostaSost</a> <a href="#">m730:F24DebitoCedolare</a> <a href="#">m730:F24DebitoPrimaRataAccCedolare</a> <a href="#">m730:F24DebitoCodRegioneConiuge</a></p>

	<a href="#">m730:F24DebitoAddRegConiuge</a> <a href="#">m730:F24DebitoCodComuneConiuge</a> <a href="#">m730:F24DebitoAddComConiuge</a> <a href="#">m730:F24DebitoCodComuneAccontoConiuge</a> <a href="#">m730:F24DebitoAccontoAddComConiuge</a> <a href="#">m730:F24DebitoSecondaRataAcclrpef</a> <a href="#">m730:F24DebitoSecondaRataAccCedolare</a>
--	--

element **Documento\_730\_Type/DatiRettificati**

diagram	
namespace	urn:www.agenziaentrate.gov.it:specificheTecniche:sco:730
type	<a href="#">m730:Dati_Rettificati_Type</a>
children	<a href="#">m730:Modulo</a>

complexType **Domanda\_Accatamento\_Type**

diagram	
namespace	urn:www.agenziaentrate.gov.it:specificheTecniche:sco:730
children	<a href="#">m730:Data</a> <a href="#">m730:Numero</a> <a href="#">m730:ProvinciaUfficio</a>

element **Domanda\_Accatamento\_Type/Data**

diagram					
namespace	urn:www.agenziaentrate.gov.it:specificheTecniche:sco:730				
type	<a href="#">DatoDT_Type</a>				
facets	<table border="1"> <thead> <tr> <th>Kind</th> <th>Value</th> </tr> </thead> <tbody> <tr> <td>pattern</td> <td>(((0[1-9][12][0-9]3[01])(0[13578]10[12](\d{4})) ((0[1-9][12][0-9]30)(0[469]11)(\d{4})) ((0[1-9]1[0-9]2[0-8])(02)(\d{4})) ((29)(02)([02468][048]00)) ((29)(02)([13579][26]00)) ((29)(02)([0-9][0-9][0]48)) ((29)(02)([0-9][0-9][2468][048])) ((29)(02)([0-9][0-9][13579][26]))))</td> </tr> </tbody> </table>	Kind	Value	pattern	(((0[1-9][12][0-9]3[01])(0[13578]10[12](\d{4})) ((0[1-9][12][0-9]30)(0[469]11)(\d{4})) ((0[1-9]1[0-9]2[0-8])(02)(\d{4})) ((29)(02)([02468][048]00)) ((29)(02)([13579][26]00)) ((29)(02)([0-9][0-9][0]48)) ((29)(02)([0-9][0-9][2468][048])) ((29)(02)([0-9][0-9][13579][26]))))
Kind	Value				
pattern	(((0[1-9][12][0-9]3[01])(0[13578]10[12](\d{4})) ((0[1-9][12][0-9]30)(0[469]11)(\d{4})) ((0[1-9]1[0-9]2[0-8])(02)(\d{4})) ((29)(02)([02468][048]00)) ((29)(02)([13579][26]00)) ((29)(02)([0-9][0-9][0]48)) ((29)(02)([0-9][0-9][2468][048])) ((29)(02)([0-9][0-9][13579][26]))))				

element **Domanda\_Accatamento\_Type/Numero**

diagram	
namespace	urn:www.agenziaentrate.gov.it:specificheTecniche:sco:730
type	<a href="#">DatoAN_Type</a>

facets	Kind	Value
	pattern	([0-9A-Z-] \&quot;){1}([ 0-9A-Z&amp;:] ' \" . , / ^\\(\\) À É È Ì Ò Ù Ú &quot; \\ \\ \\+)*

**element Domanda\_Accatastamento\_Type/ProvinciaUfficio**

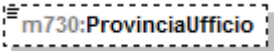
diagram	
namespace	urn:www.agenziaentrate.gov.it:specificheTecniche:sco:730
type	<a href="#">PN_Type</a>

**complexType Domicilio\_Fiscale\_Type**

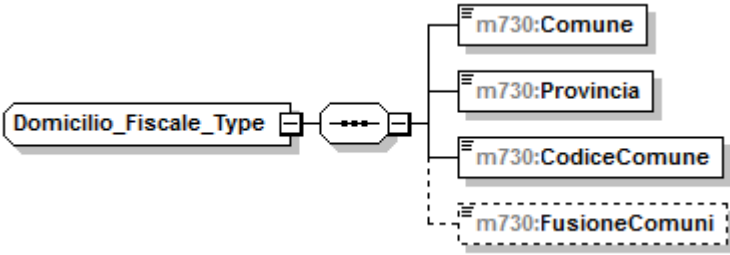
diagram	
namespace	urn:www.agenziaentrate.gov.it:specificheTecniche:sco:730
children	<a href="#">m730:Comune</a> <a href="#">m730:Provincia</a> <a href="#">m730:CodiceComune</a> <a href="#">m730:FusioneComuni</a>

**element Domicilio\_Fiscale\_Type/Comune**

diagram		
namespace	urn:www.agenziaentrate.gov.it:specificheTecniche:sco:730	
type	<a href="#">DatoAN_Type</a>	
facets	Kind	Value
	pattern	([0-9A-Z-] \&quot;){1}([ 0-9A-Z&amp;:] ' \" . , / ^\\(\\) À É È Ì Ò Ù Ú &quot; \\ \\ \\+)*

**element Domicilio\_Fiscale\_Type/Provincia**

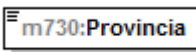
diagram	
namespace	urn:www.agenziaentrate.gov.it:specificheTecniche:sco:730
type	<a href="#">PR_Type</a>

**element Domicilio\_Fiscale\_Type/CodiceComune**

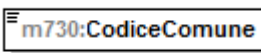
diagram	
---------	---

namespace	urn:www.agenziaentrate.gov.it:specificheTecniche:sco:730
type	<a href="#">DatoAN_Type</a>
facets	Kind Value pattern ([0-9A-Z\-\]\&quot;){1}([ 0-9A-Z&amp;:] ' \"- \. , / ° \"^\"(\ \\) À É Ê Ì Ò Ù Û &quot; \\\" \\+)*

element **Domicilio\_Fiscale\_Type/FusioneComuni**

diagram	
namespace	urn:www.agenziaentrate.gov.it:specificheTecniche:sco:730
type	<a href="#">DatoAN_Type</a>
facets	Kind Value pattern ([0-9A-Z\-\]\&quot;){1}([ 0-9A-Z&amp;:] ' \"- \. , / ° \"^\"(\ \\) À É Ê Ì Ò Ù Û &quot; \\\" \\+)*

complexType **Domicilio\_Sogg\_Ass\_Fiscale\_Type**

diagram	
namespace	urn:www.agenziaentrate.gov.it:specificheTecniche:sco:730
children	<a href="#">m730:Comune</a> <a href="#">m730:Provincia</a> <a href="#">m730:CodiceComune</a> <a href="#">m730:Cap</a> <a href="#">m730:Indirizzo</a> <a href="#">m730:Telefono</a> <a href="#">m730:FAX</a> <a href="#">m730:Email</a>

element **Domicilio\_Sogg\_Ass\_Fiscale\_Type/Comune**

diagram	
namespace	urn:www.agenziaentrate.gov.it:specificheTecniche:sco:730
type	<a href="#">DatoAN_Type</a>
facets	Kind Value pattern ([0-9A-Z\-\]\&quot;){1}([ 0-9A-Z&amp;:] ' \"- \. , / ° \"^\"(\ \\) À É Ê Ì Ò Ù Û &quot; \\\" \\+)*

element **Domicilio\_Sogg\_Ass\_Fiscale\_Type/Provincia**

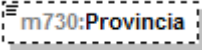
diagram	
namespace	urn:www.agenziaentrate.gov.it:specificheTecniche:sco:730
type	<a href="#">PR_Type</a>

element **Domicilio\_Sogg\_Ass\_Fiscale\_Type/CodiceComune**

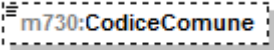
diagram					
namespace	urn:www.agenziaentrate.gov.it:specificheTecniche:sco:730				
type	<a href="#">DatoAN_Type</a>				
facets	<table border="0"> <tr> <td>Kind</td> <td>Value</td> </tr> <tr> <td>pattern</td> <td>(([0-9A-Z\-\]]&amp;quot;){1}([ 0-9A-Z&amp;amp;:] [\-\.\, /°\^\(\)\ À É È Ì Ò Ù Û]&amp;quot; \ \ \ +)*</td> </tr> </table>	Kind	Value	pattern	(([0-9A-Z\-\]]&quot;){1}([ 0-9A-Z&amp;:] [\-\.\, /°\^\(\)\ À É È Ì Ò Ù Û]&quot; \ \ \ +)*
Kind	Value				
pattern	(([0-9A-Z\-\]]&quot;){1}([ 0-9A-Z&amp;:] [\-\.\, /°\^\(\)\ À É È Ì Ò Ù Û]&quot; \ \ \ +)*				

element **Domicilio\_Sogg\_Ass\_Fiscale\_Type/Cap**

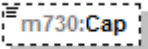
diagram					
namespace	urn:www.agenziaentrate.gov.it:specificheTecniche:sco:730				
type	<a href="#">DatoAN_Type</a>				
facets	<table border="0"> <tr> <td>Kind</td> <td>Value</td> </tr> <tr> <td>pattern</td> <td>(([0-9A-Z\-\]]&amp;quot;){1}([ 0-9A-Z&amp;amp;:] [\-\.\, /°\^\(\)\ À É È Ì Ò Ù Û]&amp;quot; \ \ \ +)*</td> </tr> </table>	Kind	Value	pattern	(([0-9A-Z\-\]]&quot;){1}([ 0-9A-Z&amp;:] [\-\.\, /°\^\(\)\ À É È Ì Ò Ù Û]&quot; \ \ \ +)*
Kind	Value				
pattern	(([0-9A-Z\-\]]&quot;){1}([ 0-9A-Z&amp;:] [\-\.\, /°\^\(\)\ À É È Ì Ò Ù Û]&quot; \ \ \ +)*				

element **Domicilio\_Sogg\_Ass\_Fiscale\_Type/Indirizzo**

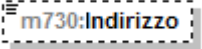
diagram					
namespace	urn:www.agenziaentrate.gov.it:specificheTecniche:sco:730				
type	<a href="#">DatoAN_Type</a>				
facets	<table border="0"> <tr> <td>Kind</td> <td>Value</td> </tr> <tr> <td>pattern</td> <td>(([0-9A-Z\-\]]&amp;quot;){1}([ 0-9A-Z&amp;amp;:] [\-\.\, /°\^\(\)\ À É È Ì Ò Ù Û]&amp;quot; \ \ \ +)*</td> </tr> </table>	Kind	Value	pattern	(([0-9A-Z\-\]]&quot;){1}([ 0-9A-Z&amp;:] [\-\.\, /°\^\(\)\ À É È Ì Ò Ù Û]&quot; \ \ \ +)*
Kind	Value				
pattern	(([0-9A-Z\-\]]&quot;){1}([ 0-9A-Z&amp;:] [\-\.\, /°\^\(\)\ À É È Ì Ò Ù Û]&quot; \ \ \ +)*				

element **Domicilio\_Sogg\_Ass\_Fiscale\_Type/Telefono**

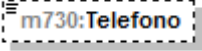
diagram					
namespace	urn:www.agenziaentrate.gov.it:specificheTecniche:sco:730				
type	<a href="#">DatoAN_Type</a>				
facets	<table border="0"> <tr> <td>Kind</td> <td>Value</td> </tr> <tr> <td>pattern</td> <td>(([0-9A-Z\-\]]&amp;quot;){1}([ 0-9A-Z&amp;amp;:] [\-\.\, /°\^\(\)\ À É È Ì Ò Ù Û]&amp;quot; \ \ \ +)*</td> </tr> </table>	Kind	Value	pattern	(([0-9A-Z\-\]]&quot;){1}([ 0-9A-Z&amp;:] [\-\.\, /°\^\(\)\ À É È Ì Ò Ù Û]&quot; \ \ \ +)*
Kind	Value				
pattern	(([0-9A-Z\-\]]&quot;){1}([ 0-9A-Z&amp;:] [\-\.\, /°\^\(\)\ À É È Ì Ò Ù Û]&quot; \ \ \ +)*				



element **Domicilio\_Sogg\_Ass\_Fiscale\_Type/FAX**

diagram	
namespace	urn:www.agenziaentrate.gov.it:specificheTecniche:sco:730
type	<a href="#">DatoAN_Type</a>
facets	Kind Value pattern (([0-9A-Z-] \&quot;){1}([ 0-9A-Z&amp;:] ' - \., / "^\(\)\) À É È Ì Ò Ù Û &quot; \ \\ / +)*

element **Domicilio\_Sogg\_Ass\_Fiscale\_Type/Email**

diagram	
namespace	urn:www.agenziaentrate.gov.it:specificheTecniche:sco:730
type	<a href="#">DatoEM_Type</a>
facets	Kind Value pattern [a-zA-Z0-9._%!\-'\&quot;?^~=]+@[a-zA-Z0-9.\-]+\.[a-zA-Z]{2,4}

complexType **Eccedenze\_Oltre\_Anno\_Type**

diagram	
namespace	urn:www.agenziaentrate.gov.it:specificheTecniche:sco:730
children	<a href="#">m730:Anno</a> <a href="#">m730:Irpef</a> <a href="#">m730:SostitutivaQuadroRT</a> <a href="#">m730:CedolareSecca</a> <a href="#">m730:CodiceRegione</a> <a href="#">m730:AddRegionaleIrpef</a> <a href="#">m730:CodiceCatastaleComune</a> <a href="#">m730:AddComunaleIrpef</a> <a href="#">m730:ImpostaSostitutiva</a>

element **Eccedenze\_Oltre\_Anno\_Type/Anno**

diagram	
---------	--

namespace	urn:www.agenziaentrate.gov.it:specificheTecniche:sco:730
type	<a href="#">DatoDA Type</a>
facets	Kind Value pattern (18 19 20)[0-9]{2}

#### element **Eccedenze\_Oltre\_Anno\_Type/lrpef**

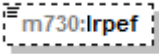
diagram	
namespace	urn:www.agenziaentrate.gov.it:specificheTecniche:sco:730
type	<a href="#">DatoNP Type</a>
facets	Kind Value pattern [1-9]{1}[0-9]*

#### element **Eccedenze\_Oltre\_Anno\_Type/SostitutivaQuadroRT**

diagram	
namespace	urn:www.agenziaentrate.gov.it:specificheTecniche:sco:730
type	<a href="#">DatoNP Type</a>
facets	Kind Value pattern [1-9]{1}[0-9]*

#### element **Eccedenze\_Oltre\_Anno\_Type/CedolareSecca**

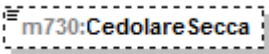
diagram	
namespace	urn:www.agenziaentrate.gov.it:specificheTecniche:sco:730
type	<a href="#">DatoNP Type</a>
facets	Kind Value pattern [1-9]{1}[0-9]*

#### element **Eccedenze\_Oltre\_Anno\_Type/CodiceRegione**

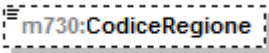
diagram	
namespace	urn:www.agenziaentrate.gov.it:specificheTecniche:sco:730
type	<a href="#">Codice Regione Type</a>
facets	Kind Value pattern ([0-9A-Z-]]&quot;){1}([ 0-9A-Z&amp;]] [-\., /°\^\(\ )\ À É É ì ò ù Û &quot; \N  \+)* enumeration 1 enumeration 2 enumeration 3 enumeration 4 enumeration 5 enumeration 6 enumeration 7

enumeration	8
enumeration	9
enumeration	10
enumeration	11
enumeration	12
enumeration	13
enumeration	14
enumeration	15
enumeration	16
enumeration	17
enumeration	18
enumeration	19
enumeration	20
enumeration	21

#### element **Eccedenze\_Oltre\_Anno\_Type/AddRegionalelrpef**

diagram					
namespace	urn:www.agenziaentrate.gov.it:specificheTecniche:sco:730				
type	<a href="#">DatoNP_Type</a>				
facets	<table border="1"> <tr><td>Kind</td><td>Value</td></tr> <tr><td>pattern</td><td>[1-9]{1}[0-9]*</td></tr> </table>	Kind	Value	pattern	[1-9]{1}[0-9]*
Kind	Value				
pattern	[1-9]{1}[0-9]*				

#### element **Eccedenze\_Oltre\_Anno\_Type/CodiceCatastaleComune**

diagram					
namespace	urn:www.agenziaentrate.gov.it:specificheTecniche:sco:730				
type	restriction of <a href="#">DatoAN_Type</a>				
facets	<table border="1"> <tr><td>Kind</td><td>Value</td></tr> <tr><td>pattern</td><td>([0-9A-Z-] \&amp;quot;){1}([ 0-9A-Z&amp;amp;:] ' \" \- \., / ^°^°\(\ )\ À È É Ì Ò Ù Û &amp;quot; \\" \+)*</td></tr> </table>	Kind	Value	pattern	([0-9A-Z-] \&quot;){1}([ 0-9A-Z&amp;:] ' \" \- \., / ^°^°\(\ )\ À È É Ì Ò Ù Û &quot; \\" \+)*
Kind	Value				
pattern	([0-9A-Z-] \&quot;){1}([ 0-9A-Z&amp;:] ' \" \- \., / ^°^°\(\ )\ À È É Ì Ò Ù Û &quot; \\" \+)*				

#### element **Eccedenze\_Oltre\_Anno\_Type/AddComunalelrpef**

diagram					
namespace	urn:www.agenziaentrate.gov.it:specificheTecniche:sco:730				
type	<a href="#">DatoNP_Type</a>				
facets	<table border="1"> <tr><td>Kind</td><td>Value</td></tr> <tr><td>pattern</td><td>[1-9]{1}[0-9]*</td></tr> </table>	Kind	Value	pattern	[1-9]{1}[0-9]*
Kind	Value				
pattern	[1-9]{1}[0-9]*				

#### element **Eccedenze\_Oltre\_Anno\_Type/ImpostaSostitutiva**

diagram	
namespace	urn:www.agenziaentrate.gov.it:specificheTecniche:sco:730
type	<a href="#">DatoNP_Type</a>

facets	Kind pattern	Value [1-9]{1}[0-9]*
--------	-----------------	-------------------------

### complexType **Eccedenze\_Type**

diagram	
namespace	urn:www.agenziaentrate.gov.it:specificheTecniche:sco:730
children	<a href="#">m730:lrp ef</a> <a href="#">m730:lrp efCompF24</a> <a href="#">m730:SostitutivaQuadroRT</a> <a href="#">m730:SostitutivaQuadroRTcompF24</a> <a href="#">m730:CedolareSecca</a> <a href="#">m730:CedolareSeccaCompF24</a> <a href="#">m730:CodiceRegione</a> <a href="#">m730:AddRegionalelrp ef</a> <a href="#">m730:AddRegionalelrp efCompF24</a> <a href="#">m730:CodiceCatastaleComune</a> <a href="#">m730:AddComunalelrp ef</a> <a href="#">m730:AddComunalelrp efF24</a> <a href="#">m730:PremioRisultato</a> <a href="#">m730:PremioRisultatoCompF24</a>

### element **Eccedenze\_Type/lrp ef**

diagram		
namespace	urn:www.agenziaentrate.gov.it:specificheTecniche:sco:730	
type	<a href="#">DatoNP_Type</a>	
facets	Kind pattern	Value [1-9]{1}[0-9]*

element **Eccedenze\_Type/lrpefCompF24**

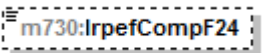
diagram					
namespace	urn:www.agenziaentrate.gov.it:specificheTecniche:sco:730				
type	<a href="#">DatoNP_Type</a>				
facets	<table border="1"> <tr> <td>Kind</td> <td>Value</td> </tr> <tr> <td>pattern</td> <td>[1-9]{1}[0-9]*</td> </tr> </table>	Kind	Value	pattern	[1-9]{1}[0-9]*
Kind	Value				
pattern	[1-9]{1}[0-9]*				

element **Eccedenze\_Type/SostitutivaQuadroRT**

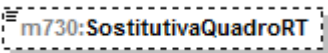
diagram					
namespace	urn:www.agenziaentrate.gov.it:specificheTecniche:sco:730				
type	<a href="#">DatoNP_Type</a>				
facets	<table border="1"> <tr> <td>Kind</td> <td>Value</td> </tr> <tr> <td>pattern</td> <td>[1-9]{1}[0-9]*</td> </tr> </table>	Kind	Value	pattern	[1-9]{1}[0-9]*
Kind	Value				
pattern	[1-9]{1}[0-9]*				

element **Eccedenze\_Type/SostitutivaQuadroRTcompF24**

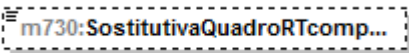
diagram					
namespace	urn:www.agenziaentrate.gov.it:specificheTecniche:sco:730				
type	<a href="#">DatoNP_Type</a>				
facets	<table border="1"> <tr> <td>Kind</td> <td>Value</td> </tr> <tr> <td>pattern</td> <td>[1-9]{1}[0-9]*</td> </tr> </table>	Kind	Value	pattern	[1-9]{1}[0-9]*
Kind	Value				
pattern	[1-9]{1}[0-9]*				

element **Eccedenze\_Type/CedolareSecca**

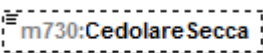
diagram					
namespace	urn:www.agenziaentrate.gov.it:specificheTecniche:sco:730				
type	<a href="#">DatoNP_Type</a>				
facets	<table border="1"> <tr> <td>Kind</td> <td>Value</td> </tr> <tr> <td>pattern</td> <td>[1-9]{1}[0-9]*</td> </tr> </table>	Kind	Value	pattern	[1-9]{1}[0-9]*
Kind	Value				
pattern	[1-9]{1}[0-9]*				

element **Eccedenze\_Type/CedolareSeccaCompF24**

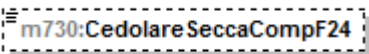
diagram					
namespace	urn:www.agenziaentrate.gov.it:specificheTecniche:sco:730				
type	<a href="#">DatoNP_Type</a>				
facets	<table border="1"> <tr> <td>Kind</td> <td>Value</td> </tr> <tr> <td>pattern</td> <td>[1-9]{1}[0-9]*</td> </tr> </table>	Kind	Value	pattern	[1-9]{1}[0-9]*
Kind	Value				
pattern	[1-9]{1}[0-9]*				

element **Eccedenze\_Type/CodiceRegione**

diagram	 <b>m730:CodiceRegione</b>																																														
namespace	urn:www.agenziaentrate.gov.it:specificheTecniche:sco:730																																														
type	<a href="#">Codice Regione Type</a>																																														
facets	<table border="1"> <thead> <tr> <th>Kind</th> <th>Value</th> </tr> </thead> <tbody> <tr> <td>pattern</td> <td>([0-9A-Z\-\-])&amp;quot;){1}([ 0-9A-Z&amp;amp;:] ["\-\-.,/ °\^*\(\ \)\À È É Ì Ò Ù Ü &amp;quot;:\ \\ \ +)*</td> </tr> <tr><td>enumeration</td><td>1</td></tr> <tr><td>enumeration</td><td>2</td></tr> <tr><td>enumeration</td><td>3</td></tr> <tr><td>enumeration</td><td>4</td></tr> <tr><td>enumeration</td><td>5</td></tr> <tr><td>enumeration</td><td>6</td></tr> <tr><td>enumeration</td><td>7</td></tr> <tr><td>enumeration</td><td>8</td></tr> <tr><td>enumeration</td><td>9</td></tr> <tr><td>enumeration</td><td>10</td></tr> <tr><td>enumeration</td><td>11</td></tr> <tr><td>enumeration</td><td>12</td></tr> <tr><td>enumeration</td><td>13</td></tr> <tr><td>enumeration</td><td>14</td></tr> <tr><td>enumeration</td><td>15</td></tr> <tr><td>enumeration</td><td>16</td></tr> <tr><td>enumeration</td><td>17</td></tr> <tr><td>enumeration</td><td>18</td></tr> <tr><td>enumeration</td><td>19</td></tr> <tr><td>enumeration</td><td>20</td></tr> <tr><td>enumeration</td><td>21</td></tr> </tbody> </table>	Kind	Value	pattern	([0-9A-Z\-\-])&quot;){1}([ 0-9A-Z&amp;:] ["\-\-.,/ °\^*\(\ \)\À È É Ì Ò Ù Ü &quot;:\ \\ \ +)*	enumeration	1	enumeration	2	enumeration	3	enumeration	4	enumeration	5	enumeration	6	enumeration	7	enumeration	8	enumeration	9	enumeration	10	enumeration	11	enumeration	12	enumeration	13	enumeration	14	enumeration	15	enumeration	16	enumeration	17	enumeration	18	enumeration	19	enumeration	20	enumeration	21
Kind	Value																																														
pattern	([0-9A-Z\-\-])&quot;){1}([ 0-9A-Z&amp;:] ["\-\-.,/ °\^*\(\ \)\À È É Ì Ò Ù Ü &quot;:\ \\ \ +)*																																														
enumeration	1																																														
enumeration	2																																														
enumeration	3																																														
enumeration	4																																														
enumeration	5																																														
enumeration	6																																														
enumeration	7																																														
enumeration	8																																														
enumeration	9																																														
enumeration	10																																														
enumeration	11																																														
enumeration	12																																														
enumeration	13																																														
enumeration	14																																														
enumeration	15																																														
enumeration	16																																														
enumeration	17																																														
enumeration	18																																														
enumeration	19																																														
enumeration	20																																														
enumeration	21																																														

element **Eccedenze\_Type/AddRegionalelrpef**

diagram	 <b>m730:AddRegionalelrpef</b>				
namespace	urn:www.agenziaentrate.gov.it:specificheTecniche:sco:730				
type	<a href="#">DatoNP Type</a>				
facets	<table border="1"> <thead> <tr> <th>Kind</th> <th>Value</th> </tr> </thead> <tbody> <tr> <td>pattern</td> <td>[1-9]{1}[0-9]*</td> </tr> </tbody> </table>	Kind	Value	pattern	[1-9]{1}[0-9]*
Kind	Value				
pattern	[1-9]{1}[0-9]*				

element **Eccedenze\_Type/AddRegionalelrpefCompF24**

diagram	 <b>m730:AddRegionalelrpefCompF24</b>				
namespace	urn:www.agenziaentrate.gov.it:specificheTecniche:sco:730				
type	<a href="#">DatoNP Type</a>				
facets	<table border="1"> <thead> <tr> <th>Kind</th> <th>Value</th> </tr> </thead> <tbody> <tr> <td>pattern</td> <td>[1-9]{1}[0-9]*</td> </tr> </tbody> </table>	Kind	Value	pattern	[1-9]{1}[0-9]*
Kind	Value				
pattern	[1-9]{1}[0-9]*				

element **Eccedenze\_Type/CodiceCatastaleComune**

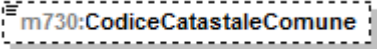
diagram	
namespace	urn:www.agenziaentrate.gov.it:specificheTecniche:sco:730
type	restriction of <a href="#">DatoAN_Type</a>
facets	Kind Value pattern (([0-9A-Z\-\] \&quot;){1}([ 0-9A-Z&amp;:] \-\ \., / \^\ \(\ \)\ À É È Ì Ò Ù Û &quot; \ \\ \ /+)*

element **Eccedenze\_Type/AddComunalelrpef**

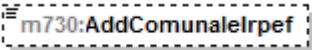
diagram	
namespace	urn:www.agenziaentrate.gov.it:specificheTecniche:sco:730
type	<a href="#">DatoNP_Type</a>
facets	Kind Value pattern [1-9]{1}[0-9]*

element **Eccedenze\_Type/AddComunalelrpefF24**

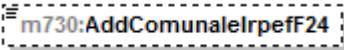
diagram	
namespace	urn:www.agenziaentrate.gov.it:specificheTecniche:sco:730
type	<a href="#">DatoNP_Type</a>
facets	Kind Value pattern [1-9]{1}[0-9]*

element **Eccedenze\_Type/PremioRisultato**

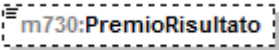
diagram	
namespace	urn:www.agenziaentrate.gov.it:specificheTecniche:sco:730
type	<a href="#">DatoNP_Type</a>
facets	Kind Value pattern [1-9]{1}[0-9]*

element **Eccedenze\_Type/PremioRisultatoCompF24**

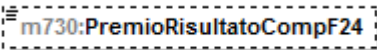
diagram	
namespace	urn:www.agenziaentrate.gov.it:specificheTecniche:sco:730
type	<a href="#">DatoNP_Type</a>
facets	Kind Value pattern [1-9]{1}[0-9]*

complexType **Elemento\_Integrativo\_Type**

diagram	
namespace	urn:www.agenziaentrate.gov.it:specificheTecniche:sco:730
children	<a href="#">m730:lrpef</a> <a href="#">m730:AddizionaleRegionalelrpef</a> <a href="#">m730:AddComunalelrpef</a> <a href="#">m730:CedolareSecca</a>

element **Elemento\_Integrativo\_Type/lrpef**

diagram					
namespace	urn:www.agenziaentrate.gov.it:specificheTecniche:sco:730				
type	<a href="#">DatoNP_Type</a>				
facets	<table border="1"> <thead> <tr> <th>Kind</th> <th>Value</th> </tr> </thead> <tbody> <tr> <td>pattern</td> <td>[1-9]{1}[0-9]*</td> </tr> </tbody> </table>	Kind	Value	pattern	[1-9]{1}[0-9]*
Kind	Value				
pattern	[1-9]{1}[0-9]*				

element **Elemento\_Integrativo\_Type/AddizionaleRegionalelrpef**

diagram					
namespace	urn:www.agenziaentrate.gov.it:specificheTecniche:sco:730				
type	<a href="#">DatoNP_Type</a>				
facets	<table border="1"> <thead> <tr> <th>Kind</th> <th>Value</th> </tr> </thead> <tbody> <tr> <td>pattern</td> <td>[1-9]{1}[0-9]*</td> </tr> </tbody> </table>	Kind	Value	pattern	[1-9]{1}[0-9]*
Kind	Value				
pattern	[1-9]{1}[0-9]*				

element **Elemento\_Integrativo\_Type/AddComunalelrpef**

diagram					
namespace	urn:www.agenziaentrate.gov.it:specificheTecniche:sco:730				
type	<a href="#">DatoNP_Type</a>				
facets	<table border="1"> <thead> <tr> <th>Kind</th> <th>Value</th> </tr> </thead> <tbody> <tr> <td>pattern</td> <td>[1-9]{1}[0-9]*</td> </tr> </tbody> </table>	Kind	Value	pattern	[1-9]{1}[0-9]*
Kind	Value				
pattern	[1-9]{1}[0-9]*				

element **Elemento\_Integrativo\_Type/CedolareSecca**

diagram	
---------	--



namespace	urn:www.agenziaentrate.gov.it:specificheTecniche:sco:730
type	<a href="#">DatoNP_Type</a>
facets	Kind Value pattern [1-9]{1}[0-9]*

### complexType **Esenzione\_Add\_Comunale\_Type**

diagram	
namespace	urn:www.agenziaentrate.gov.it:specificheTecniche:sco:730
children	<a href="#">m730:SogliaEsenzioneSaldo</a> <a href="#">m730:SogliaEsenzioneAcconto</a>

### element **Esenzione\_Add\_Comunale\_Type/SogliaEsenzioneSaldo**

diagram	
namespace	urn:www.agenziaentrate.gov.it:specificheTecniche:sco:730
type	<a href="#">m730:Soglie_Esenzione_Type</a>
children	<a href="#">m730:SogliaEsenzione</a> <a href="#">m730:EsenzioneTotale</a>

### element **Esenzione\_Add\_Comunale\_Type/SogliaEsenzioneAcconto**

diagram	
namespace	urn:www.agenziaentrate.gov.it:specificheTecniche:sco:730
type	<a href="#">m730:Soglie_Esenzione_Type</a>
children	<a href="#">m730:SogliaEsenzione</a> <a href="#">m730:EsenzioneTotale</a>

complexType **Esenzione\_Bonus\_Type**

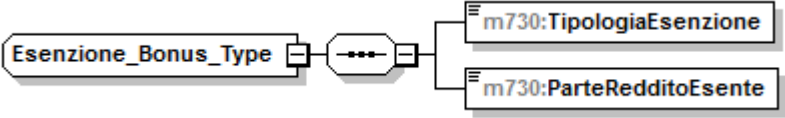
diagram	
namespace	urn:www.agenziaentrate.gov.it:specificheTecniche:sco:730
children	<a href="#">m730:TipologiaEsenzione</a> <a href="#">m730:ParteRedditoEsente</a>

element **Esenzione\_Bonus\_Type/TipologiaEsenzione**

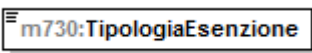
diagram									
namespace	urn:www.agenziaentrate.gov.it:specificheTecniche:sco:730								
type	restriction of <a href="#">DatoN1_Type</a>								
facets	<table border="1"> <thead> <tr> <th>Kind</th> <th>Value</th> </tr> </thead> <tbody> <tr> <td>pattern</td> <td>[1-9]</td> </tr> <tr> <td>enumeration</td> <td>1</td> </tr> <tr> <td>enumeration</td> <td>2</td> </tr> </tbody> </table>	Kind	Value	pattern	[1-9]	enumeration	1	enumeration	2
Kind	Value								
pattern	[1-9]								
enumeration	1								
enumeration	2								

element **Esenzione\_Bonus\_Type/ParteRedditoEsente**

diagram					
namespace	urn:www.agenziaentrate.gov.it:specificheTecniche:sco:730				
type	<a href="#">DatoNP_Type</a>				
facets	<table border="1"> <thead> <tr> <th>Kind</th> <th>Value</th> </tr> </thead> <tbody> <tr> <td>pattern</td> <td>[1-9]{1}[0-9]*</td> </tr> </tbody> </table>	Kind	Value	pattern	[1-9]{1}[0-9]*
Kind	Value				
pattern	[1-9]{1}[0-9]*				

complexType **Esito\_Liquidazione\_Type**

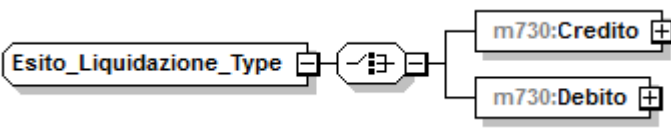
diagram	
namespace	urn:www.agenziaentrate.gov.it:specificheTecniche:sco:730
children	<a href="#">m730:Credito</a> <a href="#">m730:Debito</a>

element **Esito\_Liquidazione\_Type/Credito**

diagram	
namespace	urn:www.agenziaentrate.gov.it:specificheTecniche:sco:730
type	<a href="#">m730:Credito_Type</a>
children	<a href="#">m730:NonRimborsabile</a> <a href="#">m730:Credito</a> <a href="#">m730:CreditoF24</a> <a href="#">m730:CreditoRimborso</a>

element **Esito\_Liquidazione\_Type/Debito**

diagram	
namespace	urn:www.agenziaentrate.gov.it:specificheTecniche:sco:730
type	<a href="#">m730:Debito_Type</a>
children	<a href="#">m730:NonVersare</a> <a href="#">m730:ImportoDaTrattenere</a>

complexType **Fabbricato\_Agev\_Type**

diagram	
namespace	urn:www.agenziaentrate.gov.it:specificheTecniche:sco:730
children	<a href="#">m730:NumeroRigoRiferimento</a> <a href="#">m730:NumModuloRiferimento</a> <a href="#">m730:DatiContratto</a> <a href="#">m730:CasellaInf30Giorni</a> <a href="#">m730:AnnoDichiarazioneIcilmu</a>

element **Fabbricato\_Agev\_Type/NumeroRigoRiferimento**

diagram																									
namespace	urn:www.agenziaentrate.gov.it:specificheTecniche:sco:730																								
type	<a href="#">m730:Fabbricato_Agev_Numero_Rigo_Type</a>																								
facets	<table border="1"> <thead> <tr> <th>Kind</th> <th>Value</th> </tr> </thead> <tbody> <tr> <td>pattern</td> <td>[1-9]{1}[0-9]*</td> </tr> <tr> <td>enumeration</td> <td>1</td> </tr> <tr> <td>enumeration</td> <td>2</td> </tr> <tr> <td>enumeration</td> <td>3</td> </tr> <tr> <td>enumeration</td> <td>4</td> </tr> <tr> <td>enumeration</td> <td>5</td> </tr> <tr> <td>enumeration</td> <td>6</td> </tr> <tr> <td>enumeration</td> <td>7</td> </tr> <tr> <td>enumeration</td> <td>8</td> </tr> <tr> <td>enumeration</td> <td>9</td> </tr> <tr> <td>enumeration</td> <td>10</td> </tr> </tbody> </table>	Kind	Value	pattern	[1-9]{1}[0-9]*	enumeration	1	enumeration	2	enumeration	3	enumeration	4	enumeration	5	enumeration	6	enumeration	7	enumeration	8	enumeration	9	enumeration	10
Kind	Value																								
pattern	[1-9]{1}[0-9]*																								
enumeration	1																								
enumeration	2																								
enumeration	3																								
enumeration	4																								
enumeration	5																								
enumeration	6																								
enumeration	7																								
enumeration	8																								
enumeration	9																								
enumeration	10																								

element **Fabbricato\_Agev\_Type/NumModuloRiferimento**

diagram					
namespace	urn:www.agenziaentrate.gov.it:specificheTecniche:sco:730				
type	<a href="#">DatoNP_Type</a>				
facets	<table border="1"> <thead> <tr> <th>Kind</th> <th>Value</th> </tr> </thead> <tbody> <tr> <td>pattern</td> <td>[1-9]{1}[0-9]*</td> </tr> </tbody> </table>	Kind	Value	pattern	[1-9]{1}[0-9]*
Kind	Value				
pattern	[1-9]{1}[0-9]*				

element **Fabbricato\_Agev\_Type/DatiContratto**

diagram	
namespace	urn:www.agenziaentrate.gov.it:specificheTecniche:sco:730
type	<a href="#">m730:Dati_Contratto_Type</a>
children	<a href="#">m730:DataRegContratto</a> <a href="#">m730:SerieContratto</a> <a href="#">m730:NumeroContratto</a> <a href="#">m730:Sottonumero</a> <a href="#">m730:CodiceUfficio</a> <a href="#">m730:IdentificativoContratto</a>

element **Fabbricato\_Agev\_Type/CasellaInf30Giorni**

diagram	
namespace	urn:www.agenziaentrate.gov.it:specificheTecniche:sco:730
type	<a href="#">DatoCB_Type</a>
facets	Kind Value pattern [01]

element **Fabbricato\_Agev\_Type/AnnoDichiarazioneIcilmu**

diagram	
namespace	urn:www.agenziaentrate.gov.it:specificheTecniche:sco:730
type	<a href="#">DatoDA_Type</a>
facets	Kind Value pattern (18 19 20)[0-9]{2}

complexType **Fabbricato\_Ord\_Type**

diagram	
namespace	urn:www.agenziaentrate.gov.it:specificheTecniche:sco:730

children	<a href="#">m730:Rendita</a> <a href="#">m730:Utilizzo</a> <a href="#">m730:GiorniPossesso</a> <a href="#">m730:PercPossesso</a> <a href="#">m730:CodiceCanone</a> <a href="#">m730:CanoneLocazione</a> <a href="#">m730:CasiParticolari</a> <a href="#">m730:CasellaContinuazione</a> <a href="#">m730:CodiceComune</a> <a href="#">m730:OpzioneCedolare</a> <a href="#">m730:CasellaCasiPartlmu</a> <a href="#">m730:StatoEmergenza</a>
----------	---

#### element **Fabbricato\_Ord\_Type/Rendita**

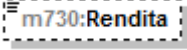
diagram					
namespace	urn:www.agenziaentrate.gov.it:specificheTecniche:sco:730				
type	<a href="#">DatoNP_Type</a>				
facets	<table border="1"> <thead> <tr> <th>Kind</th> <th>Value</th> </tr> </thead> <tbody> <tr> <td>pattern</td> <td>[1-9]{1}[0-9]*</td> </tr> </tbody> </table>	Kind	Value	pattern	[1-9]{1}[0-9]*
Kind	Value				
pattern	[1-9]{1}[0-9]*				

#### element **Fabbricato\_Ord\_Type/Utilizzo**

diagram																																	
namespace	urn:www.agenziaentrate.gov.it:specificheTecniche:sco:730																																
type	restriction of <a href="#">m730:Utilizzo_Fabbricato_Type</a>																																
facets	<table border="1"> <thead> <tr> <th>Kind</th> <th>Value</th> </tr> </thead> <tbody> <tr> <td>pattern</td> <td>[1-9]{1}[0-9]*</td> </tr> <tr> <td>enumeration</td> <td>1</td> </tr> <tr> <td>enumeration</td> <td>2</td> </tr> <tr> <td>enumeration</td> <td>3</td> </tr> <tr> <td>enumeration</td> <td>4</td> </tr> <tr> <td>enumeration</td> <td>5</td> </tr> <tr> <td>enumeration</td> <td>8</td> </tr> <tr> <td>enumeration</td> <td>9</td> </tr> <tr> <td>enumeration</td> <td>10</td> </tr> <tr> <td>enumeration</td> <td>11</td> </tr> <tr> <td>enumeration</td> <td>12</td> </tr> <tr> <td>enumeration</td> <td>14</td> </tr> <tr> <td>enumeration</td> <td>15</td> </tr> <tr> <td>enumeration</td> <td>16</td> </tr> <tr> <td>enumeration</td> <td>17</td> </tr> </tbody> </table>	Kind	Value	pattern	[1-9]{1}[0-9]*	enumeration	1	enumeration	2	enumeration	3	enumeration	4	enumeration	5	enumeration	8	enumeration	9	enumeration	10	enumeration	11	enumeration	12	enumeration	14	enumeration	15	enumeration	16	enumeration	17
Kind	Value																																
pattern	[1-9]{1}[0-9]*																																
enumeration	1																																
enumeration	2																																
enumeration	3																																
enumeration	4																																
enumeration	5																																
enumeration	8																																
enumeration	9																																
enumeration	10																																
enumeration	11																																
enumeration	12																																
enumeration	14																																
enumeration	15																																
enumeration	16																																
enumeration	17																																

#### element **Fabbricato\_Ord\_Type/GiorniPossesso**

diagram					
namespace	urn:www.agenziaentrate.gov.it:specificheTecniche:sco:730				
type	restriction of <a href="#">DatoNP_Type</a>				
facets	<table border="1"> <thead> <tr> <th>Kind</th> <th>Value</th> </tr> </thead> <tbody> <tr> <td>pattern</td> <td>[1-9]{1}[0-9]*</td> </tr> </tbody> </table>	Kind	Value	pattern	[1-9]{1}[0-9]*
Kind	Value				
pattern	[1-9]{1}[0-9]*				

#### element **Fabbricato\_Ord\_Type/PercPossesso**

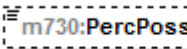
diagram	
---------	---

namespace	urn:www.agenziaentrate.gov.it:specificheTecniche:sco:730				
type	<a href="#">DatoPC_Type</a>				
facets	<table border="1"> <thead> <tr> <th>Kind</th> <th>Value</th> </tr> </thead> <tbody> <tr> <td>pattern</td> <td>[0-9]?[0-9](,\d{1,3})? 100,0{1,3}?</td> </tr> </tbody> </table>	Kind	Value	pattern	[0-9]?[0-9](,\d{1,3})? 100,0{1,3}?
Kind	Value				
pattern	[0-9]?[0-9](,\d{1,3})? 100,0{1,3}?				

#### element **Fabbricato\_Ord\_Type/CodiceCanone**

diagram													
namespace	urn:www.agenziaentrate.gov.it:specificheTecniche:sco:730												
type	<a href="#">m730:Codice Canone Type</a>												
facets	<table border="1"> <thead> <tr> <th>Kind</th> <th>Value</th> </tr> </thead> <tbody> <tr> <td>pattern</td> <td>[1-9]</td> </tr> <tr> <td>enumeration</td> <td>1</td> </tr> <tr> <td>enumeration</td> <td>2</td> </tr> <tr> <td>enumeration</td> <td>3</td> </tr> <tr> <td>enumeration</td> <td>4</td> </tr> </tbody> </table>	Kind	Value	pattern	[1-9]	enumeration	1	enumeration	2	enumeration	3	enumeration	4
Kind	Value												
pattern	[1-9]												
enumeration	1												
enumeration	2												
enumeration	3												
enumeration	4												

#### element **Fabbricato\_Ord\_Type/CanoneLocazione**

diagram					
namespace	urn:www.agenziaentrate.gov.it:specificheTecniche:sco:730				
type	<a href="#">DatoNP_Type</a>				
facets	<table border="1"> <thead> <tr> <th>Kind</th> <th>Value</th> </tr> </thead> <tbody> <tr> <td>pattern</td> <td>[1-9]{1}[0-9]*</td> </tr> </tbody> </table>	Kind	Value	pattern	[1-9]{1}[0-9]*
Kind	Value				
pattern	[1-9]{1}[0-9]*				

#### element **Fabbricato\_Ord\_Type/CasiParticolari**

diagram													
namespace	urn:www.agenziaentrate.gov.it:specificheTecniche:sco:730												
type	<a href="#">m730:Casi Particolari Fabbricato Type</a>												
facets	<table border="1"> <thead> <tr> <th>Kind</th> <th>Value</th> </tr> </thead> <tbody> <tr> <td>pattern</td> <td>[1-9]</td> </tr> <tr> <td>enumeration</td> <td>1</td> </tr> <tr> <td>enumeration</td> <td>3</td> </tr> <tr> <td>enumeration</td> <td>4</td> </tr> <tr> <td>enumeration</td> <td>5</td> </tr> </tbody> </table>	Kind	Value	pattern	[1-9]	enumeration	1	enumeration	3	enumeration	4	enumeration	5
Kind	Value												
pattern	[1-9]												
enumeration	1												
enumeration	3												
enumeration	4												
enumeration	5												

#### element **Fabbricato\_Ord\_Type/CasellaContinuazione**

diagram	
namespace	urn:www.agenziaentrate.gov.it:specificheTecniche:sco:730
type	<a href="#">DatoCB_Type</a>

facets	Kind	Value
	pattern	[01]

#### element **Fabbricato\_Ord\_Type/CodiceComune**

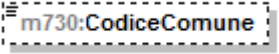
diagram					
namespace	urn:www.agenziaentrate.gov.it:specificheTecniche:sco:730				
type	restriction of <a href="#">DatoAN_Type</a>				
facets	<table border="1"> <tr> <td>Kind</td> <td>Value</td> </tr> <tr> <td>pattern</td> <td>(([0-9A-Z\-\] \&amp;quot;){1}){1}([ 0-9A-Z&amp;amp;:] \- \., / \^\(\ \)\ À É Ì Ò Ù Ü &amp;quot; \ \\ \ +)*</td> </tr> </table>	Kind	Value	pattern	(([0-9A-Z\-\] \&quot;){1}){1}([ 0-9A-Z&amp;:] \- \., / \^\(\ \)\ À É Ì Ò Ù Ü &quot; \ \\ \ +)*
Kind	Value				
pattern	(([0-9A-Z\-\] \&quot;){1}){1}([ 0-9A-Z&amp;:] \- \., / \^\(\ \)\ À É Ì Ò Ù Ü &quot; \ \\ \ +)*				

#### element **Fabbricato\_Ord\_Type/OpzioneCedolare**

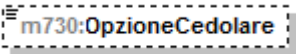
diagram					
namespace	urn:www.agenziaentrate.gov.it:specificheTecniche:sco:730				
type	<a href="#">DatoCB_Type</a>				
facets	<table border="1"> <tr> <td>Kind</td> <td>Value</td> </tr> <tr> <td>pattern</td> <td>[01]</td> </tr> </table>	Kind	Value	pattern	[01]
Kind	Value				
pattern	[01]				

#### element **Fabbricato\_Ord\_Type/CasellaCasiPartImu**

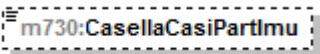
diagram											
namespace	urn:www.agenziaentrate.gov.it:specificheTecniche:sco:730										
type	restriction of <a href="#">DatoN1_Type</a>										
facets	<table border="1"> <tr> <td>Kind</td> <td>Value</td> </tr> <tr> <td>pattern</td> <td>[1-9]</td> </tr> <tr> <td>enumeration</td> <td>1</td> </tr> <tr> <td>enumeration</td> <td>2</td> </tr> <tr> <td>enumeration</td> <td>3</td> </tr> </table>	Kind	Value	pattern	[1-9]	enumeration	1	enumeration	2	enumeration	3
Kind	Value										
pattern	[1-9]										
enumeration	1										
enumeration	2										
enumeration	3										

#### element **Fabbricato\_Ord\_Type/StatoEmergenza**

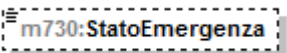
diagram					
namespace	urn:www.agenziaentrate.gov.it:specificheTecniche:sco:730				
type	<a href="#">DatoCB_Type</a>				
facets	<table border="1"> <tr> <td>Kind</td> <td>Value</td> </tr> <tr> <td>pattern</td> <td>[01]</td> </tr> </table>	Kind	Value	pattern	[01]
Kind	Value				
pattern	[01]				



complexType **Familiari\_Type**

diagram	
namespace	urn:www.agenziaentrate.gov.it:specificheTecniche:sco:730
children	<a href="#">m730:PrimoModulo</a> <a href="#">m730:Modulo</a>

element **Familiari\_Type/PrimoModulo**

diagram	
namespace	urn:www.agenziaentrate.gov.it:specificheTecniche:sco:730
type	<a href="#">m730:Primo_Modulo_Familiari_Type</a>
children	<a href="#">m730:Coniuge</a> <a href="#">m730:PrimoFiglio</a> <a href="#">m730:Familiari</a> <a href="#">m730:PercUlteriore</a> <a href="#">m730:FigliAffidoPread</a>

element **Familiari\_Type/Modulo**

diagram	
namespace	urn:www.agenziaentrate.gov.it:specificheTecniche:sco:730
type	<a href="#">m730:Modulo_Familiari_Type</a>
children	<a href="#">m730:Coniuge</a> <a href="#">m730:PrimoFiglio</a> <a href="#">m730:Familiari</a>

complexType Firma\_Dichiarazione\_Type

diagram	
namespace	urn:www.agenziaentrate.gov.it:specificheTecniche:sco:730
children	<a href="#">m730:NumeroModelli</a> <a href="#">m730:FirmaDichiarazione</a> <a href="#">m730:OpzioneInformativa</a> <a href="#">m730:SoggettoFiscalmenteCarico</a> <a href="#">m730:QuadroK</a>

element Firma\_Dichiarazione\_Type/NumeroModelli

diagram					
namespace	urn:www.agenziaentrate.gov.it:specificheTecniche:sco:730				
type	<a href="#">DatoNP_Type</a>				
facets	<table border="1"> <tr> <td>Kind</td> <td>Value</td> </tr> <tr> <td>pattern</td> <td>[1-9]{1}[0-9]*</td> </tr> </table>	Kind	Value	pattern	[1-9]{1}[0-9]*
Kind	Value				
pattern	[1-9]{1}[0-9]*				

element Firma\_Dichiarazione\_Type/FirmaDichiarazione

diagram					
namespace	urn:www.agenziaentrate.gov.it:specificheTecniche:sco:730				
type	<a href="#">DatoCB_Type</a>				
facets	<table border="1"> <tr> <td>Kind</td> <td>Value</td> </tr> <tr> <td>pattern</td> <td>[01]</td> </tr> </table>	Kind	Value	pattern	[01]
Kind	Value				
pattern	[01]				

element Firma\_Dichiarazione\_Type/OpzioneInformativa

diagram					
namespace	urn:www.agenziaentrate.gov.it:specificheTecniche:sco:730				
type	<a href="#">DatoCB_Type</a>				
facets	<table border="1"> <tr> <td>Kind</td> <td>Value</td> </tr> <tr> <td>pattern</td> <td>[01]</td> </tr> </table>	Kind	Value	pattern	[01]
Kind	Value				
pattern	[01]				

element **Firma\_Dichiarazione\_Type/SoggettoFiscalmenteCarico**

diagram	
namespace	urn:www.agenziaentrate.gov.it:specificheTecniche:sco:730
type	<a href="#">DatoCB_Type</a>
facets	Kind Value pattern [01]

element **Firma\_Dichiarazione\_Type/QuadroK**

diagram	
namespace	urn:www.agenziaentrate.gov.it:specificheTecniche:sco:730
type	<a href="#">DatoCB_Type</a>
facets	Kind Value pattern [01]

complexType **Fondo\_Pensione\_Dipendenti\_Pubblici\_Type**

diagram	
namespace	urn:www.agenziaentrate.gov.it:specificheTecniche:sco:730
children	<a href="#">m730:Contributi</a> <a href="#">m730:QuotaTFR</a>

element **Fondo\_Pensione\_Dipendenti\_Pubblici\_Type/Contributi**

diagram	
namespace	urn:www.agenziaentrate.gov.it:specificheTecniche:sco:730
type	<a href="#">m730:Contributi</a> <a href="#">Previdenza Complementare Type</a>
children	<a href="#">m730:EsclusiDalSostituto</a> <a href="#">m730:NonEsclusiDalSostituto</a>

element **Fondo\_Pensione\_Dipendenti\_Pubblici\_Type/QuotaTFR**

diagram	
---------	--

namespace	urn:www.agenziaentrate.gov.it:specificheTecniche:sco:730
type	<a href="#">DatoNP_Type</a>
facets	Kind Value pattern [1-9]{1}[0-9]*

### complexType Frontespizio\_730\_Type

diagram	
namespace	urn:www.agenziaentrate.gov.it:specificheTecniche:sco:730
children	<a href="#">m730:SoggettoFiscale</a> <a href="#">m730:DatiAnagrafici</a> <a href="#">m730:StatoCivile</a> <a href="#">m730:ResidenzaAnagrafica</a> <a href="#">m730:DomicilioFiscaleSaldo</a> <a href="#">m730:DomicilioFiscaleAcconto</a> <a href="#">m730:CasiParticolariAddizionale</a> <a href="#">m730:Firma</a>

### element Frontespizio\_730\_Type/SoggettoFiscale

diagram	
namespace	urn:www.agenziaentrate.gov.it:specificheTecniche:sco:730
type	<a href="#">m730:Soggetto_Fiscale_730_Type</a>
children	<a href="#">m730:CodiceFiscale</a> <a href="#">m730:Email</a> <a href="#">m730:Telefono</a> <a href="#">m730:Cellulare</a>

element **Frontespizio\_730\_Type/DatiAnagrafici**

diagram	
namespace	urn:www.agenziaentrate.gov.it:specificheTecniche:sco:730
type	<a href="#">Dati_Anagrafici_Type</a>
children	<a href="#">Cognome</a> <a href="#">Nome</a> <a href="#">Sesso</a> <a href="#">DataNascita</a> <a href="#">ComuneNascita</a> <a href="#">ProvinciaNascita</a>

element **Frontespizio\_730\_Type/StatoCivile**

diagram									
namespace	urn:www.agenziaentrate.gov.it:specificheTecniche:sco:730								
type	<a href="#">m730:Stato_Civile_Type</a>								
facets	<table border="1"> <thead> <tr> <th>Kind</th> <th>Value</th> </tr> </thead> <tbody> <tr> <td>pattern</td> <td>[1-9]{1}[0-9]*</td> </tr> <tr> <td>enumeration</td> <td>7</td> </tr> <tr> <td>enumeration</td> <td>8</td> </tr> </tbody> </table>	Kind	Value	pattern	[1-9]{1}[0-9]*	enumeration	7	enumeration	8
Kind	Value								
pattern	[1-9]{1}[0-9]*								
enumeration	7								
enumeration	8								

element Frontespizio\_730\_Type/ResidenzaAnagrafica

<p>diagram</p>	
<p>namespace</p>	<p>urn:www.agenziaentrate.gov.it:specificheTecniche:sco:730</p>
<p>type</p>	<p><a href="#">m730:Residenza_Anagrafica_730_Type</a></p>
<p>children</p>	<p><a href="#">Comune</a> <a href="#">Provincia</a> <a href="#">CodiceComune</a> <a href="#">Indirizzo</a> <a href="#">Cap</a> <a href="#">DataVariazione</a> <a href="#">m730:Tipologia</a> <a href="#">m730:NumCivico</a> <a href="#">m730:Frazione</a> <a href="#">m730:PrimaPresentazione</a></p>

element Frontespizio\_730\_Type/DomicilioFiscaleSaldo

<p>diagram</p>	
<p>namespace</p>	<p>urn:www.agenziaentrate.gov.it:specificheTecniche:sco:730</p>
<p>type</p>	<p><a href="#">m730:Domicilio_Fiscale_Type</a></p>
<p>children</p>	<p><a href="#">m730:Comune</a> <a href="#">m730:Provincia</a> <a href="#">m730:CodiceComune</a> <a href="#">m730:FusioneComuni</a></p>

element **Frontespizio\_730\_Type/DomicilioFiscaleAcconto**

diagram	
namespace	urn:www.agenziaentrate.gov.it:specificheTecniche:sco:730
type	<a href="#">m730:Domicilio_Fiscale_Type</a>
children	<a href="#">m730:Comune</a> <a href="#">m730:Provincia</a> <a href="#">m730:CodiceComune</a> <a href="#">m730:FusioneComuni</a>

element **Frontespizio\_730\_Type/CasiParticolariAddizionale**

diagram									
namespace	urn:www.agenziaentrate.gov.it:specificheTecniche:sco:730								
type	restriction of <a href="#">DatoN1_Type</a>								
facets	<table border="1"> <thead> <tr> <th>Kind</th> <th>Value</th> </tr> </thead> <tbody> <tr> <td>pattern</td> <td>[1-9]</td> </tr> <tr> <td>enumeration</td> <td>1</td> </tr> <tr> <td>enumeration</td> <td>2</td> </tr> </tbody> </table>	Kind	Value	pattern	[1-9]	enumeration	1	enumeration	2
Kind	Value								
pattern	[1-9]								
enumeration	1								
enumeration	2								

element **Frontespizio\_730\_Type/Firma**

diagram	
namespace	urn:www.agenziaentrate.gov.it:specificheTecniche:sco:730
type	<a href="#">m730:Firma_Dichiarazione_Type</a>
children	<a href="#">m730:NumeroModelli</a> <a href="#">m730:FirmaDichiarazione</a> <a href="#">m730:OpzioneInformativa</a> <a href="#">m730:SoggettoFiscalmenteCarico</a> <a href="#">m730:QuadroK</a>

complexType **Frontespizio\_Con\_Type**

<p>diagram</p>	<p>The diagram illustrates the structure of the <code>Frontespizio_Con_Type</code> complex type. It is an extension of the <code>m730:Frontespizio_730_Type</code>. The <code>Frontespizio_Con_Type</code> is represented by a rounded rectangle with a small square on its right side. A dashed line with a small square on its left side connects it to a larger rounded rectangle representing the extension. This extension contains several child elements, each in a rounded rectangle with a small square on its right side: <code>m730:SoggettoFiscale</code>, <code>m730:DatiAnagrafici</code>, <code>m730:StatoCivile</code>, <code>m730:ResidenzaAnagrafica</code>, <code>m730:DomicilioFiscaleSaldo</code>, <code>m730:DomicilioFiscaleAcconto</code>, <code>m730:CasiParticolariAddizionale</code>, and <code>m730:Firma</code>. The elements <code>m730:StatoCivile</code>, <code>m730:ResidenzaAnagrafica</code>, <code>m730:DomicilioFiscaleAcconto</code>, and <code>m730:CasiParticolariAddizionale</code> are shown with dashed borders, indicating they are inherited from the base type. The other elements have solid borders, indicating they are new to the extension. All elements have a small square with a plus sign on their right side, indicating they are optional.</p>
<p>namespace</p>	<p>urn:www.agenziaentrate.gov.it:specificheTecniche:sco:730</p>
<p>type</p>	<p>extension of <a href="#">m730:Frontespizio_730_Type</a></p>
<p>children</p>	<p><a href="#">m730:SoggettoFiscale</a> <a href="#">m730:DatiAnagrafici</a> <a href="#">m730:StatoCivile</a> <a href="#">m730:ResidenzaAnagrafica</a>  <a href="#">m730:DomicilioFiscaleSaldo</a> <a href="#">m730:DomicilioFiscaleAcconto</a> <a href="#">m730:CasiParticolariAddizionale</a> <a href="#">m730:Firma</a></p>



complexType **Frontespizio\_Dich\_Type**

diagram	
namespace	urn:www.agenziaentrate.gov.it:specificheTecniche:sco:730
type	extension of <a href="#">m730:Frontespizio_730_Type</a>
children	<a href="#">m730:SoggettoFiscale</a> <a href="#">m730:DatiAnagrafici</a> <a href="#">m730:StatoCivile</a> <a href="#">m730:ResidenzaAnagrafica</a> <a href="#">m730:DomicilioFiscaleSaldo</a> <a href="#">m730:DomicilioFiscaleAcconto</a> <a href="#">m730:CasiParticolariAddizionale</a> <a href="#">m730:Firma</a> <a href="#">m730:Rappresentante</a>

element **Frontespizio\_Dich\_Type/Rappresentante**

diagram	
namespace	urn:www.agenziaentrate.gov.it:specificheTecniche:sco:730
type	<a href="#">m730:Rappresentante_Type</a>
children	<a href="#">m730:SoggettoFiscale</a> <a href="#">m730:DatiAnagrafici</a> <a href="#">m730:ResidenzaAnagrafica</a> <a href="#">m730:Firma</a>

complexType **Fuori\_Assistenza\_Type**

diagram	
namespace	urn:www.agenziaentrate.gov.it:specificheTecniche:sco:730
children	<a href="#">m730:AnomaliaDatianagrafici</a> <a href="#">m730:AnomaliaTerreni</a> <a href="#">m730:AnomaliaFabbricati</a> <a href="#">m730:AnomaliaLavDip</a> <a href="#">m730:AnomaliaAltriRedditi</a> <a href="#">m730:AnomaliaQuadroF</a>

element **Fuori\_Assistenza\_Type/AnomaliaDatianagrafici**

diagram					
namespace	urn:www.agenziaentrate.gov.it:specificheTecniche:sco:730				
type	<a href="#">DatoCB_Type</a>				
facets	<table border="1"> <tr> <td>Kind</td> <td>Value</td> </tr> <tr> <td>pattern</td> <td>[01]</td> </tr> </table>	Kind	Value	pattern	[01]
Kind	Value				
pattern	[01]				

element **Fuori\_Assistenza\_Type/AnomaliaTerreni**

diagram					
namespace	urn:www.agenziaentrate.gov.it:specificheTecniche:sco:730				
type	<a href="#">DatoCB_Type</a>				
facets	<table border="1"> <tr> <td>Kind</td> <td>Value</td> </tr> <tr> <td>pattern</td> <td>[01]</td> </tr> </table>	Kind	Value	pattern	[01]
Kind	Value				
pattern	[01]				

element **Fuori\_Assistenza\_Type/AnomaliaFabbricati**

diagram					
namespace	urn:www.agenziaentrate.gov.it:specificheTecniche:sco:730				
type	<a href="#">DatoCB_Type</a>				
facets	<table border="1"> <tr> <td>Kind</td> <td>Value</td> </tr> <tr> <td>pattern</td> <td>[01]</td> </tr> </table>	Kind	Value	pattern	[01]
Kind	Value				
pattern	[01]				

**element Fuori\_Assistenza\_Type/AnomaliaLavDip**

diagram	
namespace	urn:www.agenziaentrate.gov.it:specificheTecniche:sco:730
type	<a href="#">DatoCB_Type</a>
facets	Kind Value pattern [01]

**element Fuori\_Assistenza\_Type/AnomaliaAltriRedditi**

diagram	
namespace	urn:www.agenziaentrate.gov.it:specificheTecniche:sco:730
type	<a href="#">DatoCB_Type</a>
facets	Kind Value pattern [01]

**element Fuori\_Assistenza\_Type/AnomaliaQuadroF**

diagram	
namespace	urn:www.agenziaentrate.gov.it:specificheTecniche:sco:730
type	<a href="#">DatoCB_Type</a>
facets	Kind Value pattern [01]

**complexType Giorni\_Percentuale\_Type**

diagram	
namespace	urn:www.agenziaentrate.gov.it:specificheTecniche:sco:730
children	<a href="#">m730:Giorni</a> <a href="#">m730:Percentuale</a>

**element Giorni\_Percentuale\_Type/Giorni**

diagram	
namespace	urn:www.agenziaentrate.gov.it:specificheTecniche:sco:730
type	<a href="#">DatoNP_Type</a>
facets	Kind Value pattern [1-9]{1}[0-9]*

element **Giorni\_Percentuale\_Type/Percentuale**

diagram	
namespace	urn:www.agenziaentrate.gov.it:specificheTecniche:sco:730
type	<a href="#">DatoPC_Type</a>
facets	Kind Value pattern [0-9]?[0-9](,\.d(1,3))?. 100(,0(1,3))?

complexType **Importi\_Rimborsare\_730-4\_Integrativo\_Type**

diagram	
namespace	urn:www.agenziaentrate.gov.it:specificheTecniche:sco:730
type	extension of <a href="#">m730:Importi_Rimborsare_730-4_Type</a>
children	<a href="#">m730:IrpefRimborsare</a> <a href="#">m730:AddRegRimborsare</a> <a href="#">m730:AddComRimborsare</a> <a href="#">m730:CedolareRimborsare</a> <a href="#">m730:TassazioneSepRimborsare</a> <a href="#">m730:PremiRisultatoRimborsare</a>

element **Importi\_Rimborsare\_730-4\_Integrativo\_Type/TassazioneSepRimborsare**

diagram	
namespace	urn:www.agenziaentrate.gov.it:specificheTecniche:sco:730
type	<a href="#">m730:Importo_730-4</a>
children	<a href="#">m730:ImportoDichiarante</a> <a href="#">m730:ImportoConiuge</a> <a href="#">m730:ImportoTotale</a>

element **Importi\_Rimborsare\_730-4\_Integrativo\_Type/PremiRisultatoRimborsare**

diagram	
namespace	urn:www.agenziaentrate.gov.it:specificheTecniche:sco:730
type	<a href="#">m730:Importo_730-4</a>
children	<a href="#">m730:ImportoDichiarante</a> <a href="#">m730:ImportoConiuge</a> <a href="#">m730:ImportoTotale</a>

complexType **Importi\_Rimborsare\_730-4\_Type**

diagram	
namespace	urn:www.agenziaentrate.gov.it:specificheTecniche:sco:730
children	<a href="#">m730:IrpefRimborsare</a> <a href="#">m730:AddRegRimborsare</a> <a href="#">m730:AddComRimborsare</a> <a href="#">m730:CedolareRimborsare</a>

element **Importi\_Rimborsare\_730-4\_Type/IrpefRimborsare**

diagram	
namespace	urn:www.agenziaentrate.gov.it:specificheTecniche:sco:730
type	<a href="#">m730:Importo_730-4</a>
children	<a href="#">m730:ImportoDichiarante</a> <a href="#">m730:ImportoConiuge</a> <a href="#">m730:ImportoTotale</a>

element **Importi\_Rimborsare\_730-4\_Type/AddRegRimborsare**

diagram	
namespace	urn:www.agenziaentrate.gov.it:specificheTecniche:sco:730
children	<a href="#">m730:ImportoAddizionale</a> <a href="#">m730:CodiceRegioneDichiarante</a> <a href="#">m730:CodiceRegioneConiuge</a>

element **Importi\_Rimborsare\_730-4\_Type/AddRegRimborsare/ImportoAddizionale**

diagram	
namespace	urn:www.agenziaentrate.gov.it:specificheTecniche:sco:730
type	<a href="#">m730:Importo_730-4</a>
children	<a href="#">m730:ImportoDichiarante</a> <a href="#">m730:ImportoConiuge</a> <a href="#">m730:ImportoTotale</a>

element **Importi\_Rimborsare\_730-4\_Type/AddRegRimborsare/CodiceRegioneDichiarante**

diagram																																									
namespace	urn:www.agenziaentrate.gov.it:specificheTecniche:sco:730																																								
type	<a href="#">Codice Regione Type</a>																																								
facets	<table border="1"> <thead> <tr> <th>Kind</th> <th>Value</th> </tr> </thead> <tbody> <tr> <td>pattern</td> <td>([0-9A-Z\-\_] &amp;quot;){1}([ 0-9A-Z&amp;amp;:] ' \- \-\. / ° \^\(\\) À È É Ì Ò Ù Ü &amp;quot; \N \\+)*</td> </tr> <tr><td>enumeration</td><td>1</td></tr> <tr><td>enumeration</td><td>2</td></tr> <tr><td>enumeration</td><td>3</td></tr> <tr><td>enumeration</td><td>4</td></tr> <tr><td>enumeration</td><td>5</td></tr> <tr><td>enumeration</td><td>6</td></tr> <tr><td>enumeration</td><td>7</td></tr> <tr><td>enumeration</td><td>8</td></tr> <tr><td>enumeration</td><td>9</td></tr> <tr><td>enumeration</td><td>10</td></tr> <tr><td>enumeration</td><td>11</td></tr> <tr><td>enumeration</td><td>12</td></tr> <tr><td>enumeration</td><td>13</td></tr> <tr><td>enumeration</td><td>14</td></tr> <tr><td>enumeration</td><td>15</td></tr> <tr><td>enumeration</td><td>16</td></tr> <tr><td>enumeration</td><td>17</td></tr> <tr><td>enumeration</td><td>18</td></tr> </tbody> </table>	Kind	Value	pattern	([0-9A-Z\-\_] &quot;){1}([ 0-9A-Z&amp;:] ' \- \-\. / ° \^\(\\) À È É Ì Ò Ù Ü &quot; \N \\+)*	enumeration	1	enumeration	2	enumeration	3	enumeration	4	enumeration	5	enumeration	6	enumeration	7	enumeration	8	enumeration	9	enumeration	10	enumeration	11	enumeration	12	enumeration	13	enumeration	14	enumeration	15	enumeration	16	enumeration	17	enumeration	18
Kind	Value																																								
pattern	([0-9A-Z\-\_] &quot;){1}([ 0-9A-Z&amp;:] ' \- \-\. / ° \^\(\\) À È É Ì Ò Ù Ü &quot; \N \\+)*																																								
enumeration	1																																								
enumeration	2																																								
enumeration	3																																								
enumeration	4																																								
enumeration	5																																								
enumeration	6																																								
enumeration	7																																								
enumeration	8																																								
enumeration	9																																								
enumeration	10																																								
enumeration	11																																								
enumeration	12																																								
enumeration	13																																								
enumeration	14																																								
enumeration	15																																								
enumeration	16																																								
enumeration	17																																								
enumeration	18																																								

	enumeration	19
	enumeration	20
	enumeration	21

element **Importi\_Rimborsare\_730-4\_Type/AddRegRimborsare/CodiceRegioneConiuge**

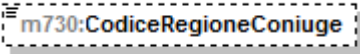
diagram		
namespace	urn:www.agenziaentrate.gov.it:specificheTecniche:sco:730	
type	<a href="#">Codice Regione Type</a>	
facets	Kind	Value
	pattern	(([0-9A-Z\-\-]]&quot;){1}([ 0-9A-Z&amp;]] '\- \- . \- \^\^\(\ \)\ À É È Ì Ò Ù Û &quot; \^\^\ \+)*
	enumeration	1
	enumeration	2
	enumeration	3
	enumeration	4
	enumeration	5
	enumeration	6
	enumeration	7
	enumeration	8
	enumeration	9
	enumeration	10
	enumeration	11
	enumeration	12
	enumeration	13
	enumeration	14
	enumeration	15
	enumeration	16
	enumeration	17
	enumeration	18
	enumeration	19
	enumeration	20
	enumeration	21

element **Importi\_Rimborsare\_730-4\_Type/AddComRimborsare**

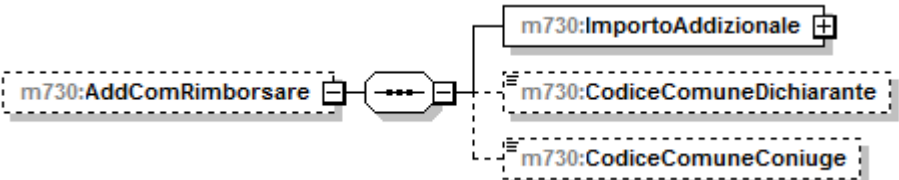
diagram		
namespace	urn:www.agenziaentrate.gov.it:specificheTecniche:sco:730	
children	<a href="#">m730:ImportoAddizionale</a> <a href="#">m730:CodiceComuneDichiarante</a> <a href="#">m730:CodiceComuneConiuge</a>	

element **Importi\_Rimborsare\_730-4\_Type/AddComRimborsare/ImportoAddizionale**

diagram	
namespace	urn:www.agenziaentrate.gov.it:specificheTecniche:sco:730
type	<a href="#">m730:Importo_730-4</a>
children	<a href="#">m730:ImportoDichiarante</a> <a href="#">m730:ImportoConiuge</a> <a href="#">m730:ImportoTotale</a>

element **Importi\_Rimborsare\_730-4\_Type/AddComRimborsare/CodiceComuneDichiarante**

diagram					
namespace	urn:www.agenziaentrate.gov.it:specificheTecniche:sco:730				
type	<a href="#">DatoAN_Type</a>				
facets	<table border="1"> <thead> <tr> <th>Kind</th> <th>Value</th> </tr> </thead> <tbody> <tr> <td>pattern</td> <td>(([0-9A-Z-] &amp;quot;){1}([ 0-9A-Z&amp;amp;] ' - \., / ^ \(\) \) À É È Ì Ò Ù Û &amp;quot; \ \\ \ +)*</td> </tr> </tbody> </table>	Kind	Value	pattern	(([0-9A-Z-] &quot;){1}([ 0-9A-Z&amp;] ' - \., / ^ \(\) \) À É È Ì Ò Ù Û &quot; \ \\ \ +)*
Kind	Value				
pattern	(([0-9A-Z-] &quot;){1}([ 0-9A-Z&amp;] ' - \., / ^ \(\) \) À É È Ì Ò Ù Û &quot; \ \\ \ +)*				

element **Importi\_Rimborsare\_730-4\_Type/AddComRimborsare/CodiceComuneConiuge**

diagram					
namespace	urn:www.agenziaentrate.gov.it:specificheTecniche:sco:730				
type	<a href="#">DatoAN_Type</a>				
facets	<table border="1"> <thead> <tr> <th>Kind</th> <th>Value</th> </tr> </thead> <tbody> <tr> <td>pattern</td> <td>(([0-9A-Z-] &amp;quot;){1}([ 0-9A-Z&amp;amp;] ' - \., / ^ \(\) \) À É È Ì Ò Ù Û &amp;quot; \ \\ \ +)*</td> </tr> </tbody> </table>	Kind	Value	pattern	(([0-9A-Z-] &quot;){1}([ 0-9A-Z&amp;] ' - \., / ^ \(\) \) À É È Ì Ò Ù Û &quot; \ \\ \ +)*
Kind	Value				
pattern	(([0-9A-Z-] &quot;){1}([ 0-9A-Z&amp;] ' - \., / ^ \(\) \) À É È Ì Ò Ù Û &quot; \ \\ \ +)*				

element **Importi\_Rimborsare\_730-4\_Type/CedolareRimborsare**

diagram	
namespace	urn:www.agenziaentrate.gov.it:specificheTecniche:sco:730
type	<a href="#">m730:Importo_730-4</a>



children	<a href="#">m730:ImportoDichiarante</a> <a href="#">m730:ImportoConiuge</a> <a href="#">m730:ImportoTotale</a>
----------	--

### complexType **Importi\_Trattenere\_730-4\_Type**

diagram	
namespace	urn:www.agenziaentrate.gov.it:specificheTecniche:sco:730
children	<a href="#">m730:IrpefTrattenere</a> <a href="#">m730:AddRegTrattenere</a> <a href="#">m730:AddComTrattenere</a> <a href="#">m730:IrpefPrimaRataTrattenere</a> <a href="#">m730:IrpefSecondaRataTrattenere</a> <a href="#">m730:TassSepAccontoTrattenere</a> <a href="#">m730:AddComAccontoTrattenere</a> <a href="#">m730:PremiRisultatoTrattenere</a> <a href="#">m730:CedolareTrattenere</a> <a href="#">m730:CedolarePrimaRataTrattenere</a> <a href="#">m730:CedolareSecondaRataTrattenere</a>

### element **Importi\_Trattenere\_730-4\_Type/IrpefTrattenere**

diagram	
namespace	urn:www.agenziaentrate.gov.it:specificheTecniche:sco:730
type	<a href="#">m730:Importo_730-4</a>
children	<a href="#">m730:ImportoDichiarante</a> <a href="#">m730:ImportoConiuge</a> <a href="#">m730:ImportoTotale</a>

element **Importi\_Trattenere\_730-4\_Type/AddRegTrattenere**

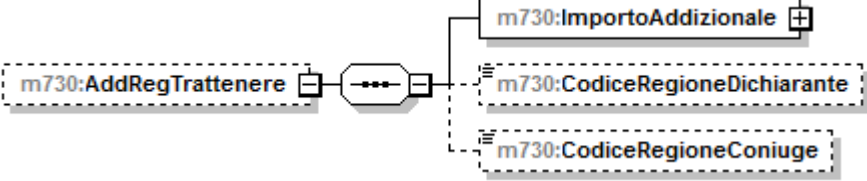
diagram	
namespace	urn:www.agenziaentrate.gov.it:specificheTecniche:sco:730
children	<a href="#">m730:ImportoAddizionale</a> <a href="#">m730:CodiceRegioneDichiarante</a> <a href="#">m730:CodiceRegioneConiuge</a>

element **Importi\_Trattenere\_730-4\_Type/AddRegTrattenere/ImportoAddizionale**

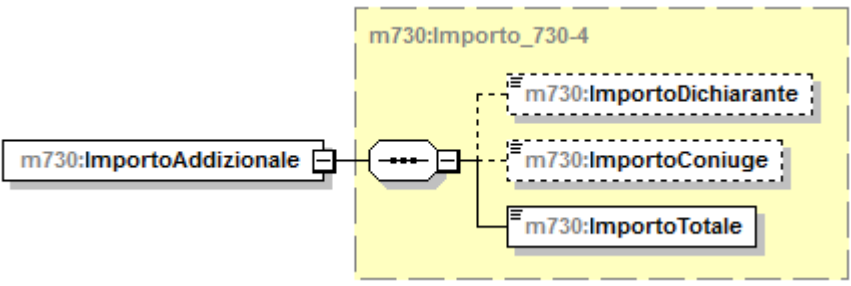
diagram	
namespace	urn:www.agenziaentrate.gov.it:specificheTecniche:sco:730
type	<a href="#">m730:Importo_730-4</a>
children	<a href="#">m730:ImportoDichiarante</a> <a href="#">m730:ImportoConiuge</a> <a href="#">m730:ImportoTotale</a>

element **Importi\_Trattenere\_730-4\_Type/AddRegTrattenere/CodiceRegioneDichiarante**

diagram																																					
namespace	urn:www.agenziaentrate.gov.it:specificheTecniche:sco:730																																				
type	<a href="#">Codice Regione Type</a>																																				
facets	<table border="1"> <thead> <tr> <th>Kind</th> <th>Value</th> </tr> </thead> <tbody> <tr> <td>pattern</td> <td>{([0-9A-Z\-\ ]&amp;quot;)}{1}([ 0-9A-Z&amp;amp;] '\- \., /°\^\(\\ )À È É ì ò ù Ü &amp;quot;;\ \\ /+)*</td> </tr> <tr><td>enumeration</td><td>1</td></tr> <tr><td>enumeration</td><td>2</td></tr> <tr><td>enumeration</td><td>3</td></tr> <tr><td>enumeration</td><td>4</td></tr> <tr><td>enumeration</td><td>5</td></tr> <tr><td>enumeration</td><td>6</td></tr> <tr><td>enumeration</td><td>7</td></tr> <tr><td>enumeration</td><td>8</td></tr> <tr><td>enumeration</td><td>9</td></tr> <tr><td>enumeration</td><td>10</td></tr> <tr><td>enumeration</td><td>11</td></tr> <tr><td>enumeration</td><td>12</td></tr> <tr><td>enumeration</td><td>13</td></tr> <tr><td>enumeration</td><td>14</td></tr> <tr><td>enumeration</td><td>15</td></tr> <tr><td>enumeration</td><td>16</td></tr> </tbody> </table>	Kind	Value	pattern	{([0-9A-Z\-\ ]&quot;)}{1}([ 0-9A-Z&amp;] '\- \., /°\^\(\\ )À È É ì ò ù Ü &quot;;\ \\ /+)*	enumeration	1	enumeration	2	enumeration	3	enumeration	4	enumeration	5	enumeration	6	enumeration	7	enumeration	8	enumeration	9	enumeration	10	enumeration	11	enumeration	12	enumeration	13	enumeration	14	enumeration	15	enumeration	16
Kind	Value																																				
pattern	{([0-9A-Z\-\ ]&quot;)}{1}([ 0-9A-Z&amp;] '\- \., /°\^\(\\ )À È É ì ò ù Ü &quot;;\ \\ /+)*																																				
enumeration	1																																				
enumeration	2																																				
enumeration	3																																				
enumeration	4																																				
enumeration	5																																				
enumeration	6																																				
enumeration	7																																				
enumeration	8																																				
enumeration	9																																				
enumeration	10																																				
enumeration	11																																				
enumeration	12																																				
enumeration	13																																				
enumeration	14																																				
enumeration	15																																				
enumeration	16																																				

enumeration	17
enumeration	18
enumeration	19
enumeration	20
enumeration	21

element **Importi\_Trattenere\_730-4\_Type/AddRegTrattenere/CodiceRegioneConiuge**

diagram		
namespace	urn:www.agenziaentrate.gov.it:specificheTecniche:sco:730	
type	<a href="#">Codice Regione Type</a>	
facets	Kind	Value
	pattern	{([0-9A-Z-])&quot;}{1}([ 0-9A-Z&amp;:] [-\., /° ^\\( \) À É È Ì Ò Ù Û &quot; \\ / +)*
	enumeration	1
	enumeration	2
	enumeration	3
	enumeration	4
	enumeration	5
	enumeration	6
	enumeration	7
	enumeration	8
	enumeration	9
	enumeration	10
	enumeration	11
	enumeration	12
	enumeration	13
	enumeration	14
	enumeration	15
	enumeration	16
	enumeration	17
	enumeration	18
	enumeration	19
	enumeration	20
	enumeration	21

element **Importi\_Trattenere\_730-4\_Type/AddComTrattenere**

diagram		
namespace	urn:www.agenziaentrate.gov.it:specificheTecniche:sco:730	
children	<a href="#">m730:ImportoAddizionale</a> <a href="#">m730:CodiceComuneDichiarante</a> <a href="#">m730:CodiceComuneConiuge</a>	

element **Importi\_Trattenere\_730-4\_Type/AddComTrattenere/ImportoAddizionale**

diagram	
namespace	urn:www.agenziaentrate.gov.it:specificheTecniche:sco:730
type	<a href="#">m730:Importo_730-4</a>
children	<a href="#">m730:ImportoDichiarante</a> <a href="#">m730:ImportoConiuge</a> <a href="#">m730:ImportoTotale</a>

element **Importi\_Trattenere\_730-4\_Type/AddComTrattenere/CodiceComuneDichiarante**

diagram					
namespace	urn:www.agenziaentrate.gov.it:specificheTecniche:sco:730				
type	<a href="#">DatoAN_Type</a>				
facets	<table border="1"> <thead> <tr> <th>Kind</th> <th>Value</th> </tr> </thead> <tbody> <tr> <td>pattern</td> <td>(([0-9A-Z-] &amp;quot;){1}([ 0-9A-Z&amp;amp;] ' \" \\. / ° \"\\( \\) À É È Ì Ò Ù Û &amp;quot;; \\ \\ \\ +)*</td> </tr> </tbody> </table>	Kind	Value	pattern	(([0-9A-Z-] &quot;){1}([ 0-9A-Z&amp;] ' \" \\. / ° \"\\( \\) À É È Ì Ò Ù Û &quot;; \\ \\ \\ +)*
Kind	Value				
pattern	(([0-9A-Z-] &quot;){1}([ 0-9A-Z&amp;] ' \" \\. / ° \"\\( \\) À É È Ì Ò Ù Û &quot;; \\ \\ \\ +)*				

element **Importi\_Trattenere\_730-4\_Type/AddComTrattenere/CodiceComuneConiuge**

diagram					
namespace	urn:www.agenziaentrate.gov.it:specificheTecniche:sco:730				
type	<a href="#">DatoAN_Type</a>				
facets	<table border="1"> <thead> <tr> <th>Kind</th> <th>Value</th> </tr> </thead> <tbody> <tr> <td>pattern</td> <td>(([0-9A-Z-] &amp;quot;){1}([ 0-9A-Z&amp;amp;] ' \" \\. / ° \"\\( \\) À É È Ì Ò Ù Û &amp;quot;; \\ \\ \\ +)*</td> </tr> </tbody> </table>	Kind	Value	pattern	(([0-9A-Z-] &quot;){1}([ 0-9A-Z&amp;] ' \" \\. / ° \"\\( \\) À É È Ì Ò Ù Û &quot;; \\ \\ \\ +)*
Kind	Value				
pattern	(([0-9A-Z-] &quot;){1}([ 0-9A-Z&amp;] ' \" \\. / ° \"\\( \\) À É È Ì Ò Ù Û &quot;; \\ \\ \\ +)*				

element **Importi\_Trattenere\_730-4\_Type/IrpefPrimaRataTrattenere**

diagram	
namespace	urn:www.agenziaentrate.gov.it:specificheTecniche:sco:730
type	<a href="#">m730:Importo_730-4</a>

children	<a href="#">m730:ImportoDichiarante</a> <a href="#">m730:ImportoConiuge</a> <a href="#">m730:ImportoTotale</a>
----------	--

element **Importi\_Trattenere\_730-4\_Type/IrpefSecondaRataTrattenere**

diagram	
namespace	urn:www.agenziaentrate.gov.it:specificheTecniche:sco:730
type	<a href="#">m730:Importo_730-4</a>
children	<a href="#">m730:ImportoDichiarante</a> <a href="#">m730:ImportoConiuge</a> <a href="#">m730:ImportoTotale</a>

element **Importi\_Trattenere\_730-4\_Type/TassSepAccontoTrattenere**

diagram	
namespace	urn:www.agenziaentrate.gov.it:specificheTecniche:sco:730
type	<a href="#">m730:Importo_730-4</a>
children	<a href="#">m730:ImportoDichiarante</a> <a href="#">m730:ImportoConiuge</a> <a href="#">m730:ImportoTotale</a>

element **Importi\_Trattenere\_730-4\_Type/AddComAccontoTrattenere**

diagram	
namespace	urn:www.agenziaentrate.gov.it:specificheTecniche:sco:730
children	<a href="#">m730:ImportoAddizionale</a> <a href="#">m730:CodiceComuneDichiarante</a> <a href="#">m730:CodiceComuneConiuge</a>

element **Importi\_Trattenere\_730-4\_Type/AddComAccontoTrattenere/ImportoAddizionale**

diagram	
namespace	urn:www.agenziaentrate.gov.it:specificheTecniche:sco:730
type	<a href="#">m730:Importo_730-4</a>
children	<a href="#">m730:ImportoDichiarante</a> <a href="#">m730:ImportoConiuge</a> <a href="#">m730:ImportoTotale</a>

element **Importi\_Trattenere\_730-4\_Type/AddComAccontoTrattenere/CodiceComuneDichiarante**

diagram					
namespace	urn:www.agenziaentrate.gov.it:specificheTecniche:sco:730				
type	<a href="#">DatoAN_Type</a>				
facets	<table border="0"> <tr> <td>Kind</td> <td>Value</td> </tr> <tr> <td>pattern</td> <td>(([0-9A-Z-] &amp;quot;){1}([ 0-9A-Z&amp;amp;] ' \" \\. / ^\\(\\) À É È Ì Ò Ù Û &amp;quot; \\ \\ \\ +)*</td> </tr> </table>	Kind	Value	pattern	(([0-9A-Z-] &quot;){1}([ 0-9A-Z&amp;] ' \" \\. / ^\\(\\) À É È Ì Ò Ù Û &quot; \\ \\ \\ +)*
Kind	Value				
pattern	(([0-9A-Z-] &quot;){1}([ 0-9A-Z&amp;] ' \" \\. / ^\\(\\) À É È Ì Ò Ù Û &quot; \\ \\ \\ +)*				

element **Importi\_Trattenere\_730-4\_Type/AddComAccontoTrattenere/CodiceComuneConiuge**

diagram					
namespace	urn:www.agenziaentrate.gov.it:specificheTecniche:sco:730				
type	<a href="#">DatoAN_Type</a>				
facets	<table border="0"> <tr> <td>Kind</td> <td>Value</td> </tr> <tr> <td>pattern</td> <td>(([0-9A-Z-] &amp;quot;){1}([ 0-9A-Z&amp;amp;] ' \" \\. / ^\\(\\) À É È Ì Ò Ù Û &amp;quot; \\ \\ \\ +)*</td> </tr> </table>	Kind	Value	pattern	(([0-9A-Z-] &quot;){1}([ 0-9A-Z&amp;] ' \" \\. / ^\\(\\) À É È Ì Ò Ù Û &quot; \\ \\ \\ +)*
Kind	Value				
pattern	(([0-9A-Z-] &quot;){1}([ 0-9A-Z&amp;] ' \" \\. / ^\\(\\) À É È Ì Ò Ù Û &quot; \\ \\ \\ +)*				

element **Importi\_Trattenere\_730-4\_Type/PremiRisultatoTrattenere**

diagram	
namespace	urn:www.agenziaentrate.gov.it:specificheTecniche:sco:730
type	<a href="#">m730:Importo_730-4</a>

children	<a href="#">m730:ImportoDichiarante</a> <a href="#">m730:ImportoConiuge</a> <a href="#">m730:ImportoTotale</a>
----------	--

element **Importi\_Trattenere\_730-4\_Type/CedolareTrattenere**

diagram	<p>The diagram illustrates the composition of the <code>m730:Importo_730-4</code> element. It is shown as a large dashed box containing three sub-elements: <code>m730:ImportoDichiarante</code>, <code>m730:ImportoConiuge</code>, and <code>m730:ImportoTotale</code>. A dashed box labeled <code>m730:CedolareTrattenere</code> is connected to the main structure via a connector symbol.</p>
namespace	urn:www.agenziaentrate.gov.it:specificheTecniche:sco:730
type	<a href="#">m730:Importo_730-4</a>
children	<a href="#">m730:ImportoDichiarante</a> <a href="#">m730:ImportoConiuge</a> <a href="#">m730:ImportoTotale</a>

element **Importi\_Trattenere\_730-4\_Type/CedolarePrimaRataTrattenere**

diagram	<p>The diagram illustrates the composition of the <code>m730:Importo_730-4</code> element. It is shown as a large dashed box containing three sub-elements: <code>m730:ImportoDichiarante</code>, <code>m730:ImportoConiuge</code>, and <code>m730:ImportoTotale</code>. A dashed box labeled <code>m730:CedolarePrimaRataTrattenere</code> is connected to the main structure via a connector symbol.</p>
namespace	urn:www.agenziaentrate.gov.it:specificheTecniche:sco:730
type	<a href="#">m730:Importo_730-4</a>
children	<a href="#">m730:ImportoDichiarante</a> <a href="#">m730:ImportoConiuge</a> <a href="#">m730:ImportoTotale</a>

element **Importi\_Trattenere\_730-4\_Type/CedolareSecondaRataTrattenere**

diagram	<p>The diagram illustrates the composition of the <code>m730:Importo_730-4</code> element. It is shown as a large dashed box containing three sub-elements: <code>m730:ImportoDichiarante</code>, <code>m730:ImportoConiuge</code>, and <code>m730:ImportoTotale</code>. A dashed box labeled <code>m730:CedolareSecondaRataTrattenere</code> is connected to the main structure via a connector symbol.</p>
namespace	urn:www.agenziaentrate.gov.it:specificheTecniche:sco:730
type	<a href="#">m730:Importo_730-4</a>

children	<a href="#">m730:ImportoDichiarante</a> <a href="#">m730:ImportoConiuge</a> <a href="#">m730:ImportoTotale</a>
----------	--

### complexType **Importo\_730-4**

diagram	
namespace	urn:www.agenziaentrate.gov.it:specificheTecniche:sco:730
children	<a href="#">m730:ImportoDichiarante</a> <a href="#">m730:ImportoConiuge</a> <a href="#">m730:ImportoTotale</a>

### element **Importo\_730-4/ImportoDichiarante**

diagram					
namespace	urn:www.agenziaentrate.gov.it:specificheTecniche:sco:730				
type	<a href="#">DatoNP_Type</a>				
facets	<table border="1"> <tr> <td>Kind</td> <td>Value</td> </tr> <tr> <td>pattern</td> <td>[1-9]{1}[0-9]*</td> </tr> </table>	Kind	Value	pattern	[1-9]{1}[0-9]*
Kind	Value				
pattern	[1-9]{1}[0-9]*				

### element **Importo\_730-4/ImportoConiuge**

diagram					
namespace	urn:www.agenziaentrate.gov.it:specificheTecniche:sco:730				
type	<a href="#">DatoNP_Type</a>				
facets	<table border="1"> <tr> <td>Kind</td> <td>Value</td> </tr> <tr> <td>pattern</td> <td>[1-9]{1}[0-9]*</td> </tr> </table>	Kind	Value	pattern	[1-9]{1}[0-9]*
Kind	Value				
pattern	[1-9]{1}[0-9]*				

### element **Importo\_730-4/ImportoTotale**

diagram					
namespace	urn:www.agenziaentrate.gov.it:specificheTecniche:sco:730				
type	<a href="#">DatoNP_Type</a>				
facets	<table border="1"> <tr> <td>Kind</td> <td>Value</td> </tr> <tr> <td>pattern</td> <td>[1-9]{1}[0-9]*</td> </tr> </table>	Kind	Value	pattern	[1-9]{1}[0-9]*
Kind	Value				
pattern	[1-9]{1}[0-9]*				



### complexType **Imposta\_Lorda\_Type**

diagram	
namespace	urn:www.agenziaentrate.gov.it:specificheTecniche:sco:730
children	<a href="#">m730:RedditoComplessivo</a> <a href="#">m730:DeduzioneAbitazPrincipale</a> <a href="#">m730:OneriDeducibili</a> <a href="#">m730:RedditoImponibile</a> <a href="#">m730:CompensiAttSport</a> <a href="#">m730:ImportoImpostaLorda</a>

### element **Imposta\_Lorda\_Type/RedditoComplessivo**

diagram					
namespace	urn:www.agenziaentrate.gov.it:specificheTecniche:sco:730				
type	<a href="#">DatoNP_Type</a>				
facets	<table border="1"> <tr> <td>Kind</td> <td>Value</td> </tr> <tr> <td>pattern</td> <td>[1-9]{1}[0-9]*</td> </tr> </table>	Kind	Value	pattern	[1-9]{1}[0-9]*
Kind	Value				
pattern	[1-9]{1}[0-9]*				

### element **Imposta\_Lorda\_Type/DeduzioneAbitazPrincipale**

diagram					
namespace	urn:www.agenziaentrate.gov.it:specificheTecniche:sco:730				
type	<a href="#">DatoNP_Type</a>				
facets	<table border="1"> <tr> <td>Kind</td> <td>Value</td> </tr> <tr> <td>pattern</td> <td>[1-9]{1}[0-9]*</td> </tr> </table>	Kind	Value	pattern	[1-9]{1}[0-9]*
Kind	Value				
pattern	[1-9]{1}[0-9]*				

### element **Imposta\_Lorda\_Type/OneriDeducibili**

diagram					
namespace	urn:www.agenziaentrate.gov.it:specificheTecniche:sco:730				
type	<a href="#">DatoNP_Type</a>				
facets	<table border="1"> <tr> <td>Kind</td> <td>Value</td> </tr> <tr> <td>pattern</td> <td>[1-9]{1}[0-9]*</td> </tr> </table>	Kind	Value	pattern	[1-9]{1}[0-9]*
Kind	Value				
pattern	[1-9]{1}[0-9]*				

### element **Imposta\_Lorda\_Type/Redditolmponibile**

diagram	
namespace	urn:www.agenziaentrate.gov.it:specificheTecniche:sco:730
type	<a href="#">DatoNP_Type</a>
facets	Kind Value pattern [1-9]{1}[0-9]*

### element **Imposta\_Lorda\_Type/CompensiAttSport**

diagram	
namespace	urn:www.agenziaentrate.gov.it:specificheTecniche:sco:730
type	<a href="#">DatoNP_Type</a>
facets	Kind Value pattern [1-9]{1}[0-9]*

### element **Imposta\_Lorda\_Type/ImportolmpostaLorda**

diagram	
namespace	urn:www.agenziaentrate.gov.it:specificheTecniche:sco:730
type	<a href="#">DatoNP_Type</a>
facets	Kind Value pattern [1-9]{1}[0-9]*

complexType **Imposta\_Netta\_Type**

<p>diagram</p>	
<p>namespace</p>	<p>urn:www.agenziaentrate.gov.it:specificheTecniche:sco:730</p>
<p>children</p>	<p><a href="#">m730:ImportoImpostaNetta</a> <a href="#">m730:CredAltriSisma</a> <a href="#">m730:CredAbitazSisma</a> <a href="#">m730:CredImpEstere</a>  <a href="#">m730:CredErogCultura</a> <a href="#">m730:CredErogScuola</a> <a href="#">m730:CredVideosorveglianza</a> <a href="#">m730:CredCanNonPerc</a>  <a href="#">m730:CredDetrazIncapienti</a> <a href="#">m730:Ritenute</a> <a href="#">m730:Differenza</a> <a href="#">m730:EccedenzaIrpef</a> <a href="#">m730:AccontiVersati</a>  <a href="#">m730:RestituzioneBonus</a> <a href="#">m730:CredRimborsatiSost</a> <a href="#">m730:BonusIrpefSpettante</a> <a href="#">m730:BonusIrpefRiconosciuto</a>  <a href="#">m730:RestituzioneBonusIrpef</a></p>

element **Imposta\_Netta\_Type/ImportoImpostaNetta**

<p>diagram</p>	
<p>namespace</p>	<p>urn:www.agenziaentrate.gov.it:specificheTecniche:sco:730</p>

type	<a href="#">DatoNP_Type</a>
facets	Kind Value pattern [1-9]{1}[0-9]*

#### element **Imposta\_Netta\_Type/CredAltriSisma**

diagram	
namespace	urn:www.agenziaentrate.gov.it:specificheTecniche:sco:730
type	<a href="#">DatoNP_Type</a>
facets	Kind Value pattern [1-9]{1}[0-9]*

#### element **Imposta\_Netta\_Type/CredAbitazSisma**

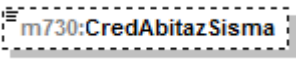
diagram	
namespace	urn:www.agenziaentrate.gov.it:specificheTecniche:sco:730
type	<a href="#">DatoNP_Type</a>
facets	Kind Value pattern [1-9]{1}[0-9]*

#### element **Imposta\_Netta\_Type/CredImpEstere**

diagram	
namespace	urn:www.agenziaentrate.gov.it:specificheTecniche:sco:730
type	<a href="#">DatoNP_Type</a>
facets	Kind Value pattern [1-9]{1}[0-9]*

#### element **Imposta\_Netta\_Type/CredErogCultura**

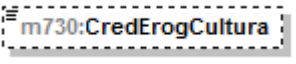
diagram	
namespace	urn:www.agenziaentrate.gov.it:specificheTecniche:sco:730
type	<a href="#">DatoNP_Type</a>
facets	Kind Value pattern [1-9]{1}[0-9]*

#### element **Imposta\_Netta\_Type/CredErogScuola**

diagram	
---------	---

namespace	urn:www.agenziaentrate.gov.it:specificheTecniche:sco:730
type	<a href="#">DatoNP_Type</a>
facets	Kind Value pattern [1-9]{1}[0-9]*

#### element **Imposta\_Netta\_Type/CredVideosorveglianza**

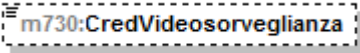
diagram	
namespace	urn:www.agenziaentrate.gov.it:specificheTecniche:sco:730
type	<a href="#">DatoNP_Type</a>
facets	Kind Value pattern [1-9]{1}[0-9]*

#### element **Imposta\_Netta\_Type/CredCanNonPerc**

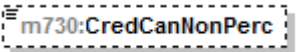
diagram	
namespace	urn:www.agenziaentrate.gov.it:specificheTecniche:sco:730
type	<a href="#">DatoNP_Type</a>
facets	Kind Value pattern [1-9]{1}[0-9]*

#### element **Imposta\_Netta\_Type/CredDetrazIncapienti**

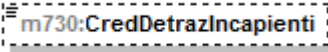
diagram	
namespace	urn:www.agenziaentrate.gov.it:specificheTecniche:sco:730
type	<a href="#">DatoNP_Type</a>
facets	Kind Value pattern [1-9]{1}[0-9]*

#### element **Imposta\_Netta\_Type/Ritenute**

diagram	
namespace	urn:www.agenziaentrate.gov.it:specificheTecniche:sco:730
type	<a href="#">DatoNP_Type</a>
facets	Kind Value pattern [1-9]{1}[0-9]*

**element Imposta\_Netta\_Type/Differenza**

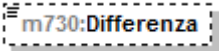
diagram	
namespace	urn:www.agenziaentrate.gov.it:specificheTecniche:sco:730
type	<a href="#">DatoNU_Type</a>
facets	Kind Value pattern $(\-[1-9])\{1\}[0-9]^*$

**element Imposta\_Netta\_Type/Eccedenzalrpef**

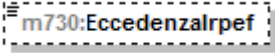
diagram	
namespace	urn:www.agenziaentrate.gov.it:specificheTecniche:sco:730
type	<a href="#">DatoNU_Type</a>
facets	Kind Value pattern $(\-[1-9])\{1\}[0-9]^*$

**element Imposta\_Netta\_Type/AccontiVersati**

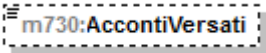
diagram	
namespace	urn:www.agenziaentrate.gov.it:specificheTecniche:sco:730
type	<a href="#">DatoNP_Type</a>
facets	Kind Value pattern $[1-9]\{1\}[0-9]^*$

**element Imposta\_Netta\_Type/RestituzioneBonus**

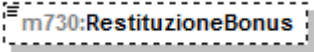
diagram	
namespace	urn:www.agenziaentrate.gov.it:specificheTecniche:sco:730
type	<a href="#">DatoNP_Type</a>
facets	Kind Value pattern $[1-9]\{1\}[0-9]^*$

**element Imposta\_Netta\_Type/CredRimborsatiSost**

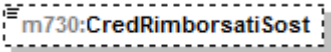
diagram	
namespace	urn:www.agenziaentrate.gov.it:specificheTecniche:sco:730
type	<a href="#">DatoNP_Type</a>
facets	Kind Value pattern $[1-9]\{1\}[0-9]^*$

element **Imposta\_Netta\_Type/BonuslrpefSpettante**

diagram	
namespace	urn:www.agenziaentrate.gov.it:specificheTecniche:sco:730
type	<a href="#">DatoNP_Type</a>
facets	Kind Value pattern [1-9]{1}[0-9]*

element **Imposta\_Netta\_Type/BonuslrpefRiconosciuto**

diagram	
namespace	urn:www.agenziaentrate.gov.it:specificheTecniche:sco:730
type	<a href="#">DatoNP_Type</a>
facets	Kind Value pattern [1-9]{1}[0-9]*

element **Imposta\_Netta\_Type/RestituzioneBonuslrpef**

diagram	
namespace	urn:www.agenziaentrate.gov.it:specificheTecniche:sco:730
type	<a href="#">DatoNP_Type</a>
facets	Kind Value pattern [1-9]{1}[0-9]*

complexType **Imposte\_Rimborsate\_Type**

diagram	
namespace	urn:www.agenziaentrate.gov.it:specificheTecniche:sco:730
children	<a href="#">m730:TipoReddito</a> <a href="#">m730:TassazioneSeparata</a>

element **Imposte\_Rimborsate\_Type/TipoReddito**

diagram	
namespace	urn:www.agenziaentrate.gov.it:specificheTecniche:sco:730
type	<a href="#">m730:Tipo_Reddito_Da1a8_Type</a>
facets	Kind Value pattern [1-9]{1}[0-9]*

	enumeration	1
	enumeration	2
	enumeration	3
	enumeration	4
	enumeration	5
	enumeration	6
	enumeration	7
	enumeration	8

**element Imposte\_Rimborsate\_Type/TassazioneSeparata**

diagram	
namespace	urn:www.agenziaentrate.gov.it:specificheTecniche:sco:730
type	<a href="#">m730:Tassazione_Separata_Type</a>
children	<a href="#">m730:Opzione</a> <a href="#">m730:Anno</a> <a href="#">m730:RedditoRitenute</a>

**complexType Inquilini\_Abitazione\_Principale\_Type**

diagram	
namespace	urn:www.agenziaentrate.gov.it:specificheTecniche:sco:730
children	<a href="#">m730:Tipologia</a> <a href="#">m730:GiorniPercentuale</a>

**element Inquilini\_Abitazione\_Principale\_Type/Tipologia**

diagram											
namespace	urn:www.agenziaentrate.gov.it:specificheTecniche:sco:730										
type	<a href="#">m730:Tipo_Inquilino_Type</a>										
facets	<table border="1"> <thead> <tr> <th>Kind</th> <th>Value</th> </tr> </thead> <tbody> <tr> <td>pattern</td> <td>[1-9]{1}[0-9]*</td> </tr> <tr> <td>enumeration</td> <td>1</td> </tr> <tr> <td>enumeration</td> <td>2</td> </tr> <tr> <td>enumeration</td> <td>3</td> </tr> </tbody> </table>	Kind	Value	pattern	[1-9]{1}[0-9]*	enumeration	1	enumeration	2	enumeration	3
Kind	Value										
pattern	[1-9]{1}[0-9]*										
enumeration	1										
enumeration	2										
enumeration	3										



element **Inquilini\_Abitazione\_Principale\_Type/GiorniPercentuale**

diagram	<p>The diagram shows a box labeled 'm730:GiorniPercentuale' connected to a sequence container (a rounded rectangle with three dots). This container is linked to two child elements: 'm730:Giorni' and 'm730:Percentuale'. The entire structure is enclosed in a dashed yellow box labeled 'm730:Giorni_Percentuale_Type'.</p>
namespace	urn:www.agenziaentrate.gov.it:specificheTecniche:sco:730
type	<a href="#">m730:Giorni_Percentuale_Type</a>
children	<a href="#">m730:Giorni</a> <a href="#">m730:Percentuale</a>

complexType **Intervento\_Recupero\_Patrimonio\_Edilizio\_Type**

diagram	<p>The diagram shows a box labeled 'Intervento_Recupero_Patrimoni...' connected to a sequence container (a rounded rectangle with three dots). This container is linked to eight child elements: 'm730:Anno', 'm730:Periodo', 'm730:CodiceFiscale', 'm730:CasellaInterventiParticolari', 'm730:CodiceSituazioniParticolari', 'm730:Rate10', 'm730:Spesa', and 'm730:NOrdineImmobile'. All child elements are shown in dashed boxes.</p>
namespace	urn:www.agenziaentrate.gov.it:specificheTecniche:sco:730
children	<a href="#">m730:Anno</a> <a href="#">m730:Periodo</a> <a href="#">m730:CodiceFiscale</a> <a href="#">m730:CasellaInterventiParticolari</a> <a href="#">m730:CodiceSituazioniParticolari</a> <a href="#">m730:Rate10</a> <a href="#">m730:Spesa</a> <a href="#">m730:NOrdineImmobile</a>

element **Intervento\_Recupero\_Patrimonio\_Edilizio\_Type/Anno**

diagram	<p>The diagram shows a dashed box labeled 'm730:Anno'.</p>																
namespace	urn:www.agenziaentrate.gov.it:specificheTecniche:sco:730																
type	<a href="#">m730:Anno_Recupero_Patrimonio_Edilizio_Type</a>																
facets	<table border="1"> <thead> <tr> <th>Kind</th> <th>Value</th> </tr> </thead> <tbody> <tr> <td>pattern</td> <td>[1-9]{1}[0-9]*</td> </tr> <tr> <td>enumeration</td> <td>2008</td> </tr> <tr> <td>enumeration</td> <td>2009</td> </tr> <tr> <td>enumeration</td> <td>2010</td> </tr> <tr> <td>enumeration</td> <td>2011</td> </tr> <tr> <td>enumeration</td> <td>2012</td> </tr> <tr> <td>enumeration</td> <td>2013</td> </tr> </tbody> </table>	Kind	Value	pattern	[1-9]{1}[0-9]*	enumeration	2008	enumeration	2009	enumeration	2010	enumeration	2011	enumeration	2012	enumeration	2013
Kind	Value																
pattern	[1-9]{1}[0-9]*																
enumeration	2008																
enumeration	2009																
enumeration	2010																
enumeration	2011																
enumeration	2012																
enumeration	2013																

	enumeration	2014
	enumeration	2015
	enumeration	2016
	enumeration	2017

element **Intervento\_Ricupero\_Patrimonio\_Edilizio\_Type/Periodo**

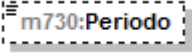
diagram																									
namespace	urn:www.agenziaentrate.gov.it:specificheTecniche:sco:730																								
type	<a href="#">m730:Periodo Spese Ristrutturazione Type</a>																								
facets	<table border="1"> <thead> <tr> <th>Kind</th> <th>Value</th> </tr> </thead> <tbody> <tr> <td>pattern</td> <td>[1-9]{1}[0-9]*</td> </tr> <tr> <td>enumeration</td> <td>2</td> </tr> <tr> <td>enumeration</td> <td>3</td> </tr> <tr> <td>enumeration</td> <td>4</td> </tr> <tr> <td>enumeration</td> <td>5</td> </tr> <tr> <td>enumeration</td> <td>6</td> </tr> <tr> <td>enumeration</td> <td>7</td> </tr> <tr> <td>enumeration</td> <td>8</td> </tr> <tr> <td>enumeration</td> <td>9</td> </tr> <tr> <td>enumeration</td> <td>10</td> </tr> <tr> <td>enumeration</td> <td>11</td> </tr> </tbody> </table>	Kind	Value	pattern	[1-9]{1}[0-9]*	enumeration	2	enumeration	3	enumeration	4	enumeration	5	enumeration	6	enumeration	7	enumeration	8	enumeration	9	enumeration	10	enumeration	11
Kind	Value																								
pattern	[1-9]{1}[0-9]*																								
enumeration	2																								
enumeration	3																								
enumeration	4																								
enumeration	5																								
enumeration	6																								
enumeration	7																								
enumeration	8																								
enumeration	9																								
enumeration	10																								
enumeration	11																								

element **Intervento\_Ricupero\_Patrimonio\_Edilizio\_Type/CodiceFiscale**

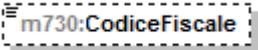
diagram					
namespace	urn:www.agenziaentrate.gov.it:specificheTecniche:sco:730				
type	<a href="#">DatoCF Type</a>				
facets	<table border="1"> <thead> <tr> <th>Kind</th> <th>Value</th> </tr> </thead> <tbody> <tr> <td>pattern</td> <td>[0-9]{11}[A-Z]{6}[0-9LMNPQRSTUVWXYZ]{2}[A-Z]{1}[0-9LMNPQRSTUVWXYZ]{2}[A-Z]{1}[0-9LMNPQRSTUVWXYZ]{3}[A-Z]{1}</td> </tr> </tbody> </table>	Kind	Value	pattern	[0-9]{11}[A-Z]{6}[0-9LMNPQRSTUVWXYZ]{2}[A-Z]{1}[0-9LMNPQRSTUVWXYZ]{2}[A-Z]{1}[0-9LMNPQRSTUVWXYZ]{3}[A-Z]{1}
Kind	Value				
pattern	[0-9]{11}[A-Z]{6}[0-9LMNPQRSTUVWXYZ]{2}[A-Z]{1}[0-9LMNPQRSTUVWXYZ]{2}[A-Z]{1}[0-9LMNPQRSTUVWXYZ]{3}[A-Z]{1}				

element **Intervento\_Ricupero\_Patrimonio\_Edilizio\_Type/CasellaInterventiParticolari**

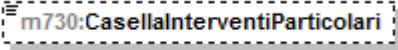
diagram									
namespace	urn:www.agenziaentrate.gov.it:specificheTecniche:sco:730								
type	restriction of <a href="#">DatoN1 Type</a>								
facets	<table border="1"> <thead> <tr> <th>Kind</th> <th>Value</th> </tr> </thead> <tbody> <tr> <td>pattern</td> <td>[1-9]</td> </tr> <tr> <td>enumeration</td> <td>1</td> </tr> <tr> <td>enumeration</td> <td>4</td> </tr> </tbody> </table>	Kind	Value	pattern	[1-9]	enumeration	1	enumeration	4
Kind	Value								
pattern	[1-9]								
enumeration	1								
enumeration	4								

element **Intervento\_Ricupero\_Patrimonio\_Edilizio\_Type/CodiceSituazioniParticolari**

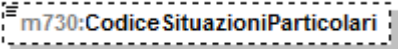
diagram	
namespace	urn:www.agenziaentrate.gov.it:specificheTecniche:sco:730

type	restriction of <a href="#">DatoN1_Type</a>						
facets	<table> <tr> <td>Kind</td> <td>Value</td> </tr> <tr> <td>pattern</td> <td>[1-9]</td> </tr> <tr> <td>enumeration</td> <td>4</td> </tr> </table>	Kind	Value	pattern	[1-9]	enumeration	4
Kind	Value						
pattern	[1-9]						
enumeration	4						

#### element **Intervento\_Ricupero\_Patrimonio\_Edilizio\_Type/Rate10**

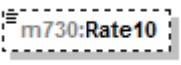
diagram																									
namespace	urn:www.agenziaentrate.gov.it:specificheTecniche:sco:730																								
type	<a href="#">m730:Rate10_Type</a>																								
facets	<table> <tr> <td>Kind</td> <td>Value</td> </tr> <tr> <td>pattern</td> <td>[1-9]{1}[0-9]*</td> </tr> <tr> <td>enumeration</td> <td>1</td> </tr> <tr> <td>enumeration</td> <td>2</td> </tr> <tr> <td>enumeration</td> <td>3</td> </tr> <tr> <td>enumeration</td> <td>4</td> </tr> <tr> <td>enumeration</td> <td>5</td> </tr> <tr> <td>enumeration</td> <td>6</td> </tr> <tr> <td>enumeration</td> <td>7</td> </tr> <tr> <td>enumeration</td> <td>8</td> </tr> <tr> <td>enumeration</td> <td>9</td> </tr> <tr> <td>enumeration</td> <td>10</td> </tr> </table>	Kind	Value	pattern	[1-9]{1}[0-9]*	enumeration	1	enumeration	2	enumeration	3	enumeration	4	enumeration	5	enumeration	6	enumeration	7	enumeration	8	enumeration	9	enumeration	10
Kind	Value																								
pattern	[1-9]{1}[0-9]*																								
enumeration	1																								
enumeration	2																								
enumeration	3																								
enumeration	4																								
enumeration	5																								
enumeration	6																								
enumeration	7																								
enumeration	8																								
enumeration	9																								
enumeration	10																								

#### element **Intervento\_Ricupero\_Patrimonio\_Edilizio\_Type/Spesa**

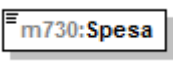
diagram					
namespace	urn:www.agenziaentrate.gov.it:specificheTecniche:sco:730				
type	<a href="#">DatoNP_Type</a>				
facets	<table> <tr> <td>Kind</td> <td>Value</td> </tr> <tr> <td>pattern</td> <td>[1-9]{1}[0-9]*</td> </tr> </table>	Kind	Value	pattern	[1-9]{1}[0-9]*
Kind	Value				
pattern	[1-9]{1}[0-9]*				

#### element **Intervento\_Ricupero\_Patrimonio\_Edilizio\_Type/NOrdineImmobile**

diagram					
namespace	urn:www.agenziaentrate.gov.it:specificheTecniche:sco:730				
type	<a href="#">DatoNP_Type</a>				
facets	<table> <tr> <td>Kind</td> <td>Value</td> </tr> <tr> <td>pattern</td> <td>[1-9]{1}[0-9]*</td> </tr> </table>	Kind	Value	pattern	[1-9]{1}[0-9]*
Kind	Value				
pattern	[1-9]{1}[0-9]*				

complexType **Intervento\_Risparmio\_Energetico\_Type**

diagram	
namespace	urn:www.agenziaentrate.gov.it:specificheTecniche:sco:730
children	<a href="#">m730:TipoIntervento</a> <a href="#">m730:Anno</a> <a href="#">m730:Periodo2013</a> <a href="#">m730:CasiParticolari</a> <a href="#">m730:RideterminazioneRate</a> <a href="#">m730:NumeroRata</a> <a href="#">m730:Spesa</a>

element **Intervento\_Risparmio\_Energetico\_Type/Tipointervento**

diagram																							
namespace	urn:www.agenziaentrate.gov.it:specificheTecniche:sco:730																						
type	<a href="#">m730:Tipo_Intervento_Type</a>																						
facets	<table border="1"> <thead> <tr> <th>Kind</th> <th>Value</th> </tr> </thead> <tbody> <tr> <td>pattern</td> <td>[1-9]</td> </tr> <tr> <td>enumeration</td> <td>1</td> </tr> <tr> <td>enumeration</td> <td>2</td> </tr> <tr> <td>enumeration</td> <td>3</td> </tr> <tr> <td>enumeration</td> <td>4</td> </tr> <tr> <td>enumeration</td> <td>5</td> </tr> <tr> <td>enumeration</td> <td>6</td> </tr> <tr> <td>enumeration</td> <td>7</td> </tr> <tr> <td>enumeration</td> <td>8</td> </tr> <tr> <td>enumeration</td> <td>9</td> </tr> </tbody> </table>	Kind	Value	pattern	[1-9]	enumeration	1	enumeration	2	enumeration	3	enumeration	4	enumeration	5	enumeration	6	enumeration	7	enumeration	8	enumeration	9
Kind	Value																						
pattern	[1-9]																						
enumeration	1																						
enumeration	2																						
enumeration	3																						
enumeration	4																						
enumeration	5																						
enumeration	6																						
enumeration	7																						
enumeration	8																						
enumeration	9																						

element **Intervento\_Risparmio\_Energetico\_Type/Anno**

diagram																	
namespace	urn:www.agenziaentrate.gov.it:specificheTecniche:sco:730																
type	<a href="#">m730:Anno_Risparmio_Energetico_Type</a>																
facets	<table border="1"> <thead> <tr> <th>Kind</th> <th>Value</th> </tr> </thead> <tbody> <tr> <td>pattern</td> <td>[1-9]{1}[0-9]*</td> </tr> <tr> <td>enumeration</td> <td>2008</td> </tr> <tr> <td>enumeration</td> <td>2011</td> </tr> <tr> <td>enumeration</td> <td>2012</td> </tr> <tr> <td>enumeration</td> <td>2013</td> </tr> <tr> <td>enumeration</td> <td>2014</td> </tr> <tr> <td>enumeration</td> <td>2015</td> </tr> </tbody> </table>	Kind	Value	pattern	[1-9]{1}[0-9]*	enumeration	2008	enumeration	2011	enumeration	2012	enumeration	2013	enumeration	2014	enumeration	2015
Kind	Value																
pattern	[1-9]{1}[0-9]*																
enumeration	2008																
enumeration	2011																
enumeration	2012																
enumeration	2013																
enumeration	2014																
enumeration	2015																

	enumeration 2016
	enumeration 2017

**element Intervento\_Risparmio\_Energetico\_Type/Periodo2013**

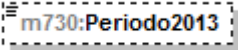
diagram									
namespace	urn:www.agenziaentrate.gov.it:specificheTecniche:sco:730								
type	restriction of <a href="#">DatoN1_Type</a>								
facets	<table border="1"> <thead> <tr> <th>Kind</th> <th>Value</th> </tr> </thead> <tbody> <tr> <td>pattern</td> <td>[1-9]</td> </tr> <tr> <td>enumeration</td> <td>1</td> </tr> <tr> <td>enumeration</td> <td>2</td> </tr> </tbody> </table>	Kind	Value	pattern	[1-9]	enumeration	1	enumeration	2
Kind	Value								
pattern	[1-9]								
enumeration	1								
enumeration	2								

**element Intervento\_Risparmio\_Energetico\_Type/CasiParticolari**

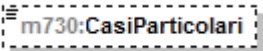
diagram											
namespace	urn:www.agenziaentrate.gov.it:specificheTecniche:sco:730										
type	<a href="#">m730:Casi_Particolari_Risp_Ener_Type</a>										
facets	<table border="1"> <thead> <tr> <th>Kind</th> <th>Value</th> </tr> </thead> <tbody> <tr> <td>pattern</td> <td>[1-9]</td> </tr> <tr> <td>enumeration</td> <td>1</td> </tr> <tr> <td>enumeration</td> <td>2</td> </tr> <tr> <td>enumeration</td> <td>3</td> </tr> </tbody> </table>	Kind	Value	pattern	[1-9]	enumeration	1	enumeration	2	enumeration	3
Kind	Value										
pattern	[1-9]										
enumeration	1										
enumeration	2										
enumeration	3										

**element Intervento\_Risparmio\_Energetico\_Type/RideterminazioneRate**

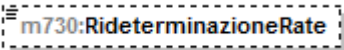
diagram																			
namespace	urn:www.agenziaentrate.gov.it:specificheTecniche:sco:730																		
type	<a href="#">m730:Rate_Risparmio_Energetico_Type</a>																		
facets	<table border="1"> <thead> <tr> <th>Kind</th> <th>Value</th> </tr> </thead> <tbody> <tr> <td>pattern</td> <td>[1-9]{1}[0-9]*</td> </tr> <tr> <td>enumeration</td> <td>4</td> </tr> <tr> <td>enumeration</td> <td>5</td> </tr> <tr> <td>enumeration</td> <td>6</td> </tr> <tr> <td>enumeration</td> <td>7</td> </tr> <tr> <td>enumeration</td> <td>8</td> </tr> <tr> <td>enumeration</td> <td>9</td> </tr> <tr> <td>enumeration</td> <td>10</td> </tr> </tbody> </table>	Kind	Value	pattern	[1-9]{1}[0-9]*	enumeration	4	enumeration	5	enumeration	6	enumeration	7	enumeration	8	enumeration	9	enumeration	10
Kind	Value																		
pattern	[1-9]{1}[0-9]*																		
enumeration	4																		
enumeration	5																		
enumeration	6																		
enumeration	7																		
enumeration	8																		
enumeration	9																		
enumeration	10																		

**element Intervento\_Risparmio\_Energetico\_Type/NumeroRata**

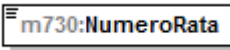
diagram	
namespace	urn:www.agenziaentrate.gov.it:specificheTecniche:sco:730
type	<a href="#">m730:Numero_Rata_Risparmio_Energetico_Type</a>

facets	Kind	Value
	pattern	[1-9]{1}[0-9]*
	enumeration	1
	enumeration	2
	enumeration	3
	enumeration	4
	enumeration	5
	enumeration	6
	enumeration	7
	enumeration	10

#### element Intervento\_Risparmio\_Energetico\_Type/Spesa

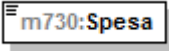
diagram					
namespace	urn:www.agenziaentrate.gov.it:specificheTecniche:sco:730				
type	<a href="#">DatoNP_Type</a>				
facets	<table border="1"> <tr> <td>Kind</td> <td>Value</td> </tr> <tr> <td>pattern</td> <td>[1-9]{1}[0-9]*</td> </tr> </table>	Kind	Value	pattern	[1-9]{1}[0-9]*
Kind	Value				
pattern	[1-9]{1}[0-9]*				

#### complexType Iva\_Acquisto\_Abitazione\_Type

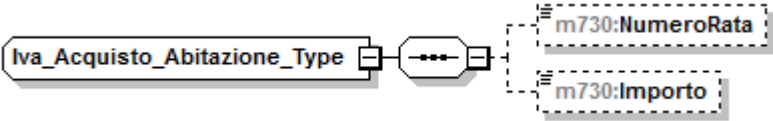
diagram	
namespace	urn:www.agenziaentrate.gov.it:specificheTecniche:sco:730
children	<a href="#">m730:NumeroRata</a> <a href="#">m730:Importo</a>

#### element Iva\_Acquisto\_Abitazione\_Type/NumeroRata

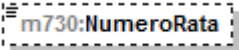
diagram									
namespace	urn:www.agenziaentrate.gov.it:specificheTecniche:sco:730								
type	restriction of <a href="#">DatoNP_Type</a>								
facets	<table border="1"> <tr> <td>Kind</td> <td>Value</td> </tr> <tr> <td>pattern</td> <td>[1-9]{1}[0-9]*</td> </tr> <tr> <td>enumeration</td> <td>1</td> </tr> <tr> <td>enumeration</td> <td>2</td> </tr> </table>	Kind	Value	pattern	[1-9]{1}[0-9]*	enumeration	1	enumeration	2
Kind	Value								
pattern	[1-9]{1}[0-9]*								
enumeration	1								
enumeration	2								

#### element Iva\_Acquisto\_Abitazione\_Type/Importo

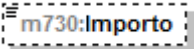
diagram					
namespace	urn:www.agenziaentrate.gov.it:specificheTecniche:sco:730				
type	<a href="#">DatoNP_Type</a>				
facets	<table border="1"> <tr> <td>Kind</td> <td>Value</td> </tr> <tr> <td>pattern</td> <td>[1-9]{1}[0-9]*</td> </tr> </table>	Kind	Value	pattern	[1-9]{1}[0-9]*
Kind	Value				
pattern	[1-9]{1}[0-9]*				

### complexType Lavoro\_Dipendente\_Type

diagram	
namespace	urn:www.agenziaentrate.gov.it:specificheTecniche:sco:730
children	<a href="#">m730:TipologiaReddito</a> <a href="#">m730:TipoContratto</a> <a href="#">m730:Reddito</a>

### element Lavoro\_Dipendente\_Type/TipologiaReddito

diagram																					
namespace	urn:www.agenziaentrate.gov.it:specificheTecniche:sco:730																				
type	restriction of <a href="#">DatoN1_Type</a>																				
facets	<table border="1"> <thead> <tr> <th>Kind</th> <th>Value</th> </tr> </thead> <tbody> <tr> <td>pattern</td> <td>[1-9]</td> </tr> <tr> <td>enumeration</td> <td>1</td> </tr> <tr> <td>enumeration</td> <td>2</td> </tr> <tr> <td>enumeration</td> <td>3</td> </tr> <tr> <td>enumeration</td> <td>4</td> </tr> <tr> <td>enumeration</td> <td>5</td> </tr> <tr> <td>enumeration</td> <td>6</td> </tr> <tr> <td>enumeration</td> <td>7</td> </tr> <tr> <td>enumeration</td> <td>8</td> </tr> </tbody> </table>	Kind	Value	pattern	[1-9]	enumeration	1	enumeration	2	enumeration	3	enumeration	4	enumeration	5	enumeration	6	enumeration	7	enumeration	8
Kind	Value																				
pattern	[1-9]																				
enumeration	1																				
enumeration	2																				
enumeration	3																				
enumeration	4																				
enumeration	5																				
enumeration	6																				
enumeration	7																				
enumeration	8																				

### element Lavoro\_Dipendente\_Type/TipoContratto

diagram									
namespace	urn:www.agenziaentrate.gov.it:specificheTecniche:sco:730								
type	<a href="#">m730:Indeterminato_Determinato_Type</a>								
facets	<table border="1"> <thead> <tr> <th>Kind</th> <th>Value</th> </tr> </thead> <tbody> <tr> <td>pattern</td> <td>[1-9]</td> </tr> <tr> <td>enumeration</td> <td>1</td> </tr> <tr> <td>enumeration</td> <td>2</td> </tr> </tbody> </table>	Kind	Value	pattern	[1-9]	enumeration	1	enumeration	2
Kind	Value								
pattern	[1-9]								
enumeration	1								
enumeration	2								

### element Lavoro\_Dipendente\_Type/Reddito

diagram					
namespace	urn:www.agenziaentrate.gov.it:specificheTecniche:sco:730				
type	<a href="#">DatoNP_Type</a>				
facets	<table border="1"> <thead> <tr> <th>Kind</th> <th>Value</th> </tr> </thead> <tbody> <tr> <td></td> <td></td> </tr> </tbody> </table>	Kind	Value		
Kind	Value				

pattern	[1-9]{1}[0-9]*
---------	----------------

### complexType Locazioni\_Brevi\_Type

diagram	
namespace	urn:www.agenziaentrate.gov.it:specificheTecniche:sco:730
children	<a href="#">m730:Ritenute</a>

### element Locazioni\_Brevi\_Type/Ritenute

diagram	
namespace	urn:www.agenziaentrate.gov.it:specificheTecniche:sco:730
type	<a href="#">DatoNP_Type</a>
facets	Kind Value pattern [1-9]{1}[0-9]*

### complexType Misura\_Acconti\_Type

diagram	
namespace	urn:www.agenziaentrate.gov.it:specificheTecniche:sco:730
children	<a href="#">m730:IrpefMisuralInferiore</a> <a href="#">m730:AddComunaleMisuralInferiore</a> <a href="#">m730:CedolareSeccaMisuralInferiore</a> <a href="#">m730:NumeroRate</a>

### element Misura\_Acconti\_Type/IrpefMisuralInferiore

diagram	
namespace	urn:www.agenziaentrate.gov.it:specificheTecniche:sco:730
type	<a href="#">m730:Casella_Acconto_Type</a>
children	<a href="#">m730:Casella</a> <a href="#">m730:ImportoMisuralInferiore</a>



element **Misura\_Aconti\_Type/AddComunaleMisuralInferiore**

diagram	
namespace	urn:www.agenziaentrate.gov.it:specificheTecniche:sco:730
type	<a href="#">m730:Casella_Aconto_Type</a>
children	<a href="#">m730:Casella</a> <a href="#">m730:ImportoMisuralInferiore</a>

element **Misura\_Aconti\_Type/CedolareSeccaMisuralInferiore**

diagram	
namespace	urn:www.agenziaentrate.gov.it:specificheTecniche:sco:730
type	<a href="#">m730:Casella_Aconto_Type</a>
children	<a href="#">m730:Casella</a> <a href="#">m730:ImportoMisuralInferiore</a>

element **Misura\_Aconti\_Type/NumeroRate**

diagram																	
namespace	urn:www.agenziaentrate.gov.it:specificheTecniche:sco:730																
type	restriction of <a href="#">DatoN1_Type</a>																
facets	<table border="0"> <thead> <tr> <th>Kind</th> <th>Value</th> </tr> </thead> <tbody> <tr> <td>pattern</td> <td>[1-9]</td> </tr> <tr> <td>enumeration</td> <td>2</td> </tr> <tr> <td>enumeration</td> <td>3</td> </tr> <tr> <td>enumeration</td> <td>4</td> </tr> <tr> <td>enumeration</td> <td>5</td> </tr> <tr> <td>enumeration</td> <td>6</td> </tr> <tr> <td>enumeration</td> <td>7</td> </tr> </tbody> </table>	Kind	Value	pattern	[1-9]	enumeration	2	enumeration	3	enumeration	4	enumeration	5	enumeration	6	enumeration	7
Kind	Value																
pattern	[1-9]																
enumeration	2																
enumeration	3																
enumeration	4																
enumeration	5																
enumeration	6																
enumeration	7																

complexType **Mod730\_Integrativo\_Type**

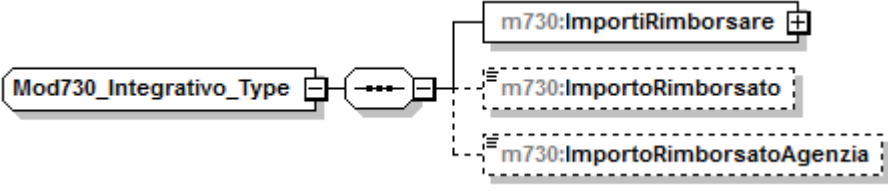
diagram	
namespace	urn:www.agenziaentrate.gov.it:specificheTecniche:sco:730
children	<a href="#">m730:ImportiRimborsare</a> <a href="#">m730:ImportoRimborsato</a> <a href="#">m730:ImportoRimborsatoAgenzia</a>

element **Mod730\_Integrativo\_Type/ImportiRimborsare**

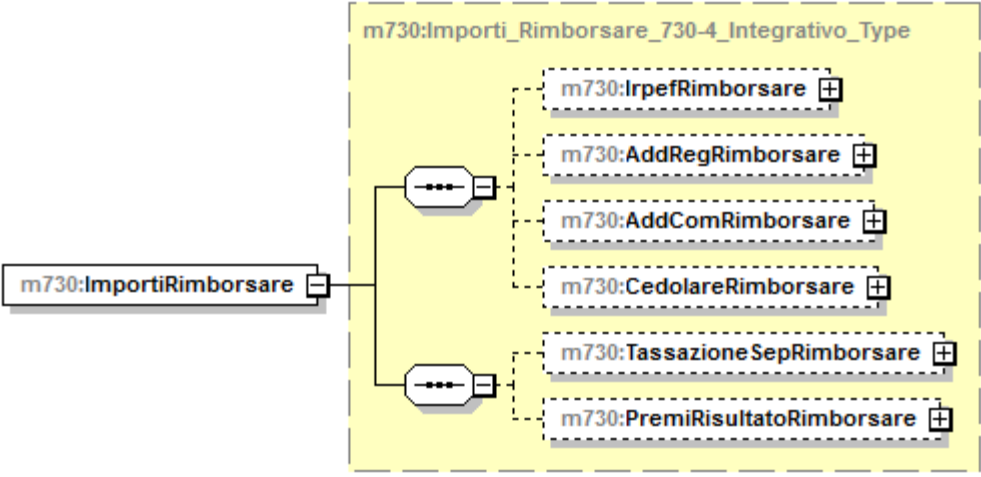
diagram	
namespace	urn:www.agenziaentrate.gov.it:specificheTecniche:sco:730
type	<a href="#">m730:Importi Rimborsare 730-4 Integrativo Type</a>
children	<a href="#">m730:IrpefRimborsare</a> <a href="#">m730:AddRegRimborsare</a> <a href="#">m730:AddComRimborsare</a> <a href="#">m730:CedolareRimborsare</a> <a href="#">m730:TassazioneSepRimborsare</a> <a href="#">m730:PremiRisultatoRimborsare</a>

element **Mod730\_Integrativo\_Type/ImportoRimborsato**

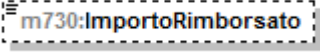
diagram					
namespace	urn:www.agenziaentrate.gov.it:specificheTecniche:sco:730				
type	<a href="#">DatoNP_Type</a>				
facets	<table border="1"> <thead> <tr> <th>Kind</th> <th>Value</th> </tr> </thead> <tbody> <tr> <td>pattern</td> <td>[1-9]{1}[0-9]*</td> </tr> </tbody> </table>	Kind	Value	pattern	[1-9]{1}[0-9]*
Kind	Value				
pattern	[1-9]{1}[0-9]*				

element **Mod730\_Integrativo\_Type/ImportoRimborsatoAgenzia**

diagram	
---------	---

namespace	urn:www.agenziaentrate.gov.it:specificheTecniche:sco:730	
type	<a href="#">DatoNP_Type</a>	
facets	Kind	Value
	pattern	[1-9]{1}[0-9]*

### complexType Modulo\_Altri\_Reddi\_Type

diagram		
namespace	urn:www.agenziaentrate.gov.it:specificheTecniche:sco:730	
children	<a href="#">m730:RedditiDiCapitale</a> <a href="#">m730:RedditiTassazioneSeparata</a>	

### element Modulo\_Altri\_Reddi\_Type/RedditiDiCapitale

diagram		
namespace	urn:www.agenziaentrate.gov.it:specificheTecniche:sco:730	
type	<a href="#">m730:Redditi_Capitale_Type</a>	
children	<a href="#">m730:Utili</a> <a href="#">m730:AltriRedditiDiCapitale</a> <a href="#">m730:LavoroAutonomo</a> <a href="#">m730:RedditiDiversi</a> <a href="#">m730:RedditiDiversiDetraz</a>	

### element Modulo\_Altri\_Reddi\_Type/RedditiTassazioneSeparata

diagram		
namespace	urn:www.agenziaentrate.gov.it:specificheTecniche:sco:730	
type	<a href="#">m730:Redditi Tassazione Separata Type</a>	
children	<a href="#">m730:RedditiErede</a> <a href="#">m730:ImposteRimborsate</a>	

complexType **Modulo\_Annotazioni\_Type**

diagram	
namespace	urn:www.agenziaentrate.gov.it:specificheTecniche:sco:730
children	<a href="#">m730:Annotazione</a>

element **Modulo\_Annotazioni\_Type/Annotazione**

diagram	
namespace	urn:www.agenziaentrate.gov.it:specificheTecniche:sco:730
type	<a href="#">m730:Annotazione_Type</a>
children	<a href="#">m730:Codice</a> <a href="#">m730:RigoQuadro</a> <a href="#">m730:ModuloQuadro</a> <a href="#">m730:Importo</a>

complexType **Modulo\_Comunicazione\_Type**

diagram	
namespace	urn:www.agenziaentrate.gov.it:specificheTecniche:sco:730
children	<a href="#">m730:DatiCondominio</a> <a href="#">m730:DatiCatastali</a> <a href="#">m730:DomandaAccatastamento</a> <a href="#">m730:DatiFornitore</a>

element **Modulo\_Communicazione\_Type/DatiCondominio**

diagram	<p>The diagram shows a class <code>m730:DatiCondominio</code> connected to a container <code>m730:Dati_Condominio_Type</code>. The container contains two elements: <code>m730:CodiceFiscale</code> and <code>m730:Denominazione</code>.</p>
namespace	urn:www.agenziaentrate.gov.it:specificheTecniche:sco:730
type	<a href="#">m730:Dati_Condominio_Type</a>
children	<a href="#">m730:CodiceFiscale</a> <a href="#">m730:Denominazione</a>

element **Modulo\_Communicazione\_Type/DatiCatastali**

diagram	<p>The diagram shows a class <code>m730:DatiCatastali</code> connected to a container <code>m730:Dati_Catastali_Type</code>. The container contains six elements: <code>m730:CodiceComune</code>, <code>m730:TerreniUrbano</code>, <code>m730:SezioneUrbanaComuneCatastale</code>, <code>m730:Foglio</code>, <code>m730:Particella</code>, and <code>m730:Subalterno</code>.</p>
namespace	urn:www.agenziaentrate.gov.it:specificheTecniche:sco:730
type	<a href="#">m730:Dati_Catastali_Type</a>
children	<a href="#">m730:CodiceComune</a> <a href="#">m730:TerreniUrbano</a> <a href="#">m730:SezioneUrbanaComuneCatastale</a> <a href="#">m730:Foglio</a> <a href="#">m730:Particella</a> <a href="#">m730:Subalterno</a>

element **Modulo\_Communicazione\_Type/DomandaAccatastamento**

diagram	<p>The diagram shows a class <code>m730:DomandaAccatastamento</code> connected to a container <code>m730:Domanda_Accatastamento_Type</code>. The container contains three elements: <code>m730:Data</code>, <code>m730:Numero</code>, and <code>m730:ProvinciaUfficio</code>.</p>
namespace	urn:www.agenziaentrate.gov.it:specificheTecniche:sco:730

type	<a href="#">m730:Domanda Accatastamento Type</a>
children	<a href="#">m730:Data</a> <a href="#">m730:Numero</a> <a href="#">m730:ProvinciaUfficio</a>

element **Modulo\_Communicazione\_Type/DatiFornitore**

diagram	
namespace	urn:www.agenziaentrate.gov.it:specificheTecniche:sco:730
type	<a href="#">m730:Dati_Fornitore_Type</a>
children	<a href="#">m730:CodiceFiscale</a> <a href="#">m730:CognomeDenom</a> <a href="#">m730:Nome</a> <a href="#">m730:Sesso</a> <a href="#">m730:DataNascita</a> <a href="#">m730:ComuneNascita</a> <a href="#">m730:ProvinciaNascita</a> <a href="#">m730:ImportoAcquisti</a> <a href="#">m730:StatoEstero</a>

complexType **Modulo\_Crediti\_Imposta\_Type**

diagram	
namespace	urn:www.agenziaentrate.gov.it:specificheTecniche:sco:730
children	<a href="#">m730:CreditoImpostaFondiPensione</a> <a href="#">m730:CreditoImpostaRedditiEsteri</a> <a href="#">m730:CreditoPrimaCasaSismaAbruzzo</a> <a href="#">m730:CreditoAltriSismaAbruzzo</a> <a href="#">m730:CreditoNegoziazione</a>

element **Modulo\_Crediti\_Imposta\_Type/CreditiImpostaFondiPensione**

diagram	
namespace	urn:www.agenziaentrate.gov.it:specificheTecniche:sco:730
type	<a href="#">m730:Crediti Imposta Fondi Pensione Type</a>
children	<a href="#">m730:AnnoAnticipazione</a> <a href="#">m730:Reintegro</a> <a href="#">m730:SommaReintegrata</a> <a href="#">m730:CreditoAnno</a>

element **Modulo\_Crediti\_Imposta\_Type/CreditiImpostaRedditiEsteri**

diagram	
namespace	urn:www.agenziaentrate.gov.it:specificheTecniche:sco:730
type	<a href="#">m730:Crediti Imposta Redditi Esteri Type</a>
children	<a href="#">m730:StatoEsteri</a> <a href="#">m730:Anno</a> <a href="#">m730:RedditoEsteri</a> <a href="#">m730:ImpostaEsteri</a> <a href="#">m730:RedditoComplessivo</a> <a href="#">m730:Imposta_Lorda</a> <a href="#">m730:ImpostaNetta</a> <a href="#">m730:CreditoDichiarazioniPrecedenti</a> <a href="#">m730:DiCuiStatoEsteri</a>

element **Modulo\_Crediti\_Imposta\_Type/CreditoPrimaCasaSismaAbruzzo**

diagram	
namespace	urn:www.agenziaentrate.gov.it:specificheTecniche:sco:730
type	<a href="#">m730:Credito_Immobil..._Type</a>
children	<a href="#">m730:CodiceFiscale</a> <a href="#">m730:NumeroRata</a> <a href="#">m730:TotaleCredito</a>

element **Modulo\_Crediti\_Imposta\_Type/CreditoAltriSismaAbruzzo**

diagram	
namespace	urn:www.agenziaentrate.gov.it:specificheTecniche:sco:730
type	<a href="#">m730:Crediti_Imposta_Altri_Sisma_Abruzzo_Type</a>
children	<a href="#">m730:Impresa_Professione</a> <a href="#">m730:CreditoImmobil...SismaA...</a> <a href="#">m730:Rateazione</a>

element **Modulo\_Crediti\_Imposta\_Type/CreditoNegoziazione**

diagram	
namespace	urn:www.agenziaentrate.gov.it:specificheTecniche:sco:730
type	<a href="#">m730:Modulo_Credito_Negozi..._Type</a>
children	<a href="#">m730:CreditoSpettante</a>

complexType **Modulo\_Credito\_Negozi...\_Type**

diagram	
---------	--



namespace	urn:www.agenziaentrate.gov.it:specificheTecniche:sco:730
children	<a href="#">m730:CreditoSpettante</a>

**element Modulo\_Credito\_Negoziatore\_Type/CreditoSpettante**

diagram					
namespace	urn:www.agenziaentrate.gov.it:specificheTecniche:sco:730				
type	<a href="#">DatoNP_Type</a>				
facets	<table border="1"> <tr> <td>Kind</td> <td>Value</td> </tr> <tr> <td>pattern</td> <td>[1-9]{1}[0-9]*</td> </tr> </table>	Kind	Value	pattern	[1-9]{1}[0-9]*
Kind	Value				
pattern	[1-9]{1}[0-9]*				

**complexType Modulo\_Fabbricato\_Type**

diagram	
namespace	urn:www.agenziaentrate.gov.it:specificheTecniche:sco:730
children	<a href="#">m730:FabbricatoOrd</a> <a href="#">m730:FabbricatoAgev</a>

element **Modulo\_Fabbricato\_Type/FabbricatoOrd**

<p>diagram</p>	
<p>namespace</p>	<p>urn:www.agenziaentrate.gov.it:specificheTecniche:sco:730</p>
<p>type</p>	<p><a href="#">m730:Fabbricato_Ord_Type</a></p>
<p>children</p>	<p><a href="#">m730:Rendita</a> <a href="#">m730:Utilizzo</a> <a href="#">m730:GiorniPossesso</a> <a href="#">m730:PercPossesso</a> <a href="#">m730:CodiceCanone</a> <a href="#">m730:CanoneLocazione</a> <a href="#">m730:CasiParticolari</a> <a href="#">m730:CasellaContinuazione</a> <a href="#">m730:CodiceComune</a> <a href="#">m730:OpzioneCedolare</a> <a href="#">m730:CasellaCasiPartimu</a> <a href="#">m730:StatoEmergenza</a></p>

element **Modulo\_Fabbricato\_Type/FabbricatoAgev**

<p>diagram</p>	
----------------	--

namespace	urn:www.agenziaentrate.gov.it:specificheTecniche:sco:730
type	<a href="#">m730:Fabbricato_Agev_Type</a>
children	<a href="#">m730:NumeroRigoRiferimento</a> <a href="#">m730:NumModuloRiferimento</a> <a href="#">m730:DatiContratto</a> <a href="#">m730:CasellaInf30Giorni</a> <a href="#">m730:AnnoDichiarazioneIcilmu</a>

### complexType **Modulo\_Familiari\_Type**

diagram	
namespace	urn:www.agenziaentrate.gov.it:specificheTecniche:sco:730
children	<a href="#">m730:Coniuge</a> <a href="#">m730:PrimoFiglio</a> <a href="#">m730:Familiari</a>

### element **Modulo\_Familiari\_Type/Coniuge**

diagram	
namespace	urn:www.agenziaentrate.gov.it:specificheTecniche:sco:730
type	<a href="#">m730:Dati_Coniuge_Type</a>
children	<a href="#">m730:Tipo</a> <a href="#">m730:CodiceFiscale</a> <a href="#">m730:Mesi</a>

element **Modulo\_Familiari\_Type/PrimoFiglio**

diagram	<p>The diagram illustrates the structure of the <code>m730:PrimoFiglio</code> element. It is an extension of the <code>m730:Dati_Familiare_Type</code> element. The extension is shown in a yellow dashed box and includes the following elements: <code>m730:CodiceFiscale</code>, <code>m730:Mesi</code>, <code>m730:MesiMinore</code>, <code>m730:PercDetraz</code>, <code>m730:PercDetrazCon</code>, <code>m730:Affidamento</code>, and <code>m730:Tipo</code>. The <code>m730:PrimoFiglio</code> element is shown as a dashed box on the left, connected to the extension box. The <code>m730:Tipo</code> element is shown as a solid box at the bottom, connected to the extension box.</p>
namespace	urn:www.agenziaentrate.gov.it:specificheTecniche:sco:730
type	extension of <a href="#">m730:Dati_Familiare_Type</a>
children	<a href="#">m730:CodiceFiscale</a> <a href="#">m730:Mesi</a> <a href="#">m730:MesiMinore</a> <a href="#">m730:PercDetraz</a> <a href="#">m730:PercDetrazCon</a> <a href="#">m730:Affidamento</a> <a href="#">m730:Tipo</a>

element **Modulo\_Familiari\_Type/PrimoFiglio/Tipo**

diagram	<p>The diagram shows the structure of the <code>m730:Tipo</code> element, which is a restriction of the <code>DatoAN_Type</code> element. The element is shown as a solid box with the text <code>m730:Tipo</code> inside.</p>								
namespace	urn:www.agenziaentrate.gov.it:specificheTecniche:sco:730								
type	restriction of <a href="#">DatoAN_Type</a>								
facets	<table border="0"> <tr> <td>Kind</td> <td>Value</td> </tr> <tr> <td>pattern</td> <td>(([0-9A-Z-])&amp;quot;){1}([ 0-9A-Z&amp;amp;:] ' - \. , /° °\°\( \) À É É Ì Ò Ù Û &amp;quot; \N +)*</td> </tr> <tr> <td>enumeration</td> <td>F</td> </tr> <tr> <td>enumeration</td> <td>D</td> </tr> </table>	Kind	Value	pattern	(([0-9A-Z-])&quot;){1}([ 0-9A-Z&amp;:] ' - \. , /° °\°\( \) À É É Ì Ò Ù Û &quot; \N +)*	enumeration	F	enumeration	D
Kind	Value								
pattern	(([0-9A-Z-])&quot;){1}([ 0-9A-Z&amp;:] ' - \. , /° °\°\( \) À É É Ì Ò Ù Û &quot; \N +)*								
enumeration	F								
enumeration	D								

element **Modulo\_Familiari\_Type/Familiari**

diagram	
namespace	urn:www.agenziaentrate.gov.it:specificheTecniche:sco:730
type	extension of <a href="#">m730:Dati_Familiare_Type</a>
children	<a href="#">m730:CodiceFiscale</a> <a href="#">m730:Mesi</a> <a href="#">m730:MesiMinore</a> <a href="#">m730:PercDetraz</a> <a href="#">m730:PercDetrazCon</a> <a href="#">m730:Affidamento</a> <a href="#">m730:Tipo</a>

element **Modulo\_Familiari\_Type/Familiari/Tipo**

diagram											
namespace	urn:www.agenziaentrate.gov.it:specificheTecniche:sco:730										
type	restriction of <a href="#">DatoAN_Type</a>										
facets	<table border="1"> <thead> <tr> <th>Kind</th> <th>Value</th> </tr> </thead> <tbody> <tr> <td>pattern</td> <td>(([0-9A-Z-])&amp;quot;){1}([ 0-9A-Z&amp;amp;#92; ' \- \., / \^\\( \) À È É Ì Ò Ù Û &amp;quot; \\N \\+)*</td> </tr> <tr> <td>enumeration</td> <td>F</td> </tr> <tr> <td>enumeration</td> <td>D</td> </tr> <tr> <td>enumeration</td> <td>A</td> </tr> </tbody> </table>	Kind	Value	pattern	(([0-9A-Z-])&quot;){1}([ 0-9A-Z&amp;#92; ' \- \., / \^\\( \) À È É Ì Ò Ù Û &quot; \\N \\+)*	enumeration	F	enumeration	D	enumeration	A
Kind	Value										
pattern	(([0-9A-Z-])&quot;){1}([ 0-9A-Z&amp;#92; ' \- \., / \^\\( \) À È É Ì Ò Ù Û &quot; \\N \\+)*										
enumeration	F										
enumeration	D										
enumeration	A										

complexType **Modulo\_Lavoro\_Dip\_Type**

diagram	
---------	--

namespace	urn:www.agenziaentrate.gov.it:specificheTecniche:sco:730
children	<a href="#">m730:LavoroDipendente</a> <a href="#">m730:PremiRisultato</a> <a href="#">m730:AltriRedditiAssLavDip</a> <a href="#">m730:BonusIrpef</a>

element **Modulo\_Lavoro\_Dip\_Type/LavoroDipendente**

diagram	
namespace	urn:www.agenziaentrate.gov.it:specificheTecniche:sco:730
type	<a href="#">m730:Lavoro_Dipendente_Type</a>
children	<a href="#">m730:TipologiaReddito</a> <a href="#">m730:TipoContratto</a> <a href="#">m730:Reddito</a>

element **Modulo\_Lavoro\_Dip\_Type/PremiRisultato**

diagram	
namespace	urn:www.agenziaentrate.gov.it:specificheTecniche:sco:730
type	<a href="#">m730:Premi_Risultato_Modulo_Type</a>
children	<a href="#">m730:TipoLimite</a> <a href="#">m730:ImportoTassazOrdinaria</a> <a href="#">m730:ImportoImpostaSostitutiva</a> <a href="#">m730:RitenuteImpostaSostitutiva</a> <a href="#">m730:Benefit</a> <a href="#">m730:BenefitTassOrdinaria</a>

element **Modulo\_Lavoro\_Dip\_Type/AltriRedditiAssLavDip**

diagram	
namespace	urn:www.agenziaentrate.gov.it:specificheTecniche:sco:730
type	<a href="#">m730:Altri_Redditi_Ass_Lav_Type</a>
children	<a href="#">m730:AssegnoDelConiuge</a> <a href="#">m730:ImportoRedditoAssimilato</a>

element **Modulo\_Lavoro\_Dip\_Type/BonusIrpéf**

diagram	
namespace	urn:www.agenziaentrate.gov.it:specificheTecniche:sco:730
children	<a href="#">m730:Esenzione</a>

element **Modulo\_Lavoro\_Dip\_Type/BonusIrpéf/Esenzione**

diagram	
namespace	urn:www.agenziaentrate.gov.it:specificheTecniche:sco:730
type	<a href="#">m730:Esenzione_Bonus_Type</a>
children	<a href="#">m730:TipologiaEsenzione</a> <a href="#">m730:ParteRedditoEsente</a>

complexType **Modulo\_Oneri\_Type**

<p>diagram</p>	
<p>namespace</p>	<p>urn:www.agenziaentrate.gov.it:specificheTecniche:sco:730</p>
<p>children</p>	<p><a href="#">m730:SpeseDetrazioni</a> <a href="#">m730:SpeseDeduzioni</a> <a href="#">m730:InterventoRecuperoPatrimonioEdilizio</a> <a href="#">m730:DatiCatastaliRecuperoPatrimonioEdilizio</a> <a href="#">m730:InterventoRisparmioEnergetico</a> <a href="#">m730:CanoniLocazione</a> <a href="#">m730:DatiAltreDetrazioni</a> <a href="#">m730:SpeseArredo</a> <a href="#">m730:SpeseArredoGiovani</a> <a href="#">m730:IvaAcquistoAbitazione</a></p>

element **Modulo\_Oneri\_Type/SpeseDetrazioni**

<p>diagram</p>	
<p>namespace</p>	<p>urn:www.agenziaentrate.gov.it:specificheTecniche:sco:730</p>
<p>type</p>	<p><a href="#">m730:Detrazioni Modulo_Type</a></p>



children	<a href="#">m730:VeicoliDisabili</a> <a href="#">m730:AcquistoCaniGuida</a> <a href="#">m730:SpeseRateizzate</a> <a href="#">m730:AltreSpese</a> <a href="#">m730:SpeseLeasing</a>
----------	--

element **Modulo\_Oneri\_Type/SpeseDeduzioni**

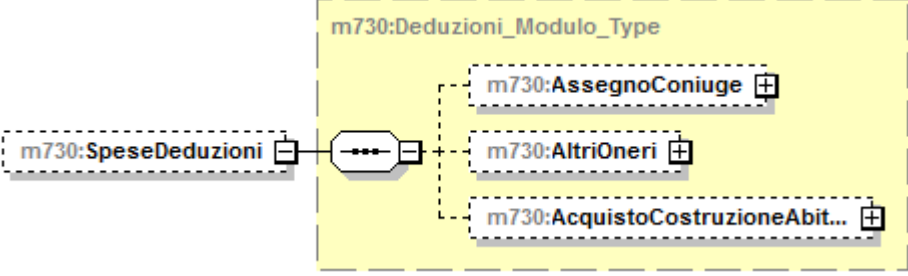
diagram	
namespace	urn:www.agenziaentrate.gov.it:specificheTecniche:sco:730
type	<a href="#">m730:Deduzioni Modulo Type</a>
children	<a href="#">m730:AssegnoConiuge</a> <a href="#">m730:AltriOneri</a> <a href="#">m730:AcquistoCostruzioneAbitLocazione</a>

element **Modulo\_Oneri\_Type/InterventoRecuperoPatrimonioEdilizio**

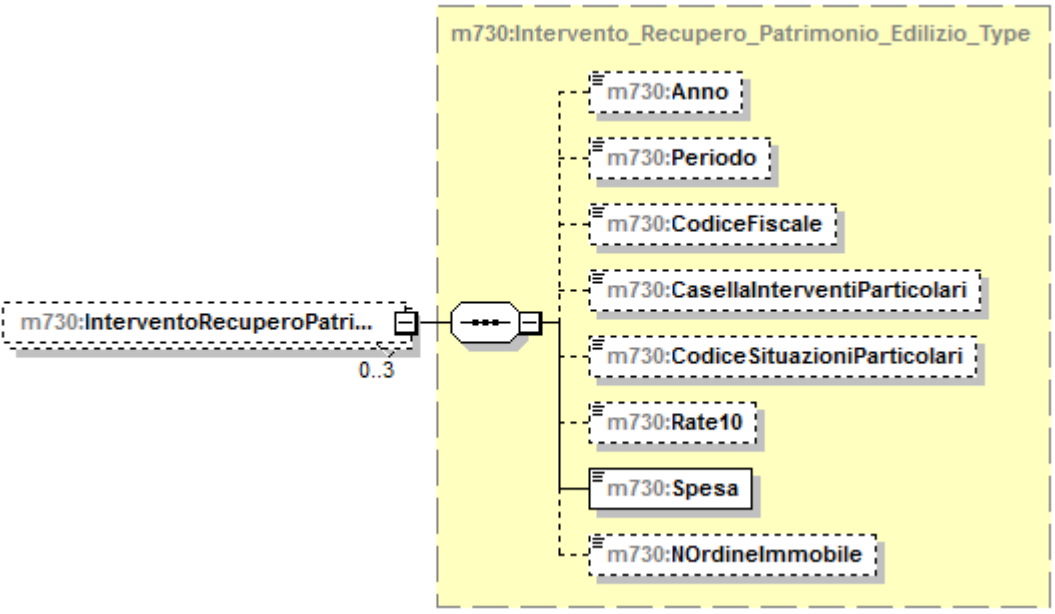
diagram	
namespace	urn:www.agenziaentrate.gov.it:specificheTecniche:sco:730
type	<a href="#">m730:Intervento Ricupero Patrimonio Edilizio Type</a>
children	<a href="#">m730:Anno</a> <a href="#">m730:Periodo</a> <a href="#">m730:CodiceFiscale</a> <a href="#">m730:CasellaInterventiParticolari</a> <a href="#">m730:CodiceSituazioniParticolari</a> <a href="#">m730:Rate10</a> <a href="#">m730:Spesa</a> <a href="#">m730:NOrdineImmobile</a>

element **Modulo\_Oneri\_Type/DatiCatastaliRecuperoPatrimonioEdilizio**

diagram	
namespace	urn:www.agenziaentrate.gov.it:specificheTecniche:sco:730
type	<a href="#">m730:Sezione Dati Catastali Recupero Patrimonio Edilizio Type</a>
children	<a href="#">m730:DatiCatastaliRecuperoPatrimonioEdilizio</a> <a href="#">m730:DatiRegistrazioneAccatastamentoRecuperoPatrimonio Edilizio</a>

element **Modulo\_Oneri\_Type/InterventoRisparmioEnergetico**

diagram	
namespace	urn:www.agenziaentrate.gov.it:specificheTecniche:sco:730
type	<a href="#">m730:Intervento Risparmio Energetico Type</a>
children	<a href="#">m730:TipoIntervento</a> <a href="#">m730:Anno</a> <a href="#">m730:Periodo2013</a> <a href="#">m730:CasiParticolari</a> <a href="#">m730:RideterminazioneRate</a> <a href="#">m730:NumeroRata</a> <a href="#">m730:Spesa</a>

element **Modulo\_Oneri\_Type/CanoniLocazione**

diagram	
---------	--

namespace	urn:www.agenziaentrate.gov.it:specificheTecniche:sco:730
type	<a href="#">m730:Detrazioni Canoni Locazione Type</a>
children	<a href="#">m730:InquiliniAbitazionePrincipale</a> <a href="#">m730:DipendentiTrasferiti</a>

element **Modulo\_Oneri\_Type/DatiAltreDetrazioni**

diagram	
namespace	urn:www.agenziaentrate.gov.it:specificheTecniche:sco:730
type	<a href="#">m730:Dati_Altre_Detrazioni_Modulo_Type</a>
children	<a href="#">m730:AltreDetrazioni</a>

element **Modulo\_Oneri\_Type/SpeseArredo**

diagram	
namespace	urn:www.agenziaentrate.gov.it:specificheTecniche:sco:730
type	<a href="#">m730:Spese_Arredo_Type</a>
children	<a href="#">m730:NumeroRata</a> <a href="#">m730:Importo</a>

element **Modulo\_Oneri\_Type/SpeseArredoGiovani**

diagram	
namespace	urn:www.agenziaentrate.gov.it:specificheTecniche:sco:730
type	<a href="#">m730:Spese_Arredo_Giovani_Coppie_Type</a>
children	<a href="#">m730:Meno35Anni</a> <a href="#">m730:Importo</a>

element **Modulo\_Oneri\_Type/IvaAcquistoAbitazione**

diagram	
namespace	urn:www.agenziaentrate.gov.it:specificheTecniche:sco:730
type	<a href="#">m730:Iva_Acquisto_Abitazione_Type</a>
children	<a href="#">m730:NumeroRata</a> <a href="#">m730:Importo</a>

complexType **Modulo\_PL\_Type**

diagram	
namespace	urn:www.agenziaentrate.gov.it:specificheTecniche:sco:730
children	<a href="#">m730:CredImpEsteri</a>

element **Modulo\_PL\_Type/CredImpEsteri**

diagram	
namespace	urn:www.agenziaentrate.gov.it:specificheTecniche:sco:730
type	<a href="#">m730:Cred_Imp_Esteri_Type</a>
children	<a href="#">m730:Anno</a> <a href="#">m730:TotCredito</a> <a href="#">m730:CreditoStato</a>

complexType **Modulo\_Terreno\_Type**

diagram	
namespace	urn:www.agenziaentrate.gov.it:specificheTecniche:sco:730
children	<a href="#">m730:Terreno</a>

element **Modulo\_Terreno\_Type/Terreno**

<p>diagram</p>	<pre> classDiagram     class m730_Terreno_Type {         m730_RedDominicale         m730_Titolo         m730_RedAgrario         m730_GiorniPossesso         m730_PercPossesso         m730_CanoneVincolistico         m730_CasiParticolari         m730_CasellaContinuazione         m730_CasellaImmuNonDovuta         m730_CasellaColtivatoreDiretto     }     class m730_Terreno {         1..6     }     m730_Terreno_Type "1" -- "1..6" m730_Terreno     </pre>
<p>namespace</p>	<p>urn:www.agenziaentrate.gov.it:specificheTecniche:sco:730</p>
<p>type</p>	<p><a href="#">m730:Terreno_Type</a></p>
<p>children</p>	<p><a href="#">m730:RedDominicale</a> <a href="#">m730:Titolo</a> <a href="#">m730:RedAgrario</a> <a href="#">m730:GiorniPossesso</a> <a href="#">m730:PercPossesso</a>  <a href="#">m730:CanoneVincolistico</a> <a href="#">m730:CasiParticolari</a> <a href="#">m730:CasellaContinuazione</a> <a href="#">m730:CasellaImmuNonDovuta</a>  <a href="#">m730:CasellaColtivatoreDiretto</a></p>

complexType **Oneri\_Non\_Abbattuti\_Type**

diagram	
namespace	urn:www.agenziaentrate.gov.it:specificheTecniche:sco:730
children	<a href="#">m730:DetrazSpeseAssPersonale</a> <a href="#">m730:DetrazErogazBiennaleVenezia</a> <a href="#">m730:DetrazErogazSpettacolo</a> <a href="#">m730:DetrazErogazSettoreMusicale</a> <a href="#">m730:DeduzContributiPaesiSviluppo</a> <a href="#">m730:DeduzOnlus</a> <a href="#">m730:DetrazOspedaleGalliera</a> <a href="#">m730:PrevidenzaCompIDipPubblici</a> <a href="#">m730:InteressiMutuiAgrari</a> <a href="#">m730:DeduzTrust</a>

element **Oneri\_Non\_Abbattuti\_Type/DetrazSpeseAssPersonale**

diagram					
namespace	urn:www.agenziaentrate.gov.it:specificheTecniche:sco:730				
type	<a href="#">DatoNP_Type</a>				
facets	<table border="1"> <thead> <tr> <th>Kind</th> <th>Value</th> </tr> </thead> <tbody> <tr> <td>pattern</td> <td>[1-9]{1}[0-9]*</td> </tr> </tbody> </table>	Kind	Value	pattern	[1-9]{1}[0-9]*
Kind	Value				
pattern	[1-9]{1}[0-9]*				

element **Oneri\_Non\_Abbattuti\_Type/DetrazErogazBiennaleVenezia**

diagram					
namespace	urn:www.agenziaentrate.gov.it:specificheTecniche:sco:730				
type	<a href="#">DatoNP_Type</a>				
facets	<table border="1"> <thead> <tr> <th>Kind</th> <th>Value</th> </tr> </thead> <tbody> <tr> <td>pattern</td> <td>[1-9]{1}[0-9]*</td> </tr> </tbody> </table>	Kind	Value	pattern	[1-9]{1}[0-9]*
Kind	Value				
pattern	[1-9]{1}[0-9]*				

**element Oneri\_Non\_Abbattuti\_Type/DetrazErogazSpettacolo**

diagram	 m730:DetrazErogazSpettacolo
namespace	urn:www.agenziaentrate.gov.it:specificheTecniche:sco:730
type	<a href="#">DatoNP_Type</a>
facets	Kind Value pattern [1-9]{1}[0-9]*

**element Oneri\_Non\_Abbattuti\_Type/DetrazErogazSettoreMusicale**

diagram	 m730:DetrazErogazSettoreMus...
namespace	urn:www.agenziaentrate.gov.it:specificheTecniche:sco:730
type	<a href="#">DatoNP_Type</a>
facets	Kind Value pattern [1-9]{1}[0-9]*

**element Oneri\_Non\_Abbattuti\_Type/DeduzContributiPaesiSviluppo**

diagram	 m730:DeduzContributiPaesiSvilu...
namespace	urn:www.agenziaentrate.gov.it:specificheTecniche:sco:730
type	<a href="#">DatoNP_Type</a>
facets	Kind Value pattern [1-9]{1}[0-9]*

**element Oneri\_Non\_Abbattuti\_Type/DeduzOnlus**

diagram	 m730:DeduzOnlus
namespace	urn:www.agenziaentrate.gov.it:specificheTecniche:sco:730
type	<a href="#">DatoNP_Type</a>
facets	Kind Value pattern [1-9]{1}[0-9]*

**element Oneri\_Non\_Abbattuti\_Type/DetrazOspedaleGalliera**

diagram	 m730:DetrazOspedaleGalliera
namespace	urn:www.agenziaentrate.gov.it:specificheTecniche:sco:730
type	<a href="#">DatoNP_Type</a>
facets	Kind Value pattern [1-9]{1}[0-9]*

element **Oneri\_Non\_Abbattuti\_Type/PrevidenzaCompIDipPubblici**

diagram					
namespace	urn:www.agenziaentrate.gov.it:specificheTecniche:sco:730				
type	<a href="#">DatoNP_Type</a>				
facets	<table border="1"> <tr> <td>Kind</td> <td>Value</td> </tr> <tr> <td>pattern</td> <td>[1-9]{1}[0-9]*</td> </tr> </table>	Kind	Value	pattern	[1-9]{1}[0-9]*
Kind	Value				
pattern	[1-9]{1}[0-9]*				

element **Oneri\_Non\_Abbattuti\_Type/InteressiMutuiAgrari**

diagram					
namespace	urn:www.agenziaentrate.gov.it:specificheTecniche:sco:730				
type	<a href="#">DatoNP_Type</a>				
facets	<table border="1"> <tr> <td>Kind</td> <td>Value</td> </tr> <tr> <td>pattern</td> <td>[1-9]{1}[0-9]*</td> </tr> </table>	Kind	Value	pattern	[1-9]{1}[0-9]*
Kind	Value				
pattern	[1-9]{1}[0-9]*				

element **Oneri\_Non\_Abbattuti\_Type/DeduzTrust**

diagram					
namespace	urn:www.agenziaentrate.gov.it:specificheTecniche:sco:730				
type	<a href="#">DatoNP_Type</a>				
facets	<table border="1"> <tr> <td>Kind</td> <td>Value</td> </tr> <tr> <td>pattern</td> <td>[1-9]{1}[0-9]*</td> </tr> </table>	Kind	Value	pattern	[1-9]{1}[0-9]*
Kind	Value				
pattern	[1-9]{1}[0-9]*				

complexType **Oneri\_Type**

diagram	
namespace	urn:www.agenziaentrate.gov.it:specificheTecniche:sco:730
children	<a href="#">m730:PrimoModulo</a> <a href="#">m730:Modulo</a>



element **Oneri\_Type/PrimoModulo**

<p>diagram</p>	
<p>namespace</p>	<p>urn:www.agenziaentrate.gov.it:specificheTecniche:sco:730</p>
<p>type</p>	<p><a href="#">m730:Primo_Modulo_Oneri_Type</a></p>
<p>children</p>	<p><a href="#">m730:SpeseDetrazioni</a> <a href="#">m730:SpeseDeduzioni</a> <a href="#">m730:InterventoRecuperoPatrimonioEdilizio</a> <a href="#">m730:DatiCatastaliRecuperoPatrimonioEdilizio</a> <a href="#">m730:InterventoRisparmioEnergetico</a> <a href="#">m730:CanoniLocazione</a> <a href="#">m730:DatiAltreDetrazioni</a> <a href="#">m730:OneriNonAbbattuti</a> <a href="#">m730:SpeseArredo</a> <a href="#">m730:SpeseArredoGiovani</a> <a href="#">m730:IvaAcquistoAbitazione</a></p>

element **Oneri\_Type/Modulo**

<p>diagram</p>	
<p>namespace</p>	<p>urn:www.agenziaentrate.gov.it:specificheTecniche:sco:730</p>
<p>type</p>	<p><a href="#">m730:Modulo_Oneri_Type</a></p>
<p>children</p>	<p><a href="#">m730:SpeseDetrazioni</a> <a href="#">m730:SpeseDeduzioni</a> <a href="#">m730:InterventoRecuperoPatrimonioEdilizio</a> <a href="#">m730:DatiCatastaliRecuperoPatrimonioEdilizio</a> <a href="#">m730:InterventoRisparmioEnergetico</a> <a href="#">m730:CanoniLocazione</a> <a href="#">m730:DatiAltreDetrazioni</a> <a href="#">m730:SpeseArredo</a> <a href="#">m730:SpeseArredoGiovani</a> <a href="#">m730:IvaAcquistoAbitazione</a></p>

complexType **Opzione\_Produttivita\_Type**

<p>diagram</p>	
<p>namespace</p>	<p>urn:www.agenziaentrate.gov.it:specificheTecniche:sco:730</p>

complexType **Periodo\_Di\_Lavoro\_Type**

<p>diagram</p>	
<p>namespace</p>	<p>urn:www.agenziaentrate.gov.it:specificheTecniche:sco:730</p>

children	<a href="#">m730:GiorniLavoroDipendente</a> <a href="#">m730:GiorniPensione</a>
----------	---

#### element **Periodo\_Di\_Lavoro\_Type/GiorniLavoroDipendente**

diagram					
namespace	urn:www.agenziaentrate.gov.it:specificheTecniche:sco:730				
type	<a href="#">DatoGA_Type</a>				
facets	<table border="1"> <thead> <tr> <th>Kind</th> <th>Value</th> </tr> </thead> <tbody> <tr> <td>pattern</td> <td>[1-9](((1-9)[0-9]) ((12)[0-9][0-9]) (3[0-5][0-9]) (36[0-5]))</td> </tr> </tbody> </table>	Kind	Value	pattern	[1-9](((1-9)[0-9]) ((12)[0-9][0-9]) (3[0-5][0-9]) (36[0-5]))
Kind	Value				
pattern	[1-9](((1-9)[0-9]) ((12)[0-9][0-9]) (3[0-5][0-9]) (36[0-5]))				

#### element **Periodo\_Di\_Lavoro\_Type/GiorniPensione**

diagram					
namespace	urn:www.agenziaentrate.gov.it:specificheTecniche:sco:730				
type	<a href="#">DatoGA_Type</a>				
facets	<table border="1"> <thead> <tr> <th>Kind</th> <th>Value</th> </tr> </thead> <tbody> <tr> <td>pattern</td> <td>[1-9](((1-9)[0-9]) ((12)[0-9][0-9]) (3[0-5][0-9]) (36[0-5]))</td> </tr> </tbody> </table>	Kind	Value	pattern	[1-9](((1-9)[0-9]) ((12)[0-9][0-9]) (3[0-5][0-9]) (36[0-5]))
Kind	Value				
pattern	[1-9](((1-9)[0-9]) ((12)[0-9][0-9]) (3[0-5][0-9]) (36[0-5]))				

#### complexType **Pignoramento\_Type**

diagram	
namespace	urn:www.agenziaentrate.gov.it:specificheTecniche:sco:730
children	<a href="#">m730:TipoRedditoPignoramento</a> <a href="#">m730:RitenutePignoramento</a>

#### element **Pignoramento\_Type/TipoRedditoPignoramento**

diagram																	
namespace	urn:www.agenziaentrate.gov.it:specificheTecniche:sco:730																
type	restriction of <a href="#">DatoN1_Type</a>																
facets	<table border="1"> <thead> <tr> <th>Kind</th> <th>Value</th> </tr> </thead> <tbody> <tr> <td>pattern</td> <td>[1-9]</td> </tr> <tr> <td>enumeration</td> <td>1</td> </tr> <tr> <td>enumeration</td> <td>2</td> </tr> <tr> <td>enumeration</td> <td>3</td> </tr> <tr> <td>enumeration</td> <td>4</td> </tr> <tr> <td>enumeration</td> <td>5</td> </tr> <tr> <td>enumeration</td> <td>6</td> </tr> </tbody> </table>	Kind	Value	pattern	[1-9]	enumeration	1	enumeration	2	enumeration	3	enumeration	4	enumeration	5	enumeration	6
Kind	Value																
pattern	[1-9]																
enumeration	1																
enumeration	2																
enumeration	3																
enumeration	4																
enumeration	5																
enumeration	6																

element **Pignoramento\_Type/RitenutePignoramento**

diagram	
namespace	urn:www.agenziaentrate.gov.it:specificheTecniche:sco:730
type	<a href="#">DatoNP_Type</a>
facets	Kind Value pattern [1-9]{1}[0-9]*

complexType **Premi\_Risultato\_Modulo\_Type**

diagram	
namespace	urn:www.agenziaentrate.gov.it:specificheTecniche:sco:730
children	<a href="#">m730:TipoLimite</a> <a href="#">m730:ImportoTassazOrdinaria</a> <a href="#">m730:ImportoImpostaSostitutiva</a> <a href="#">m730:RitenuteImpostaSostitutiva</a> <a href="#">m730:Benefit</a> <a href="#">m730:BenefitTassOrdinaria</a>

element **Premi\_Risultato\_Modulo\_Type/TipoLimite**

diagram	
namespace	urn:www.agenziaentrate.gov.it:specificheTecniche:sco:730
type	restriction of <a href="#">DatoN1_Type</a>
facets	Kind Value pattern [1-9] enumeration 1 enumeration 2

element **Premi\_Risultato\_Modulo\_Type/ImportoTassazOrdinaria**

diagram	
namespace	urn:www.agenziaentrate.gov.it:specificheTecniche:sco:730
type	<a href="#">DatoNP_Type</a>
facets	Kind Value pattern [1-9]{1}[0-9]*

**element Premi\_Risultato\_Modulo\_Type/ImportoImpostaSostitutiva**

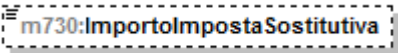
diagram					
namespace	urn:www.agenziaentrate.gov.it:specificheTecniche:sco:730				
type	<a href="#">DatoNP_Type</a>				
facets	<table border="1"> <tr> <td>Kind</td> <td>Value</td> </tr> <tr> <td>pattern</td> <td>[1-9]{1}[0-9]*</td> </tr> </table>	Kind	Value	pattern	[1-9]{1}[0-9]*
Kind	Value				
pattern	[1-9]{1}[0-9]*				

**element Premi\_Risultato\_Modulo\_Type/RitenuteImpostaSostitutiva**

diagram					
namespace	urn:www.agenziaentrate.gov.it:specificheTecniche:sco:730				
type	<a href="#">DatoNP_Type</a>				
facets	<table border="1"> <tr> <td>Kind</td> <td>Value</td> </tr> <tr> <td>pattern</td> <td>[1-9]{1}[0-9]*</td> </tr> </table>	Kind	Value	pattern	[1-9]{1}[0-9]*
Kind	Value				
pattern	[1-9]{1}[0-9]*				

**element Premi\_Risultato\_Modulo\_Type/Benefit**

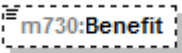
diagram					
namespace	urn:www.agenziaentrate.gov.it:specificheTecniche:sco:730				
type	<a href="#">DatoNP_Type</a>				
facets	<table border="1"> <tr> <td>Kind</td> <td>Value</td> </tr> <tr> <td>pattern</td> <td>[1-9]{1}[0-9]*</td> </tr> </table>	Kind	Value	pattern	[1-9]{1}[0-9]*
Kind	Value				
pattern	[1-9]{1}[0-9]*				

**element Premi\_Risultato\_Modulo\_Type/BenefitTassOrdinaria**

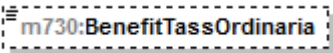
diagram					
namespace	urn:www.agenziaentrate.gov.it:specificheTecniche:sco:730				
type	<a href="#">DatoNP_Type</a>				
facets	<table border="1"> <tr> <td>Kind</td> <td>Value</td> </tr> <tr> <td>pattern</td> <td>[1-9]{1}[0-9]*</td> </tr> </table>	Kind	Value	pattern	[1-9]{1}[0-9]*
Kind	Value				
pattern	[1-9]{1}[0-9]*				

complexType **Premi\_Risultato\_Type**

diagram	
namespace	urn:www.agenziaentrate.gov.it:specificheTecniche:sco:730
type	extension of <a href="#">m730:Premi_Risultato_Modulo_Type</a>
children	<a href="#">m730:TipoLimite</a> <a href="#">m730:ImportoTassazOrdinaria</a> <a href="#">m730:ImportoImpostaSostitutiva</a> <a href="#">m730:RitenuteImpostaSostitutiva</a> <a href="#">m730:Benefit</a> <a href="#">m730:BenefitTassOrdinaria</a> <a href="#">m730:TassazOrdinaria</a> <a href="#">m730:TassazSostitutiva</a> <a href="#">m730:AssenzaRequisiti</a>

element **Premi\_Risultato\_Type/TassazOrdinaria**

diagram	
namespace	urn:www.agenziaentrate.gov.it:specificheTecniche:sco:730
type	<a href="#">DatoCB_Type</a>
facets	Kind Value pattern [01]

element **Premi\_Risultato\_Type/TassazSostitutiva**

diagram	
namespace	urn:www.agenziaentrate.gov.it:specificheTecniche:sco:730
type	<a href="#">DatoCB_Type</a>
facets	Kind Value pattern [01]

element **Premi\_Risultato\_Type/AssenzaRequisiti**

diagram	
namespace	urn:www.agenziaentrate.gov.it:specificheTecniche:sco:730
type	<a href="#">DatoCB_Type</a>
facets	Kind Value pattern [01]

complexType **Primo\_Modulo\_Acconti\_Ritenute\_Type**

diagram	
namespace	urn:www.agenziaentrate.gov.it:specificheTecniche:sco:730
children	<a href="#">m730:Accontilrpef</a> <a href="#">m730:AltreRitenute</a> <a href="#">m730:Eccedenze</a> <a href="#">m730:EccedenzeOltreAnno</a> <a href="#">m730:RitenuteAccontiSospesi</a> <a href="#">m730:MisuraAcconti</a> <a href="#">m730:EsenzioneAddComunale</a> <a href="#">m730:Dati730Integrativo</a> <a href="#">m730:AccontiAltriDati</a> <a href="#">m730:LocazioniBrevi</a>

element **Primo\_Modulo\_Acconti\_Ritenute\_Type/Accontilrpef**

diagram	
namespace	urn:www.agenziaentrate.gov.it:specificheTecniche:sco:730
type	<a href="#">m730:Acconti_Irpef_Anno_Imposta_Type</a>
children	<a href="#">m730:PrimaRataAccontolrpef</a> <a href="#">m730:SecondaRataAccontolrpef</a> <a href="#">m730:AccontoAddComunale</a> <a href="#">m730:PrimaRataAccontoCedolare</a> <a href="#">m730:SecondaRataAccontoCedolare</a>

element **Primo\_Modulo\_Acconti\_Ritenute\_Type/AltreRitenute**

diagram	
namespace	urn:www.agenziaentrate.gov.it:specificheTecniche:sco:730
type	<a href="#">m730:Altre_Ritenute_Type</a>
children	<a href="#">m730:Codice</a> <a href="#">m730:AltreRitenuteIrpef</a> <a href="#">m730:AddizionaleRegionale</a> <a href="#">m730:AddizionaleComunale</a> <a href="#">m730:AddRegionaleIrpefAttivitaSport</a> <a href="#">m730:AddComunaleIrpefAttivitaSport</a> <a href="#">m730:IrpefLavoriSocialmenteUtili</a> <a href="#">m730:AddRegionaleIrpefLavoriSoc Utili</a>



element **Primo\_Modulo\_Acconti\_Ritenute\_Type/Eccedenze**

<p>diagram</p>	<pre> classDiagram     class m730Eccedenze_Type {         m730:Irpef         m730:IrpefCompF24         m730:SostitutivaQuadroRT         m730:SostitutivaQuadroRTcomp...         m730:Cedolare Secca         m730:Cedolare SeccaCompF24         m730:CodiceRegione         m730:AddRegionaleIrpef         m730:AddRegionaleIrpefCompF24         m730:CodiceCatastaleComune         m730:AddComunaleIrpef         m730:AddComunaleIrpefF24         m730:PremioRisultato         m730:PremioRisultatoCompF24     }     class m730Eccedenze {     }     m730Eccedenze_Type -- &gt; m730Eccedenze     </pre>
<p>namespace</p>	<p>urn:www.agenziaentrate.gov.it:specificheTecniche:sco:730</p>
<p>type</p>	<p><a href="#">m730:Eccedenze_Type</a></p>
<p>children</p>	<p><a href="#">m730:Irpef</a> <a href="#">m730:IrpefCompF24</a> <a href="#">m730:SostitutivaQuadroRT</a> <a href="#">m730:SostitutivaQuadroRTcompF24</a>  <a href="#">m730:CedolareSecca</a> <a href="#">m730:CedolareSeccaCompF24</a> <a href="#">m730:CodiceRegione</a> <a href="#">m730:AddRegionaleIrpef</a>  <a href="#">m730:AddRegionaleIrpefCompF24</a> <a href="#">m730:CodiceCatastaleComune</a> <a href="#">m730:AddComunaleIrpef</a>  <a href="#">m730:AddComunaleIrpefF24</a> <a href="#">m730:PremioRisultato</a> <a href="#">m730:PremioRisultatoCompF24</a></p>

element **Primo\_Modulo\_Acconti\_Ritenute\_Type/EccedenzeOltreAnno**

<p>diagram</p>	
<p>namespace</p>	<p>urn:www.agenziaentrate.gov.it:specificheTecniche:sco:730</p>
<p>type</p>	<p><a href="#">m730:Eccedenze Oltre Anno Type</a></p>
<p>children</p>	<p><a href="#">m730:Anno</a> <a href="#">m730:Irpef</a> <a href="#">m730:SostitutivaQuadroRT</a> <a href="#">m730:CedolareSecca</a> <a href="#">m730:CodiceRegione</a> <a href="#">m730:AddRegionaleIrpef</a> <a href="#">m730:CodiceCatastaleComune</a> <a href="#">m730:AddComunaleIrpef</a> <a href="#">m730:ImpostaSostitutiva</a></p>

element **Primo\_Modulo\_Acconti\_Ritenute\_Type/RitenuteAccontiSospesi**

<p>diagram</p>	
<p>namespace</p>	<p>urn:www.agenziaentrate.gov.it:specificheTecniche:sco:730</p>
<p>type</p>	<p><a href="#">m730:Ritenute Acconti Sospesi Type</a></p>
<p>children</p>	<p><a href="#">m730:CodiceEvento</a> <a href="#">m730:Irpef</a> <a href="#">m730:AddRegionaleIrpef</a> <a href="#">m730:AddComunaleIrpef</a> <a href="#">m730:SostitutivaPremi</a> <a href="#">m730:CedolareSecca</a></p>

element **Primo\_Modulo\_Acconti\_Ritenute\_Type/MisuraAcconti**

diagram	
namespace	urn:www.agenziaentrate.gov.it:specificheTecniche:sco:730
type	<a href="#">m730:Misura_Acconti_Type</a>
children	<a href="#">m730:IrpefMisuralInferiore</a> <a href="#">m730:AddComunaleMisuralInferiore</a> <a href="#">m730:CedolareSeccaMisuralInferiore</a> <a href="#">m730:NumeroRate</a>

element **Primo\_Modulo\_Acconti\_Ritenute\_Type/EsenzioneAddComunale**

diagram	
namespace	urn:www.agenziaentrate.gov.it:specificheTecniche:sco:730
type	<a href="#">m730:Esenzione_Add_Comunale_Type</a>
children	<a href="#">m730:SogliaEsenzioneSaldo</a> <a href="#">m730:SogliaEsenzioneAcconto</a>

element **Primo\_Modulo\_Acconti\_Ritenute\_Type/Dati730Integrativo**

diagram	
namespace	urn:www.agenziaentrate.gov.it:specificheTecniche:sco:730
type	<a href="#">m730:Dati_730_Integrativo_Type</a>
children	<a href="#">m730:Rimborso</a> <a href="#">m730:Credito</a>

element **Primo\_Modulo\_Acconti\_Ritenute\_Type/AccontiAltriDati**

diagram	<p>The diagram illustrates the structure of the <code>m730:Acconti_Altri_Dati_Type</code>. It is a complex type (represented by a dashed box) that contains five sub-elements: <code>m730:IncapientiDetrazioneFigli</code>, <code>m730:IncapientiDetrazioneLocaz...</code>, <code>m730:RestituzioneBonusFiscale</code>, <code>m730:RestituzioneBonusStraord...</code>, and <code>m730:Pignoramento</code>. The <code>m730:AccontiAltriDati</code> type is shown as a base type (represented by a dashed box) that inherits from the complex type, indicated by a solid line with an open arrowhead pointing to the complex type.</p>
namespace	urn:www.agenziaentrate.gov.it:specificheTecniche:sco:730
type	<a href="#">m730:Acconti_Altri_Dati_Type</a>
children	<a href="#">m730:IncapientiDetrazioneFigli</a> <a href="#">m730:IncapientiDetrazioneLocazione</a> <a href="#">m730:RestituzioneBonusFiscale</a> <a href="#">m730:RestituzioneBonusStraordinario</a> <a href="#">m730:Pignoramento</a>

element **Primo\_Modulo\_Acconti\_Ritenute\_Type/LocazioniBrevi**

diagram	<p>The diagram illustrates the structure of the <code>m730:Locazioni_Brevi_Type</code>. It is a complex type (represented by a dashed box) that contains one sub-element: <code>m730:Ritenute</code>. The <code>m730:LocazioniBrevi</code> type is shown as a base type (represented by a dashed box) that inherits from the complex type, indicated by a solid line with an open arrowhead pointing to the complex type.</p>
namespace	urn:www.agenziaentrate.gov.it:specificheTecniche:sco:730
type	<a href="#">m730:Locazioni_Brevi_Type</a>
children	<a href="#">m730:Ritenute</a>

complexType **Primo\_Modulo\_Crediti\_Imposta\_Type**

diagram	
namespace	urn:www.agenziaentrate.gov.it:specificheTecniche:sco:730
children	<a href="#">m730:CreditoImpostaFabbricati</a> <a href="#">m730:CreditoImpostaFondiPensione</a> <a href="#">m730:CreditoImpostaRedditiEsteri</a> <a href="#">m730:CreditoPrimaCasaSismaAbruzzo</a> <a href="#">m730:CreditoAltriSismaAbruzzo</a> <a href="#">m730:CreditoIncrementoOccupazione</a> <a href="#">m730:CreditoImpostaMediazioni</a> <a href="#">m730:CreditoErogazioniCultura</a> <a href="#">m730:CreditoNegoziazione</a> <a href="#">m730:CreditoErogazioniScuola</a> <a href="#">m730:CreditoVideosorveglianza</a>

element **Primo\_Modulo\_Crediti\_Imposta\_Type/CreditoImpostaFabbricati**

diagram	
namespace	urn:www.agenziaentrate.gov.it:specificheTecniche:sco:730
type	<a href="#">m730:Crediti_Imposta_Fabbricati_Type</a>
children	<a href="#">m730:ResiduoFabbricati</a> <a href="#">m730:CanoniLocazioneNonPercepti</a>

element **Primo\_Modulo\_Crediti\_Imposta\_Type/CreditImpostaFondiPensione**

diagram	
namespace	urn:www.agenziaentrate.gov.it:specificheTecniche:sco:730
type	extension of <a href="#">m730:Crediti_Imposta_Fondi_Pensione_Type</a>
children	<a href="#">m730:AnnoAnticipazione</a> <a href="#">m730:Reintegro</a> <a href="#">m730:SommaReintegrata</a> <a href="#">m730:CreditoAnno</a> <a href="#">m730:ResiduoPrecedenteDichiarazione</a> <a href="#">m730:DiCuiCompensatoF24</a>

element

**Primo\_Modulo\_Crediti\_Imposta\_Type/CreditImpostaFondiPensione/ResiduoPrecedenteDichiarazione**

diagram					
namespace	urn:www.agenziaentrate.gov.it:specificheTecniche:sco:730				
type	<a href="#">DatoNP_Type</a>				
facets	<table border="1"> <tr> <td>Kind</td> <td>Value</td> </tr> <tr> <td>pattern</td> <td>[1-9]{1}[0-9]*</td> </tr> </table>	Kind	Value	pattern	[1-9]{1}[0-9]*
Kind	Value				
pattern	[1-9]{1}[0-9]*				

element **Primo\_Modulo\_Crediti\_Imposta\_Type/CreditImpostaFondiPensione/DiCuiCompensatoF24**

diagram					
namespace	urn:www.agenziaentrate.gov.it:specificheTecniche:sco:730				
type	<a href="#">DatoNP_Type</a>				
facets	<table border="1"> <tr> <td>Kind</td> <td>Value</td> </tr> <tr> <td>pattern</td> <td>[1-9]{1}[0-9]*</td> </tr> </table>	Kind	Value	pattern	[1-9]{1}[0-9]*
Kind	Value				
pattern	[1-9]{1}[0-9]*				

element **Primo\_Modulo\_Crediti\_Imposta\_Type/CreditiImpostaRedditiEsteri**

diagram	
namespace	urn:www.agenziaentrate.gov.it:specificheTecniche:sco:730
type	<a href="#">m730:Crediti_Imposta_Redditi_Esteri_Type</a>
children	<a href="#">m730:StatoEsteri</a> <a href="#">m730:Anno</a> <a href="#">m730:RedditoEsteri</a> <a href="#">m730:ImpostaEsteri</a> <a href="#">m730:RedditoComplessivo</a> <a href="#">m730:Imposta_Lorda</a> <a href="#">m730:ImpostaNetta</a> <a href="#">m730:CreditoDichiarazioniPrecedenti</a> <a href="#">m730:DiCuiStatoEsteri</a>

element **Primo\_Modulo\_Crediti\_Imposta\_Type/CreditoPrimaCasaSismaAbruzzo**

diagram	
namespace	urn:www.agenziaentrate.gov.it:specificheTecniche:sco:730
type	extension of <a href="#">m730:Credito_Immobile_Sisma_Abruzzo_Type</a>
children	<a href="#">m730:CodiceFiscale</a> <a href="#">m730:NumeroRata</a> <a href="#">m730:TotaleCredito</a> <a href="#">m730:ResiduoPrecedenteDichiarazione</a>

element

**Primo\_Modulo\_Crediti\_Imposta\_Type/CreditoPrimaCasaSismaAbruzzo/ResiduoPrecedenteDichiarazio**

ne

diagram	
namespace	urn:www.agenziaentrate.gov.it:specificheTecniche:sco:730
type	<a href="#">DatoNP_Type</a>
facets	Kind Value pattern [1-9]{1}[0-9]*

element **Primo Modulo Crediti Imposta Type/CreditoAltriSismaAbruzzo**

diagram	
namespace	urn:www.agenziaentrate.gov.it:specificheTecniche:sco:730
type	<a href="#">m730:Crediti_Imposta_Altri_Sisma_Abruzzo_Type</a>
children	<a href="#">m730:Impresa_Professione</a> <a href="#">m730:CreditoImmobileSismaAbruzzo</a> <a href="#">m730:Rateazione</a>

element **Primo Modulo Crediti Imposta Type/CreditoIncrementoOccupazione**

diagram	
namespace	urn:www.agenziaentrate.gov.it:specificheTecniche:sco:730
type	<a href="#">m730:Credito_Incremento_Occupazione_Type</a>
children	<a href="#">m730:ResiduoPrecedenteDichiarazione</a> <a href="#">m730:DiCuiCompensatoF24</a>

element **Primo Modulo Crediti Imposta Type/CreditoImpostaMediazioni**

diagram	
---------	--



namespace	urn:www.agenziaentrate.gov.it:specificheTecniche:sco:730
type	<a href="#">m730:Residuo_Credito_Compens_AnnoImposta_Type</a>
children	<a href="#">m730:CreditoAnno</a> <a href="#">m730:DiCuiCompensatoF24</a>

element **Primo\_Modulo\_Crediti\_Imposta\_Type/CreditoErogazioniCultura**

diagram	
namespace	urn:www.agenziaentrate.gov.it:specificheTecniche:sco:730
type	<a href="#">m730:Credito_Erogazioni_Cultura_Type</a>
children	<a href="#">m730:SpesaAnno</a> <a href="#">m730:ResiduoAnnoPrec</a> <a href="#">m730:RataAnnoPrec</a> <a href="#">m730:RataDueAnniPrec</a>

element **Primo\_Modulo\_Crediti\_Imposta\_Type/CreditoNegoziazione**

diagram	
namespace	urn:www.agenziaentrate.gov.it:specificheTecniche:sco:730
type	<a href="#">m730:Credito_Negoziazione_Type</a>
children	<a href="#">m730:CreditoSpettante</a> <a href="#">m730:ResiduoAnnoPrec</a> <a href="#">m730:DiCuiCompensatoF24</a>

element **Primo\_Modulo\_Crediti\_Imposta\_Type/CreditoErogazioniScuola**

diagram	
namespace	urn:www.agenziaentrate.gov.it:specificheTecniche:sco:730
type	<a href="#">m730:Credito_Erogazioni_Scuola_Type</a>
children	<a href="#">m730:SpesaAnno</a> <a href="#">m730:SpesaAnnoPrec</a> <a href="#">m730:ResiduoAnnoPrec</a>

element **Primo\_Modulo\_Crediti\_Imposta\_Type/CreditoVideosorveglianza**

diagram	
namespace	urn:www.agenziaentrate.gov.it:specificheTecniche:sco:730
type	<a href="#">m730:Credito_Videosorveglianza_Type</a>
children	<a href="#">m730:ResiduoAnnoPrec</a> <a href="#">m730:DiCuiCompensatoF24</a>

complexType **Primo\_Modulo\_Familiari\_Type**

diagram	
namespace	urn:www.agenziaentrate.gov.it:specificheTecniche:sco:730
type	extension of <a href="#">m730:Modulo_Familiari_Type</a>

children	<a href="#">m730:Coniuge</a> <a href="#">m730:PrimoFiglio</a> <a href="#">m730:Familiari</a> <a href="#">m730:PercUlteriore</a> <a href="#">m730:FigliAffidoPread</a>
----------	---

element **Primo\_Modulo\_Familiari\_Type/PercUlteriore**

diagram					
namespace	urn:www.agenziaentrate.gov.it:specificheTecniche:sco:730				
type	<a href="#">DatoPC_Type</a>				
facets	<table border="1"> <tr> <td>Kind</td> <td>Value</td> </tr> <tr> <td>pattern</td> <td>[0-9]?[0-9](, d{1,3})? 100,(0{1,3})?</td> </tr> </table>	Kind	Value	pattern	[0-9]?[0-9](, d{1,3})? 100,(0{1,3})?
Kind	Value				
pattern	[0-9]?[0-9](, d{1,3})? 100,(0{1,3})?				

element **Primo\_Modulo\_Familiari\_Type/FigliAffidoPread**

diagram					
namespace	urn:www.agenziaentrate.gov.it:specificheTecniche:sco:730				
type	<a href="#">DatoNP_Type</a>				
facets	<table border="1"> <tr> <td>Kind</td> <td>Value</td> </tr> <tr> <td>pattern</td> <td>[1-9]{1}[0-9]*</td> </tr> </table>	Kind	Value	pattern	[1-9]{1}[0-9]*
Kind	Value				
pattern	[1-9]{1}[0-9]*				

complexType **Primo\_Modulo\_Lavoro\_Dip\_Type**

diagram	
namespace	urn:www.agenziaentrate.gov.it:specificheTecniche:sco:730
children	<a href="#">m730:LavoroDipendente</a> <a href="#">m730:PremiRisultato</a> <a href="#">m730:PeriodoLavoro</a> <a href="#">m730:AltriRedditiAssLavDip</a> <a href="#">m730:RitenuteLavoroDipendente</a> <a href="#">m730:Bonuslrpef</a> <a href="#">m730:CasellaCasiParticolari</a>

element **Primo Modulo Lavoro Dip Type/LavoroDipendente**

diagram	
namespace	urn:www.agenziaentrate.gov.it:specificheTecniche:sco:730
type	<a href="#">m730:Lavoro_Dipendente_Type</a>
children	<a href="#">m730:TipologiaReddito</a> <a href="#">m730:TipoContratto</a> <a href="#">m730:Reddito</a>

element **Primo Modulo Lavoro Dip Type/PremiRisultato**

diagram	
namespace	urn:www.agenziaentrate.gov.it:specificheTecniche:sco:730
type	<a href="#">m730:Premi_Risultato_Type</a>
children	<a href="#">m730:TipoLimite</a> <a href="#">m730:ImportoTassazOrdinaria</a> <a href="#">m730:ImportoImpostaSostitutiva</a> <a href="#">m730:RitenuteImpostaSostitutiva</a> <a href="#">m730:Benefit</a> <a href="#">m730:BenefitTassOrdinaria</a> <a href="#">m730:TassazOrdinaria</a> <a href="#">m730:TassazSostitutiva</a> <a href="#">m730:AssenzaRequisiti</a>

element **Primo\_Modulo\_Lavoro\_Dip\_Type/PeriodoLavoro**

diagram	<p>The diagram shows a dashed box labeled 'm730:PeriodoLavoro' connected to a solid box labeled 'm730:Periodo_Di_Lavoro_Type'. Inside the solid box, there are two dashed boxes: 'm730:GiorniLavoroDipendente' and 'm730:GiorniPensione'.</p>
namespace	urn:www.agenziaentrate.gov.it:specificheTecniche:sco:730
type	<a href="#">m730:Periodo Di Lavoro Type</a>
children	<a href="#">m730:GiorniLavoroDipendente</a> <a href="#">m730:GiorniPensione</a>

element **Primo\_Modulo\_Lavoro\_Dip\_Type/AltriRedditiAssLavDip**

diagram	<p>The diagram shows a dashed box labeled 'm730:AltriRedditiAssLavDip' connected to a solid box labeled 'm730:Altri_Redditi_Ass_Lav_Type'. The connection has a multiplicity of '0..3'. Inside the solid box, there are two dashed boxes: 'm730:AssegnoDelConiuge' and 'm730:ImportoRedditoAssimilato'.</p>
namespace	urn:www.agenziaentrate.gov.it:specificheTecniche:sco:730
type	<a href="#">m730:Altri Redditi Ass Lav Type</a>
children	<a href="#">m730:AssegnoDelConiuge</a> <a href="#">m730:ImportoRedditoAssimilato</a>

element **Primo\_Modulo\_Lavoro\_Dip\_Type/RitenuteLavoroDipendente**

diagram	<p>The diagram shows a dashed box labeled 'm730:RitenuteLavoroDipendente' connected to a solid box labeled 'm730:Ritenute_Lavoro_Dip_Type'. Inside the solid box, there are five dashed boxes: 'm730:Ritlrpef', 'm730:RitAddRegionale', 'm730:RitAccAddComunale', 'm730:RitSaldoAddComunale', and 'm730:RitAccAddComAnnoPres'.</p>
namespace	urn:www.agenziaentrate.gov.it:specificheTecniche:sco:730
type	<a href="#">m730:Ritenute Lavoro Dip Type</a>
children	<a href="#">m730:Ritlrpef</a> <a href="#">m730:RitAddRegionale</a> <a href="#">m730:RitAccAddComunale</a> <a href="#">m730:RitSaldoAddComunale</a> <a href="#">m730:RitAccAddComAnnoPres</a>

element **Primo\_Modulo\_Lavoro\_Dip\_Type/BonusIrpef**

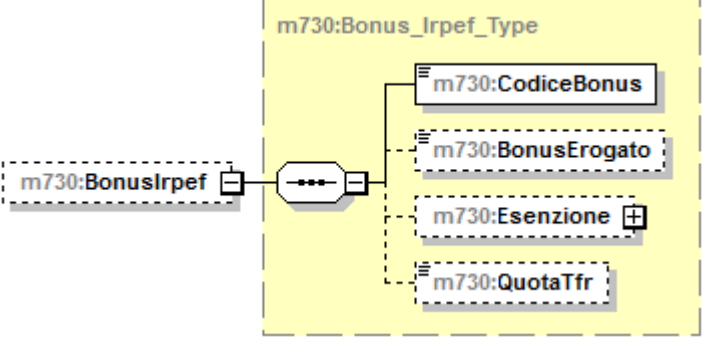
diagram	
namespace	urn:www.agenziaentrate.gov.it:specificheTecniche:sco:730
type	<a href="#">m730:Bonus_Irpef_Type</a>
children	<a href="#">m730:CodiceBonus</a> <a href="#">m730:BonusErogato</a> <a href="#">m730:Esenzione</a> <a href="#">m730:QuotaTfr</a>

element **Primo\_Modulo\_Lavoro\_Dip\_Type/CasellaCasiParticolari**

diagram													
namespace	urn:www.agenziaentrate.gov.it:specificheTecniche:sco:730												
type	restriction of <a href="#">DatoN1_Type</a>												
facets	<table border="1"> <thead> <tr> <th>Kind</th> <th>Value</th> </tr> </thead> <tbody> <tr> <td>pattern</td> <td>[1-9]</td> </tr> <tr> <td>enumeration</td> <td>1</td> </tr> <tr> <td>enumeration</td> <td>2</td> </tr> <tr> <td>enumeration</td> <td>4</td> </tr> <tr> <td>enumeration</td> <td>5</td> </tr> </tbody> </table>	Kind	Value	pattern	[1-9]	enumeration	1	enumeration	2	enumeration	4	enumeration	5
Kind	Value												
pattern	[1-9]												
enumeration	1												
enumeration	2												
enumeration	4												
enumeration	5												

complexType **Primo\_Modulo\_Oneri\_Type**

<p>diagram</p>	
<p>namespace</p>	<p>urn:www.agenziaentrate.gov.it:specificheTecniche:sco:730</p>
<p>children</p>	<p><a href="#">m730:SpeseDetrazioni</a> <a href="#">m730:SpeseDeduzioni</a> <a href="#">m730:InterventoRecuperoPatrimonioEdilizio</a> <a href="#">m730:DatiCatastaliRecuperoPatrimonioEdilizio</a> <a href="#">m730:InterventoRisparmioEnergetico</a> <a href="#">m730:CanoniLocazione</a> <a href="#">m730:DatiAltreDetrazioni</a> <a href="#">m730:OneriNonAbbattuti</a> <a href="#">m730:SpeseArredo</a> <a href="#">m730:SpeseArredoGiovani</a> <a href="#">m730:IvaAcquistoAbitazione</a></p>

element **Primo\_Modulo\_Oneri\_Type/SpeseDetrazioni**

<p>diagram</p>	
<p>namespace</p>	<p>urn:www.agenziaentrate.gov.it:specificheTecniche:sco:730</p>
<p>type</p>	<p><a href="#">m730:Detrazioni_Type</a></p>
<p>children</p>	<p><a href="#">m730:CasellaRateazione</a> <a href="#">m730:SpeseDeterminatePatologie</a> <a href="#">m730:SpeseSanitarie</a> <a href="#">m730:SpeseFamNonACarico</a> <a href="#">m730:SpeseSanitarieDisabili</a> <a href="#">m730:VeicoliDisabili</a> <a href="#">m730:AcquistoCaniGuida</a> <a href="#">m730:SpeseRateizzate</a> <a href="#">m730:MutuiAbPrincipale</a> <a href="#">m730:AltreSpese</a> <a href="#">m730:SpeseLeasing</a></p>



element **Primo\_Modulo\_Oneri\_Type/SpeseDeduzioni**

<p>diagram</p>	
<p>namespace</p>	<p>urn:www.agenziaentrate.gov.it:specificheTecniche:sco:730</p>
<p>type</p>	<p><a href="#">m730:Deduzioni_Type</a></p>
<p>children</p>	<p><a href="#">m730:ContributiPrevAss</a> <a href="#">m730:AssegnoConiuge</a> <a href="#">m730:ContributiColf</a> <a href="#">m730:ErogazionilstituzioniReligiose</a> <a href="#">m730:SpesePortatoriHandicap</a> <a href="#">m730:AltriOneri</a> <a href="#">m730:DeducibilitaOrdinaria</a> <a href="#">m730:LavoratoriPrimaOccupazione</a> <a href="#">m730:FondiInSquilibrioFinanziario</a> <a href="#">m730:FamiliariACarico</a> <a href="#">m730:FondoPensioneDipendentiPubblici</a> <a href="#">m730:AcquistoCostruzioneAbitLocazione</a> <a href="#">m730:RestituzioneSomme</a></p>

element **Primo\_Modulo\_Oneri\_Type/InterventoRecuperoPatrimonioEdilizio**

<p>diagram</p>	
<p>namespace</p>	<p>urn:www.agenziaentrate.gov.it:specificheTecniche:sco:730</p>
<p>type</p>	<p><a href="#">m730:Intervento Recupero Patrimonio Edilizio Type</a></p>
<p>children</p>	<p><a href="#">m730:Anno</a> <a href="#">m730:Periodo</a> <a href="#">m730:CodiceFiscale</a> <a href="#">m730:CasellaInterventiParticolari</a> <a href="#">m730:CodiceSituazioniParticolari</a> <a href="#">m730:Rate10</a> <a href="#">m730:Spesa</a> <a href="#">m730:NOrdineImmobile</a></p>

element **Primo\_Modulo\_Oneri\_Type/DatiCatastaliRecuperoPatrimonioEdilizio**

<p>diagram</p>	
<p>namespace</p>	<p>urn:www.agenziaentrate.gov.it:specificheTecniche:sco:730</p>
<p>type</p>	<p><a href="#">m730:Sezione Dati Catastali Recupero Patrimonio Edilizio Type</a></p>
<p>children</p>	<p><a href="#">m730:DatiCatastaliRecuperoPatrimonioEdilizio</a>  <a href="#">m730:DatiRegistrazioneAccatastamentoRecuperoPatrimonio Edilizio</a></p>

element **Primo\_Modulo\_Oneri\_Type/InterventoRisparmioEnergico**

diagram	
namespace	urn:www.agenziaentrate.gov.it:specificheTecniche:sco:730
type	<a href="#">m730:Intervento_Risparmio_Energetico_Type</a>
children	<a href="#">m730:TipoIntervento</a> <a href="#">m730:Anno</a> <a href="#">m730:Periodo2013</a> <a href="#">m730:CasiParticolari</a> <a href="#">m730:RideterminazioneRate</a> <a href="#">m730:NumeroRata</a> <a href="#">m730:Spesa</a>

element **Primo\_Modulo\_Oneri\_Type/CanoniLocazione**

diagram	
namespace	urn:www.agenziaentrate.gov.it:specificheTecniche:sco:730
type	<a href="#">m730:Detrazioni_Canoni_Locazione_Type</a>
children	<a href="#">m730:InquiliniAbitazionePrincipale</a> <a href="#">m730:DipendentiTrasferiti</a>

element **Primo\_Modulo\_Oneri\_Type/DatiAltreDetrazioni**

diagram	
namespace	urn:www.agenziaentrate.gov.it:specificheTecniche:sco:730
type	<a href="#">m730:Dati_Altre_Detrazioni_Type</a>
children	<a href="#">m730:SpeseCaniGuida</a> <a href="#">m730:AffittoTerreniAgricoliGiov...</a> <a href="#">m730:AltreDetrazioni</a>

namespace	urn:www.agenziaentrate.gov.it:specificheTecniche:sco:730
type	<a href="#">m730:Dati_Altre_Detrazioni_Type</a>
children	<a href="#">m730:SpeseCaniGuida</a> <a href="#">m730:AffittoTerreniAgricoliGiovani</a> <a href="#">m730:AltreDetrazioni</a>

element **Primo\_Modulo\_Oneri\_Type/OneriNonAbbattuti**

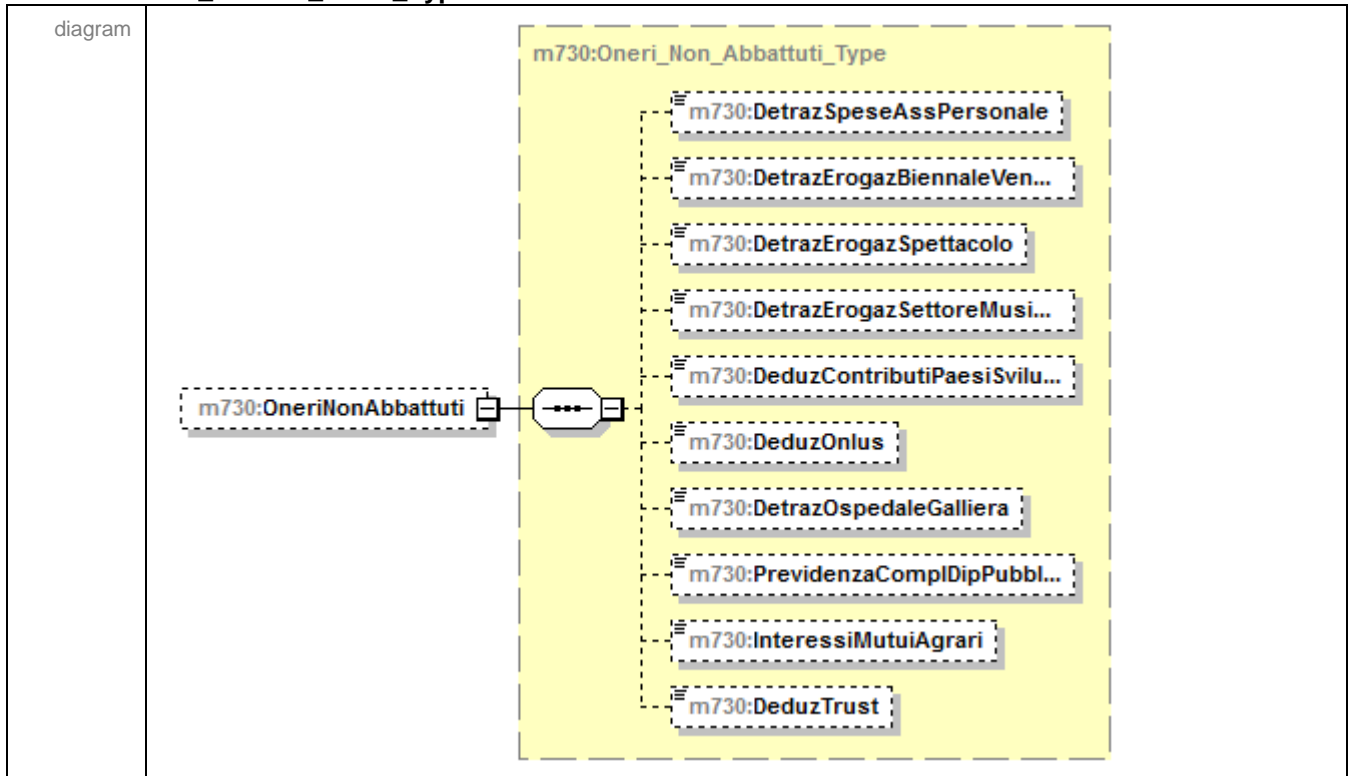

namespace	urn:www.agenziaentrate.gov.it:specificheTecniche:sco:730
type	<a href="#">m730:Oneri_Non_Abbattuti_Type</a>
children	<a href="#">m730:DetrazSpeseAssPersonale</a> <a href="#">m730:DetrazErogazBiennaleVenezia</a> <a href="#">m730:DetrazErogazSpettacolo</a> <a href="#">m730:DetrazErogazSettoreMusicale</a> <a href="#">m730:DeduzContributiPaesiSviluppo</a> <a href="#">m730:DeduzOnlus</a> <a href="#">m730:DetrazOspedaleGalliera</a> <a href="#">m730:PrevidenzaCompIDipPubblici</a> <a href="#">m730:InteressiMutuiAgrari</a> <a href="#">m730:DeduzTrust</a>

element **Primo\_Modulo\_Oneri\_Type/SpeseArredo**

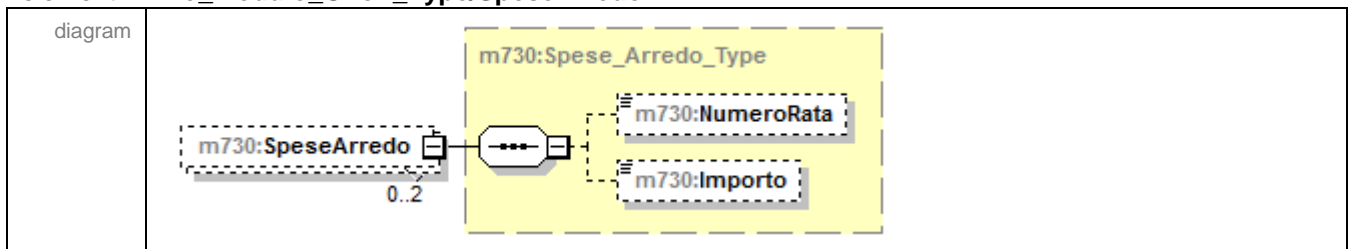

namespace	urn:www.agenziaentrate.gov.it:specificheTecniche:sco:730
type	<a href="#">m730:Spese_Arredo_Type</a>

children	<a href="#">m730:NumeroRata</a> <a href="#">m730:Importo</a>
----------	--

element **Primo\_Modulo\_Oneri\_Type/SpeseArredoGiovani**

diagram	
namespace	urn:www.agenziaentrate.gov.it:specificheTecniche:sco:730
type	<a href="#">m730:Spese_Arredo_Giovani_Coppie_Type</a>
children	<a href="#">m730:Meno35Anni</a> <a href="#">m730:Importo</a>

element **Primo\_Modulo\_Oneri\_Type/IvaAcquistoAbitazione**

diagram	
namespace	urn:www.agenziaentrate.gov.it:specificheTecniche:sco:730
type	<a href="#">m730:Iva_Acquisto_Abitazione_Type</a>
children	<a href="#">m730:NumeroRata</a> <a href="#">m730:Importo</a>

complexType **Primo\_Modulo\_PL\_Type**

diagram	
namespace	urn:www.agenziaentrate.gov.it:specificheTecniche:sco:730
children	<a href="#">m730:Prospetto</a> <a href="#">m730:ProspettoRideterminato</a>

element **Primo\_Modulo\_PL\_Type/Prospetto**

<p>diagram</p>	
<p>namespace</p>	<p>urn:www.agenziaentrate.gov.it:specificheTecniche:sco:730</p>
<p>type</p>	<p>extension of <a href="#">m730:Prospetto_Type</a></p>
<p>children</p>	<p><a href="#">m730:RiepilogoRedditi</a> <a href="#">m730:ImpostaLorda</a> <a href="#">m730:DetrazioniCrediti</a> <a href="#">m730:ImpostaNetta</a> <a href="#">m730:Addizionali</a>  <a href="#">m730:CedolareSecca</a> <a href="#">m730:LiquidazioneImposte</a> <a href="#">m730:AltriDati</a> <a href="#">m730:CredImpEestero</a> <a href="#">m730:DatiCreditiF24</a></p>

element **Primo\_Modulo\_PL\_Type/Prospetto/Addizionali**

<p>diagram</p>	
<p>namespace</p>	<p>urn:www.agenziaentrate.gov.it:specificheTecniche:sco:730</p>
<p>type</p>	<p><a href="#">m730:Addizionali_Type</a></p>
<p>children</p>	<p><a href="#">m730:Imponibile</a> <a href="#">m730:AddRegDovuta</a> <a href="#">m730:AddRegCertif</a> <a href="#">m730:EccedenzaAddReg</a> <a href="#">m730:AddComDovuta</a> <a href="#">m730:AddComCertif</a> <a href="#">m730:EccedenzaAddCom</a> <a href="#">m730:AccontoAddCom</a> <a href="#">m730:AccontoAddComCertif</a></p>

element **Primo\_Modulo\_PL\_Type/Prospetto/CedolareSecca**

<p>diagram</p>	
<p>namespace</p>	<p>urn:www.agenziaentrate.gov.it:specificheTecniche:sco:730</p>
<p>type</p>	<p><a href="#">m730:Cedolare_Secca_Type</a></p>
<p>children</p>	<p><a href="#">m730:CedolareDovuta</a> <a href="#">m730:CedolareDifferenza</a> <a href="#">m730:EccedenzaCedolareSecca</a> <a href="#">m730:AccontoCedolare</a></p>

element **Primo\_Modulo\_PL\_Type/Prospetto/LiquidazioneImposte**

<p>diagram</p>	
<p>namespace</p>	<p>urn:www.agenziaentrate.gov.it:specificheTecniche:sco:730</p>
<p>children</p>	<p><a href="#">m730:EsitoIrpef</a> <a href="#">m730:EsitoAddRegionale</a> <a href="#">m730:EsitoAddComunale</a> <a href="#">m730:PrimaRataAcclrpef</a>  <a href="#">m730:SecondaRataAcclrpef</a> <a href="#">m730:AccontoTassSep</a> <a href="#">m730:AccontoAddComunale</a> <a href="#">m730:ImpostaSostitutiva</a>  <a href="#">m730:EsitoCedolareSecca</a> <a href="#">m730:PrimaRataAccCedolare</a> <a href="#">m730:SecondaRataAccCedolare</a></p>

element **Primo\_Modulo\_PL\_Type/Prospetto/LiquidazioneImposte/EsitoIrpef**

<p>diagram</p>	
<p>namespace</p>	<p>urn:www.agenziaentrate.gov.it:specificheTecniche:sco:730</p>
<p>type</p>	<p><a href="#">m730:Esito_Liquidazione_Type</a></p>
<p>children</p>	<p><a href="#">m730:Credito</a> <a href="#">m730:Debito</a></p>



element **Primo\_Modulo\_PL\_Type/Prospetto/LiquidazioneImposte/EsitoAddRegionale**

diagram	
namespace	urn:www.agenziaentrate.gov.it:specificheTecniche:sco:730
type	extension of <a href="#">m730:Esito_Liquidazione_Type</a>
children	<a href="#">m730:Credito</a> <a href="#">m730:Debito</a> <a href="#">m730:CodAddReg</a>

element **Primo\_Modulo\_PL\_Type/Prospetto/LiquidazioneImposte/EsitoAddRegionale/CodAddReg**

diagram																																															
namespace	urn:www.agenziaentrate.gov.it:specificheTecniche:sco:730																																														
type	<a href="#">Codice Regione Type</a>																																														
facets	<table border="1"> <thead> <tr> <th>Kind</th> <th>Value</th> </tr> </thead> <tbody> <tr> <td>pattern</td> <td>([0-9A-Z-] &amp;quot;){1}([ 0-9A-Z&amp;amp;] ' \- \- . \ ° \^ \( \) À È É ì ò ù Û &amp;quot; \N \+)*</td> </tr> <tr><td>enumeration</td><td>1</td></tr> <tr><td>enumeration</td><td>2</td></tr> <tr><td>enumeration</td><td>3</td></tr> <tr><td>enumeration</td><td>4</td></tr> <tr><td>enumeration</td><td>5</td></tr> <tr><td>enumeration</td><td>6</td></tr> <tr><td>enumeration</td><td>7</td></tr> <tr><td>enumeration</td><td>8</td></tr> <tr><td>enumeration</td><td>9</td></tr> <tr><td>enumeration</td><td>10</td></tr> <tr><td>enumeration</td><td>11</td></tr> <tr><td>enumeration</td><td>12</td></tr> <tr><td>enumeration</td><td>13</td></tr> <tr><td>enumeration</td><td>14</td></tr> <tr><td>enumeration</td><td>15</td></tr> <tr><td>enumeration</td><td>16</td></tr> <tr><td>enumeration</td><td>17</td></tr> <tr><td>enumeration</td><td>18</td></tr> <tr><td>enumeration</td><td>19</td></tr> <tr><td>enumeration</td><td>20</td></tr> <tr><td>enumeration</td><td>21</td></tr> </tbody> </table>	Kind	Value	pattern	([0-9A-Z-] &quot;){1}([ 0-9A-Z&amp;] ' \- \- . \ ° \^ \( \) À È É ì ò ù Û &quot; \N \+)*	enumeration	1	enumeration	2	enumeration	3	enumeration	4	enumeration	5	enumeration	6	enumeration	7	enumeration	8	enumeration	9	enumeration	10	enumeration	11	enumeration	12	enumeration	13	enumeration	14	enumeration	15	enumeration	16	enumeration	17	enumeration	18	enumeration	19	enumeration	20	enumeration	21
Kind	Value																																														
pattern	([0-9A-Z-] &quot;){1}([ 0-9A-Z&amp;] ' \- \- . \ ° \^ \( \) À È É ì ò ù Û &quot; \N \+)*																																														
enumeration	1																																														
enumeration	2																																														
enumeration	3																																														
enumeration	4																																														
enumeration	5																																														
enumeration	6																																														
enumeration	7																																														
enumeration	8																																														
enumeration	9																																														
enumeration	10																																														
enumeration	11																																														
enumeration	12																																														
enumeration	13																																														
enumeration	14																																														
enumeration	15																																														
enumeration	16																																														
enumeration	17																																														
enumeration	18																																														
enumeration	19																																														
enumeration	20																																														
enumeration	21																																														

element **Primo\_Modulo\_PL\_Type/Prospetto/LiquidazioneImposte/EsitoAddComunale**

diagram	
namespace	urn:www.agenziaentrate.gov.it:specificheTecniche:sco:730
type	extension of <a href="#">m730:Esito_Liquidazione_Type</a>
children	<a href="#">m730:Credito</a> <a href="#">m730:Debito</a> <a href="#">m730:CodiceAddCom</a>

element **Primo\_Modulo\_PL\_Type/Prospetto/LiquidazioneImposte/EsitoAddComunale/CodiceAddCom**

diagram					
namespace	urn:www.agenziaentrate.gov.it:specificheTecniche:sco:730				
type	<a href="#">DatoAN_Type</a>				
facets	<table border="1"> <thead> <tr> <th>Kind</th> <th>Value</th> </tr> </thead> <tbody> <tr> <td>pattern</td> <td>([0-9A-Z- &amp;quot;]{1})([ 0-9A-Z&amp;amp;] ' - \. / ° °\°\( \) À É È Ì Ò Ù Ú &amp;quot; \ \\ /+)*</td> </tr> </tbody> </table>	Kind	Value	pattern	([0-9A-Z- &quot;]{1})([ 0-9A-Z&amp;] ' - \. / ° °\°\( \) À É È Ì Ò Ù Ú &quot; \ \\ /+)*
Kind	Value				
pattern	([0-9A-Z- &quot;]{1})([ 0-9A-Z&amp;] ' - \. / ° °\°\( \) À É È Ì Ò Ù Ú &quot; \ \\ /+)*				

element **Primo\_Modulo\_PL\_Type/Prospetto/LiquidazioneImposte/PrimaRataAcclrpef**

diagram					
namespace	urn:www.agenziaentrate.gov.it:specificheTecniche:sco:730				
type	<a href="#">DatoNP_Type</a>				
facets	<table border="1"> <thead> <tr> <th>Kind</th> <th>Value</th> </tr> </thead> <tbody> <tr> <td>pattern</td> <td>[1-9]{1}[0-9]*</td> </tr> </tbody> </table>	Kind	Value	pattern	[1-9]{1}[0-9]*
Kind	Value				
pattern	[1-9]{1}[0-9]*				

element **Primo\_Modulo\_PL\_Type/Prospetto/LiquidazioneImposte/SecondaRataAcclrpef**

diagram					
namespace	urn:www.agenziaentrate.gov.it:specificheTecniche:sco:730				
type	<a href="#">DatoNP_Type</a>				
facets	<table border="1"> <thead> <tr> <th>Kind</th> <th>Value</th> </tr> </thead> <tbody> <tr> <td>pattern</td> <td>[1-9]{1}[0-9]*</td> </tr> </tbody> </table>	Kind	Value	pattern	[1-9]{1}[0-9]*
Kind	Value				
pattern	[1-9]{1}[0-9]*				

element **Primo\_Modulo\_PL\_Type/Prospetto/LiquidazioneImposte/AcontoTassSep**

diagram	
namespace	urn:www.agenziaentrate.gov.it:specificheTecniche:sco:730
type	<a href="#">m730:Debito_Type</a>
children	<a href="#">m730:NonVersare</a> <a href="#">m730:ImportoDaTrattenere</a>

element **Primo\_Modulo\_PL\_Type/Prospetto/LiquidazioneImposte/AcontoAddComunale**

diagram	
namespace	urn:www.agenziaentrate.gov.it:specificheTecniche:sco:730
children	<a href="#">m730:CodiceAddComAcconto</a> <a href="#">m730:AccontoAddCom</a>

element **Primo\_Modulo\_PL\_Type/Prospetto/LiquidazioneImposte/AcontoAddComunale/CodiceAddComAcconto**

diagram					
namespace	urn:www.agenziaentrate.gov.it:specificheTecniche:sco:730				
type	<a href="#">DatoAN_Type</a>				
facets	<table border="1"> <thead> <tr> <th>Kind</th> <th>Value</th> </tr> </thead> <tbody> <tr> <td>pattern</td> <td>(([0-9A-Z-] \&amp;quot;){1}([ 0-9A-Z&amp;amp;:] \- \., / ^ \^\(\ \)\} À É Ì Ò Ù Ú &amp;quot; \ \\ \ +)*</td> </tr> </tbody> </table>	Kind	Value	pattern	(([0-9A-Z-] \&quot;){1}([ 0-9A-Z&amp;:] \- \., / ^ \^\(\ \)\} À É Ì Ò Ù Ú &quot; \ \\ \ +)*
Kind	Value				
pattern	(([0-9A-Z-] \&quot;){1}([ 0-9A-Z&amp;:] \- \., / ^ \^\(\ \)\} À É Ì Ò Ù Ú &quot; \ \\ \ +)*				

element **Primo\_Modulo\_PL\_Type/Prospetto/LiquidazioneImposte/AcontoAddComunale/AcontoAddCom**

diagram					
namespace	urn:www.agenziaentrate.gov.it:specificheTecniche:sco:730				
type	<a href="#">DatoNP_Type</a>				
facets	<table border="1"> <thead> <tr> <th>Kind</th> <th>Value</th> </tr> </thead> <tbody> <tr> <td>pattern</td> <td>[1-9]{1}[0-9]*</td> </tr> </tbody> </table>	Kind	Value	pattern	[1-9]{1}[0-9]*
Kind	Value				
pattern	[1-9]{1}[0-9]*				

element **Primo\_Modulo\_PL\_Type/Prospetto/LiquidazioneImposte/ImpostaSostitutiva**

diagram	
namespace	urn:www.agenziaentrate.gov.it:specificheTecniche:sco:730
type	<a href="#">m730:Debito_Type</a>
children	<a href="#">m730:NonVersare</a> <a href="#">m730:ImportoDaTrattenere</a>

element **Primo\_Modulo\_PL\_Type/Prospetto/LiquidazioneImposte/EsitoCedolareSecca**

diagram	
namespace	urn:www.agenziaentrate.gov.it:specificheTecniche:sco:730
type	<a href="#">m730:Esito_Liquidazione_Type</a>
children	<a href="#">m730:Credito</a> <a href="#">m730:Debito</a>

element **Primo\_Modulo\_PL\_Type/Prospetto/LiquidazioneImposte/PrimaRataAccCedolare**

diagram					
namespace	urn:www.agenziaentrate.gov.it:specificheTecniche:sco:730				
type	<a href="#">DatoNP_Type</a>				
facets	<table border="1"> <thead> <tr> <th>Kind</th> <th>Value</th> </tr> </thead> <tbody> <tr> <td>pattern</td> <td>[1-9]{1}[0-9]*</td> </tr> </tbody> </table>	Kind	Value	pattern	[1-9]{1}[0-9]*
Kind	Value				
pattern	[1-9]{1}[0-9]*				

element **Primo\_Modulo\_PL\_Type/Prospetto/LiquidazioneImposte/SecondaRataAccCedolare**

diagram					
namespace	urn:www.agenziaentrate.gov.it:specificheTecniche:sco:730				
type	<a href="#">DatoNP_Type</a>				
facets	<table border="1"> <thead> <tr> <th>Kind</th> <th>Value</th> </tr> </thead> <tbody> <tr> <td>pattern</td> <td>[1-9]{1}[0-9]*</td> </tr> </tbody> </table>	Kind	Value	pattern	[1-9]{1}[0-9]*
Kind	Value				
pattern	[1-9]{1}[0-9]*				

element **Primo\_Modulo\_PL\_Type/Prospetto/AltriDati**

<p>diagram</p>	
<p>namespace</p>	<p>urn:www.agenziaentrate.gov.it:specificheTecniche:sco:730</p>
<p>type</p>	<p><a href="#">m730:Altri_Dati_Type</a></p>
<p>children</p>	<p> <a href="#">m730:ResiduoCreditoErogazioneCultura</a> <a href="#">m730:ResiduoCreditoPrimaCasa</a> <a href="#">m730:ResiduoCreditoOccupazione</a> <a href="#">m730:ResiduoCreditoSisma</a> <a href="#">m730:ResiduoCreditoFondiPensione</a> <a href="#">m730:ResiduoCreditoMediazioni</a> <a href="#">m730:TotSpeseSanitarieRateizzate</a> <a href="#">m730:RedditoAgevolazioniFiscali</a> <a href="#">m730:RedditoComplessivoAcconto</a> <a href="#">m730:RigoDifferenzaAcconto</a> <a href="#">m730:AccontiCompensatiIntern</a> <a href="#">m730:RedditiFondiariniNonImponibili</a> <a href="#">m730:RedditoAbitazionePrincipalePertinenze</a> <a href="#">m730:ResiduoDeduzioneSommeRestituite</a> <a href="#">m730:ResiduoErogazioniScuola</a> <a href="#">m730:ResiduoCreditoNegoziazione</a> <a href="#">m730:ResiduoCreditoVideosorveglianza</a> <a href="#">m730:CreditoErogazioneCultura</a> </p>

element **Primo\_Modulo\_PL\_Type/Prospetto/CredImpEstero**

<p>diagram</p>	<p>The diagram illustrates the structure of the <code>m730:CredImpEstero</code> element. It is a complex type (indicated by a dashed box) that contains three child elements: <code>m730:Anno</code>, <code>m730:TotCredito</code>, and <code>m730:CreditoStato</code>. The <code>m730:CreditoStato</code> element has a cardinality of <code>1..2</code>, indicating it can occur once or twice. The entire structure is contained within a yellow-shaded box labeled <code>m730:Cred_Imp_Estero_Type</code>.</p>
<p>namespace</p>	<p>urn:www.agenziaentrate.gov.it:specificheTecniche:sco:730</p>
<p>type</p>	<p><a href="#">m730:Cred_Imp_Estero_Type</a></p>
<p>children</p>	<p><a href="#">m730:Anno</a> <a href="#">m730:TotCredito</a> <a href="#">m730:CreditoStato</a></p>

element **Primo\_Modulo\_PL\_Type/Prospetto/DatiCreditiF24**

<p>diagram</p>	
<p>namespace</p>	<p>urn:www.agenziaentrate.gov.it:specificheTecniche:sco:730</p>
<p>type</p>	<p><a href="#">m730:Crediti_F24_Type</a></p>
<p>children</p>	<p><a href="#">m730:Credlrpef</a> <a href="#">m730:CredlrpefDipNoSostituto</a> <a href="#">m730:CodAddReg</a> <a href="#">m730:CredAddReg</a>  <a href="#">m730:CredAddRegDipNoSostituto</a> <a href="#">m730:CodiceAddCom</a> <a href="#">m730:CredAddCom</a> <a href="#">m730:CredAddComDipNoSostituto</a>  <a href="#">m730:CredCedolare</a> <a href="#">m730:CredCedolareDipNoSostituto</a> <a href="#">m730:CredTassSeparDipNoSostituto</a>  <a href="#">m730:CredImpostaSostDipNoSostituto</a> <a href="#">m730:Totale</a> <a href="#">m730:TotaleDipNoSostituto</a></p>

element **Primo\_Modulo\_PL\_Type/ProspettoRideterminato**

diagram	
namespace	urn:www.agenziaentrate.gov.it:specificheTecniche:sco:730
type	extension of <a href="#">m730:Prospetto_Type</a>
children	<a href="#">m730:RiepilogoRedditi</a> <a href="#">m730:ImpostaLorda</a> <a href="#">m730:DetrazioniCrediti</a> <a href="#">m730:ImpostaNetta</a> <a href="#">m730:RedditoAgevolazioniFiscali</a>

element **Primo\_Modulo\_PL\_Type/ProspettoRideterminato/RedditoAgevolazioniFiscali**

diagram					
namespace	urn:www.agenziaentrate.gov.it:specificheTecniche:sco:730				
type	<a href="#">DatoNP_Type</a>				
facets	<table border="1"> <thead> <tr> <th>Kind</th> <th>Value</th> </tr> </thead> <tbody> <tr> <td>pattern</td> <td>[1-9]{1}[0-9]*</td> </tr> </tbody> </table>	Kind	Value	pattern	[1-9]{1}[0-9]*
Kind	Value				
pattern	[1-9]{1}[0-9]*				

complexType **Prospetto\_Annotazioni\_Type**

diagram	
namespace	urn:www.agenziaentrate.gov.it:specificheTecniche:sco:730
children	<a href="#">m730:Modulo_Annotazioni</a>

element **Prospetto\_Annotazioni\_Type/Modulo\_Annotazioni**

diagram	
namespace	urn:www.agenziaentrate.gov.it:specificheTecniche:sco:730



type	<a href="#">m730:Modulo Annotazioni Type</a>
children	<a href="#">m730:Annotazione</a>

### complexType [Prospetto\\_Liquidazione\\_Type](#)

diagram	
namespace	urn:www.agenziaentrate.gov.it:specificheTecniche:sco:730
children	<a href="#">m730:PrimoModulo</a> <a href="#">m730:Modulo</a>

### element [Prospetto\\_Liquidazione\\_Type/PrimoModulo](#)

diagram	
namespace	urn:www.agenziaentrate.gov.it:specificheTecniche:sco:730
type	<a href="#">m730:Primo Modulo PL Type</a>
children	<a href="#">m730:Prospetto</a> <a href="#">m730:ProspettoRideterminato</a>

### element [Prospetto\\_Liquidazione\\_Type/Modulo](#)

diagram	
namespace	urn:www.agenziaentrate.gov.it:specificheTecniche:sco:730
type	<a href="#">m730:Modulo PL Type</a>
children	<a href="#">m730:CredImpEstero</a>

complexType **Prospetto\_Type**

diagram	
namespace	urn:www.agenziaentrate.gov.it:specificheTecniche:sco:730
children	<a href="#">m730:RiepilogoRedditi</a> <a href="#">m730:ImpostaLorda</a> <a href="#">m730:DetrazioniCrediti</a> <a href="#">m730:ImpostaNetta</a>

element **Prospetto\_Type/RiepilogoRedditi**

diagram	
namespace	urn:www.agenziaentrate.gov.it:specificheTecniche:sco:730
type	<a href="#">m730:Riepilogo_Redditi_Type</a>
children	<a href="#">m730:Dominicali</a> <a href="#">m730:Agrari</a> <a href="#">m730:Fabbricati</a> <a href="#">m730:LavDip</a> <a href="#">m730:AltriRedditi</a> <a href="#">m730:ImponibileCedolare</a> <a href="#">m730:ImponibileCedolareOrdinario</a> <a href="#">m730:ImponibileCedolareAgevolato</a> <a href="#">m730:AbitazionePrincipalePertinenze</a>

element **Prospetto\_Type/ImpostaLorda**

<p>diagram</p>	<pre> classDiagram     class m730:ImpostaLorda     class m730:Imposta_Lorda_Type     class m730:RedditoComplessivo     class m730:DeduzioneAbitazPrincipale     class m730:OneriDeducibili     class m730:RedditoImponibile     class m730:CompensiAttSport     class m730:ImportoImpostaLorda      m730:ImpostaLorda "1" *-- "1" m730:Imposta_Lorda_Type     m730:Imposta_Lorda_Type "1" *-- "1" m730:RedditoComplessivo     m730:Imposta_Lorda_Type "1" *-- "1" m730:DeduzioneAbitazPrincipale     m730:Imposta_Lorda_Type "1" *-- "1" m730:OneriDeducibili     m730:Imposta_Lorda_Type "1" *-- "1" m730:RedditoImponibile     m730:Imposta_Lorda_Type "1" *-- "1" m730:CompensiAttSport     m730:Imposta_Lorda_Type "1" *-- "1" m730:ImportoImpostaLorda     </pre>
<p>namespace</p>	<p>urn:www.agenziaentrate.gov.it:specificheTecniche:sco:730</p>
<p>type</p>	<p><a href="#">m730:Imposta_Lorda_Type</a></p>
<p>children</p>	<p><a href="#">m730:RedditoComplessivo</a> <a href="#">m730:DeduzioneAbitazPrincipale</a> <a href="#">m730:OneriDeducibili</a> <a href="#">m730:RedditoImponibile</a> <a href="#">m730:CompensiAttSport</a> <a href="#">m730:ImportoImpostaLorda</a></p>

element **Prospetto\_Type/DetrazioniCrediti**

<p>diagram</p>	
<p>namespace</p>	<p>urn:www.agenziaentrate.gov.it:specificheTecniche:sco:730</p>
<p>type</p>	<p><a href="#">m730:Detrazione_Crediti_Type</a></p>
<p>children</p>	<p><a href="#">m730:DetrazioneConiuge</a> <a href="#">m730:DetrazioneFigli</a> <a href="#">m730:UlterioreDetrazioneFigli</a> <a href="#">m730:DetrazioneFamiliari</a> <a href="#">m730:DetrazioneLavDip</a> <a href="#">m730:DetrazionePens</a> <a href="#">m730:DetrazioneAltriRedditi</a> <a href="#">m730:DetrazioneOneri</a></p>

[m730:DetrazioneRistrutturazione](#) [m730:DetrazioniArredolImmobili](#) [m730:DetrazioneRisparmioEnergetico](#)  
[m730:DetrazioneArredoGiovaniCoppie](#) [m730:DetrazionelvaAcquistoAbitaz](#) [m730:DetrazioneLocEAgricoliGiovani](#)  
[m730:AltreDetrazioni](#) [m730:CreditoPrimaCasa](#) [m730:CreditoOccupazione](#) [m730:CreditoFondiPensione](#)  
[m730:CreditoMediazioni](#) [m730:CreditoNegoziazione](#) [m730:TotaleDetrazioniCrediti](#)

element **Prospetto\_Type/ImpostaNetta**

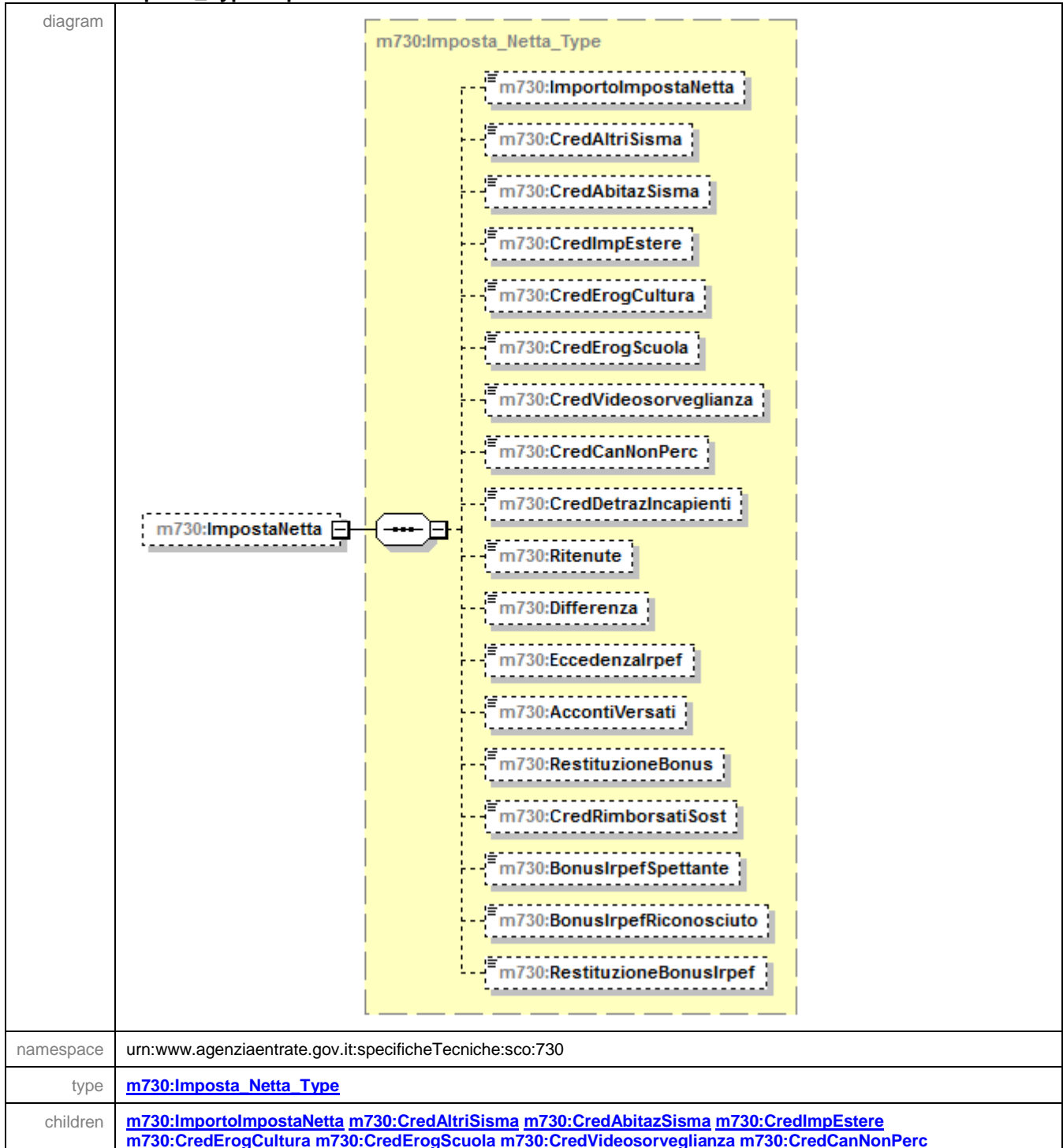

	<a href="#">m730:CredDetrazIncapienti</a> <a href="#">m730:Ritenute</a> <a href="#">m730:Differenza</a> <a href="#">m730:EccedenzaIrpef</a> <a href="#">m730:AccontiVersati</a> <a href="#">m730:RestituzioneBonus</a> <a href="#">m730:CredRimborsatiSost</a> <a href="#">m730:BonusIrpefSpettante</a> <a href="#">m730:BonusIrpefRiconosciuto</a> <a href="#">m730:RestituzioneBonusIrpef</a>
--	---

### complexType Quadro\_I\_Type

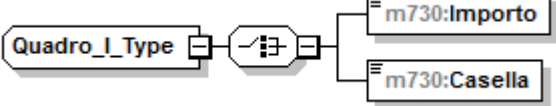
diagram	
namespace	urn:www.agenziaentrate.gov.it:specificheTecniche:sco:730
children	<a href="#">m730:Importo</a> <a href="#">m730:Casella</a>

### element Quadro\_I\_Type/Importo

diagram					
namespace	urn:www.agenziaentrate.gov.it:specificheTecniche:sco:730				
type	<a href="#">DatoNP_Type</a>				
facets	<table border="1"> <thead> <tr> <th>Kind</th> <th>Value</th> </tr> </thead> <tbody> <tr> <td>pattern</td> <td>[1-9]{1}[0-9]*</td> </tr> </tbody> </table>	Kind	Value	pattern	[1-9]{1}[0-9]*
Kind	Value				
pattern	[1-9]{1}[0-9]*				

### element Quadro\_I\_Type/Casella

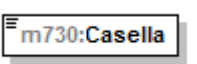
diagram					
namespace	urn:www.agenziaentrate.gov.it:specificheTecniche:sco:730				
type	<a href="#">DatoCB_Type</a>				
facets	<table border="1"> <thead> <tr> <th>Kind</th> <th>Value</th> </tr> </thead> <tbody> <tr> <td>pattern</td> <td>[01]</td> </tr> </tbody> </table>	Kind	Value	pattern	[01]
Kind	Value				
pattern	[01]				

### complexType Quadro\_K\_Type

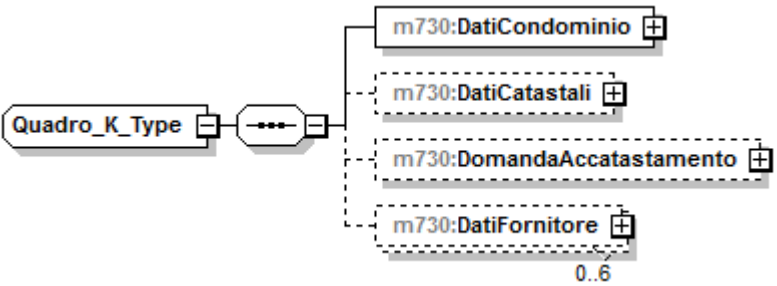
diagram	
namespace	urn:www.agenziaentrate.gov.it:specificheTecniche:sco:730
children	<a href="#">m730:DatiCondominio</a> <a href="#">m730:DatiCatastali</a> <a href="#">m730:DomandaAccatastamento</a> <a href="#">m730:DatiFornitore</a>

element **Quadro\_K\_Type/DatiCondominio**

diagram	
namespace	urn:www.agenziaentrate.gov.it:specificheTecniche:sco:730
type	<a href="#">m730:Dati_Condominio_Type</a>
children	<a href="#">m730:CodiceFiscale</a> <a href="#">m730:Denominazione</a>

element **Quadro\_K\_Type/DatiCatastali**

diagram	
namespace	urn:www.agenziaentrate.gov.it:specificheTecniche:sco:730
type	<a href="#">m730:Dati_Catastali_Type</a>
children	<a href="#">m730:CodiceComune</a> <a href="#">m730:TerreniUrbano</a> <a href="#">m730:SezioneUrbanaComuneCatastale</a> <a href="#">m730:Foglio</a> <a href="#">m730:Particella</a> <a href="#">m730:Subalterno</a>

element **Quadro\_K\_Type/DomandaAccatastamento**

diagram	
namespace	urn:www.agenziaentrate.gov.it:specificheTecniche:sco:730
type	<a href="#">m730:Domanda_Accatastamento_Type</a>
children	<a href="#">m730:Data</a> <a href="#">m730:Numero</a> <a href="#">m730:ProvinciaUfficio</a>

namespace	urn:www.agenziaentrate.gov.it:specificheTecniche:sco:730
type	<a href="#">m730:Domanda Accatastamento Type</a>
children	<a href="#">m730:Data</a> <a href="#">m730:Numero</a> <a href="#">m730:ProvinciaUfficio</a>

element **Quadro\_K\_Type/DatiFornitore**

diagram	
namespace	urn:www.agenziaentrate.gov.it:specificheTecniche:sco:730
type	<a href="#">m730:Dati Fornitore Type</a>
children	<a href="#">m730:CodiceFiscale</a> <a href="#">m730:CognomeDenom</a> <a href="#">m730:Nome</a> <a href="#">m730:Sesso</a> <a href="#">m730:DataNascita</a> <a href="#">m730:ComuneNascita</a> <a href="#">m730:ProvinciaNascita</a> <a href="#">m730:ImportoAcquisti</a> <a href="#">m730:StatoEstero</a>

complexType **Rappresentante\_Type**

diagram	
namespace	urn:www.agenziaentrate.gov.it:specificheTecniche:sco:730
children	<a href="#">m730:SoggettoFiscale</a> <a href="#">m730:DatiAnagrafici</a> <a href="#">m730:ResidenzaAnagrafica</a> <a href="#">m730:Firma</a>



element **Rappresentante\_Type/SoggettoFiscale**

diagram	
namespace	urn:www.agenziaentrate.gov.it:specificheTecniche:sco:730
type	<a href="#">m730:Soggetto_Fiscale_730_Type</a>
children	<a href="#">m730:CodiceFiscale</a> <a href="#">m730:Email</a> <a href="#">m730:Telefono</a> <a href="#">m730:Cellulare</a>

element **Rappresentante\_Type/DatiAnagrafici**

diagram	
namespace	urn:www.agenziaentrate.gov.it:specificheTecniche:sco:730
type	<a href="#">Dati_Anagrafici_Type</a>
children	<a href="#">Cognome</a> <a href="#">Nome</a> <a href="#">Sesso</a> <a href="#">DataNascita</a> <a href="#">ComuneNascita</a> <a href="#">ProvinciaNascita</a>

element **Rappresentante\_Type/ResidenzaAnagrafica**

diagram	
namespace	urn:www.agenziaentrate.gov.it:specificheTecniche:sco:730
type	<a href="#">m730:Residenza_Rappresentante_Type</a>
children	<a href="#">Comune</a> <a href="#">Provincia</a> <a href="#">CodiceComune</a> <a href="#">Indirizzo</a> <a href="#">Cap</a> <a href="#">m730:Tipologia</a> <a href="#">m730:NumCivico</a> <a href="#">m730:Frazione</a>

element **Rappresentante\_Type/Firma**

diagram	
namespace	urn:www.agenziaentrate.gov.it:specificheTecniche:sco:730
type	<a href="#">DatoCB_Type</a>
facets	Kind Value pattern [01]

complexType **Redditi\_Capitale\_Type**

diagram	
namespace	urn:www.agenziaentrate.gov.it:specificheTecniche:sco:730

children	<a href="#">m730:Utili</a> <a href="#">m730:AltriRedditiDiCapitale</a> <a href="#">m730:LavoroAutonomo</a> <a href="#">m730:RedditiDiversi</a> <a href="#">m730:RedditiDiversiDetraz</a>
----------	--

element **Redditi\_Capitale\_Type/Utili**

diagram	
namespace	urn:www.agenziaentrate.gov.it:specificheTecniche:sco:730
type	<a href="#">m730:Altri_Redditi_Utili_Type</a>
children	<a href="#">m730:Tipo_Reddito</a> <a href="#">m730:RedditiRitenute</a>

element **Redditi\_Capitale\_Type/AltriRedditiDiCapitale**

diagram	
namespace	urn:www.agenziaentrate.gov.it:specificheTecniche:sco:730
type	<a href="#">m730:Sezione_Altri_Redd_Type</a>
children	<a href="#">m730:TipoReddito</a> <a href="#">m730:RedditiRitenute</a>

element **Redditi\_Capitale\_Type/LavoroAutonomo**

diagram	
namespace	urn:www.agenziaentrate.gov.it:specificheTecniche:sco:730
type	<a href="#">m730:Altri_Redditi_Lavoro_Autonomo_Type</a>
children	<a href="#">m730:TipoReddito</a> <a href="#">m730:RedditiRitenute</a>

element **Redditi\_Capitale\_Type/RedditiDiversi**

diagram	
namespace	urn:www.agenziaentrate.gov.it:specificheTecniche:sco:730
type	<a href="#">m730:Altri_Redditi_Diversi_Type</a>
children	<a href="#">m730:CedolareSecca</a> <a href="#">m730:TipoReddito</a> <a href="#">m730:RedditiRitenuteSpese</a>

element **Redditi\_Capitale\_Type/RedditiDiversiDetraz**

diagram	
namespace	urn:www.agenziaentrate.gov.it:specificheTecniche:sco:730
type	<a href="#">m730:Altri_Redditi_Diversi_Detr_Type</a>
children	<a href="#">m730:Tipo_Reddito</a> <a href="#">m730:RedditiRitenuteSpese</a>

complexType **Redditi\_Eredi\_Legatari\_Type**

diagram	
namespace	urn:www.agenziaentrate.gov.it:specificheTecniche:sco:730

type	extension of <a href="#">m730:Tassazione Separata Type</a>
children	<a href="#">m730:Opzione</a> <a href="#">m730:Anno</a> <a href="#">m730:RedditoRitenute</a> <a href="#">m730:TipoReddito</a> <a href="#">m730:RedditoTotale</a> <a href="#">m730:QuotalmposteSuccessioni</a>

#### element **Redditi\_Eredi\_Legatari\_Type/TipoReddito**

diagram																																			
namespace	urn:www.agenziaentrate.gov.it:specificheTecniche:sco:730																																		
type	restriction of <a href="#">DatoNP Type</a>																																		
facets	<table border="1"> <thead> <tr> <th>Kind</th> <th>Value</th> </tr> </thead> <tbody> <tr> <td>pattern</td> <td>[1-9]{1}[0-9]*</td> </tr> <tr> <td>enumeration</td> <td>1</td> </tr> <tr> <td>enumeration</td> <td>2</td> </tr> <tr> <td>enumeration</td> <td>3</td> </tr> <tr> <td>enumeration</td> <td>4</td> </tr> <tr> <td>enumeration</td> <td>5</td> </tr> <tr> <td>enumeration</td> <td>6</td> </tr> <tr> <td>enumeration</td> <td>7</td> </tr> <tr> <td>enumeration</td> <td>8</td> </tr> <tr> <td>enumeration</td> <td>9</td> </tr> <tr> <td>enumeration</td> <td>10</td> </tr> <tr> <td>enumeration</td> <td>11</td> </tr> <tr> <td>enumeration</td> <td>12</td> </tr> <tr> <td>enumeration</td> <td>13</td> </tr> <tr> <td>enumeration</td> <td>14</td> </tr> <tr> <td>enumeration</td> <td>15</td> </tr> </tbody> </table>	Kind	Value	pattern	[1-9]{1}[0-9]*	enumeration	1	enumeration	2	enumeration	3	enumeration	4	enumeration	5	enumeration	6	enumeration	7	enumeration	8	enumeration	9	enumeration	10	enumeration	11	enumeration	12	enumeration	13	enumeration	14	enumeration	15
Kind	Value																																		
pattern	[1-9]{1}[0-9]*																																		
enumeration	1																																		
enumeration	2																																		
enumeration	3																																		
enumeration	4																																		
enumeration	5																																		
enumeration	6																																		
enumeration	7																																		
enumeration	8																																		
enumeration	9																																		
enumeration	10																																		
enumeration	11																																		
enumeration	12																																		
enumeration	13																																		
enumeration	14																																		
enumeration	15																																		

#### element **Redditi\_Eredi\_Legatari\_Type/RedditoTotale**

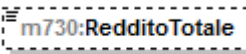
diagram					
namespace	urn:www.agenziaentrate.gov.it:specificheTecniche:sco:730				
type	<a href="#">DatoNP Type</a>				
facets	<table border="1"> <thead> <tr> <th>Kind</th> <th>Value</th> </tr> </thead> <tbody> <tr> <td>pattern</td> <td>[1-9]{1}[0-9]*</td> </tr> </tbody> </table>	Kind	Value	pattern	[1-9]{1}[0-9]*
Kind	Value				
pattern	[1-9]{1}[0-9]*				

#### element **Redditi\_Eredi\_Legatari\_Type/QuotalmposteSuccessioni**

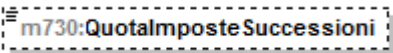
diagram					
namespace	urn:www.agenziaentrate.gov.it:specificheTecniche:sco:730				
type	<a href="#">DatoNP Type</a>				
facets	<table border="1"> <thead> <tr> <th>Kind</th> <th>Value</th> </tr> </thead> <tbody> <tr> <td>pattern</td> <td>[1-9]{1}[0-9]*</td> </tr> </tbody> </table>	Kind	Value	pattern	[1-9]{1}[0-9]*
Kind	Value				
pattern	[1-9]{1}[0-9]*				

complexType **Redditi\_Fabbricati\_Type**

diagram	
namespace	urn:www.agenziaentrate.gov.it:specificheTecniche:sco:730
children	<a href="#">m730:Modulo</a>

element **Redditi\_Fabbricati\_Type/Modulo**

diagram	
namespace	urn:www.agenziaentrate.gov.it:specificheTecniche:sco:730
type	<a href="#">m730:Modulo_Fabbricato_Type</a>
children	<a href="#">m730:FabbricatoOrd</a> <a href="#">m730:FabbricatoAgev</a>

complexType **Redditi\_Lavoro\_Dip\_Type**

diagram	<p>Quadro C - Redditi di Lavoro Dipendente e Assimilati</p>
namespace	urn:www.agenziaentrate.gov.it:specificheTecniche:sco:730
children	<a href="#">m730:PrimoModulo</a> <a href="#">m730:Modulo</a>

element **Redditi\_Lavoro\_Dip\_Type/PrimoModulo**

diagram	
namespace	urn:www.agenziaentrate.gov.it:specificheTecniche:sco:730
type	<a href="#">m730:Primo_Modulo_Lavoro_Dip_Type</a>
children	<a href="#">m730:LavoroDipendente</a> <a href="#">m730:PremiRisultato</a> <a href="#">m730:PeriodoLavoro</a> <a href="#">m730:AltriRedditiAssLavDip</a> <a href="#">m730:RitenuteLavoroDipendente</a> <a href="#">m730:Bonuslrpef</a> <a href="#">m730:CasellaCasiParticolari</a>

element **Redditi\_Lavoro\_Dip\_Type/Modulo**

diagram	
namespace	urn:www.agenziaentrate.gov.it:specificheTecniche:sco:730
type	<a href="#">m730:Modulo_Lavoro_Dip_Type</a>
children	<a href="#">m730:LavoroDipendente</a> <a href="#">m730:PremiRisultato</a> <a href="#">m730:AltriRedditiAssLavDip</a> <a href="#">m730:Bonuslrpef</a>

complexType **Redditi\_Ritenute\_Spese\_Type**

diagram	
namespace	urn:www.agenziaentrate.gov.it:specificheTecniche:sco:730
type	extension of <a href="#">m730:Redditi_Ritenute_Type</a>
children	<a href="#">m730:ImportoRedditi</a> <a href="#">m730:ImportoRitenute</a> <a href="#">m730:ImportoSpese</a>

element **Redditi\_Ritenute\_Spese\_Type/ImportoSpese**

diagram					
namespace	urn:www.agenziaentrate.gov.it:specificheTecniche:sco:730				
type	<a href="#">DatoNP_Type</a>				
facets	<table border="1"> <thead> <tr> <th>Kind</th> <th>Value</th> </tr> </thead> <tbody> <tr> <td>pattern</td> <td>[1-9]{1}[0-9]*</td> </tr> </tbody> </table>	Kind	Value	pattern	[1-9]{1}[0-9]*
Kind	Value				
pattern	[1-9]{1}[0-9]*				

complexType **Redditi\_Ritenute\_Type**

diagram	
namespace	urn:www.agenziaentrate.gov.it:specificheTecniche:sco:730
children	<a href="#">m730:ImportoRedditi</a> <a href="#">m730:ImportoRitenute</a>

element **Redditi\_Ritenute\_Type/ImportoRedditi**

diagram					
namespace	urn:www.agenziaentrate.gov.it:specificheTecniche:sco:730				
type	<a href="#">DatoNP_Type</a>				
facets	<table border="1"> <thead> <tr> <th>Kind</th> <th>Value</th> </tr> </thead> <tbody> <tr> <td>pattern</td> <td>[1-9]{1}[0-9]*</td> </tr> </tbody> </table>	Kind	Value	pattern	[1-9]{1}[0-9]*
Kind	Value				
pattern	[1-9]{1}[0-9]*				



element **Redditi\_Ritenute\_Type/ImportoRitenute**

diagram	
namespace	urn:www.agenziaentrate.gov.it:specificheTecniche:sco:730
type	<a href="#">DatoNP_Type</a>
facets	Kind Value pattern [1-9]{1}[0-9]*

complexType **Redditi\_Tassazione\_Separata\_Type**

diagram	
namespace	urn:www.agenziaentrate.gov.it:specificheTecniche:sco:730
children	<a href="#">m730:RedditiErede</a> <a href="#">m730:ImposteRimborsate</a>

element **Redditi\_Tassazione\_Separata\_Type/RedditiErede**

diagram	
namespace	urn:www.agenziaentrate.gov.it:specificheTecniche:sco:730
type	<a href="#">m730:Redditi Eredi Legatari_Type</a>
children	<a href="#">m730:Opzione</a> <a href="#">m730:Anno</a> <a href="#">m730:RedditoRitenute</a> <a href="#">m730:TipoReddito</a> <a href="#">m730:RedditoTotale</a> <a href="#">m730:QuotaImposteSuccessioni</a>

element **Redditi\_Tassazione\_Separata\_Type/ImposteRimborsate**

diagram	
namespace	urn:www.agenziaentrate.gov.it:specificheTecniche:sco:730
type	<a href="#">m730:Imposte_Rimborsate_Type</a>
children	<a href="#">m730:TipoReddito</a> <a href="#">m730:TassazioneSeparata</a>

complexType **Redditi\_Terreni\_Type**

diagram	
namespace	urn:www.agenziaentrate.gov.it:specificheTecniche:sco:730
children	<a href="#">m730:Modulo</a>

element **Redditi\_Terreni\_Type/Modulo**

diagram	
namespace	urn:www.agenziaentrate.gov.it:specificheTecniche:sco:730
type	<a href="#">m730:Modulo_Terreno_Type</a>
children	<a href="#">m730:Terreno</a>

complexType **Reddito\_Erede\_Type**

diagram	
namespace	urn:www.agenziaentrate.gov.it:specificheTecniche:sco:730

type	extension of <a href="#">m730:Tassazione Separata Type</a>
children	<a href="#">m730:Opzione</a> <a href="#">m730:Anno</a> <a href="#">m730:RedditoRitenute</a>

complexType **Residenza\_Anagrafica\_730\_Type**

diagram	
namespace	urn:www.agenziaentrate.gov.it:specificheTecniche:sco:730
type	extension of <a href="#">Residenza_Anagrafica_Type</a>
children	<a href="#">Comune</a> <a href="#">Provincia</a> <a href="#">CodiceComune</a> <a href="#">Indirizzo</a> <a href="#">Cap</a> <a href="#">DataVariazione</a> <a href="#">m730:Tipologia</a> <a href="#">m730:NumCivico</a> <a href="#">m730:Frazione</a> <a href="#">m730:PrimaPresentazione</a>

element **Residenza\_Anagrafica\_730\_Type/Tipologia**

diagram					
namespace	urn:www.agenziaentrate.gov.it:specificheTecniche:sco:730				
type	<a href="#">DatoAN_Type</a>				
facets	<table border="1"> <tr> <td>Kind</td> <td>Value</td> </tr> <tr> <td>pattern</td> <td>([0-9A-Z\-\]]&amp;quot;){1}([ 0-9A-Z&amp;amp;:] ' - \- . \! \° \^ \( \) \À \É \È \Ì \Ò \Ù \Ü &amp;quot; \ \\ \+)*</td> </tr> </table>	Kind	Value	pattern	([0-9A-Z\-\]]&quot;){1}([ 0-9A-Z&amp;:] ' - \- . \! \° \^ \( \) \À \É \È \Ì \Ò \Ù \Ü &quot; \ \\ \+)*
Kind	Value				
pattern	([0-9A-Z\-\]]&quot;){1}([ 0-9A-Z&amp;:] ' - \- . \! \° \^ \( \) \À \É \È \Ì \Ò \Ù \Ü &quot; \ \\ \+)*				

element **Residenza\_Anagrafica\_730\_Type/NumCivico**

diagram	
---------	--

namespace	urn:www.agenziaentrate.gov.it:specificheTecniche:sco:730
type	<a href="#">DatoAN_Type</a>
facets	Kind Value pattern ([0-9A-Z\-\&quot;]{1})([0-9A-Z&amp;] '\-\.\, /'^\(\)\) À É È Ì Ò Ù Û &quot; \ \ /+)*

element **Residenza\_Anagrafica\_730\_Type/Frazione**

diagram	
namespace	urn:www.agenziaentrate.gov.it:specificheTecniche:sco:730
type	<a href="#">DatoAN_Type</a>
facets	Kind Value pattern ([0-9A-Z\-\&quot;]{1})([0-9A-Z&amp;] '\-\.\, /'^\(\)\) À É È Ì Ò Ù Û &quot; \ \ /+)*

element **Residenza\_Anagrafica\_730\_Type/PrimaPresentazione**

diagram	
namespace	urn:www.agenziaentrate.gov.it:specificheTecniche:sco:730
type	<a href="#">DatoCB_Type</a>
facets	Kind Value pattern [01]

complexType **Residenza\_Rappresentante\_Type**

diagram	
namespace	urn:www.agenziaentrate.gov.it:specificheTecniche:sco:730
type	extension of <a href="#">Domicilio_Ita_Type</a>

children	<a href="#">Comune</a> <a href="#">Provincia</a> <a href="#">CodiceComune</a> <a href="#">Indirizzo</a> <a href="#">Cap</a> <a href="#">m730:Tipologia</a> <a href="#">m730:NumCivico</a> <a href="#">m730:Frazione</a>
----------	---

element **Residenza\_Rappresentante\_Type/Tipologia**

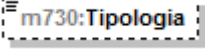
diagram	
namespace	urn:www.agenziaentrate.gov.it:specificheTecniche:sco:730
type	<a href="#">DatoAN_Type</a>
facets	Kind Value pattern ([0-9A-Z-]*)&quot;){1}([ 0-9A-Z&amp;:] [-\., /°\^\(\)\ À É È Ì Ò Ù Ü &quot; \ \\ / +)*

element **Residenza\_Rappresentante\_Type/NumCivico**

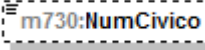
diagram	
namespace	urn:www.agenziaentrate.gov.it:specificheTecniche:sco:730
type	<a href="#">DatoAN_Type</a>
facets	Kind Value pattern ([0-9A-Z-]*)&quot;){1}([ 0-9A-Z&amp;:] [-\., /°\^\(\)\ À É È Ì Ò Ù Ü &quot; \ \\ / +)*

element **Residenza\_Rappresentante\_Type/Frazione**

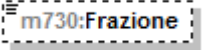
diagram	
namespace	urn:www.agenziaentrate.gov.it:specificheTecniche:sco:730
type	<a href="#">DatoAN_Type</a>
facets	Kind Value pattern ([0-9A-Z-]*)&quot;){1}([ 0-9A-Z&amp;:] [-\., /°\^\(\)\ À É È Ì Ò Ù Ü &quot; \ \\ / +)*

complexType **Residenza\_Type**

diagram	
namespace	urn:www.agenziaentrate.gov.it:specificheTecniche:sco:730
children	<a href="#">m730:Comune</a> <a href="#">m730:Provincia</a> <a href="#">m730:CodiceComune</a> <a href="#">m730:Cap</a> <a href="#">m730:Tipologia</a> <a href="#">m730:Indirizzo</a> <a href="#">m730:NumCivico</a> <a href="#">m730:Frazione</a> <a href="#">m730:Email</a> <a href="#">m730:Telefono</a>

element **Residenza\_Type/Comune**

diagram					
namespace	urn:www.agenziaentrate.gov.it:specificheTecniche:sco:730				
type	<a href="#">DatoAN_Type</a>				
facets	<table border="0"> <tr> <td>Kind</td> <td>Value</td> </tr> <tr> <td>pattern</td> <td>(([0-9A-Z-] \&amp;quot;){1}([ 0-9A-Z&amp;amp;] '\- \., / ^*\(\) \) \) \&amp;Agrave; \&amp;Eacute; \&amp;Ograve; \&amp;Ugrave; \&amp;quot; \&amp;backslash; +)*</td> </tr> </table>	Kind	Value	pattern	(([0-9A-Z-] \&quot;){1}([ 0-9A-Z&amp;] '\- \., / ^*\(\) \) \) \&Agrave; \&Eacute; \&Ograve; \&Ugrave; \&quot; \&backslash; +)*
Kind	Value				
pattern	(([0-9A-Z-] \&quot;){1}([ 0-9A-Z&amp;] '\- \., / ^*\(\) \) \) \&Agrave; \&Eacute; \&Ograve; \&Ugrave; \&quot; \&backslash; +)*				

element **Residenza\_Type/Provincia**

diagram	
namespace	urn:www.agenziaentrate.gov.it:specificheTecniche:sco:730
type	<a href="#">PR_Type</a>

element **Residenza\_Type/CodiceComune**

diagram	
---------	--

namespace	urn:www.agenziaentrate.gov.it:specificheTecniche:sco:730
type	<a href="#">DatoAN_Type</a>
facets	Kind Value pattern ([0-9A-Z\-\-]*)&quot;}{1}([ 0-9A-Z&amp;:] ' - \., / ^ \^\(\\ ) À É È Ì Ò Ù Û &quot; \\ / +)*

#### element **Residenza\_Type/Cap**

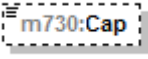
diagram	
namespace	urn:www.agenziaentrate.gov.it:specificheTecniche:sco:730
type	<a href="#">DatoAN_Type</a>
facets	Kind Value pattern ([0-9A-Z\-\-]*)&quot;}{1}([ 0-9A-Z&amp;:] ' - \., / ^ \^\(\\ ) À É È Ì Ò Ù Û &quot; \\ / +)*

#### element **Residenza\_Type/Tipologia**

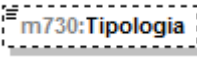
diagram	
namespace	urn:www.agenziaentrate.gov.it:specificheTecniche:sco:730
type	<a href="#">DatoAN_Type</a>
facets	Kind Value pattern ([0-9A-Z\-\-]*)&quot;}{1}([ 0-9A-Z&amp;:] ' - \., / ^ \^\(\\ ) À É È Ì Ò Ù Û &quot; \\ / +)*

#### element **Residenza\_Type/Indirizzo**

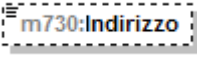
diagram	
namespace	urn:www.agenziaentrate.gov.it:specificheTecniche:sco:730
type	<a href="#">DatoAN_Type</a>
facets	Kind Value pattern ([0-9A-Z\-\-]*)&quot;}{1}([ 0-9A-Z&amp;:] ' - \., / ^ \^\(\\ ) À É È Ì Ò Ù Û &quot; \\ / +)*

#### element **Residenza\_Type/NumCivico**

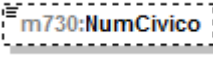
diagram	
namespace	urn:www.agenziaentrate.gov.it:specificheTecniche:sco:730
type	<a href="#">DatoAN_Type</a>
facets	Kind Value pattern ([0-9A-Z\-\-]*)&quot;}{1}([ 0-9A-Z&amp;:] ' - \., / ^ \^\(\\ ) À É È Ì Ò Ù Û &quot; \\ / +)*

### element **Residenza\_Type/Frazione**

diagram	
namespace	urn:www.agenziaentrate.gov.it:specificheTecniche:sco:730
type	<a href="#">DatoAN_Type</a>
facets	Kind Value pattern ([0-9A-Z-] \&quot;){1}([ 0-9A-Z&amp;:] ' \- \., / ^ \^\(\\ ) À É È Ì Ò Ù Û &quot; \\ / +)*

### element **Residenza\_Type/Email**

diagram	
namespace	urn:www.agenziaentrate.gov.it:specificheTecniche:sco:730
type	<a href="#">DatoEM_Type</a>
facets	Kind Value pattern [a-zA-Z0-9._%'\-'\&quot;?^~=]+@[a-zA-Z0-9.\-]+\.[a-zA-Z]{2,4}

### element **Residenza\_Type/Telefono**

diagram	
namespace	urn:www.agenziaentrate.gov.it:specificheTecniche:sco:730
type	<a href="#">DatoAN_Type</a>
facets	Kind Value pattern ([0-9A-Z-] \&quot;){1}([ 0-9A-Z&amp;:] ' \- \., / ^ \^\(\\ ) À É È Ì Ò Ù Û &quot; \\ / +)*

### complexType **Residuo\_Credito\_Compens\_Annolmposta\_Type**

diagram	
namespace	urn:www.agenziaentrate.gov.it:specificheTecniche:sco:730
type	extension of <a href="#">m730:Residuo_Credito_Compens_Type</a>
children	<a href="#">m730:CreditoAnno</a> <a href="#">m730:DiCuiCompensatoF24</a>

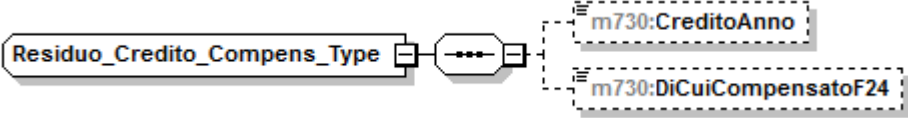

### complexType Residuo\_Credito\_Compens\_Type

diagram	
namespace	urn:www.agenziaentrate.gov.it:specificheTecniche:sco:730
children	<a href="#">m730:CreditoAnno</a> <a href="#">m730:DiCuiCompensatoF24</a>

### element Residuo\_Credito\_Compens\_Type/CreditoAnno

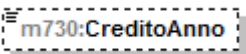
diagram					
namespace	urn:www.agenziaentrate.gov.it:specificheTecniche:sco:730				
type	<a href="#">DatoNP_Type</a>				
facets	<table border="1"> <tr> <td>Kind</td> <td>Value</td> </tr> <tr> <td>pattern</td> <td>[1-9]{1}[0-9]*</td> </tr> </table>	Kind	Value	pattern	[1-9]{1}[0-9]*
Kind	Value				
pattern	[1-9]{1}[0-9]*				

### element Residuo\_Credito\_Compens\_Type/DiCuiCompensatoF24

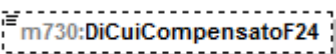
diagram					
namespace	urn:www.agenziaentrate.gov.it:specificheTecniche:sco:730				
type	<a href="#">DatoNP_Type</a>				
facets	<table border="1"> <tr> <td>Kind</td> <td>Value</td> </tr> <tr> <td>pattern</td> <td>[1-9]{1}[0-9]*</td> </tr> </table>	Kind	Value	pattern	[1-9]{1}[0-9]*
Kind	Value				
pattern	[1-9]{1}[0-9]*				

### complexType Residuo\_Fabbricati\_Type

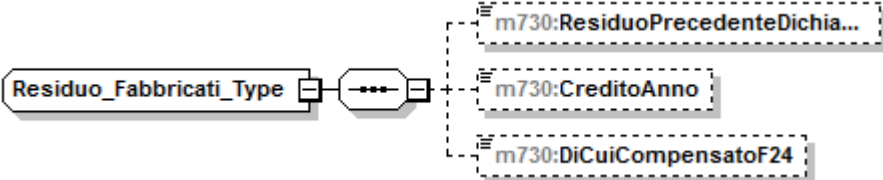
diagram	
namespace	urn:www.agenziaentrate.gov.it:specificheTecniche:sco:730
children	<a href="#">m730:ResiduoPrecedenteDichiarazione</a> <a href="#">m730:CreditoAnno</a> <a href="#">m730:DiCuiCompensatoF24</a>

### element Residuo\_Fabbricati\_Type/ResiduoPrecedenteDichiarazione

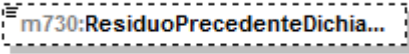
diagram	
namespace	urn:www.agenziaentrate.gov.it:specificheTecniche:sco:730
type	<a href="#">DatoNP_Type</a>

facets	Kind pattern	Value [1-9]{1}[0-9]*
--------	-----------------	-------------------------

#### element **Residuo\_Fabbricati\_Type/CreditoAnno**

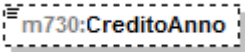
diagram		
namespace	urn:www.agenziaentrate.gov.it:specificheTecniche:sco:730	
type	<a href="#">DatoNP_Type</a>	
facets	Kind pattern	Value [1-9]{1}[0-9]*

#### element **Residuo\_Fabbricati\_Type/DiCuiCompensatoF24**

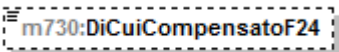
diagram		
namespace	urn:www.agenziaentrate.gov.it:specificheTecniche:sco:730	
type	<a href="#">DatoNP_Type</a>	
facets	Kind pattern	Value [1-9]{1}[0-9]*

#### complexType **Restituzione\_Somme\_Type**

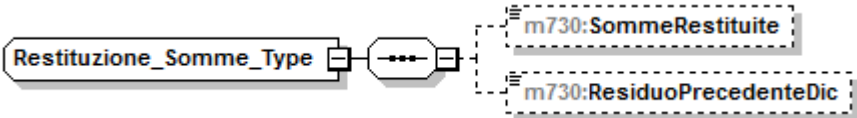
diagram	
namespace	urn:www.agenziaentrate.gov.it:specificheTecniche:sco:730
children	<a href="#">m730:SommeRestituite</a> <a href="#">m730:ResiduoPrecedenteDic</a>

#### element **Restituzione\_Somme\_Type/SommeRestituite**

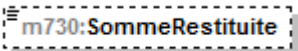
diagram		
namespace	urn:www.agenziaentrate.gov.it:specificheTecniche:sco:730	
type	<a href="#">DatoNP_Type</a>	
facets	Kind pattern	Value [1-9]{1}[0-9]*

#### element **Restituzione\_Somme\_Type/ResiduoPrecedenteDic**

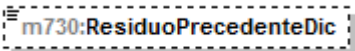
diagram	
namespace	urn:www.agenziaentrate.gov.it:specificheTecniche:sco:730

type	<a href="#">DatoNP_Type</a>
facets	Kind Value pattern [1-9]{1}[0-9]*

### complexType Rettifica\_Type

diagram	
namespace	urn:www.agenziaentrate.gov.it:specificheTecniche:sco:730
children	<a href="#">m730:Quadro</a> <a href="#">m730:Rigo</a> <a href="#">m730:Colonna</a> <a href="#">m730:Modulo</a> <a href="#">m730:DatoRimosso</a>

### element Rettifica\_Type/Quadro

diagram	
namespace	urn:www.agenziaentrate.gov.it:specificheTecniche:sco:730
type	<a href="#">DatoAN_Type</a>
facets	Kind Value pattern ([0-9A-Z\-\_]&quot;){1}([ 0-9A-Z&amp;#39; ! - \., / ^*\(\)\ À É È Ì Ò Ù Ú &quot; \ \\ /+)*

### element Rettifica\_Type/Rigo

diagram	
namespace	urn:www.agenziaentrate.gov.it:specificheTecniche:sco:730
type	<a href="#">DatoNP_Type</a>
facets	Kind Value pattern [1-9]{1}[0-9]*

### element Rettifica\_Type/Colonna

diagram	
namespace	urn:www.agenziaentrate.gov.it:specificheTecniche:sco:730
type	<a href="#">DatoNP_Type</a>
facets	Kind Value pattern [1-9]{1}[0-9]*

element **Rettifica\_Type/Modulo**

diagram	
namespace	urn:www.agenziaentrate.gov.it:specificheTecniche:sco:730
type	<a href="#">DatoNP_Type</a>
facets	Kind Value pattern [1-9]{1}[0-9]*

element **Rettifica\_Type/DatoRimosso**

diagram	
namespace	urn:www.agenziaentrate.gov.it:specificheTecniche:sco:730
type	<a href="#">DatoCB_Type</a>
facets	Kind Value pattern [01]

complexType **Riepilogo\_Redditi\_Type**

diagram	
namespace	urn:www.agenziaentrate.gov.it:specificheTecniche:sco:730
children	<a href="#">m730:Dominicali</a> <a href="#">m730:Agrari</a> <a href="#">m730:Fabbricati</a> <a href="#">m730:LavDip</a> <a href="#">m730:AltriRedditi</a> <a href="#">m730:ImponibileCedolare</a> <a href="#">m730:ImponibileCedolareOrdinario</a> <a href="#">m730:ImponibileCedolareAgevolato</a> <a href="#">m730:AbitazionePrincipalePertinenze</a>

**element Riepilogo\_Reddito\_Type/Dominicali**

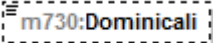
diagram	
namespace	urn:www.agenziaentrate.gov.it:specificheTecniche:sco:730
type	<a href="#">DatoNP_Type</a>
facets	Kind Value pattern [1-9]{1}[0-9]*

**element Riepilogo\_Reddito\_Type/Agrari**

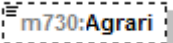
diagram	
namespace	urn:www.agenziaentrate.gov.it:specificheTecniche:sco:730
type	<a href="#">DatoNP_Type</a>
facets	Kind Value pattern [1-9]{1}[0-9]*

**element Riepilogo\_Reddito\_Type/Fabbricati**

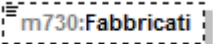
diagram	
namespace	urn:www.agenziaentrate.gov.it:specificheTecniche:sco:730
type	<a href="#">DatoNP_Type</a>
facets	Kind Value pattern [1-9]{1}[0-9]*

**element Riepilogo\_Reddito\_Type/LavDip**

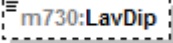
diagram	
namespace	urn:www.agenziaentrate.gov.it:specificheTecniche:sco:730
type	<a href="#">DatoNP_Type</a>
facets	Kind Value pattern [1-9]{1}[0-9]*

**element Riepilogo\_Reddito\_Type/AltriRedditi**

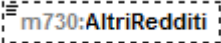
diagram	
namespace	urn:www.agenziaentrate.gov.it:specificheTecniche:sco:730
type	<a href="#">DatoNP_Type</a>
facets	Kind Value pattern [1-9]{1}[0-9]*

**element Riepilogo\_Redditi\_Type/ImponibileCedolare**

diagram	 m730:ImponibileCedolare				
namespace	urn:www.agenziaentrate.gov.it:specificheTecniche:sco:730				
type	<a href="#">DatoNP_Type</a>				
facets	<table border="1"> <tr> <td>Kind</td> <td>Value</td> </tr> <tr> <td>pattern</td> <td>[1-9]{1}[0-9]*</td> </tr> </table>	Kind	Value	pattern	[1-9]{1}[0-9]*
Kind	Value				
pattern	[1-9]{1}[0-9]*				

**element Riepilogo\_Redditi\_Type/ImponibileCedolareOrdinario**

diagram	 m730:ImponibileCedolareOrdina...				
namespace	urn:www.agenziaentrate.gov.it:specificheTecniche:sco:730				
type	<a href="#">DatoNP_Type</a>				
facets	<table border="1"> <tr> <td>Kind</td> <td>Value</td> </tr> <tr> <td>pattern</td> <td>[1-9]{1}[0-9]*</td> </tr> </table>	Kind	Value	pattern	[1-9]{1}[0-9]*
Kind	Value				
pattern	[1-9]{1}[0-9]*				

**element Riepilogo\_Redditi\_Type/ImponibileCedolareAgevolato**

diagram	 m730:ImponibileCedolareAgevo...				
namespace	urn:www.agenziaentrate.gov.it:specificheTecniche:sco:730				
type	<a href="#">DatoNP_Type</a>				
facets	<table border="1"> <tr> <td>Kind</td> <td>Value</td> </tr> <tr> <td>pattern</td> <td>[1-9]{1}[0-9]*</td> </tr> </table>	Kind	Value	pattern	[1-9]{1}[0-9]*
Kind	Value				
pattern	[1-9]{1}[0-9]*				

**element Riepilogo\_Redditi\_Type/AbitazionePrincipalePertinenze**

diagram	 m730:AbitazionePrincipalePertin...				
namespace	urn:www.agenziaentrate.gov.it:specificheTecniche:sco:730				
type	<a href="#">DatoNP_Type</a>				
facets	<table border="1"> <tr> <td>Kind</td> <td>Value</td> </tr> <tr> <td>pattern</td> <td>[1-9]{1}[0-9]*</td> </tr> </table>	Kind	Value	pattern	[1-9]{1}[0-9]*
Kind	Value				
pattern	[1-9]{1}[0-9]*				

complexType **Ritenute\_Acconti\_Sospesi\_Type**

diagram	
namespace	urn:www.agenziaentrate.gov.it:specificheTecniche:sco:730
children	<a href="#">m730:CodiceEvento</a> <a href="#">m730:lrpef</a> <a href="#">m730:AddRegionalelrpef</a> <a href="#">m730:AddComunalelrpef</a> <a href="#">m730:SostitutivaPremi</a> <a href="#">m730:CedolareSecca</a>

element **Ritenute\_Acconti\_Sospesi\_Type/CodiceEvento**

diagram																					
namespace	urn:www.agenziaentrate.gov.it:specificheTecniche:sco:730																				
type	<a href="#">m730:Codice Evento Eccezionale Type</a>																				
facets	<table border="1"> <thead> <tr> <th>Kind</th> <th>Value</th> </tr> </thead> <tbody> <tr> <td>pattern</td> <td>[1-9]{1}[0-9]*</td> </tr> <tr> <td>enumeration</td> <td>1</td> </tr> <tr> <td>enumeration</td> <td>2</td> </tr> <tr> <td>enumeration</td> <td>3</td> </tr> <tr> <td>enumeration</td> <td>4</td> </tr> <tr> <td>enumeration</td> <td>5</td> </tr> <tr> <td>enumeration</td> <td>6</td> </tr> <tr> <td>enumeration</td> <td>7</td> </tr> <tr> <td>enumeration</td> <td>8</td> </tr> </tbody> </table>	Kind	Value	pattern	[1-9]{1}[0-9]*	enumeration	1	enumeration	2	enumeration	3	enumeration	4	enumeration	5	enumeration	6	enumeration	7	enumeration	8
Kind	Value																				
pattern	[1-9]{1}[0-9]*																				
enumeration	1																				
enumeration	2																				
enumeration	3																				
enumeration	4																				
enumeration	5																				
enumeration	6																				
enumeration	7																				
enumeration	8																				

element **Ritenute\_Acconti\_Sospesi\_Type/lrpef**

diagram					
namespace	urn:www.agenziaentrate.gov.it:specificheTecniche:sco:730				
type	<a href="#">DatoNP Type</a>				
facets	<table border="1"> <thead> <tr> <th>Kind</th> <th>Value</th> </tr> </thead> <tbody> <tr> <td>pattern</td> <td>[1-9]{1}[0-9]*</td> </tr> </tbody> </table>	Kind	Value	pattern	[1-9]{1}[0-9]*
Kind	Value				
pattern	[1-9]{1}[0-9]*				

element **Ritenute\_Acconti\_Sospesi\_Type/AddRegionalelrpef**

diagram	
---------	--

namespace	urn:www.agenziaentrate.gov.it:specificheTecniche:sco:730
type	<a href="#">DatoNP_Type</a>
facets	Kind Value pattern [1-9]{1}[0-9]*

**element Ritenute\_Acconti\_Sospesi\_Type/AddComunalelrpef**

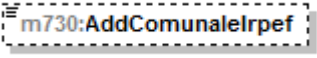
diagram	
namespace	urn:www.agenziaentrate.gov.it:specificheTecniche:sco:730
type	<a href="#">DatoNP_Type</a>
facets	Kind Value pattern [1-9]{1}[0-9]*

**element Ritenute\_Acconti\_Sospesi\_Type/SostitutivaPremi**

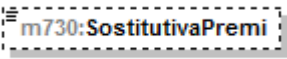
diagram	
namespace	urn:www.agenziaentrate.gov.it:specificheTecniche:sco:730
type	<a href="#">DatoNP_Type</a>
facets	Kind Value pattern [1-9]{1}[0-9]*

**element Ritenute\_Acconti\_Sospesi\_Type/CedolareSecca**

diagram	
namespace	urn:www.agenziaentrate.gov.it:specificheTecniche:sco:730
type	<a href="#">DatoNP_Type</a>
facets	Kind Value pattern [1-9]{1}[0-9]*

**complexType Ritenute\_Lavoro\_Dip\_Type**

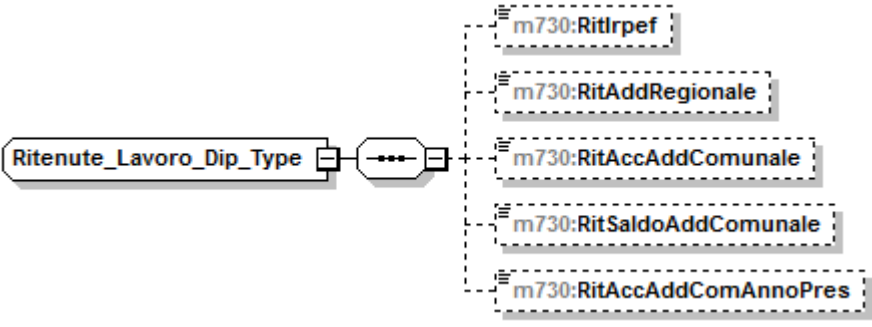
diagram	
namespace	urn:www.agenziaentrate.gov.it:specificheTecniche:sco:730



children	<a href="#">m730:Ritlrpef</a> <a href="#">m730:RitAddRegionale</a> <a href="#">m730:RitAccAddComunale</a> <a href="#">m730:RitSaldoAddComunale</a> <a href="#">m730:RitAccAddComAnnoPres</a>
----------	---

#### element **Ritenute\_Lavoro\_Dip\_Type/Ritlrpef**

diagram	
namespace	urn:www.agenziaentrategov.it:specificheTecniche:sco:730
type	<a href="#">DatoNP_Type</a>
facets	Kind Value pattern [1-9]{1}[0-9]*

#### element **Ritenute\_Lavoro\_Dip\_Type/RitAddRegionale**

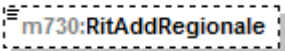
diagram	
namespace	urn:www.agenziaentrategov.it:specificheTecniche:sco:730
type	<a href="#">DatoNP_Type</a>
facets	Kind Value pattern [1-9]{1}[0-9]*

#### element **Ritenute\_Lavoro\_Dip\_Type/RitAccAddComunale**

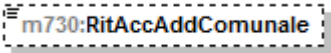
diagram	
namespace	urn:www.agenziaentrategov.it:specificheTecniche:sco:730
type	<a href="#">DatoNP_Type</a>
facets	Kind Value pattern [1-9]{1}[0-9]*

#### element **Ritenute\_Lavoro\_Dip\_Type/RitSaldoAddComunale**

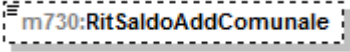
diagram	
namespace	urn:www.agenziaentrategov.it:specificheTecniche:sco:730
type	<a href="#">DatoNP_Type</a>
facets	Kind Value pattern [1-9]{1}[0-9]*

#### element **Ritenute\_Lavoro\_Dip\_Type/RitAccAddComAnnoPres**

diagram	
namespace	urn:www.agenziaentrategov.it:specificheTecniche:sco:730

type	<a href="#">DatoNP_Type</a>
facets	Kind Value pattern [1-9]{1}[0-9]*

### complexType Sezione\_Altri\_Redd\_Type

diagram	
namespace	urn:www.agenziaentrate.gov.it:specificheTecniche:sco:730
children	<a href="#">m730:TipoReddito</a> <a href="#">m730:RedditiRitenute</a>

### element Sezione\_Altri\_Redd\_Type/TipoReddito

diagram	
namespace	urn:www.agenziaentrate.gov.it:specificheTecniche:sco:730
type	<a href="#">m730:Tipo_Reddito_Da1a8_Type</a>
facets	Kind Value pattern [1-9]{1}[0-9]* enumeration 1 enumeration 2 enumeration 3 enumeration 4 enumeration 5 enumeration 6 enumeration 7 enumeration 8

### element Sezione\_Altri\_Redd\_Type/RedditiRitenute

diagram	
namespace	urn:www.agenziaentrate.gov.it:specificheTecniche:sco:730
type	<a href="#">m730:Redditi_Ritenute_Type</a>
children	<a href="#">m730:ImportoRedditi</a> <a href="#">m730:ImportoRitenute</a>

complexType **Sezione\_Dati\_Catastali\_Recupero\_Patrimonio\_Edilizio\_Type**

diagram	
namespace	urn:www.agenziaentrate.gov.it:specificheTecniche:sco:730
children	<a href="#">m730:DatiCatastaliRecuperoPatrimonioEdilizio</a> <a href="#">m730:DatiRegistrazioneAccatastamentoRecuperoPatrimonio_Edilizio</a>

element

**Sezione\_Dati\_Catastali\_Recupero\_Patrimonio\_Edilizio\_Type/DatiCatastaliRecuperoPatrimonioEdilizio**

diagram	
namespace	urn:www.agenziaentrate.gov.it:specificheTecniche:sco:730
type	extension of <a href="#">m730:Dati_Catastali_Recupero_Patrimonio_Edilizio_Type</a>
children	<a href="#">m730:NOrdImmobile</a> <a href="#">m730:Condominio</a> <a href="#">m730:DatiCatastali</a>

element

**Sezione\_Dati\_Catastali\_Recupero\_Patrimonio\_Edilizio\_Type/DatiRegistrazioneAccatastamentoRecuperoPatrimonio\_Edilizio**

diagram	
namespace	urn:www.agenziaentrate.gov.it:specificheTecniche:sco:730
type	<a href="#">m730:Dati_Registrazione_Accatastamento_Recupero_Patrimonio_Edilizio_Type</a>
children	<a href="#">m730:NOrdImmobile</a> <a href="#">m730:Condominio</a> <a href="#">m730:EstremiRegistrazioneContratto</a> <a href="#">m730:DomandaAccatastamento</a>

complexType **Soggetto\_Assistenza\_Fiscale\_Doc\_Type**

diagram	
namespace	urn:www.agenziaentrate.gov.it:specificheTecniche:sco:730
children	<a href="#">m730:DataConsegna</a> <a href="#">m730:TipologiaSoggettoAssFisc</a> <a href="#">m730:SostitutoCF</a> <a href="#">m730:DatiCafDoc</a> <a href="#">m730:DatiProfessionistaDoc</a> <a href="#">m730:DatiAssociazioneDoc</a> <a href="#">m730:AgenziaEntrate</a>

element **Soggetto\_Assistenza\_Fiscale\_Doc\_Type/DataConsegna**

diagram					
namespace	urn:www.agenziaentrate.gov.it:specificheTecniche:sco:730				
type	<a href="#">DatoDT_Type</a>				
facets	<table border="1"> <thead> <tr> <th>Kind</th> <th>Value</th> </tr> </thead> <tbody> <tr> <td>pattern</td> <td>((([0-9]{12}[0-9]{3}[01])(0[13578][10]12)\d{4}) ((([0-9]{12}[0-9]{30})(0[469][11]\d{4}) ((0[1-9][1-9]2[0-8])(02)\d{4})) ((29)(02)([02468][048]00)) ((29)(02)([13579][26]00)) ((29)(02)([0-9][0-9][0][48]) ((29)(02)([0-9][0-9][2468][048]) ((29)(02)([0-9][0-9][13579][26]))))</td> </tr> </tbody> </table>	Kind	Value	pattern	((([0-9]{12}[0-9]{3}[01])(0[13578][10]12)\d{4}) ((([0-9]{12}[0-9]{30})(0[469][11]\d{4}) ((0[1-9][1-9]2[0-8])(02)\d{4})) ((29)(02)([02468][048]00)) ((29)(02)([13579][26]00)) ((29)(02)([0-9][0-9][0][48]) ((29)(02)([0-9][0-9][2468][048]) ((29)(02)([0-9][0-9][13579][26]))))
Kind	Value				
pattern	((([0-9]{12}[0-9]{3}[01])(0[13578][10]12)\d{4}) ((([0-9]{12}[0-9]{30})(0[469][11]\d{4}) ((0[1-9][1-9]2[0-8])(02)\d{4})) ((29)(02)([02468][048]00)) ((29)(02)([13579][26]00)) ((29)(02)([0-9][0-9][0][48]) ((29)(02)([0-9][0-9][2468][048]) ((29)(02)([0-9][0-9][13579][26]))))				

element **Soggetto\_Assistenza\_Fiscale\_Doc\_Type/TipologiaSoggettoAssFisc**

diagram															
namespace	urn:www.agenziaentrate.gov.it:specificheTecniche:sco:730														
type	<a href="#">m730:Tipologia_Soggetto_Ass_Fisc_Type</a>														
facets	<table border="1"> <thead> <tr> <th>Kind</th> <th>Value</th> </tr> </thead> <tbody> <tr> <td>pattern</td> <td>[1-9]</td> </tr> <tr> <td>enumeration</td> <td>1</td> </tr> <tr> <td>enumeration</td> <td>2</td> </tr> <tr> <td>enumeration</td> <td>3</td> </tr> <tr> <td>enumeration</td> <td>4</td> </tr> <tr> <td>enumeration</td> <td>5</td> </tr> </tbody> </table>	Kind	Value	pattern	[1-9]	enumeration	1	enumeration	2	enumeration	3	enumeration	4	enumeration	5
Kind	Value														
pattern	[1-9]														
enumeration	1														
enumeration	2														
enumeration	3														
enumeration	4														
enumeration	5														

element **Soggetto\_Assistenza\_Fiscale\_Doc\_Type/SostitutoCF**

diagram	
---------	--

namespace	urn:www.agenziaentrate.gov.it:specificheTecniche:sco:730	
type	<a href="#">DatoCF_Type</a>	
facets	Kind	Value
	pattern	[0-9]{11}[A-Z]{6}[0-9LMNPQRSTU]{2}[A-Z]{1}[0-9LMNPQRSTU]{2}[A-Z]{1}[0-9LMNPQRSTU]{3}[A-Z]{1}

element **Soggetto\_Assistenza\_Fiscale\_Doc\_Type/DatiCafDoc**

diagram		
namespace	urn:www.agenziaentrate.gov.it:specificheTecniche:sco:730	
type	extension of <a href="#">m730:Dati_CAF_Type</a>	
children	<a href="#">m730:CFCaf</a> <a href="#">m730:DenominazioneCaf</a> <a href="#">m730:NumeroAlbo</a> <a href="#">m730:CFResponsabile</a> <a href="#">m730:CognomeResponsabile</a> <a href="#">m730:NomeResponsabile</a> <a href="#">m730:CFSocServizi</a> <a href="#">m730:IdSedePeriferica</a> <a href="#">m730:CasellaAttestazioneCaf</a>	

element **Soggetto\_Assistenza\_Fiscale\_Doc\_Type/DatiCafDoc/CFResponsabile**

diagram		
namespace	urn:www.agenziaentrate.gov.it:specificheTecniche:sco:730	
type	<a href="#">DatoCF_Type</a>	
facets	Kind	Value
	pattern	[0-9]{11}[A-Z]{6}[0-9LMNPQRSTU]{2}[A-Z]{1}[0-9LMNPQRSTU]{2}[A-Z]{1}[0-9LMNPQRSTU]{3}[A-Z]{1}

element **Soggetto\_Assistenza\_Fiscale\_Doc\_Type/DatiCafDoc/CognomeResponsabile**

diagram	
---------	--

namespace	urn:www.agenziaentrate.gov.it:specificheTecniche:sco:730
type	<a href="#">DatoAN_Type</a>
facets	Kind Value pattern ([0-9A-Z\-\] \&quot;){1}([ 0-9A-Z&amp;] ' \" \- \. , / ° \"\\(\ \\) À É È Ì Ò Ù Ü &quot; \\\"\\ \\+)*

element **Soggetto\_Assistenza\_Fiscale\_Doc\_Type/DatiCafDoc/NomeResponsabile**

diagram	
namespace	urn:www.agenziaentrate.gov.it:specificheTecniche:sco:730
type	<a href="#">DatoAN_Type</a>
facets	Kind Value pattern ([0-9A-Z\-\] \&quot;){1}([ 0-9A-Z&amp;] ' \" \- \. , / ° \"\\(\ \\) À É È Ì Ò Ù Ü &quot; \\\"\\ \\+)*

element **Soggetto\_Assistenza\_Fiscale\_Doc\_Type/DatiCafDoc/CF Soc Servizi**

diagram	
namespace	urn:www.agenziaentrate.gov.it:specificheTecniche:sco:730
type	<a href="#">DatoCN_Type</a>
facets	Kind Value pattern [0-9]{11}

element **Soggetto\_Assistenza\_Fiscale\_Doc\_Type/DatiCafDoc/IdSedePeriferica**

diagram	
namespace	urn:www.agenziaentrate.gov.it:specificheTecniche:sco:730
type	<a href="#">DatoAN_Type</a>
facets	Kind Value pattern ([0-9A-Z\-\] \&quot;){1}([ 0-9A-Z&amp;] ' \" \- \. , / ° \"\\(\ \\) À É È Ì Ò Ù Ü &quot; \\\"\\ \\+)*

element **Soggetto\_Assistenza\_Fiscale\_Doc\_Type/DatiCafDoc/CasellaAttestazioneCaf**

diagram	
namespace	urn:www.agenziaentrate.gov.it:specificheTecniche:sco:730
type	<a href="#">DatoCB_Type</a>
facets	Kind Value pattern [01]

element **Soggetto\_Assistenza\_Fiscale\_Doc\_Type/DatiProfessionistaDoc**

diagram	<p>The diagram shows a class <code>m730:DatiProfessionistaDoc</code> on the left. A dashed box labeled <code>m730:Dati_Professionista_Type (extension)</code> contains three classes: <code>m730:CFProfessionista</code>, <code>m730:CognomeProfessionista</code>, and <code>m730:NomeProfessionista</code>. A solid line with an open arrowhead points from <code>m730:DatiProfessionistaDoc</code> to the extension box. A solid line with a filled arrowhead points from <code>m730:DatiProfessionistaDoc</code> to <code>m730:DatiNascitaProfessionista</code>, which has a plus sign in its bottom right corner.</p>
namespace	urn:www.agenziaentrate.gov.it:specificheTecniche:sco:730
type	extension of <a href="#">m730:Dati Professionista Type</a>
children	<a href="#">m730:CFProfessionista</a> <a href="#">m730:CognomeProfessionista</a> <a href="#">m730:NomeProfessionista</a> <a href="#">m730:DatiNascitaProfessionista</a>

element **Soggetto\_Assistenza\_Fiscale\_Doc\_Type/DatiProfessionistaDoc/DatiNascitaProfessionista**

diagram	<p>The diagram shows a class <code>m730:DatiNascitaProfessionista</code> on the left. A dashed box labeled <code>m730:Dati_Nascita_PF_Type</code> contains four classes: <code>m730:Sesso</code>, <code>m730:DataNascita</code>, <code>m730:ComuneNascita</code>, and <code>m730:ProvinciaNascita</code>. A solid line with an open arrowhead points from <code>m730:DatiNascitaProfessionista</code> to the extension box. The <code>m730:ProvinciaNascita</code> class is shown with a dashed border.</p>
namespace	urn:www.agenziaentrate.gov.it:specificheTecniche:sco:730
type	<a href="#">m730:Dati_Nascita_PF_Type</a>
children	<a href="#">m730:Sesso</a> <a href="#">m730:DataNascita</a> <a href="#">m730:ComuneNascita</a> <a href="#">m730:ProvinciaNascita</a>

element **Soggetto\_Assistenza\_Fiscale\_Doc\_Type/DatiAssociazioneDoc**

diagram	
namespace	urn:www.agenziaentrate.gov.it:specificheTecniche:sco:730
type	extension of <a href="#">m730:Dati_Associazioni_Professionale_Type</a>
children	<a href="#">m730:CFAssociazione</a> <a href="#">m730:DenominazioneAssociazione</a> <a href="#">m730:CFProfessionista</a> <a href="#">m730:CognomeProfessionista</a> <a href="#">m730:NomeProfessionista</a> <a href="#">m730:DatiNascitaProfessionista</a>

element **Soggetto\_Assistenza\_Fiscale\_Doc\_Type/DatiAssociazioneDoc/DatiNascitaProfessionista**

diagram	
namespace	urn:www.agenziaentrate.gov.it:specificheTecniche:sco:730
type	<a href="#">m730:Dati_Nascita_PF_Type</a>
children	<a href="#">m730:Sesso</a> <a href="#">m730:DataNascita</a> <a href="#">m730:ComuneNascita</a> <a href="#">m730:ProvinciaNascita</a>

element **Soggetto\_Assistenza\_Fiscale\_Doc\_Type/AgenziaEntrate**

diagram					
namespace	urn:www.agenziaentrate.gov.it:specificheTecniche:sco:730				
type	<a href="#">DatoCB_Type</a>				
facets	<table border="1"> <thead> <tr> <th>Kind</th> <th>Value</th> </tr> </thead> <tbody> <tr> <td>pattern</td> <td>[01]</td> </tr> </tbody> </table>	Kind	Value	pattern	[01]
Kind	Value				
pattern	[01]				

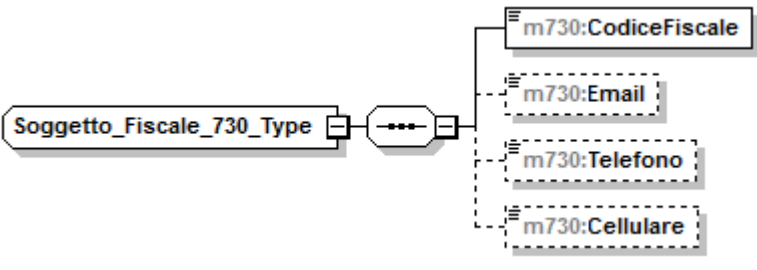

complexType **Soggetto\_Fiscale\_730\_Type**

diagram	
namespace	urn:www.agenziaentrate.gov.it:specificheTecniche:sco:730
children	<a href="#">m730:CodiceFiscale</a> <a href="#">m730:Email</a> <a href="#">m730:Telefono</a> <a href="#">m730:Cellulare</a>

element **Soggetto\_Fiscale\_730\_Type/CodiceFiscale**

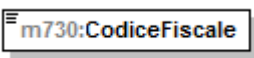
diagram					
namespace	urn:www.agenziaentrate.gov.it:specificheTecniche:sco:730				
type	<a href="#">DatoCF_Type</a>				
facets	<table border="1"> <thead> <tr> <th>Kind</th> <th>Value</th> </tr> </thead> <tbody> <tr> <td>pattern</td> <td>[0-9]{11}[A-Z]{6}[0-9LMNPQRSTU]{2}[A-Z]{1}[0-9LMNPQRSTU]{2}[A-Z]{1}[0-9LMNPQRSTU]{3}[A-Z]{1}</td> </tr> </tbody> </table>	Kind	Value	pattern	[0-9]{11}[A-Z]{6}[0-9LMNPQRSTU]{2}[A-Z]{1}[0-9LMNPQRSTU]{2}[A-Z]{1}[0-9LMNPQRSTU]{3}[A-Z]{1}
Kind	Value				
pattern	[0-9]{11}[A-Z]{6}[0-9LMNPQRSTU]{2}[A-Z]{1}[0-9LMNPQRSTU]{2}[A-Z]{1}[0-9LMNPQRSTU]{3}[A-Z]{1}				

element **Soggetto\_Fiscale\_730\_Type/Email**

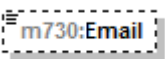
diagram					
namespace	urn:www.agenziaentrate.gov.it:specificheTecniche:sco:730				
type	<a href="#">DatoEM_Type</a>				
facets	<table border="1"> <thead> <tr> <th>Kind</th> <th>Value</th> </tr> </thead> <tbody> <tr> <td>pattern</td> <td>[a-zA-Z0-9._%'\-&amp;quot;?^~=]+@[a-zA-Z0-9.\-]+\.[a-zA-Z]{2,4}</td> </tr> </tbody> </table>	Kind	Value	pattern	[a-zA-Z0-9._%'\-&quot;?^~=]+@[a-zA-Z0-9.\-]+\.[a-zA-Z]{2,4}
Kind	Value				
pattern	[a-zA-Z0-9._%'\-&quot;?^~=]+@[a-zA-Z0-9.\-]+\.[a-zA-Z]{2,4}				

element **Soggetto\_Fiscale\_730\_Type/Telefono**

diagram					
namespace	urn:www.agenziaentrate.gov.it:specificheTecniche:sco:730				
type	<a href="#">DatoAN_Type</a>				
facets	<table border="1"> <thead> <tr> <th>Kind</th> <th>Value</th> </tr> </thead> <tbody> <tr> <td>pattern</td> <td>(([0-9A-Z-])&amp;quot;){1}([0-9A-Z&amp;amp;:] [-\., / ° ^\(\) À È É Ì Ò Ù Û &amp;quot; \\ / +)*</td> </tr> </tbody> </table>	Kind	Value	pattern	(([0-9A-Z-])&quot;){1}([0-9A-Z&amp;:] [-\., / ° ^\(\) À È É Ì Ò Ù Û &quot; \\ / +)*
Kind	Value				
pattern	(([0-9A-Z-])&quot;){1}([0-9A-Z&amp;:] [-\., / ° ^\(\) À È É Ì Ò Ù Û &quot; \\ / +)*				

element **Soggetto\_Fiscale\_730\_Type/Cellulare**

diagram					
namespace	urn:www.agenziaentrate.gov.it:specificheTecniche:sco:730				
type	<a href="#">DatoAN_Type</a>				
facets	<table border="1"> <thead> <tr> <th>Kind</th> <th>Value</th> </tr> </thead> <tbody> <tr> <td>pattern</td> <td>(([0-9A-Z-] \&amp;quot;){1}([ 0-9A-Z&amp;amp;:] [-\., / \^\\(\)\À È É Ì Ò Ù Ü &amp;quot; \ \\ /+)*</td> </tr> </tbody> </table>	Kind	Value	pattern	(([0-9A-Z-] \&quot;){1}([ 0-9A-Z&amp;:] [-\., / \^\\(\)\À È É Ì Ò Ù Ü &quot; \ \\ /+)*
Kind	Value				
pattern	(([0-9A-Z-] \&quot;){1}([ 0-9A-Z&amp;:] [-\., / \^\\(\)\À È É Ì Ò Ù Ü &quot; \ \\ /+)*				

complexType **Soglie\_Esenzione\_Type**

diagram	
namespace	urn:www.agenziaentrate.gov.it:specificheTecniche:sco:730
children	<a href="#">m730:SogliaEsenzione</a> <a href="#">m730:EsenzioneTotale</a>

element **Soglie\_Esenzione\_Type/SogliaEsenzione**

diagram					
namespace	urn:www.agenziaentrate.gov.it:specificheTecniche:sco:730				
type	<a href="#">DatoNP_Type</a>				
facets	<table border="1"> <thead> <tr> <th>Kind</th> <th>Value</th> </tr> </thead> <tbody> <tr> <td>pattern</td> <td>[1-9]{1}[0-9]*</td> </tr> </tbody> </table>	Kind	Value	pattern	[1-9]{1}[0-9]*
Kind	Value				
pattern	[1-9]{1}[0-9]*				

element **Soglie\_Esenzione\_Type/EsenzioneTotale**

diagram									
namespace	urn:www.agenziaentrate.gov.it:specificheTecniche:sco:730								
type	restriction of <a href="#">DatoN1_Type</a>								
facets	<table border="1"> <thead> <tr> <th>Kind</th> <th>Value</th> </tr> </thead> <tbody> <tr> <td>pattern</td> <td>[1-9]</td> </tr> <tr> <td>enumeration</td> <td>1</td> </tr> <tr> <td>enumeration</td> <td>2</td> </tr> </tbody> </table>	Kind	Value	pattern	[1-9]	enumeration	1	enumeration	2
Kind	Value								
pattern	[1-9]								
enumeration	1								
enumeration	2								



element **Sostituto\_Type/DatiAnagraficiPF/Nome**

diagram	
namespace	urn:www.agenziaentrate.gov.it:specificheTecniche:sco:730
type	<a href="#">DatoAN_Type</a>
facets	Kind Value pattern ([0-9A-Z-] \&quot;){1}([ 0-9A-Z&amp;:] \- \., / \^\(\ \) À É È Ì Ò Ù Û \&quot; \ \\ \ +)*

element **Sostituto\_Type/DenominazionePNF**

diagram	
namespace	urn:www.agenziaentrate.gov.it:specificheTecniche:sco:730
type	<a href="#">DatoAN_Type</a>
facets	Kind Value pattern ([0-9A-Z-] \&quot;){1}([ 0-9A-Z&amp;:] \- \., / \^\(\ \) À É È Ì Ò Ù Û \&quot; \ \\ \ +)*

element **Sostituto\_Type/Residenza**

diagram	
namespace	urn:www.agenziaentrate.gov.it:specificheTecniche:sco:730
type	<a href="#">m730:Residenza_Type</a>
children	<a href="#">m730:Comune</a> <a href="#">m730:Provincia</a> <a href="#">m730:CodiceComune</a> <a href="#">m730:Cap</a> <a href="#">m730:Tipologia</a> <a href="#">m730:Indirizzo</a> <a href="#">m730:NumCivico</a> <a href="#">m730:Frazione</a> <a href="#">m730:Email</a> <a href="#">m730:Telefono</a>

element **Sostituto\_Type/Fax**

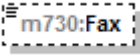
diagram	
namespace	urn:www.agenziaentrate.gov.it:specificheTecniche:sco:730
type	<a href="#">DatoAN_Type</a>
facets	Kind Value pattern ([0-9A-Z\-\-]&quot;){1}([ 0-9A-Z&amp;:] ' \- \., / ^ \^\(\\) À È É Ì Ò Ù Û &quot; \\ /+)*

element **Sostituto\_Type/CodiceSede**

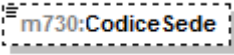
diagram	
namespace	urn:www.agenziaentrate.gov.it:specificheTecniche:sco:730
type	<a href="#">DatoAN_Type</a>
facets	Kind Value pattern ([0-9A-Z\-\-]&quot;){1}([ 0-9A-Z&amp;:] ' \- \., / ^ \^\(\\) À È É Ì Ò Ù Û &quot; \\ /+)*

complexType **Spese\_Arredo\_Giovani\_Coppie\_Type**

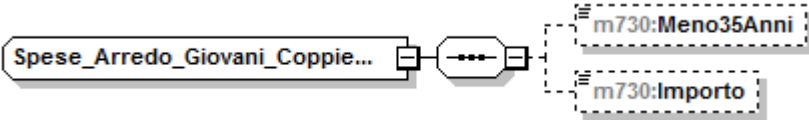
diagram	
namespace	urn:www.agenziaentrate.gov.it:specificheTecniche:sco:730
children	<a href="#">m730:Meno35Anni</a> <a href="#">m730:Importo</a>

element **Spese\_Arredo\_Giovani\_Coppie\_Type/Meno35Anni**

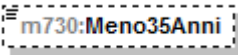
diagram	
namespace	urn:www.agenziaentrate.gov.it:specificheTecniche:sco:730
type	<a href="#">DatoCB_Type</a>
facets	Kind Value pattern [01]

element **Spese\_Arredo\_Giovani\_Coppie\_Type/Importo**

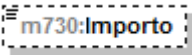
diagram	
namespace	urn:www.agenziaentrate.gov.it:specificheTecniche:sco:730
type	<a href="#">DatoNP_Type</a>
facets	Kind Value pattern [1-9]{1}[0-9]*

complexType **Spese\_Arredo\_Type**

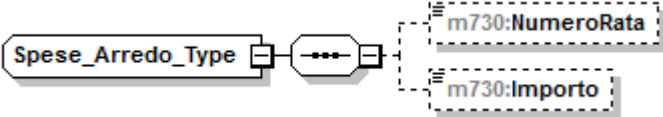
diagram	
namespace	urn:www.agenziaentrate.gov.it:specificheTecniche:sco:730
children	<a href="#">m730:NumeroRata</a> <a href="#">m730:Importo</a>

element **Spese\_Arredo\_Type/NumeroRata**

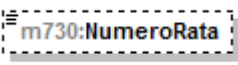
diagram															
namespace	urn:www.agenziaentrate.gov.it:specificheTecniche:sco:730														
type	restriction of <a href="#">DatoNP_Type</a>														
facets	<table border="1"> <thead> <tr> <th>Kind</th> <th>Value</th> </tr> </thead> <tbody> <tr> <td>pattern</td> <td>[1-9]{1}[0-9]*</td> </tr> <tr> <td>enumeration</td> <td>1</td> </tr> <tr> <td>enumeration</td> <td>2</td> </tr> <tr> <td>enumeration</td> <td>3</td> </tr> <tr> <td>enumeration</td> <td>4</td> </tr> <tr> <td>enumeration</td> <td>5</td> </tr> </tbody> </table>	Kind	Value	pattern	[1-9]{1}[0-9]*	enumeration	1	enumeration	2	enumeration	3	enumeration	4	enumeration	5
Kind	Value														
pattern	[1-9]{1}[0-9]*														
enumeration	1														
enumeration	2														
enumeration	3														
enumeration	4														
enumeration	5														

element **Spese\_Arredo\_Type/Importo**

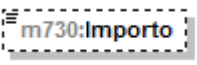
diagram					
namespace	urn:www.agenziaentrate.gov.it:specificheTecniche:sco:730				
type	<a href="#">DatoNP_Type</a>				
facets	<table border="1"> <thead> <tr> <th>Kind</th> <th>Value</th> </tr> </thead> <tbody> <tr> <td>pattern</td> <td>[1-9]{1}[0-9]*</td> </tr> </tbody> </table>	Kind	Value	pattern	[1-9]{1}[0-9]*
Kind	Value				
pattern	[1-9]{1}[0-9]*				

complexType **Spese\_Leasing\_Type**

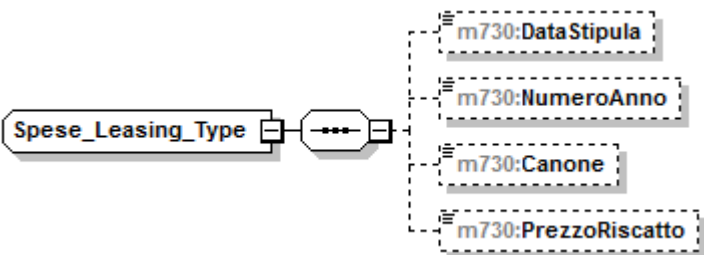
diagram	
namespace	urn:www.agenziaentrate.gov.it:specificheTecniche:sco:730
children	<a href="#">m730:DataStipula</a> <a href="#">m730:NumeroAnno</a> <a href="#">m730:Canone</a> <a href="#">m730:PrezzoRiscatto</a>

element **Spese\_Leasing\_Type/DataStipula**

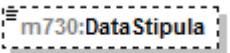
diagram					
namespace	urn:www.agenziaentrate.gov.it:specificheTecniche:sco:730				
type	<a href="#">DatoDT_Type</a>				
facets	<table border="0"> <tr> <td>Kind</td> <td>Value</td> </tr> <tr> <td>pattern</td> <td>((([0-9]{1,2}[0-9]{3,4}) (0[13578][1012]\d{4})) ((([0-9]{1,2}[0-9]{3,4}) (0[469][11]\d{4})) ((([0-9]{1,2}[0-9]{2,8})(02)\d{4})) ((29)(02)([02468][048]00)) ((29)(02)([13579][26]00)) ((29)(02)([0-9][0][48])) ((29)(02)([0-9][0-9][2468][048])) ((29)(02)([0-9][13579][26]))))</td> </tr> </table>	Kind	Value	pattern	((([0-9]{1,2}[0-9]{3,4}) (0[13578][1012]\d{4})) ((([0-9]{1,2}[0-9]{3,4}) (0[469][11]\d{4})) ((([0-9]{1,2}[0-9]{2,8})(02)\d{4})) ((29)(02)([02468][048]00)) ((29)(02)([13579][26]00)) ((29)(02)([0-9][0][48])) ((29)(02)([0-9][0-9][2468][048])) ((29)(02)([0-9][13579][26]))))
Kind	Value				
pattern	((([0-9]{1,2}[0-9]{3,4}) (0[13578][1012]\d{4})) ((([0-9]{1,2}[0-9]{3,4}) (0[469][11]\d{4})) ((([0-9]{1,2}[0-9]{2,8})(02)\d{4})) ((29)(02)([02468][048]00)) ((29)(02)([13579][26]00)) ((29)(02)([0-9][0][48])) ((29)(02)([0-9][0-9][2468][048])) ((29)(02)([0-9][13579][26]))))				

element **Spese\_Leasing\_Type/NumeroAnno**

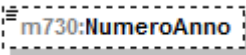
diagram									
namespace	urn:www.agenziaentrate.gov.it:specificheTecniche:sco:730								
type	restriction of <a href="#">DatoNP_Type</a>								
facets	<table border="0"> <tr> <td>Kind</td> <td>Value</td> </tr> <tr> <td>pattern</td> <td>[1-9]{1}[0-9]*</td> </tr> <tr> <td>enumeration</td> <td>1</td> </tr> <tr> <td>enumeration</td> <td>2</td> </tr> </table>	Kind	Value	pattern	[1-9]{1}[0-9]*	enumeration	1	enumeration	2
Kind	Value								
pattern	[1-9]{1}[0-9]*								
enumeration	1								
enumeration	2								

element **Spese\_Leasing\_Type/Canone**

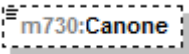
diagram					
namespace	urn:www.agenziaentrate.gov.it:specificheTecniche:sco:730				
type	restriction of <a href="#">DatoNP_Type</a>				
facets	<table border="0"> <tr> <td>Kind</td> <td>Value</td> </tr> <tr> <td>pattern</td> <td>[1-9]{1}[0-9]*</td> </tr> </table>	Kind	Value	pattern	[1-9]{1}[0-9]*
Kind	Value				
pattern	[1-9]{1}[0-9]*				

element **Spese\_Leasing\_Type/PrezzoRiscatto**

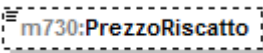
diagram					
namespace	urn:www.agenziaentrate.gov.it:specificheTecniche:sco:730				
type	restriction of <a href="#">DatoNP_Type</a>				
facets	<table border="0"> <tr> <td>Kind</td> <td>Value</td> </tr> <tr> <td>pattern</td> <td>[1-9]{1}[0-9]*</td> </tr> </table>	Kind	Value	pattern	[1-9]{1}[0-9]*
Kind	Value				
pattern	[1-9]{1}[0-9]*				

complexType **Spese\_Rateizzate\_Anni\_Precedenti\_Type**

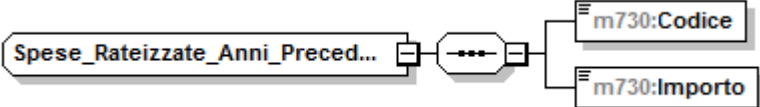
diagram	
---------	--

namespace	urn:www.agenziaentrate.gov.it:specificheTecniche:sco:730
children	<a href="#">m730:Codice</a> <a href="#">m730:Importo</a>

#### element **Spese\_Rateizzate\_Anni\_Precedenti\_Type/Codice**

diagram											
namespace	urn:www.agenziaentrate.gov.it:specificheTecniche:sco:730										
type	<a href="#">m730:Codice Spese Rateizzate Anni Precedenti Type</a>										
facets	<table border="1"> <tr> <td>Kind</td> <td>Value</td> </tr> <tr> <td>pattern</td> <td>[1-9]{1}[0-9]*</td> </tr> <tr> <td>enumeration</td> <td>2</td> </tr> <tr> <td>enumeration</td> <td>3</td> </tr> <tr> <td>enumeration</td> <td>4</td> </tr> </table>	Kind	Value	pattern	[1-9]{1}[0-9]*	enumeration	2	enumeration	3	enumeration	4
Kind	Value										
pattern	[1-9]{1}[0-9]*										
enumeration	2										
enumeration	3										
enumeration	4										

#### element **Spese\_Rateizzate\_Anni\_Precedenti\_Type/Importo**

diagram					
namespace	urn:www.agenziaentrate.gov.it:specificheTecniche:sco:730				
type	<a href="#">DatoNP Type</a>				
facets	<table border="1"> <tr> <td>Kind</td> <td>Value</td> </tr> <tr> <td>pattern</td> <td>[1-9]{1}[0-9]*</td> </tr> </table>	Kind	Value	pattern	[1-9]{1}[0-9]*
Kind	Value				
pattern	[1-9]{1}[0-9]*				

#### complexType **Spese\_Rateizzate\_Type**

diagram	
namespace	urn:www.agenziaentrate.gov.it:specificheTecniche:sco:730
children	<a href="#">m730:Codice</a> <a href="#">m730:Importo</a>

#### element **Spese\_Rateizzate\_Type/Codice**

diagram													
namespace	urn:www.agenziaentrate.gov.it:specificheTecniche:sco:730												
type	<a href="#">m730:Codice Spese Rateizzate Type</a>												
facets	<table border="1"> <tr> <td>Kind</td> <td>Value</td> </tr> <tr> <td>pattern</td> <td>[1-9]{1}[0-9]*</td> </tr> <tr> <td>enumeration</td> <td>1</td> </tr> <tr> <td>enumeration</td> <td>2</td> </tr> <tr> <td>enumeration</td> <td>3</td> </tr> <tr> <td>enumeration</td> <td>4</td> </tr> </table>	Kind	Value	pattern	[1-9]{1}[0-9]*	enumeration	1	enumeration	2	enumeration	3	enumeration	4
Kind	Value												
pattern	[1-9]{1}[0-9]*												
enumeration	1												
enumeration	2												
enumeration	3												
enumeration	4												



element **Spese\_Rateizzate\_Type/Importo**

diagram	
namespace	urn:www.agenziaentrate.gov.it:specificheTecniche:sco:730
type	<a href="#">DatoNP_Type</a>
facets	Kind Value pattern [1-9]{1}[0-9]*

complexType **Tassazione\_Separata\_Type**

diagram	
namespace	urn:www.agenziaentrate.gov.it:specificheTecniche:sco:730
children	<a href="#">m730:Opzione</a> <a href="#">m730:Anno</a> <a href="#">m730:RedditoRitenute</a>

element **Tassazione\_Separata\_Type/Opzione**

diagram	
namespace	urn:www.agenziaentrate.gov.it:specificheTecniche:sco:730
type	<a href="#">DatoCB_Type</a>
facets	Kind Value pattern [01]

element **Tassazione\_Separata\_Type/Anno**

diagram	
namespace	urn:www.agenziaentrate.gov.it:specificheTecniche:sco:730
type	<a href="#">DatoDA_Type</a>
facets	Kind Value pattern (18 19 20)[0-9]{2}

element **Tassazione\_Separata\_Type/RedditoRitenute**

diagram	
namespace	urn:www.agenziaentrate.gov.it:specificheTecniche:sco:730
type	<a href="#">m730:Redditi_Ritenute_Type</a>
children	<a href="#">m730:ImportoRedditi</a> <a href="#">m730:ImportoRitenute</a>

complexType **Terreno\_Type**

diagram	
namespace	urn:www.agenziaentrate.gov.it:specificheTecniche:sco:730
children	<a href="#">m730:RedDominicale</a> <a href="#">m730:Titolo</a> <a href="#">m730:RedAgrario</a> <a href="#">m730:GiorniPossesso</a> <a href="#">m730:PercPossesso</a> <a href="#">m730:CanoneVincolistico</a> <a href="#">m730:CasiParticolari</a> <a href="#">m730:CasellaContinuazione</a> <a href="#">m730:CasellalmuNonDovuta</a> <a href="#">m730:CasellaColtivatoreDiretto</a>

element **Terreno\_Type/RedDominicale**

diagram	
namespace	urn:www.agenziaentrate.gov.it:specificheTecniche:sco:730
type	<a href="#">DatoNP_Type</a>
facets	Kind Value

pattern	[1-9]{1}[0-9]*
---------	----------------

### element Terreno\_Type/Titolo

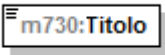
diagram																					
namespace	urn:www.agenziaentrate.gov.it:specificheTecniche:sco:730																				
type	<a href="#">m730:Titolo Terreno Type</a>																				
facets	<table border="1"> <thead> <tr> <th>Kind</th> <th>Value</th> </tr> </thead> <tbody> <tr> <td>pattern</td> <td>[1-9]{1}[0-9]*</td> </tr> <tr> <td>enumeration</td> <td>1</td> </tr> <tr> <td>enumeration</td> <td>2</td> </tr> <tr> <td>enumeration</td> <td>3</td> </tr> <tr> <td>enumeration</td> <td>4</td> </tr> <tr> <td>enumeration</td> <td>5</td> </tr> <tr> <td>enumeration</td> <td>6</td> </tr> <tr> <td>enumeration</td> <td>7</td> </tr> <tr> <td>enumeration</td> <td>10</td> </tr> </tbody> </table>	Kind	Value	pattern	[1-9]{1}[0-9]*	enumeration	1	enumeration	2	enumeration	3	enumeration	4	enumeration	5	enumeration	6	enumeration	7	enumeration	10
Kind	Value																				
pattern	[1-9]{1}[0-9]*																				
enumeration	1																				
enumeration	2																				
enumeration	3																				
enumeration	4																				
enumeration	5																				
enumeration	6																				
enumeration	7																				
enumeration	10																				

### element Terreno\_Type/RedAgrario

diagram					
namespace	urn:www.agenziaentrate.gov.it:specificheTecniche:sco:730				
type	<a href="#">DatoNP Type</a>				
facets	<table border="1"> <thead> <tr> <th>Kind</th> <th>Value</th> </tr> </thead> <tbody> <tr> <td>pattern</td> <td>[1-9]{1}[0-9]*</td> </tr> </tbody> </table>	Kind	Value	pattern	[1-9]{1}[0-9]*
Kind	Value				
pattern	[1-9]{1}[0-9]*				

### element Terreno\_Type/GiorniPossesso

diagram					
namespace	urn:www.agenziaentrate.gov.it:specificheTecniche:sco:730				
type	<a href="#">DatoGA Type</a>				
facets	<table border="1"> <thead> <tr> <th>Kind</th> <th>Value</th> </tr> </thead> <tbody> <tr> <td>pattern</td> <td>[1-9](((1-9)[0-9]) ((12)[0-9][0-9]) (3[0-5][0-9]) (36[0-5]))</td> </tr> </tbody> </table>	Kind	Value	pattern	[1-9](((1-9)[0-9]) ((12)[0-9][0-9]) (3[0-5][0-9]) (36[0-5]))
Kind	Value				
pattern	[1-9](((1-9)[0-9]) ((12)[0-9][0-9]) (3[0-5][0-9]) (36[0-5]))				

### element Terreno\_Type/PercPossesso

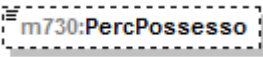
diagram					
namespace	urn:www.agenziaentrate.gov.it:specificheTecniche:sco:730				
type	<a href="#">DatoPC Type</a>				
facets	<table border="1"> <thead> <tr> <th>Kind</th> <th>Value</th> </tr> </thead> <tbody> <tr> <td>pattern</td> <td>[0-9]?[0-9](,\\d{1,3})? 100,(0{1,3})?</td> </tr> </tbody> </table>	Kind	Value	pattern	[0-9]?[0-9](,\\d{1,3})? 100,(0{1,3})?
Kind	Value				
pattern	[0-9]?[0-9](,\\d{1,3})? 100,(0{1,3})?				

**element Terreno\_Type/CanoneVincolistico**

diagram	 <b>m730:CanoneVincolistico</b>				
namespace	urn:www.agenziaentrate.gov.it:specificheTecniche:sco:730				
type	<a href="#">DatoNP_Type</a>				
facets	<table border="1"> <thead> <tr> <th>Kind</th> <th>Value</th> </tr> </thead> <tbody> <tr> <td>pattern</td> <td>[1-9]{1}[0-9]*</td> </tr> </tbody> </table>	Kind	Value	pattern	[1-9]{1}[0-9]*
Kind	Value				
pattern	[1-9]{1}[0-9]*				

**element Terreno\_Type/CasiParticolari**

diagram	 <b>m730:CasiParticolari</b>												
namespace	urn:www.agenziaentrate.gov.it:specificheTecniche:sco:730												
type	<a href="#">m730:Casi_Particolari_Terreni_Type</a>												
facets	<table border="1"> <thead> <tr> <th>Kind</th> <th>Value</th> </tr> </thead> <tbody> <tr> <td>pattern</td> <td>[1-9]</td> </tr> <tr> <td>enumeration</td> <td>2</td> </tr> <tr> <td>enumeration</td> <td>3</td> </tr> <tr> <td>enumeration</td> <td>4</td> </tr> <tr> <td>enumeration</td> <td>6</td> </tr> </tbody> </table>	Kind	Value	pattern	[1-9]	enumeration	2	enumeration	3	enumeration	4	enumeration	6
Kind	Value												
pattern	[1-9]												
enumeration	2												
enumeration	3												
enumeration	4												
enumeration	6												

**element Terreno\_Type/CasellaContinuazione**

diagram	 <b>m730:CasellaContinuazione</b>				
namespace	urn:www.agenziaentrate.gov.it:specificheTecniche:sco:730				
type	<a href="#">DatoCB_Type</a>				
facets	<table border="1"> <thead> <tr> <th>Kind</th> <th>Value</th> </tr> </thead> <tbody> <tr> <td>pattern</td> <td>[01]</td> </tr> </tbody> </table>	Kind	Value	pattern	[01]
Kind	Value				
pattern	[01]				

**element Terreno\_Type/CasellalmuNonDovuta**

diagram	 <b>m730:CasellalmuNonDovuta</b>				
namespace	urn:www.agenziaentrate.gov.it:specificheTecniche:sco:730				
type	<a href="#">DatoCB_Type</a>				
facets	<table border="1"> <thead> <tr> <th>Kind</th> <th>Value</th> </tr> </thead> <tbody> <tr> <td>pattern</td> <td>[01]</td> </tr> </tbody> </table>	Kind	Value	pattern	[01]
Kind	Value				
pattern	[01]				

**element Terreno\_Type/CasellaColtivatoreDiretto**

diagram	 <b>m730:CasellaColtivatoreDiretto</b>
namespace	urn:www.agenziaentrate.gov.it:specificheTecniche:sco:730
type	<a href="#">DatoCB_Type</a>

facets	Kind pattern	Value [01]
--------	--------------	------------

complexType **Versamenti\_F24\_Type**

<p>diagram</p>	
<p>namespace</p>	<p>urn:www.agenziaentrate.gov.it:specificheTecniche:sco:730</p>
<p>children</p>	<p><a href="#">m730:F24DebitoIrpef</a> <a href="#">m730:F24DebitoCodRegione</a> <a href="#">m730:F24DebitoAddReg</a> <a href="#">m730:F24DebitoCodComune</a> <a href="#">m730:F24DebitoAddCom</a> <a href="#">m730:F24DebitoPrimaRataAcclrpef</a> <a href="#">m730:F24DebitoAccontoTassSep</a> <a href="#">m730:F24DebitoCodComuneAcconto</a> <a href="#">m730:F24DebitoAccontoAddCom</a> <a href="#">m730:F24DebitoImpostaSost</a> <a href="#">m730:F24DebitoCedolare</a> <a href="#">m730:F24DebitoPrimaRataAccCedolare</a> <a href="#">m730:F24DebitoCodRegioneConiuge</a> <a href="#">m730:F24DebitoAddRegConiuge</a> <a href="#">m730:F24DebitoCodComuneConiuge</a> <a href="#">m730:F24DebitoAddComConiuge</a> <a href="#">m730:F24DebitoCodComuneAcc...</a> <a href="#">m730:F24DebitoAccontoAddCo...</a> <a href="#">m730:F24Debito SecondaRataAcc...</a> <a href="#">m730:F24Debito SecondaRataAcc...</a></p>

	<a href="#">m730:F24DebitoCodComuneAccontoConiuge</a> <a href="#">m730:F24DebitoAccontoAddComConiuge</a> <a href="#">m730:F24DebitoSecondaRataAcclrpef</a> <a href="#">m730:F24DebitoSecondaRataAccCedolare</a>
--	--

element **Versamenti\_F24\_Type/F24Debitolrpef**

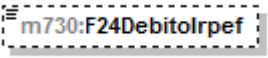
diagram					
namespace	urn:www.agenziaentrate.gov.it:specificheTecniche:sco:730				
type	<a href="#">DatoNP_Type</a>				
facets	<table border="1"> <thead> <tr> <th>Kind</th> <th>Value</th> </tr> </thead> <tbody> <tr> <td>pattern</td> <td>[1-9]{1}[0-9]*</td> </tr> </tbody> </table>	Kind	Value	pattern	[1-9]{1}[0-9]*
Kind	Value				
pattern	[1-9]{1}[0-9]*				

element **Versamenti\_F24\_Type/F24DebitoCodRegione**

diagram																																															
namespace	urn:www.agenziaentrate.gov.it:specificheTecniche:sco:730																																														
type	<a href="#">Codice_Regione_Type</a>																																														
facets	<table border="1"> <thead> <tr> <th>Kind</th> <th>Value</th> </tr> </thead> <tbody> <tr> <td>pattern</td> <td>([0-9A-Z-] \&amp;quot;){1}([ 0-9A-Z&amp;amp;] " - \., / \^\(\ \)\À È É Ì Ò Ù Ü \&amp;quot; \ \\ +)*</td> </tr> <tr><td>enumeration</td><td>1</td></tr> <tr><td>enumeration</td><td>2</td></tr> <tr><td>enumeration</td><td>3</td></tr> <tr><td>enumeration</td><td>4</td></tr> <tr><td>enumeration</td><td>5</td></tr> <tr><td>enumeration</td><td>6</td></tr> <tr><td>enumeration</td><td>7</td></tr> <tr><td>enumeration</td><td>8</td></tr> <tr><td>enumeration</td><td>9</td></tr> <tr><td>enumeration</td><td>10</td></tr> <tr><td>enumeration</td><td>11</td></tr> <tr><td>enumeration</td><td>12</td></tr> <tr><td>enumeration</td><td>13</td></tr> <tr><td>enumeration</td><td>14</td></tr> <tr><td>enumeration</td><td>15</td></tr> <tr><td>enumeration</td><td>16</td></tr> <tr><td>enumeration</td><td>17</td></tr> <tr><td>enumeration</td><td>18</td></tr> <tr><td>enumeration</td><td>19</td></tr> <tr><td>enumeration</td><td>20</td></tr> <tr><td>enumeration</td><td>21</td></tr> </tbody> </table>	Kind	Value	pattern	([0-9A-Z-] \&quot;){1}([ 0-9A-Z&amp;] " - \., / \^\(\ \)\À È É Ì Ò Ù Ü \&quot; \ \\ +)*	enumeration	1	enumeration	2	enumeration	3	enumeration	4	enumeration	5	enumeration	6	enumeration	7	enumeration	8	enumeration	9	enumeration	10	enumeration	11	enumeration	12	enumeration	13	enumeration	14	enumeration	15	enumeration	16	enumeration	17	enumeration	18	enumeration	19	enumeration	20	enumeration	21
Kind	Value																																														
pattern	([0-9A-Z-] \&quot;){1}([ 0-9A-Z&amp;] " - \., / \^\(\ \)\À È É Ì Ò Ù Ü \&quot; \ \\ +)*																																														
enumeration	1																																														
enumeration	2																																														
enumeration	3																																														
enumeration	4																																														
enumeration	5																																														
enumeration	6																																														
enumeration	7																																														
enumeration	8																																														
enumeration	9																																														
enumeration	10																																														
enumeration	11																																														
enumeration	12																																														
enumeration	13																																														
enumeration	14																																														
enumeration	15																																														
enumeration	16																																														
enumeration	17																																														
enumeration	18																																														
enumeration	19																																														
enumeration	20																																														
enumeration	21																																														

element **Versamenti\_F24\_Type/F24DebitoAddReg**

diagram					
namespace	urn:www.agenziaentrate.gov.it:specificheTecniche:sco:730				
type	<a href="#">DatoNP_Type</a>				
facets	<table border="1"> <thead> <tr> <th>Kind</th> <th>Value</th> </tr> </thead> <tbody> <tr> <td>pattern</td> <td>[1-9]{1}[0-9]*</td> </tr> </tbody> </table>	Kind	Value	pattern	[1-9]{1}[0-9]*
Kind	Value				
pattern	[1-9]{1}[0-9]*				

element **Versamenti\_F24\_Type/F24DebitoCodComune**

diagram	 m730:F24DebitoCodComune
namespace	urn:www.agenziaentrate.gov.it:specificheTecniche:sco:730
type	<a href="#">DatoAN_Type</a>
facets	Kind Value pattern ([0-9A-Z\-\-]&quot;){1}([ 0-9A-Z&amp;:] \- \., / \^\(\ \)\À È É Ì Ò Ù Ü &quot; \ \ \ /+)*

element **Versamenti\_F24\_Type/F24DebitoAddCom**

diagram	 m730:F24DebitoAddCom
namespace	urn:www.agenziaentrate.gov.it:specificheTecniche:sco:730
type	<a href="#">DatoNP_Type</a>
facets	Kind Value pattern [1-9]{1}[0-9]*

element **Versamenti\_F24\_Type/F24DebitoPrimaRataAcclrpef**

diagram	 m730:F24DebitoPrimaRataAcclrpef
namespace	urn:www.agenziaentrate.gov.it:specificheTecniche:sco:730
type	<a href="#">DatoNP_Type</a>
facets	Kind Value pattern [1-9]{1}[0-9]*

element **Versamenti\_F24\_Type/F24DebitoAccontoTassSep**

diagram	 m730:F24DebitoAccontoTass Sep
namespace	urn:www.agenziaentrate.gov.it:specificheTecniche:sco:730
type	<a href="#">DatoNP_Type</a>
facets	Kind Value pattern [1-9]{1}[0-9]*

element **Versamenti\_F24\_Type/F24DebitoCodComuneAcconto**

diagram	 m730:F24DebitoCodComuneAcc...
namespace	urn:www.agenziaentrate.gov.it:specificheTecniche:sco:730
type	<a href="#">DatoAN_Type</a>
facets	Kind Value pattern ([0-9A-Z\-\-]&quot;){1}([ 0-9A-Z&amp;:] \- \., / \^\(\ \)\À È É Ì Ò Ù Ü &quot; \ \ \ /+)*

element **Versamenti\_F24\_Type/F24DebitoAccontoAddCom**

diagram	 m730:F24DebitoAccontoAddCom				
namespace	urn:www.agenziaentrate.gov.it:specificheTecniche:sco:730				
type	<a href="#">DatoNP_Type</a>				
facets	<table border="1"> <tr> <td>Kind</td> <td>Value</td> </tr> <tr> <td>pattern</td> <td>[1-9]{1}[0-9]*</td> </tr> </table>	Kind	Value	pattern	[1-9]{1}[0-9]*
Kind	Value				
pattern	[1-9]{1}[0-9]*				

element **Versamenti\_F24\_Type/F24DebitoImpostaSost**

diagram	 m730:F24DebitoImpostaSost				
namespace	urn:www.agenziaentrate.gov.it:specificheTecniche:sco:730				
type	<a href="#">DatoNP_Type</a>				
facets	<table border="1"> <tr> <td>Kind</td> <td>Value</td> </tr> <tr> <td>pattern</td> <td>[1-9]{1}[0-9]*</td> </tr> </table>	Kind	Value	pattern	[1-9]{1}[0-9]*
Kind	Value				
pattern	[1-9]{1}[0-9]*				

element **Versamenti\_F24\_Type/F24DebitoCedolare**

diagram	 m730:F24DebitoCedolare				
namespace	urn:www.agenziaentrate.gov.it:specificheTecniche:sco:730				
type	<a href="#">DatoNP_Type</a>				
facets	<table border="1"> <tr> <td>Kind</td> <td>Value</td> </tr> <tr> <td>pattern</td> <td>[1-9]{1}[0-9]*</td> </tr> </table>	Kind	Value	pattern	[1-9]{1}[0-9]*
Kind	Value				
pattern	[1-9]{1}[0-9]*				

element **Versamenti\_F24\_Type/F24DebitoPrimaRataAccCedolare**

diagram	 m730:F24DebitoPrimaRataAccCe...				
namespace	urn:www.agenziaentrate.gov.it:specificheTecniche:sco:730				
type	<a href="#">DatoNP_Type</a>				
facets	<table border="1"> <tr> <td>Kind</td> <td>Value</td> </tr> <tr> <td>pattern</td> <td>[1-9]{1}[0-9]*</td> </tr> </table>	Kind	Value	pattern	[1-9]{1}[0-9]*
Kind	Value				
pattern	[1-9]{1}[0-9]*				

element **Versamenti\_F24\_Type/F24DebitoCodRegioneConiuge**

diagram	 m730:F24DebitoCodRegioneConi...				
namespace	urn:www.agenziaentrate.gov.it:specificheTecniche:sco:730				
type	<a href="#">Codice_Regione_Type</a>				
facets	<table border="1"> <tr> <td>Kind</td> <td>Value</td> </tr> <tr> <td>pattern</td> <td>(([0-9A-Z-] &amp;quot;){1}([ 0-9A-Z&amp;amp;] ' \" data-bbox="195 855 750 877"&gt; </td></tr> </table>	Kind	Value	pattern	(([0-9A-Z-] &quot;){1}([ 0-9A-Z&amp;] ' \" data-bbox="195 855 750 877">
Kind	Value				
pattern	(([0-9A-Z-] &quot;){1}([ 0-9A-Z&amp;] ' \" data-bbox="195 855 750 877">				



enumeration	1
enumeration	2
enumeration	3
enumeration	4
enumeration	5
enumeration	6
enumeration	7
enumeration	8
enumeration	9
enumeration	10
enumeration	11
enumeration	12
enumeration	13
enumeration	14
enumeration	15
enumeration	16
enumeration	17
enumeration	18
enumeration	19
enumeration	20
enumeration	21

**element Versamenti\_F24\_Type/F24DebitoAddRegConiuge**

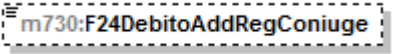
diagram					
namespace	urn:www.agenziaentrate.gov.it:specificheTecniche:sco:730				
type	<a href="#">DatoNP_Type</a>				
facets	<table border="1"> <thead> <tr> <th>Kind</th> <th>Value</th> </tr> </thead> <tbody> <tr> <td>pattern</td> <td>[1-9]{1}[0-9]*</td> </tr> </tbody> </table>	Kind	Value	pattern	[1-9]{1}[0-9]*
Kind	Value				
pattern	[1-9]{1}[0-9]*				

**element Versamenti\_F24\_Type/F24DebitoCodComuneConiuge**

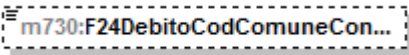
diagram					
namespace	urn:www.agenziaentrate.gov.it:specificheTecniche:sco:730				
type	<a href="#">DatoAN_Type</a>				
facets	<table border="1"> <thead> <tr> <th>Kind</th> <th>Value</th> </tr> </thead> <tbody> <tr> <td>pattern</td> <td>([0-9A-Z\-\ ]&amp;quot;){1}([ 0-9A-Z&amp;amp;:] ' - \. / ° ^\(\ )\ À É È Ì Ò Ù Û &amp;quot; \N \+)*</td> </tr> </tbody> </table>	Kind	Value	pattern	([0-9A-Z\-\ ]&quot;){1}([ 0-9A-Z&amp;:] ' - \. / ° ^\(\ )\ À É È Ì Ò Ù Û &quot; \N \+)*
Kind	Value				
pattern	([0-9A-Z\-\ ]&quot;){1}([ 0-9A-Z&amp;:] ' - \. / ° ^\(\ )\ À É È Ì Ò Ù Û &quot; \N \+)*				

**element Versamenti\_F24\_Type/F24DebitoAddComConiuge**

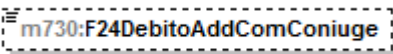
diagram					
namespace	urn:www.agenziaentrate.gov.it:specificheTecniche:sco:730				
type	<a href="#">DatoNP_Type</a>				
facets	<table border="1"> <thead> <tr> <th>Kind</th> <th>Value</th> </tr> </thead> <tbody> <tr> <td>pattern</td> <td>[1-9]{1}[0-9]*</td> </tr> </tbody> </table>	Kind	Value	pattern	[1-9]{1}[0-9]*
Kind	Value				
pattern	[1-9]{1}[0-9]*				

element **Versamenti\_F24\_Type/F24DebitoCodComuneAccontoConiuge**

diagram					
namespace	urn:www.agenziaentrate.gov.it:specificheTecniche:sco:730				
type	<a href="#">DatoAN_Type</a>				
facets	<table border="1"> <tr> <td>Kind</td> <td>Value</td> </tr> <tr> <td>pattern</td> <td>(([0-9A-Z-] \&amp;quot;){1}([ 0-9A-Z&amp;amp;:] \- \., / \^\(\ \)\À È É Ì Ò Ù Ü &amp;quot; \N \ +)*</td> </tr> </table>	Kind	Value	pattern	(([0-9A-Z-] \&quot;){1}([ 0-9A-Z&amp;:] \- \., / \^\(\ \)\À È É Ì Ò Ù Ü &quot; \N \ +)*
Kind	Value				
pattern	(([0-9A-Z-] \&quot;){1}([ 0-9A-Z&amp;:] \- \., / \^\(\ \)\À È É Ì Ò Ù Ü &quot; \N \ +)*				

element **Versamenti\_F24\_Type/F24DebitoAccontoAddComConiuge**

diagram					
namespace	urn:www.agenziaentrate.gov.it:specificheTecniche:sco:730				
type	<a href="#">DatoNP_Type</a>				
facets	<table border="1"> <tr> <td>Kind</td> <td>Value</td> </tr> <tr> <td>pattern</td> <td>[1-9]{1}[0-9]*</td> </tr> </table>	Kind	Value	pattern	[1-9]{1}[0-9]*
Kind	Value				
pattern	[1-9]{1}[0-9]*				

element **Versamenti\_F24\_Type/F24DebitoSecondaRataAcclrpef**

diagram					
namespace	urn:www.agenziaentrate.gov.it:specificheTecniche:sco:730				
type	<a href="#">DatoNP_Type</a>				
facets	<table border="1"> <tr> <td>Kind</td> <td>Value</td> </tr> <tr> <td>pattern</td> <td>[1-9]{1}[0-9]*</td> </tr> </table>	Kind	Value	pattern	[1-9]{1}[0-9]*
Kind	Value				
pattern	[1-9]{1}[0-9]*				

element **Versamenti\_F24\_Type/F24DebitoSecondaRataAccCedolare**

diagram					
namespace	urn:www.agenziaentrate.gov.it:specificheTecniche:sco:730				
type	<a href="#">DatoNP_Type</a>				
facets	<table border="1"> <tr> <td>Kind</td> <td>Value</td> </tr> <tr> <td>pattern</td> <td>[1-9]{1}[0-9]*</td> </tr> </table>	Kind	Value	pattern	[1-9]{1}[0-9]*
Kind	Value				
pattern	[1-9]{1}[0-9]*				

element **Documento**

diagram	<pre> classDiagram     class Documento     class Documento_Type {         attributes         identificativo     }     Documento "1" *-- "1" Documento_Type     </pre>
---------	---

namespace	urn:www.agenziaentrate.gov.it:specificheTecniche:common				
type	<a href="#">Documento_Type</a>				
attributes	Name <a href="#">identificativo</a>	Type <a href="#">Identificativo_Type</a>	Use required	Default	Fixed

### complexType Documento\_Type

diagram					
namespace	urn:www.agenziaentrate.gov.it:specificheTecniche:common				
attributes	Name <a href="#">identificativo</a>	Type <a href="#">Identificativo_Type</a>	Use required	Default	Fixed

### attribute Documento\_Type/@identificativo

type	<a href="#">Identificativo_Type</a>				
facets	Kind	Value			
	pattern	[0-9]{4}[1-9][0-9]{3}[1-9][0-9][0-9]{2}[1-9][0-9]{2}[0-9][1-9][0-9]{3}[1-9][0-9]{4}			

### simpleType Identificativo\_Type

namespace	urn:www.agenziaentrate.gov.it:specificheTecniche:common				
type	restriction of <b>xs:string</b>				
facets	Kind	Value			
	pattern	[0-9]{4}[1-9][0-9]{3}[1-9][0-9][0-9]{2}[1-9][0-9]{2}[0-9][1-9][0-9]{3}[1-9][0-9]{4}			

### simpleType Anno\_Anticipazione\_Fondo\_Pensione\_Type

namespace	urn:www.agenziaentrate.gov.it:specificheTecniche:sco:730				
type	restriction of <a href="#">DatoNP_Type</a>				
facets	Kind	Value			
	pattern	[1-9]{1}[0-9]*			
	enumeration	2007			
	enumeration	2008			
	enumeration	2009			
	enumeration	2010			
	enumeration	2011			
	enumeration	2012			
	enumeration	2013			
	enumeration	2014			
	enumeration	2015			
	enumeration	2016			
	enumeration	2017			

### simpleType Anno\_Recupero\_Patrimonio\_Edilizio\_Type

namespace	urn:www.agenziaentrate.gov.it:specificheTecniche:sco:730				
-----------	--	--	--	--	--

type	restriction of <a href="#">DatoNP_Type</a>																								
facets	<table border="1"> <thead> <tr> <th>Kind</th> <th>Value</th> </tr> </thead> <tbody> <tr> <td>pattern</td> <td>[1-9]{1}[0-9]*</td> </tr> <tr> <td>enumeration</td> <td>2008</td> </tr> <tr> <td>enumeration</td> <td>2009</td> </tr> <tr> <td>enumeration</td> <td>2010</td> </tr> <tr> <td>enumeration</td> <td>2011</td> </tr> <tr> <td>enumeration</td> <td>2012</td> </tr> <tr> <td>enumeration</td> <td>2013</td> </tr> <tr> <td>enumeration</td> <td>2014</td> </tr> <tr> <td>enumeration</td> <td>2015</td> </tr> <tr> <td>enumeration</td> <td>2016</td> </tr> <tr> <td>enumeration</td> <td>2017</td> </tr> </tbody> </table>	Kind	Value	pattern	[1-9]{1}[0-9]*	enumeration	2008	enumeration	2009	enumeration	2010	enumeration	2011	enumeration	2012	enumeration	2013	enumeration	2014	enumeration	2015	enumeration	2016	enumeration	2017
Kind	Value																								
pattern	[1-9]{1}[0-9]*																								
enumeration	2008																								
enumeration	2009																								
enumeration	2010																								
enumeration	2011																								
enumeration	2012																								
enumeration	2013																								
enumeration	2014																								
enumeration	2015																								
enumeration	2016																								
enumeration	2017																								

### simpleType Anno\_Risparmio\_Energetico\_Type

namespace	urn:www.agenziaentrate.gov.it:specificheTecniche:sco:730																				
type	restriction of <a href="#">DatoNP_Type</a>																				
facets	<table border="1"> <thead> <tr> <th>Kind</th> <th>Value</th> </tr> </thead> <tbody> <tr> <td>pattern</td> <td>[1-9]{1}[0-9]*</td> </tr> <tr> <td>enumeration</td> <td>2008</td> </tr> <tr> <td>enumeration</td> <td>2011</td> </tr> <tr> <td>enumeration</td> <td>2012</td> </tr> <tr> <td>enumeration</td> <td>2013</td> </tr> <tr> <td>enumeration</td> <td>2014</td> </tr> <tr> <td>enumeration</td> <td>2015</td> </tr> <tr> <td>enumeration</td> <td>2016</td> </tr> <tr> <td>enumeration</td> <td>2017</td> </tr> </tbody> </table>	Kind	Value	pattern	[1-9]{1}[0-9]*	enumeration	2008	enumeration	2011	enumeration	2012	enumeration	2013	enumeration	2014	enumeration	2015	enumeration	2016	enumeration	2017
Kind	Value																				
pattern	[1-9]{1}[0-9]*																				
enumeration	2008																				
enumeration	2011																				
enumeration	2012																				
enumeration	2013																				
enumeration	2014																				
enumeration	2015																				
enumeration	2016																				
enumeration	2017																				

### simpleType Casi\_Particolari\_Fabbricato\_Type

namespace	urn:www.agenziaentrate.gov.it:specificheTecniche:sco:730												
type	restriction of <a href="#">DatoN1_Type</a>												
facets	<table border="1"> <thead> <tr> <th>Kind</th> <th>Value</th> </tr> </thead> <tbody> <tr> <td>pattern</td> <td>[1-9]</td> </tr> <tr> <td>enumeration</td> <td>1</td> </tr> <tr> <td>enumeration</td> <td>3</td> </tr> <tr> <td>enumeration</td> <td>4</td> </tr> <tr> <td>enumeration</td> <td>5</td> </tr> </tbody> </table>	Kind	Value	pattern	[1-9]	enumeration	1	enumeration	3	enumeration	4	enumeration	5
Kind	Value												
pattern	[1-9]												
enumeration	1												
enumeration	3												
enumeration	4												
enumeration	5												

### simpleType Casi\_Particolari\_Risp\_Ener\_Type

namespace	urn:www.agenziaentrate.gov.it:specificheTecniche:sco:730										
type	restriction of <a href="#">DatoN1_Type</a>										
facets	<table border="1"> <thead> <tr> <th>Kind</th> <th>Value</th> </tr> </thead> <tbody> <tr> <td>pattern</td> <td>[1-9]</td> </tr> <tr> <td>enumeration</td> <td>1</td> </tr> <tr> <td>enumeration</td> <td>2</td> </tr> <tr> <td>enumeration</td> <td>3</td> </tr> </tbody> </table>	Kind	Value	pattern	[1-9]	enumeration	1	enumeration	2	enumeration	3
Kind	Value										
pattern	[1-9]										
enumeration	1										
enumeration	2										
enumeration	3										

### simpleType Casi\_Particolari\_Terreni\_Type

namespace	urn:www.agenziaentrate.gov.it:specificheTecniche:sco:730
type	restriction of <a href="#">DatoN1_Type</a>

facets	Kind	Value
	pattern	[1-9]
	enumeration	2
	enumeration	3
	enumeration	4
	enumeration	6

### simpleType **Codice\_Altre\_Detrazioni\_Type**

namespace	urn:www.agenziaentrate.gov.it:specificheTecniche:sco:730	
type	restriction of <a href="#">DatoNP_Type</a>	
facets	Kind	Value
	pattern	[1-9]{1}[0-9]*
	enumeration	1
	enumeration	2

### simpleType **Codice\_Altre\_Spese\_Type**

namespace	urn:www.agenziaentrate.gov.it:specificheTecniche:sco:730	
type	restriction of <a href="#">DatoNP_Type</a>	
facets	Kind	Value
	pattern	[1-9]{1}[0-9]*
	enumeration	8
	enumeration	9
	enumeration	10
	enumeration	11
	enumeration	12
	enumeration	13
	enumeration	14
	enumeration	15
	enumeration	16
	enumeration	17
	enumeration	18
	enumeration	20
	enumeration	21
	enumeration	22
	enumeration	23
	enumeration	24
	enumeration	25
	enumeration	26
	enumeration	27
	enumeration	28
	enumeration	29
	enumeration	30
	enumeration	31
	enumeration	32
	enumeration	33
	enumeration	35
	enumeration	36
enumeration	38	
enumeration	39	
enumeration	41	
enumeration	42	
enumeration	99	

### simpleType **Codice\_Altri\_Oneri\_Type**

namespace	urn:www.agenziaentrate.gov.it:specificheTecniche:sco:730	
type	restriction of <a href="#">DatoNP_Type</a>	

facets	Kind	Value
	pattern	[1-9]{1}[0-9]*
	enumeration	6
	enumeration	7
	enumeration	8
	enumeration	9
	enumeration	12
	enumeration	13
enumeration	21	

### simpleType **Codice\_Canone\_Type**

namespace	urn:www.agenziaentrate.gov.it:specificheTecniche:sco:730	
type	restriction of <a href="#">DatoN1_Type</a>	
facets	Kind	Value
	pattern	[1-9]
	enumeration	1
	enumeration	2
	enumeration	3
	enumeration	4

### simpleType **Codice\_Evento\_Eccezionale\_Type**

namespace	urn:www.agenziaentrate.gov.it:specificheTecniche:sco:730	
type	restriction of <a href="#">DatoNP_Type</a>	
facets	Kind	Value
	pattern	[1-9]{1}[0-9]*
	enumeration	1
	enumeration	2
	enumeration	3
	enumeration	4
	enumeration	5
	enumeration	6
	enumeration	7
enumeration	8	

### simpleType **Codice\_Spese\_Rateizzate\_Anni\_Precedenti\_Type**

namespace	urn:www.agenziaentrate.gov.it:specificheTecniche:sco:730	
type	restriction of <a href="#">DatoNP_Type</a>	
facets	Kind	Value
	pattern	[1-9]{1}[0-9]*
	enumeration	2
	enumeration	3
	enumeration	4

### simpleType **Codice\_Spese\_Rateizzate\_Type**

namespace	urn:www.agenziaentrate.gov.it:specificheTecniche:sco:730	
type	restriction of <a href="#">DatoNP_Type</a>	
facets	Kind	Value
	pattern	[1-9]{1}[0-9]*
	enumeration	1
	enumeration	2
	enumeration	3
enumeration	4	

### simpleType **Fabbricato\_Agev\_Numero\_Rigo\_Type**

namespace	urn:www.agenziaentrate.gov.it:specificheTecniche:sco:730	
type	restriction of <a href="#">DatoNP_Type</a>	
facets	Kind	Value
	pattern	[1-9]{1}[0-9]*
	enumeration	1
	enumeration	2
	enumeration	3
	enumeration	4
	enumeration	5
	enumeration	6
	enumeration	7
	enumeration	8
	enumeration	9
	enumeration	10

### simpleType **Indeterminato\_Determinato\_Type**

namespace	urn:www.agenziaentrate.gov.it:specificheTecniche:sco:730	
type	restriction of <a href="#">DatoN1_Type</a>	
facets	Kind	Value
	pattern	[1-9]
	enumeration	1
	enumeration	2

### simpleType **Integrativo\_Type**

namespace	urn:www.agenziaentrate.gov.it:specificheTecniche:sco:730	
type	restriction of <a href="#">DatoN1_Type</a>	
facets	Kind	Value
	pattern	[1-9]
	enumeration	1
	enumeration	2
	enumeration	3

### simpleType **Mesi\_Type**

namespace	urn:www.agenziaentrate.gov.it:specificheTecniche:sco:730	
type	restriction of <a href="#">DatoNP_Type</a>	
facets	Kind	Value
	pattern	[1-9]{1}[0-9]*
	enumeration	1
	enumeration	2
	enumeration	3
	enumeration	4
	enumeration	5
	enumeration	6
	enumeration	7
	enumeration	8
	enumeration	9
	enumeration	10
	enumeration	11
	enumeration	12

### simpleType Numero\_Rata\_Risparmio\_Energetico\_Type

namespace	urn:www.agenziaentrate.gov.it:specificheTecniche:sco:730	
type	restriction of <a href="#">DatoNP_Type</a>	
facets	Kind	Value
	pattern	[1-9]{1}[0-9]*
	enumeration	1
	enumeration	2
	enumeration	3
	enumeration	4
	enumeration	5
	enumeration	6
	enumeration	7
	enumeration	10

### simpleType Periodo\_Spese\_Ristrutturazione\_Type

namespace	urn:www.agenziaentrate.gov.it:specificheTecniche:sco:730	
type	restriction of <a href="#">DatoNP_Type</a>	
facets	Kind	Value
	pattern	[1-9]{1}[0-9]*
	enumeration	2
	enumeration	3
	enumeration	4
	enumeration	5
	enumeration	6
	enumeration	7
	enumeration	8
	enumeration	9
	enumeration	10
	enumeration	11

### simpleType Rate10\_Type

namespace	urn:www.agenziaentrate.gov.it:specificheTecniche:sco:730	
type	restriction of <a href="#">DatoNP_Type</a>	
facets	Kind	Value
	pattern	[1-9]{1}[0-9]*
	enumeration	1
	enumeration	2
	enumeration	3
	enumeration	4
	enumeration	5
	enumeration	6
	enumeration	7
	enumeration	8
	enumeration	9
	enumeration	10

### simpleType Rate\_Risparmio\_Energetico\_Type

namespace	urn:www.agenziaentrate.gov.it:specificheTecniche:sco:730	
type	restriction of <a href="#">DatoNP_Type</a>	
facets	Kind	Value
	pattern	[1-9]{1}[0-9]*



	enumeration	4
	enumeration	5
	enumeration	6
	enumeration	7
	enumeration	8
	enumeration	9
	enumeration	10

### simpleType Reintegro\_Totale\_Parziale\_Type

namespace	urn:www.agenziaentrate.gov.it:specificheTecniche:sco:730	
type	restriction of <a href="#">DatoN1_Type</a>	
facets	Kind	Value
	pattern	[1-9]
	enumeration	1
	enumeration	2

### simpleType Rettificativo\_Type

namespace	urn:www.agenziaentrate.gov.it:specificheTecniche:sco:730	
type	restriction of <a href="#">DatoN1_Type</a>	
facets	Kind	Value
	pattern	[1-9]
	enumeration	1
	enumeration	2
	enumeration	3

### simpleType Serie\_Registrazione\_Contratto\_Type

namespace	urn:www.agenziaentrate.gov.it:specificheTecniche:sco:730	
type	restriction of <a href="#">DatoAN_Type</a>	
facets	Kind	Value
	pattern	([0-9A-Z\-\-]]&quot;){1}([ 0-9A-Z&amp;]] ' -\ \. / ° ^\ (\\) À È É Ì Ò Ù Ü &quot; \\ / +)*
	enumeration	3
	enumeration	3A
	enumeration	3B
	enumeration	3P
	enumeration	1T
	enumeration	3T

### simpleType Stato\_Civile\_Type

namespace	urn:www.agenziaentrate.gov.it:specificheTecniche:sco:730	
type	restriction of <a href="#">DatoNP_Type</a>	
facets	Kind	Value
	pattern	[1-9]{1}[0-9]*
	enumeration	7
	enumeration	8

### simpleType Terreni\_Urbano\_Type

namespace	urn:www.agenziaentrate.gov.it:specificheTecniche:sco:730	
type	restriction of <a href="#">DatoAN_Type</a>	

facets	Kind	Value
	pattern	([0-9A-Z-])&quot;){1}([ 0-9A-Z&amp;#38;#39;] ' \" / ° \\^\\(\\ )À É Ê Ï Ò Ù Ü &quot; \\ \\ \\+)*
	enumeration	T
	enumeration	U

### simpleType **Tipo\_Inquilino\_Type**

namespace	urn:www.agenziaentrate.gov.it:specificheTecniche:sco:730	
type	restriction of <a href="#">DatoNP_Type</a>	
facets	Kind	Value
	pattern	[1-9]{1}[0-9]*
	enumeration	1
	enumeration	2
enumeration	3	

### simpleType **Tipo\_Intervento\_Type**

namespace	urn:www.agenziaentrate.gov.it:specificheTecniche:sco:730	
type	restriction of <a href="#">DatoN1_Type</a>	
facets	Kind	Value
	pattern	[1-9]
	enumeration	1
	enumeration	2
	enumeration	3
	enumeration	4
	enumeration	5
	enumeration	6
	enumeration	7
	enumeration	8
enumeration	9	

### simpleType **Tipo\_Reddito\_Da1a4\_Type**

namespace	urn:www.agenziaentrate.gov.it:specificheTecniche:sco:730	
type	restriction of <a href="#">DatoN1_Type</a>	
facets	Kind	Value
	pattern	[1-9]
	enumeration	1
	enumeration	2
	enumeration	3
enumeration	4	

### simpleType **Tipo\_Reddito\_Da1a8\_Type**

namespace	urn:www.agenziaentrate.gov.it:specificheTecniche:sco:730	
type	restriction of <a href="#">DatoNP_Type</a>	
facets	Kind	Value
	pattern	[1-9]{1}[0-9]*
	enumeration	1
	enumeration	2
	enumeration	3
	enumeration	4
	enumeration	5
	enumeration	6
enumeration	7	
enumeration	8	

**simpleType Tipologia\_Soggetto\_Ass\_Fisc\_Type**

namespace	urn:www.agenziaentrate.gov.it:specificheTecniche:sco:730														
type	restriction of <a href="#">DatoN1_Type</a>														
facets	<table border="1"> <thead> <tr> <th>Kind</th> <th>Value</th> </tr> </thead> <tbody> <tr> <td>pattern</td> <td>[1-9]</td> </tr> <tr> <td>enumeration</td> <td>1</td> </tr> <tr> <td>enumeration</td> <td>2</td> </tr> <tr> <td>enumeration</td> <td>3</td> </tr> <tr> <td>enumeration</td> <td>4</td> </tr> <tr> <td>enumeration</td> <td>5</td> </tr> </tbody> </table>	Kind	Value	pattern	[1-9]	enumeration	1	enumeration	2	enumeration	3	enumeration	4	enumeration	5
Kind	Value														
pattern	[1-9]														
enumeration	1														
enumeration	2														
enumeration	3														
enumeration	4														
enumeration	5														

**simpleType Titolo\_Terreno\_Type**

namespace	urn:www.agenziaentrate.gov.it:specificheTecniche:sco:730																				
type	restriction of <a href="#">DatoNP_Type</a>																				
facets	<table border="1"> <thead> <tr> <th>Kind</th> <th>Value</th> </tr> </thead> <tbody> <tr> <td>pattern</td> <td>[1-9]{1}[0-9]*</td> </tr> <tr> <td>enumeration</td> <td>1</td> </tr> <tr> <td>enumeration</td> <td>2</td> </tr> <tr> <td>enumeration</td> <td>3</td> </tr> <tr> <td>enumeration</td> <td>4</td> </tr> <tr> <td>enumeration</td> <td>5</td> </tr> <tr> <td>enumeration</td> <td>6</td> </tr> <tr> <td>enumeration</td> <td>7</td> </tr> <tr> <td>enumeration</td> <td>10</td> </tr> </tbody> </table>	Kind	Value	pattern	[1-9]{1}[0-9]*	enumeration	1	enumeration	2	enumeration	3	enumeration	4	enumeration	5	enumeration	6	enumeration	7	enumeration	10
Kind	Value																				
pattern	[1-9]{1}[0-9]*																				
enumeration	1																				
enumeration	2																				
enumeration	3																				
enumeration	4																				
enumeration	5																				
enumeration	6																				
enumeration	7																				
enumeration	10																				

**simpleType Utilizzo\_Fabbricato\_Type**

namespace	urn:www.agenziaentrate.gov.it:specificheTecniche:sco:730																																
type	restriction of <a href="#">DatoNP_Type</a>																																
facets	<table border="1"> <thead> <tr> <th>Kind</th> <th>Value</th> </tr> </thead> <tbody> <tr> <td>pattern</td> <td>[1-9]{1}[0-9]*</td> </tr> <tr> <td>enumeration</td> <td>1</td> </tr> <tr> <td>enumeration</td> <td>2</td> </tr> <tr> <td>enumeration</td> <td>3</td> </tr> <tr> <td>enumeration</td> <td>4</td> </tr> <tr> <td>enumeration</td> <td>5</td> </tr> <tr> <td>enumeration</td> <td>8</td> </tr> <tr> <td>enumeration</td> <td>9</td> </tr> <tr> <td>enumeration</td> <td>10</td> </tr> <tr> <td>enumeration</td> <td>11</td> </tr> <tr> <td>enumeration</td> <td>12</td> </tr> <tr> <td>enumeration</td> <td>14</td> </tr> <tr> <td>enumeration</td> <td>15</td> </tr> <tr> <td>enumeration</td> <td>16</td> </tr> <tr> <td>enumeration</td> <td>17</td> </tr> </tbody> </table>	Kind	Value	pattern	[1-9]{1}[0-9]*	enumeration	1	enumeration	2	enumeration	3	enumeration	4	enumeration	5	enumeration	8	enumeration	9	enumeration	10	enumeration	11	enumeration	12	enumeration	14	enumeration	15	enumeration	16	enumeration	17
Kind	Value																																
pattern	[1-9]{1}[0-9]*																																
enumeration	1																																
enumeration	2																																
enumeration	3																																
enumeration	4																																
enumeration	5																																
enumeration	8																																
enumeration	9																																
enumeration	10																																
enumeration	11																																
enumeration	12																																
enumeration	14																																
enumeration	15																																
enumeration	16																																
enumeration	17																																

### complexType Dati\_Anagrafici\_Type

diagram	
namespace	urn:www.agenziaentrate.gov.it:specificheTecniche:sco:common
children	<a href="#">Cognome</a> <a href="#">Nome</a> <a href="#">Sesso</a> <a href="#">DataNascita</a> <a href="#">ComuneNascita</a> <a href="#">ProvinciaNascita</a>

### element Dati\_Anagrafici\_Type/Cognome

diagram					
namespace	urn:www.agenziaentrate.gov.it:specificheTecniche:sco:common				
type	<a href="#">DatoAN_Type</a>				
facets	<table border="1"> <tr> <td>Kind</td> <td>Value</td> </tr> <tr> <td>pattern</td> <td>(([0-9A-Z-] \&amp;quot;){1}([ 0-9A-Z&amp;amp;:] ' - \., / ° '^\(\\ )\) À É È Ì Ò Ù Ü &amp;quot;; \\N \\+)*</td> </tr> </table>	Kind	Value	pattern	(([0-9A-Z-] \&quot;){1}([ 0-9A-Z&amp;:] ' - \., / ° '^\(\\ )\) À É È Ì Ò Ù Ü &quot;; \\N \\+)*
Kind	Value				
pattern	(([0-9A-Z-] \&quot;){1}([ 0-9A-Z&amp;:] ' - \., / ° '^\(\\ )\) À É È Ì Ò Ù Ü &quot;; \\N \\+)*				

### element Dati\_Anagrafici\_Type/Nome

diagram					
namespace	urn:www.agenziaentrate.gov.it:specificheTecniche:sco:common				
type	<a href="#">DatoAN_Type</a>				
facets	<table border="1"> <tr> <td>Kind</td> <td>Value</td> </tr> <tr> <td>pattern</td> <td>(([0-9A-Z-] \&amp;quot;){1}([ 0-9A-Z&amp;amp;:] ' - \., / ° '^\(\\ )\) À É È Ì Ò Ù Ü &amp;quot;; \\N \\+)*</td> </tr> </table>	Kind	Value	pattern	(([0-9A-Z-] \&quot;){1}([ 0-9A-Z&amp;:] ' - \., / ° '^\(\\ )\) À É È Ì Ò Ù Ü &quot;; \\N \\+)*
Kind	Value				
pattern	(([0-9A-Z-] \&quot;){1}([ 0-9A-Z&amp;:] ' - \., / ° '^\(\\ )\) À É È Ì Ò Ù Ü &quot;; \\N \\+)*				

### element Dati\_Anagrafici\_Type/Sesso

diagram									
namespace	urn:www.agenziaentrate.gov.it:specificheTecniche:sco:common								
type	<a href="#">Sesso_Type</a>								
facets	<table border="1"> <tr> <td>Kind</td> <td>Value</td> </tr> <tr> <td>pattern</td> <td>(([0-9A-Z-] \&amp;quot;){1}([ 0-9A-Z&amp;amp;:] ' - \., / ° '^\(\\ )\) À É È Ì Ò Ù Ü &amp;quot;; \\N \\+)*</td> </tr> <tr> <td>enumeration</td> <td>M</td> </tr> <tr> <td>enumeration</td> <td>F</td> </tr> </table>	Kind	Value	pattern	(([0-9A-Z-] \&quot;){1}([ 0-9A-Z&amp;:] ' - \., / ° '^\(\\ )\) À É È Ì Ò Ù Ü &quot;; \\N \\+)*	enumeration	M	enumeration	F
Kind	Value								
pattern	(([0-9A-Z-] \&quot;){1}([ 0-9A-Z&amp;:] ' - \., / ° '^\(\\ )\) À É È Ì Ò Ù Ü &quot;; \\N \\+)*								
enumeration	M								
enumeration	F								

element **Dati\_Anagrafici\_Type/DataNascita**

diagram					
namespace	urn:www.agenziaentrate.gov.it:specificheTecniche:sco:common				
type	<a href="#">DatoDT_Type</a>				
facets	<table border="0"> <tr> <td>Kind</td> <td>Value</td> </tr> <tr> <td>pattern</td> <td>((([0-9][1-9][12][0-9][301])(0[13578][1012]\d{4})) ((([0][1-9][12][0-9][30](0[469][11]\d{4})) ((0[1-9][1[0-9][2[0-8])(02)\d{4})) ((29)(02)[02468][048]00)) ((29)(02)[13579][26]00)) ((29)(02)[0-9][0][48])) ((29)(02)[0-9][0-9][2468][048])) ((29)(02)[0-9][0-9][13579][26]))</td> </tr> </table>	Kind	Value	pattern	((([0-9][1-9][12][0-9][301])(0[13578][1012]\d{4})) ((([0][1-9][12][0-9][30](0[469][11]\d{4})) ((0[1-9][1[0-9][2[0-8])(02)\d{4})) ((29)(02)[02468][048]00)) ((29)(02)[13579][26]00)) ((29)(02)[0-9][0][48])) ((29)(02)[0-9][0-9][2468][048])) ((29)(02)[0-9][0-9][13579][26]))
Kind	Value				
pattern	((([0-9][1-9][12][0-9][301])(0[13578][1012]\d{4})) ((([0][1-9][12][0-9][30](0[469][11]\d{4})) ((0[1-9][1[0-9][2[0-8])(02)\d{4})) ((29)(02)[02468][048]00)) ((29)(02)[13579][26]00)) ((29)(02)[0-9][0][48])) ((29)(02)[0-9][0-9][2468][048])) ((29)(02)[0-9][0-9][13579][26]))				

element **Dati\_Anagrafici\_Type/ComuneNascita**

diagram					
namespace	urn:www.agenziaentrate.gov.it:specificheTecniche:sco:common				
type	<a href="#">DatoAN_Type</a>				
facets	<table border="0"> <tr> <td>Kind</td> <td>Value</td> </tr> <tr> <td>pattern</td> <td>([0-9A-Z-] \&amp;quot;){1}([ 0-9A-Z&amp;amp;:] \- \. , / \^\(\ \) À È É Ì Ò Ù Û \&amp;quot; \ \\ \ +)*</td> </tr> </table>	Kind	Value	pattern	([0-9A-Z-] \&quot;){1}([ 0-9A-Z&amp;:] \- \. , / \^\(\ \) À È É Ì Ò Ù Û \&quot; \ \\ \ +)*
Kind	Value				
pattern	([0-9A-Z-] \&quot;){1}([ 0-9A-Z&amp;:] \- \. , / \^\(\ \) À È É Ì Ò Ù Û \&quot; \ \\ \ +)*				

element **Dati\_Anagrafici\_Type/ProvinciaNascita**

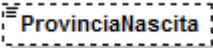
diagram	
namespace	urn:www.agenziaentrate.gov.it:specificheTecniche:sco:common
type	<a href="#">PN_Type</a>

complexType **Dati\_Sottoscrittore\_Type**

diagram	
namespace	urn:www.agenziaentrate.gov.it:specificheTecniche:sco:common
children	<a href="#">CodiceFiscale</a> <a href="#">CodiceCarica</a> <a href="#">CodiceFiscaleSocieta</a> <a href="#">DatiAnagrafici</a> <a href="#">ResidenzaEstera</a> <a href="#">Telefono</a> <a href="#">DataCarica</a> <a href="#">InizioProcedura</a> <a href="#">ProceduraNonTerminata</a> <a href="#">FineProcedura</a>

element **Dati\_Sottoscrittore\_Type/CodiceFiscale**

diagram					
namespace	urn:www.agenziaentrate.gov.it:specificheTecniche:sco:common				
type	<a href="#">DatoCF_Type</a>				
facets	<table border="1"> <thead> <tr> <th>Kind</th> <th>Value</th> </tr> </thead> <tbody> <tr> <td>pattern</td> <td>[0-9]{11}[A-Z]{6}[0-9LMNPQRSTUW]{2}[A-Z]{1}[0-9LMNPQRSTUW]{2}[A-Z]{1}[0-9LMNPQRSTUW]{3}[A-Z]{1}</td> </tr> </tbody> </table>	Kind	Value	pattern	[0-9]{11}[A-Z]{6}[0-9LMNPQRSTUW]{2}[A-Z]{1}[0-9LMNPQRSTUW]{2}[A-Z]{1}[0-9LMNPQRSTUW]{3}[A-Z]{1}
Kind	Value				
pattern	[0-9]{11}[A-Z]{6}[0-9LMNPQRSTUW]{2}[A-Z]{1}[0-9LMNPQRSTUW]{2}[A-Z]{1}[0-9LMNPQRSTUW]{3}[A-Z]{1}				

element **Dati\_Sottoscrittore\_Type/CodiceCarica**

diagram																			
namespace	urn:www.agenziaentrate.gov.it:specificheTecniche:sco:common																		
type	<a href="#">Codice_Carica_Type</a>																		
facets	<table border="1"> <thead> <tr> <th>Kind</th> <th>Value</th> </tr> </thead> <tbody> <tr> <td>pattern</td> <td>[1-9]{1}[0-9]*</td> </tr> <tr> <td>enumeration</td> <td>1</td> </tr> <tr> <td>enumeration</td> <td>2</td> </tr> <tr> <td>enumeration</td> <td>3</td> </tr> <tr> <td>enumeration</td> <td>4</td> </tr> <tr> <td>enumeration</td> <td>5</td> </tr> <tr> <td>enumeration</td> <td>6</td> </tr> <tr> <td>enumeration</td> <td>7</td> </tr> </tbody> </table>	Kind	Value	pattern	[1-9]{1}[0-9]*	enumeration	1	enumeration	2	enumeration	3	enumeration	4	enumeration	5	enumeration	6	enumeration	7
Kind	Value																		
pattern	[1-9]{1}[0-9]*																		
enumeration	1																		
enumeration	2																		
enumeration	3																		
enumeration	4																		
enumeration	5																		
enumeration	6																		
enumeration	7																		

	enumeration	8
	enumeration	9
	enumeration	10
	enumeration	11
	enumeration	12
	enumeration	13
	enumeration	14
	enumeration	15

element **Dati\_Sottoscrittore\_Type/CodiceFiscaleSocieta**

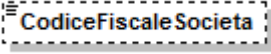
diagram		
namespace	urn:www.agenziaentrate.gov.it:specificheTecniche:sco:common	
type	<a href="#">DatoCN_Type</a>	
facets	Kind	Value
	pattern	[0-9]{11}

element **Dati\_Sottoscrittore\_Type/DatiAnagrafici**

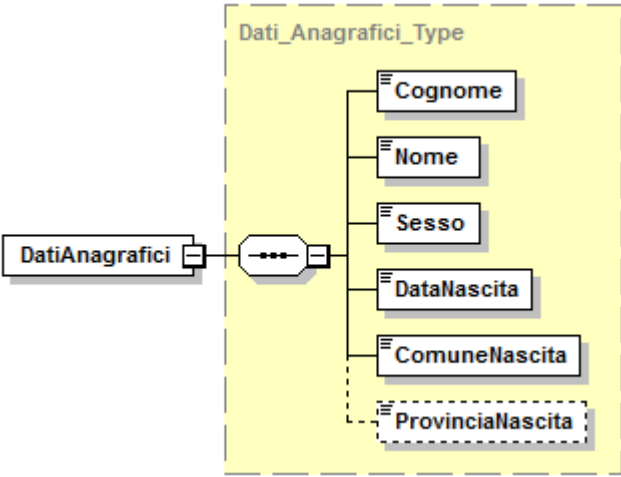
diagram		
namespace	urn:www.agenziaentrate.gov.it:specificheTecniche:sco:common	
type	<a href="#">Dati_Anagrafici_Type</a>	
children	<a href="#">Cognome</a> <a href="#">Nome</a> <a href="#">Sesso</a> <a href="#">DataNascita</a> <a href="#">ComuneNascita</a> <a href="#">ProvinciaNascita</a>	

element **Dati\_Sottoscrittore\_Type/ResidenzaEstera**

diagram	
namespace	urn:www.agenziaentrate.gov.it:specificheTecniche:sco:common
type	<a href="#">Residenza_Estera_Type</a>
children	<a href="#">CodiceStatoEstero</a> <a href="#">StatoFederato</a> <a href="#">LocalitaEstero</a> <a href="#">IndirizzoEstero</a>

element **Dati\_Sottoscrittore\_Type/Telefono**

diagram					
namespace	urn:www.agenziaentrate.gov.it:specificheTecniche:sco:common				
type	<a href="#">DatoTL_Type</a>				
facets	<table border="1"> <thead> <tr> <th>Kind</th> <th>Value</th> </tr> </thead> <tbody> <tr> <td>pattern</td> <td>[0-9]*</td> </tr> </tbody> </table>	Kind	Value	pattern	[0-9]*
Kind	Value				
pattern	[0-9]*				

element **Dati\_Sottoscrittore\_Type/DataCarica**

diagram					
namespace	urn:www.agenziaentrate.gov.it:specificheTecniche:sco:common				
type	<a href="#">DatoDT_Type</a>				
facets	<table border="1"> <thead> <tr> <th>Kind</th> <th>Value</th> </tr> </thead> <tbody> <tr> <td>pattern</td> <td>((([0-9]{1,2}[0-9]{3,4}) (0[13578][10]12\d{4})) ((([0-9]{1,2}[0-9]{3,4}) (0[469][11]\d{4})) ((([0-9]{1,2}[0-9]{3,4}) (29)(02)([02468][048]00)) ((29)(02)([13579][26]00)) ((29)(02)([0-9][0][48])) ((29)(02)([0-9][2468][048])) ((29)(02)([0-9][0-9][13579][26])))))</td> </tr> </tbody> </table>	Kind	Value	pattern	((([0-9]{1,2}[0-9]{3,4}) (0[13578][10]12\d{4})) ((([0-9]{1,2}[0-9]{3,4}) (0[469][11]\d{4})) ((([0-9]{1,2}[0-9]{3,4}) (29)(02)([02468][048]00)) ((29)(02)([13579][26]00)) ((29)(02)([0-9][0][48])) ((29)(02)([0-9][2468][048])) ((29)(02)([0-9][0-9][13579][26])))))
Kind	Value				
pattern	((([0-9]{1,2}[0-9]{3,4}) (0[13578][10]12\d{4})) ((([0-9]{1,2}[0-9]{3,4}) (0[469][11]\d{4})) ((([0-9]{1,2}[0-9]{3,4}) (29)(02)([02468][048]00)) ((29)(02)([13579][26]00)) ((29)(02)([0-9][0][48])) ((29)(02)([0-9][2468][048])) ((29)(02)([0-9][0-9][13579][26])))))				

element **Dati\_Sottoscrittore\_Type/InizioProcedura**

diagram					
namespace	urn:www.agenziaentrate.gov.it:specificheTecniche:sco:common				
type	<a href="#">DatoDT_Type</a>				
facets	<table border="1"> <thead> <tr> <th>Kind</th> <th>Value</th> </tr> </thead> <tbody> <tr> <td>pattern</td> <td>((([0-9]{1,2}[0-9]{3,4}) (0[13578][10]12\d{4})) ((([0-9]{1,2}[0-9]{3,4}) (0[469][11]\d{4})) ((([0-9]{1,2}[0-9]{3,4}) (29)(02)([02468][048]00)) ((29)(02)([13579][26]00)) ((29)(02)([0-9][0][48])) ((29)(02)([0-9][2468][048])) ((29)(02)([0-9][0-9][13579][26])))))</td> </tr> </tbody> </table>	Kind	Value	pattern	((([0-9]{1,2}[0-9]{3,4}) (0[13578][10]12\d{4})) ((([0-9]{1,2}[0-9]{3,4}) (0[469][11]\d{4})) ((([0-9]{1,2}[0-9]{3,4}) (29)(02)([02468][048]00)) ((29)(02)([13579][26]00)) ((29)(02)([0-9][0][48])) ((29)(02)([0-9][2468][048])) ((29)(02)([0-9][0-9][13579][26])))))
Kind	Value				
pattern	((([0-9]{1,2}[0-9]{3,4}) (0[13578][10]12\d{4})) ((([0-9]{1,2}[0-9]{3,4}) (0[469][11]\d{4})) ((([0-9]{1,2}[0-9]{3,4}) (29)(02)([02468][048]00)) ((29)(02)([13579][26]00)) ((29)(02)([0-9][0][48])) ((29)(02)([0-9][2468][048])) ((29)(02)([0-9][0-9][13579][26])))))				



element **Dati\_Sottoscrittore\_Type/ProceduraNonTerminata**

diagram	
namespace	urn:www.agenziaentrate.gov.it:specificheTecniche:sco:common
type	<a href="#">DatoCB_Type</a>
facets	Kind Value pattern [01]

element **Dati\_Sottoscrittore\_Type/FineProcedura**

diagram	
namespace	urn:www.agenziaentrate.gov.it:specificheTecniche:sco:common
type	<a href="#">DatoDT_Type</a>
facets	Kind Value pattern ((([0-9]{12}[0-9]{3}[01])(0[13578][1012](\d{4})) ([0-9]{12}[0-9]{30}(0[469][11](\d{4})) ([0-9]{11}[0-9]{2}[0-8])(02)(\d{4})) ((29)(02)([02468][048]00)) ((29)(02)([13579][26]00)) ((29)(02)([0-9][0-9][0][48])) ((29)(02)([0-9][0-9][2468][048])) ((29)(02)([0-9][0-9][13579][26]))))

complexType **Domicilio\_EE\_Type**

diagram	
namespace	urn:www.agenziaentrate.gov.it:specificheTecniche:sco:common
children	<a href="#">Comune</a> <a href="#">Provincia</a> <a href="#">CodiceComune</a> <a href="#">Indirizzo</a> <a href="#">Cap</a> <a href="#">DataVariazione</a>

element **Domicilio\_EE\_Type/Comune**

diagram	
namespace	urn:www.agenziaentrate.gov.it:specificheTecniche:sco:common
type	<a href="#">DatoAN_Type</a>
facets	Kind Value

pattern	(([0-9A-Z-] \&quot;){1}([ 0-9A-Z&amp;#39; ' - \., / ^ \^\(\ \)\ À É È Ì Ò Ù Ü &quot; \ \ /+)*
---------	---

#### element Domicilio\_EE\_Type/Provincia

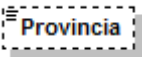
diagram	
namespace	urn:www.agenziaentrate.gov.it:specificheTecniche:sco:common
type	<a href="#">PE_Type</a>

#### element Domicilio\_EE\_Type/CodiceComune

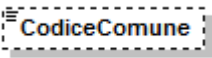
diagram	
namespace	urn:www.agenziaentrate.gov.it:specificheTecniche:sco:common
type	<a href="#">DatoAN_Type</a>
facets	Kind Value pattern (([0-9A-Z-] \&quot;){1}([ 0-9A-Z&amp;#39; ' - \., / ^ \^\(\ \)\ À É È Ì Ò Ù Ü &quot; \ \ /+)*

#### element Domicilio\_EE\_Type/Indirizzo

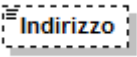
diagram	
namespace	urn:www.agenziaentrate.gov.it:specificheTecniche:sco:common
type	<a href="#">DatoAN_Type</a>
facets	Kind Value pattern (([0-9A-Z-] \&quot;){1}([ 0-9A-Z&amp;#39; ' - \., / ^ \^\(\ \)\ À É È Ì Ò Ù Ü &quot; \ \ /+)*

#### element Domicilio\_EE\_Type/Cap

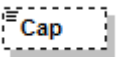
diagram	
namespace	urn:www.agenziaentrate.gov.it:specificheTecniche:sco:common
type	<a href="#">DatoCP_Type</a>
facets	Kind Value pattern [0-9]{5}

#### element Domicilio\_EE\_Type/DataVariazione

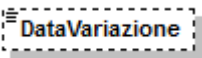
diagram	
namespace	urn:www.agenziaentrate.gov.it:specificheTecniche:sco:common
type	<a href="#">DatoD6_Type</a>
facets	Kind Value pattern (([0-9])([10-2]))((19 20)[0-9][0-9])

complexType **Domicilio\_Fiscale\_Type**

diagram	
namespace	urn:www.agenziaentrate.gov.it:specificheTecniche:sco:common
type	extension of <a href="#">Domicilio_Ita_Type</a>
children	<a href="#">Comune</a> <a href="#">Provincia</a> <a href="#">CodiceComune</a> <a href="#">Indirizzo</a> <a href="#">Cap</a> <a href="#">DataVariazione</a>

element **Domicilio\_Fiscale\_Type/DataVariazione**

diagram					
namespace	urn:www.agenziaentrate.gov.it:specificheTecniche:sco:common				
type	<a href="#">DatoD6_Type</a>				
facets	<table border="0"> <tr> <td>Kind</td> <td>Value</td> </tr> <tr> <td>pattern</td> <td>((0[0-9]) (1[0-2]))((19 20)[0-9][0-9])</td> </tr> </table>	Kind	Value	pattern	((0[0-9]) (1[0-2]))((19 20)[0-9][0-9])
Kind	Value				
pattern	((0[0-9]) (1[0-2]))((19 20)[0-9][0-9])				

complexType **Domicilio\_Ita\_Type**

diagram	
namespace	urn:www.agenziaentrate.gov.it:specificheTecniche:sco:common
children	<a href="#">Comune</a> <a href="#">Provincia</a> <a href="#">CodiceComune</a> <a href="#">Indirizzo</a> <a href="#">Cap</a>

element **Domicilio\_Ita\_Type/Comune**

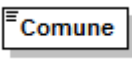
diagram	
namespace	urn:www.agenziaentrate.gov.it:specificheTecniche:sco:common
type	<a href="#">DatoAN_Type</a>
facets	Kind Value pattern ([0-9A-Z-]*)&quot;}{1}([ 0-9A-Z&amp;:] ' - \., / ^ \^\(\ \)\ À É È Ì Ò Ù Ü &quot; \ \\ \ +)*

element **Domicilio\_Ita\_Type/Provincia**

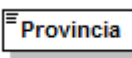
diagram	
namespace	urn:www.agenziaentrate.gov.it:specificheTecniche:sco:common
type	<a href="#">PR_Type</a>

element **Domicilio\_Ita\_Type/CodiceComune**

diagram	
namespace	urn:www.agenziaentrate.gov.it:specificheTecniche:sco:common
type	<a href="#">DatoAN_Type</a>
facets	Kind Value pattern ([0-9A-Z-]*)&quot;}{1}([ 0-9A-Z&amp;:] ' - \., / ^ \^\(\ \)\ À É È Ì Ò Ù Ü &quot; \ \\ \ +)*

element **Domicilio\_Ita\_Type/Indirizzo**

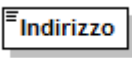
diagram	
namespace	urn:www.agenziaentrate.gov.it:specificheTecniche:sco:common
type	<a href="#">DatoAN_Type</a>
facets	Kind Value pattern ([0-9A-Z-]*)&quot;}{1}([ 0-9A-Z&amp;:] ' - \., / ^ \^\(\ \)\ À É È Ì Ò Ù Ü &quot; \ \\ \ +)*

element **Domicilio\_Ita\_Type/Cap**

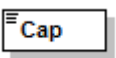
diagram	
namespace	urn:www.agenziaentrate.gov.it:specificheTecniche:sco:common
type	<a href="#">DatoCP_Type</a>
facets	Kind Value pattern [0-9]{5}

### complexType Firma\_Revisione\_Type

diagram	
namespace	urn:www.agenziaentrate.gov.it:specificheTecniche:sco:common
children	<a href="#">Soggetto</a> <a href="#">CodiceFiscale</a> <a href="#">FirmaDichiarante</a>

### element Firma\_Revisione\_Type/Soggetto

diagram					
namespace	urn:www.agenziaentrate.gov.it:specificheTecniche:sco:common				
type	restriction of <a href="#">DatoNP_Type</a>				
facets	<table border="1"> <tr> <td>Kind</td> <td>Value</td> </tr> <tr> <td>pattern</td> <td>[1-4]</td> </tr> </table>	Kind	Value	pattern	[1-4]
Kind	Value				
pattern	[1-4]				

### element Firma\_Revisione\_Type/CodiceFiscale

diagram					
namespace	urn:www.agenziaentrate.gov.it:specificheTecniche:sco:common				
type	<a href="#">DatoCF_Type</a>				
facets	<table border="1"> <tr> <td>Kind</td> <td>Value</td> </tr> <tr> <td>pattern</td> <td>[0-9]{1}[A-Z]{6}[0-9LMNPQRSTU]{2}[A-Z]{1}[0-9LMNPQRSTU]{2}[A-Z]{1}[0-9LMNPQRSTU]{3}[A-Z]{1}</td> </tr> </table>	Kind	Value	pattern	[0-9]{1}[A-Z]{6}[0-9LMNPQRSTU]{2}[A-Z]{1}[0-9LMNPQRSTU]{2}[A-Z]{1}[0-9LMNPQRSTU]{3}[A-Z]{1}
Kind	Value				
pattern	[0-9]{1}[A-Z]{6}[0-9LMNPQRSTU]{2}[A-Z]{1}[0-9LMNPQRSTU]{2}[A-Z]{1}[0-9LMNPQRSTU]{3}[A-Z]{1}				

### element Firma\_Revisione\_Type/FirmaDichiarante

diagram					
namespace	urn:www.agenziaentrate.gov.it:specificheTecniche:sco:common				
type	<a href="#">DatoCB_Type</a>				
facets	<table border="1"> <tr> <td>Kind</td> <td>Value</td> </tr> <tr> <td>pattern</td> <td>[01]</td> </tr> </table>	Kind	Value	pattern	[01]
Kind	Value				
pattern	[01]				

### complexType Firma\_Type

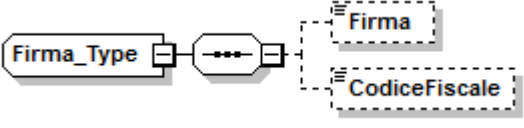
diagram	
namespace	urn:www.agenziaentrate.gov.it:specificheTecniche:sco:common
children	<a href="#">Firma</a> <a href="#">CodiceFiscale</a>

### element Firma\_Type/Firma

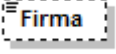
diagram	
namespace	urn:www.agenziaentrate.gov.it:specificheTecniche:sco:common
type	<a href="#">DatoCB_Type</a>
facets	Kind Value pattern [01]

### element Firma\_Type/CodiceFiscale

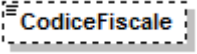
diagram	
namespace	urn:www.agenziaentrate.gov.it:specificheTecniche:sco:common
type	restriction of <b>xs:string</b>
facets	Kind Value pattern ([0-9A-Z-] \&quot;){0,1}([0-9A-Z&amp;] ' \" data-bbox="195 525 745 545"/>

### complexType Frontespizio\_Type

diagram	
namespace	urn:www.agenziaentrate.gov.it:specificheTecniche:sco:common
children	<a href="#">SoggettoFiscale</a>

element **Frontespizio\_Type/SoggettoFiscale**

diagram	
namespace	urn:www.agenziaentrate.gov.it:specificheTecniche:sco:common
type	<a href="#">Soggetto_Fiscale_Type</a>
children	<a href="#">CodiceFiscale</a> <a href="#">Email</a> <a href="#">Telefono</a> <a href="#">Fax</a>

complexType **Impegno\_A\_Trasmettere\_Type**

diagram	
namespace	urn:www.agenziaentrate.gov.it:specificheTecniche:sco:common
children	<a href="#">CFintermediario</a> <a href="#">NumerolscrAlboCAF</a> <a href="#">ImpegnoATrasmettere</a> <a href="#">RicezioneAvvisoTelem</a> <a href="#">DataImpegno</a> <a href="#">FirmaIntermediario</a>

element **Impegno\_A\_Trasmettere\_Type/CFintermediario**

diagram					
namespace	urn:www.agenziaentrate.gov.it:specificheTecniche:sco:common				
type	<a href="#">DatoCF_Type</a>				
facets	<table border="1"> <thead> <tr> <th>Kind</th> <th>Value</th> </tr> </thead> <tbody> <tr> <td>pattern</td> <td>[0-9]{11}[A-Z]{6}[0-9LMNPQRSTU]{2}[A-Z]{1}[0-9LMNPQRSTU]{2}[A-Z]{1}[0-9LMNPQRSTU]{3}[A-Z]{1}</td> </tr> </tbody> </table>	Kind	Value	pattern	[0-9]{11}[A-Z]{6}[0-9LMNPQRSTU]{2}[A-Z]{1}[0-9LMNPQRSTU]{2}[A-Z]{1}[0-9LMNPQRSTU]{3}[A-Z]{1}
Kind	Value				
pattern	[0-9]{11}[A-Z]{6}[0-9LMNPQRSTU]{2}[A-Z]{1}[0-9LMNPQRSTU]{2}[A-Z]{1}[0-9LMNPQRSTU]{3}[A-Z]{1}				

element **Impegno\_A\_Trasmettere\_Type/NumerolscrAlboCAF**

diagram	
namespace	urn:www.agenziaentrate.gov.it:specificheTecniche:sco:common
type	restriction of <a href="#">DatoNU_Type</a>
facets	Kind Value pattern $(\{-[1-9]\}[1-9])[0-9]^*$

element **Impegno\_A\_Trasmettere\_Type/ImpegnoATrasmettere**

diagram	
namespace	urn:www.agenziaentrate.gov.it:specificheTecniche:sco:common
type	restriction of <a href="#">DatoNP_Type</a>
facets	Kind Value pattern 1 2 enumeration 1 enumeration 2

element **Impegno\_A\_Trasmettere\_Type/RicezioneAvvisoTelem**

diagram	
namespace	urn:www.agenziaentrate.gov.it:specificheTecniche:sco:common
type	<a href="#">DatoCB_Type</a>
facets	Kind Value pattern [01]

element **Impegno\_A\_Trasmettere\_Type/DatalImpegno**

diagram	
namespace	urn:www.agenziaentrate.gov.it:specificheTecniche:sco:common
type	<a href="#">DatoDT_Type</a>
facets	Kind Value pattern $((([0-9][1-9][12][0-9][301])([0-9][13578][1012](\d{4}))) ([0-9][1-9][12][0-9][30](0[469][11](\d{4}))) ([0-9][1-9][2][0-8])(02)(\d{4})) ((29)(02)([0-9][2468][048]00)) ((29)(02)([1-9][13579][26]00)) ((29)(02)([0-9][0-9][0][48])) ((29)(02)([0-9][0-9][2468][048])) ((29)(02)([0-9][0-9][13579][26]))))$

element **Impegno\_A\_Trasmettere\_Type/FirmaIntermediario**

diagram	
namespace	urn:www.agenziaentrate.gov.it:specificheTecniche:sco:common
type	<a href="#">DatoCB_Type</a>



facets	Kind pattern	Value [01]
--------	-----------------	---------------

### complexType **Persone\_Fisiche\_Type**

diagram	
namespace	urn:www.agenziaentrate.gov.it:specificheTecniche:sco:common
children	<a href="#">DatiAnagrafici</a> <a href="#">ResidenzaAnagrafica</a>

### element **Persone\_Fisiche\_Type/DatiAnagrafici**

diagram	
namespace	urn:www.agenziaentrate.gov.it:specificheTecniche:sco:common
type	<a href="#">Dati_Anagrafici_Type</a>
children	<a href="#">Cognome</a> <a href="#">Nome</a> <a href="#">Sesso</a> <a href="#">DataNascita</a> <a href="#">ComuneNascita</a> <a href="#">ProvinciaNascita</a>

element **Persone\_Fisiche\_Type/ResidenzaAnagrafica**

diagram	
namespace	urn:www.agenziaentrate.gov.it:specificheTecniche:sco:common
type	<a href="#">Residenza_Anagrafica_Type</a>
children	<a href="#">Comune</a> <a href="#">Provincia</a> <a href="#">CodiceComune</a> <a href="#">Indirizzo</a> <a href="#">Cap</a> <a href="#">DataVariazione</a>

complexType **Residenza\_Anagrafica\_Type**

diagram	
namespace	urn:www.agenziaentrate.gov.it:specificheTecniche:sco:common
type	extension of <a href="#">Domicilio_Ita_Type</a>
children	<a href="#">Comune</a> <a href="#">Provincia</a> <a href="#">CodiceComune</a> <a href="#">Indirizzo</a> <a href="#">Cap</a> <a href="#">DataVariazione</a>

element **Residenza\_Anagrafica\_Type/DataVariazione**

diagram	
---------	--

namespace	urn:www.agenziaentrate.gov.it:specificheTecniche:sco:common				
type	<a href="#">DatoDT_Type</a>				
facets	<table border="1"> <thead> <tr> <th>Kind</th> <th>Value</th> </tr> </thead> <tbody> <tr> <td>pattern</td> <td>((([0-9]{12} [0-9]{3}[01]{0}[13578]{10} 12)\d{4}) ((([0-9]{11} [0-9]{30})([469]{11})\d{4}) ((([0-9]{1}[0-9]{2}[0-8])([02]\d{4}) ((29)(02)[02468][048]00)) ((29)(02)[13579][26]00)) ((29)(02)[0-9][01][48]) ((29)(02)[0-9][0-9][2468][048]) ((29)(02)[0-9][13579][26]))))</td> </tr> </tbody> </table>	Kind	Value	pattern	((([0-9]{12} [0-9]{3}[01]{0}[13578]{10} 12)\d{4}) ((([0-9]{11} [0-9]{30})([469]{11})\d{4}) ((([0-9]{1}[0-9]{2}[0-8])([02]\d{4}) ((29)(02)[02468][048]00)) ((29)(02)[13579][26]00)) ((29)(02)[0-9][01][48]) ((29)(02)[0-9][0-9][2468][048]) ((29)(02)[0-9][13579][26]))))
Kind	Value				
pattern	((([0-9]{12} [0-9]{3}[01]{0}[13578]{10} 12)\d{4}) ((([0-9]{11} [0-9]{30})([469]{11})\d{4}) ((([0-9]{1}[0-9]{2}[0-8])([02]\d{4}) ((29)(02)[02468][048]00)) ((29)(02)[13579][26]00)) ((29)(02)[0-9][01][48]) ((29)(02)[0-9][0-9][2468][048]) ((29)(02)[0-9][13579][26]))))				

### complexType **Residenza\_Estera\_Type**

diagram	
namespace	urn:www.agenziaentrate.gov.it:specificheTecniche:sco:common
children	<a href="#">CodiceStatoEstero</a> <a href="#">StatoFederato</a> <a href="#">LocalitaEstero</a> <a href="#">IndirizzoEstero</a>

### element **Residenza\_Estera\_Type/CodiceStatoEstero**

diagram					
namespace	urn:www.agenziaentrate.gov.it:specificheTecniche:sco:common				
type	restriction of <a href="#">DatoAN_Type</a>				
facets	<table border="1"> <thead> <tr> <th>Kind</th> <th>Value</th> </tr> </thead> <tbody> <tr> <td>pattern</td> <td>([0-9A-Z\-\&amp;quot;]{1} ([ 0-9A-Z&amp;amp;:] ' - \., / ^ \^\(\ \)\ À È É Ì Ò Ù Û &amp;quot; \ \\ \ +)*</td> </tr> </tbody> </table>	Kind	Value	pattern	([0-9A-Z\-\&quot;]{1} ([ 0-9A-Z&amp;:] ' - \., / ^ \^\(\ \)\ À È É Ì Ò Ù Û &quot; \ \\ \ +)*
Kind	Value				
pattern	([0-9A-Z\-\&quot;]{1} ([ 0-9A-Z&amp;:] ' - \., / ^ \^\(\ \)\ À È É Ì Ò Ù Û &quot; \ \\ \ +)*				

### element **Residenza\_Estera\_Type/StatoFederato**

diagram					
namespace	urn:www.agenziaentrate.gov.it:specificheTecniche:sco:common				
type	restriction of <a href="#">DatoAN_Type</a>				
facets	<table border="1"> <thead> <tr> <th>Kind</th> <th>Value</th> </tr> </thead> <tbody> <tr> <td>pattern</td> <td>([0-9A-Z\-\&amp;quot;]{1} ([ 0-9A-Z&amp;amp;:] ' - \., / ^ \^\(\ \)\ À È É Ì Ò Ù Û &amp;quot; \ \\ \ +)*</td> </tr> </tbody> </table>	Kind	Value	pattern	([0-9A-Z\-\&quot;]{1} ([ 0-9A-Z&amp;:] ' - \., / ^ \^\(\ \)\ À È É Ì Ò Ù Û &quot; \ \\ \ +)*
Kind	Value				
pattern	([0-9A-Z\-\&quot;]{1} ([ 0-9A-Z&amp;:] ' - \., / ^ \^\(\ \)\ À È É Ì Ò Ù Û &quot; \ \\ \ +)*				

### element **Residenza\_Estera\_Type/LocalitaEstero**

diagram	
namespace	urn:www.agenziaentrate.gov.it:specificheTecniche:sco:common
type	<a href="#">DatoAN_Type</a>

facets	Kind	Value
	pattern	(([0-9A-Z-] \&quot;){1}([ 0-9A-Z&amp;#39; " -\. , / "^\(\)\) À È É Ì Ò Ù Ü &quot; \ \\ \ +)*

**element Residenza\_Estera\_Type/IndirizzoEstero**

diagram		
namespace	urn:www.agenziaentrate.gov.it:specificheTecniche:sco:common	
type	<a href="#">DatoAN_Type</a>	
facets	Kind	Value
	pattern	(([0-9A-Z-] \&quot;){1}([ 0-9A-Z&amp;#39; " -\. , / "^\(\)\) À È É Ì Ò Ù Ü &quot; \ \\ \ +)*

**complexType Soggetti\_Diversi\_Da\_PF\_Type**

diagram		
namespace	urn:www.agenziaentrate.gov.it:specificheTecniche:sco:common	
children	<a href="#">Denominazione</a> <a href="#">SedeLegale</a> <a href="#">DomicilioFiscale</a> <a href="#">DataApprovazioneBilancio</a> <a href="#">TermineApprovazioneBilancio</a> <a href="#">InizioPeriodoImposta</a> <a href="#">FinePeriodoImposta</a> <a href="#">Stato</a> <a href="#">NaturaGiuridica</a> <a href="#">Situazione</a>	

**element Soggetti\_Diversi\_Da\_PF\_Type/Denominazione**

diagram		
namespace	urn:www.agenziaentrate.gov.it:specificheTecniche:sco:common	
type	<a href="#">DatoAN_Type</a>	
facets	Kind	Value
	pattern	(([0-9A-Z-] \&quot;){1}([ 0-9A-Z&amp;#39; " -\. , / "^\(\)\) À È É Ì Ò Ù Ü &quot; \ \\ \ +)*

element **Soggetti\_Diversi\_Da\_PF\_Type/SedeLegale**

diagram	
namespace	urn:www.agenziaentrate.gov.it:specificheTecniche:sco:common
type	<a href="#">Domicilio EE Type</a>
children	<a href="#">Comune</a> <a href="#">Provincia</a> <a href="#">CodiceComune</a> <a href="#">Indirizzo</a> <a href="#">Cap</a> <a href="#">DataVariazione</a>

element **Soggetti\_Diversi\_Da\_PF\_Type/DomicilioFiscale**

diagram	
namespace	urn:www.agenziaentrate.gov.it:specificheTecniche:sco:common
type	<a href="#">Domicilio Fiscale Type</a>
children	<a href="#">Comune</a> <a href="#">Provincia</a> <a href="#">CodiceComune</a> <a href="#">Indirizzo</a> <a href="#">Cap</a> <a href="#">DataVariazione</a>

element **Soggetti\_Diversi\_Da\_PF\_Type/DataApprovazioneBilancio**

diagram	
---------	--

namespace	urn:www.agenziaentrate.gov.it:specificheTecniche:sco:common				
type	<a href="#">DatoDT_Type</a>				
facets	<table border="1"> <tr> <td>Kind</td> <td>Value</td> </tr> <tr> <td>pattern</td> <td>((([0-9]{1,2}[0-9]{3,4} 0[13578] 10 12)\d{4}) ([0-9]{1,2}[0-9]{3,4} 0[469] 11)\d{4}) ([0-9]{1,2}[0-9]{2}[0-8])(02)\d{4}) ((29)(02)[02468][048]00) ((29)(02)[13579][26]00) ((29)(02)[0-9][0-9][0148]) ((29)(02)[0-9][0-9][2468][048]) ((29)(02)[0-9][0-9][13579][26]))</td> </tr> </table>	Kind	Value	pattern	((([0-9]{1,2}[0-9]{3,4} 0[13578] 10 12)\d{4}) ([0-9]{1,2}[0-9]{3,4} 0[469] 11)\d{4}) ([0-9]{1,2}[0-9]{2}[0-8])(02)\d{4}) ((29)(02)[02468][048]00) ((29)(02)[13579][26]00) ((29)(02)[0-9][0-9][0148]) ((29)(02)[0-9][0-9][2468][048]) ((29)(02)[0-9][0-9][13579][26]))
Kind	Value				
pattern	((([0-9]{1,2}[0-9]{3,4} 0[13578] 10 12)\d{4}) ([0-9]{1,2}[0-9]{3,4} 0[469] 11)\d{4}) ([0-9]{1,2}[0-9]{2}[0-8])(02)\d{4}) ((29)(02)[02468][048]00) ((29)(02)[13579][26]00) ((29)(02)[0-9][0-9][0148]) ((29)(02)[0-9][0-9][2468][048]) ((29)(02)[0-9][0-9][13579][26]))				

element **Soggetti\_Diversi\_Da\_PF\_Type/TermineApprovazioneBilancio**

diagram					
namespace	urn:www.agenziaentrate.gov.it:specificheTecniche:sco:common				
type	<a href="#">DatoDT_Type</a>				
facets	<table border="1"> <tr> <td>Kind</td> <td>Value</td> </tr> <tr> <td>pattern</td> <td>((([0-9]{1,2}[0-9]{3,4} 0[13578] 10 12)\d{4}) ([0-9]{1,2}[0-9]{3,4} 0[469] 11)\d{4}) ([0-9]{1,2}[0-9]{2}[0-8])(02)\d{4}) ((29)(02)[02468][048]00) ((29)(02)[13579][26]00) ((29)(02)[0-9][0-9][0148]) ((29)(02)[0-9][0-9][2468][048]) ((29)(02)[0-9][0-9][13579][26]))</td> </tr> </table>	Kind	Value	pattern	((([0-9]{1,2}[0-9]{3,4} 0[13578] 10 12)\d{4}) ([0-9]{1,2}[0-9]{3,4} 0[469] 11)\d{4}) ([0-9]{1,2}[0-9]{2}[0-8])(02)\d{4}) ((29)(02)[02468][048]00) ((29)(02)[13579][26]00) ((29)(02)[0-9][0-9][0148]) ((29)(02)[0-9][0-9][2468][048]) ((29)(02)[0-9][0-9][13579][26]))
Kind	Value				
pattern	((([0-9]{1,2}[0-9]{3,4} 0[13578] 10 12)\d{4}) ([0-9]{1,2}[0-9]{3,4} 0[469] 11)\d{4}) ([0-9]{1,2}[0-9]{2}[0-8])(02)\d{4}) ((29)(02)[02468][048]00) ((29)(02)[13579][26]00) ((29)(02)[0-9][0-9][0148]) ((29)(02)[0-9][0-9][2468][048]) ((29)(02)[0-9][0-9][13579][26]))				

element **Soggetti\_Diversi\_Da\_PF\_Type/InizioPeriodoImposta**

diagram					
namespace	urn:www.agenziaentrate.gov.it:specificheTecniche:sco:common				
type	<a href="#">DatoDT_Type</a>				
facets	<table border="1"> <tr> <td>Kind</td> <td>Value</td> </tr> <tr> <td>pattern</td> <td>((([0-9]{1,2}[0-9]{3,4} 0[13578] 10 12)\d{4}) ([0-9]{1,2}[0-9]{3,4} 0[469] 11)\d{4}) ([0-9]{1,2}[0-9]{2}[0-8])(02)\d{4}) ((29)(02)[02468][048]00) ((29)(02)[13579][26]00) ((29)(02)[0-9][0-9][0148]) ((29)(02)[0-9][0-9][2468][048]) ((29)(02)[0-9][0-9][13579][26]))</td> </tr> </table>	Kind	Value	pattern	((([0-9]{1,2}[0-9]{3,4} 0[13578] 10 12)\d{4}) ([0-9]{1,2}[0-9]{3,4} 0[469] 11)\d{4}) ([0-9]{1,2}[0-9]{2}[0-8])(02)\d{4}) ((29)(02)[02468][048]00) ((29)(02)[13579][26]00) ((29)(02)[0-9][0-9][0148]) ((29)(02)[0-9][0-9][2468][048]) ((29)(02)[0-9][0-9][13579][26]))
Kind	Value				
pattern	((([0-9]{1,2}[0-9]{3,4} 0[13578] 10 12)\d{4}) ([0-9]{1,2}[0-9]{3,4} 0[469] 11)\d{4}) ([0-9]{1,2}[0-9]{2}[0-8])(02)\d{4}) ((29)(02)[02468][048]00) ((29)(02)[13579][26]00) ((29)(02)[0-9][0-9][0148]) ((29)(02)[0-9][0-9][2468][048]) ((29)(02)[0-9][0-9][13579][26]))				

element **Soggetti\_Diversi\_Da\_PF\_Type/FinePeriodoImposta**

diagram					
namespace	urn:www.agenziaentrate.gov.it:specificheTecniche:sco:common				
type	<a href="#">DatoDT_Type</a>				
facets	<table border="1"> <tr> <td>Kind</td> <td>Value</td> </tr> <tr> <td>pattern</td> <td>((([0-9]{1,2}[0-9]{3,4} 0[13578] 10 12)\d{4}) ([0-9]{1,2}[0-9]{3,4} 0[469] 11)\d{4}) ([0-9]{1,2}[0-9]{2}[0-8])(02)\d{4}) ((29)(02)[02468][048]00) ((29)(02)[13579][26]00) ((29)(02)[0-9][0-9][0148]) ((29)(02)[0-9][0-9][2468][048]) ((29)(02)[0-9][0-9][13579][26]))</td> </tr> </table>	Kind	Value	pattern	((([0-9]{1,2}[0-9]{3,4} 0[13578] 10 12)\d{4}) ([0-9]{1,2}[0-9]{3,4} 0[469] 11)\d{4}) ([0-9]{1,2}[0-9]{2}[0-8])(02)\d{4}) ((29)(02)[02468][048]00) ((29)(02)[13579][26]00) ((29)(02)[0-9][0-9][0148]) ((29)(02)[0-9][0-9][2468][048]) ((29)(02)[0-9][0-9][13579][26]))
Kind	Value				
pattern	((([0-9]{1,2}[0-9]{3,4} 0[13578] 10 12)\d{4}) ([0-9]{1,2}[0-9]{3,4} 0[469] 11)\d{4}) ([0-9]{1,2}[0-9]{2}[0-8])(02)\d{4}) ((29)(02)[02468][048]00) ((29)(02)[13579][26]00) ((29)(02)[0-9][0-9][0148]) ((29)(02)[0-9][0-9][2468][048]) ((29)(02)[0-9][0-9][13579][26]))				

element **Soggetti\_Diversi\_Da\_PF\_Type/Stato**

diagram			
namespace	urn:www.agenziaentrate.gov.it:specificheTecniche:sco:common		
type	<a href="#">Stato_Type</a>		
facets	<table border="1"> <tr> <td>Kind</td> <td>Value</td> </tr> </table>	Kind	Value
Kind	Value		

	pattern	[1-9]{1}[0-9]*
	enumeration	1
	enumeration	2
	enumeration	3
	enumeration	4

element **Soggetti\_Diversi\_Da\_PF\_Type/NaturaGiuridica**

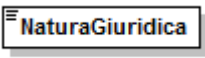
diagram		
namespace	urn:www.agenziaentrate.gov.it:specificheTecniche:sco:common	
type	<a href="#">Natura Giuridica Type</a>	
facets	Kind	Value
	pattern	[1-9]{1}[0-9]*
	enumeration	1
	enumeration	2
	enumeration	3
	enumeration	4
	enumeration	5
	enumeration	6
	enumeration	7
	enumeration	8
	enumeration	9
	enumeration	10
	enumeration	11
	enumeration	12
	enumeration	13
	enumeration	14
	enumeration	15
	enumeration	16
	enumeration	17
	enumeration	18
	enumeration	19
	enumeration	20
	enumeration	21
	enumeration	22
	enumeration	23
	enumeration	24
	enumeration	25
	enumeration	26
	enumeration	27
	enumeration	28
	enumeration	29
	enumeration	30
	enumeration	31
	enumeration	32
	enumeration	33
	enumeration	34
	enumeration	35
	enumeration	36
	enumeration	37
	enumeration	38
	enumeration	39
	enumeration	40
	enumeration	41
	enumeration	42
	enumeration	43
	enumeration	44
	enumeration	45
	enumeration	50
	enumeration	51
	enumeration	52
	enumeration	53

	enumeration	54
	enumeration	55
	enumeration	56
	enumeration	57
	enumeration	58
	enumeration	59

### element **Soggetti\_Diversi\_Da\_PF\_Type/Situazione**

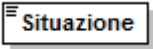
diagram																			
namespace	urn:www.agenziaentrate.gov.it:specificheTecniche:sco:common																		
type	<a href="#">Situazione_Type</a>																		
facets	<table border="1"> <thead> <tr> <th>Kind</th> <th>Value</th> </tr> </thead> <tbody> <tr> <td>pattern</td> <td>[1-9]{1}[0-9]*</td> </tr> <tr> <td>enumeration</td> <td>1</td> </tr> <tr> <td>enumeration</td> <td>2</td> </tr> <tr> <td>enumeration</td> <td>3</td> </tr> <tr> <td>enumeration</td> <td>4</td> </tr> <tr> <td>enumeration</td> <td>5</td> </tr> <tr> <td>enumeration</td> <td>6</td> </tr> <tr> <td>enumeration</td> <td>7</td> </tr> </tbody> </table>	Kind	Value	pattern	[1-9]{1}[0-9]*	enumeration	1	enumeration	2	enumeration	3	enumeration	4	enumeration	5	enumeration	6	enumeration	7
Kind	Value																		
pattern	[1-9]{1}[0-9]*																		
enumeration	1																		
enumeration	2																		
enumeration	3																		
enumeration	4																		
enumeration	5																		
enumeration	6																		
enumeration	7																		

### complexType **Soggetti\_Non\_Residenti\_Type**

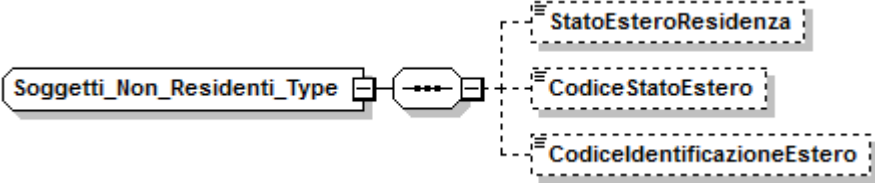
diagram	
namespace	urn:www.agenziaentrate.gov.it:specificheTecniche:sco:common
children	<a href="#">StatoEsteroResidenza</a> <a href="#">CodiceStatoEstero</a> <a href="#">CodiceIdentificazioneEstero</a>

### element **Soggetti\_Non\_Residenti\_Type/StatoEsteroResidenza**

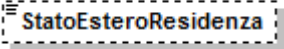
diagram					
namespace	urn:www.agenziaentrate.gov.it:specificheTecniche:sco:common				
type	<a href="#">DatoAN_Type</a>				
facets	<table border="1"> <thead> <tr> <th>Kind</th> <th>Value</th> </tr> </thead> <tbody> <tr> <td>pattern</td> <td>([0-9A-Z- &amp;quot;}{1}([ 0-9A-Z&amp;amp;] ' \"- \". , / ° \"\\( \\)\\ À É È Ì Ò Ù Û &amp;quot; \\\" \\+)*</td> </tr> </tbody> </table>	Kind	Value	pattern	([0-9A-Z- &quot;}{1}([ 0-9A-Z&amp;] ' \"- \". , / ° \"\\( \\)\\ À É È Ì Ò Ù Û &quot; \\\" \\+)*
Kind	Value				
pattern	([0-9A-Z- &quot;}{1}([ 0-9A-Z&amp;] ' \"- \". , / ° \"\\( \\)\\ À É È Ì Ò Ù Û &quot; \\\" \\+)*				

### element **Soggetti\_Non\_Residenti\_Type/CodiceStatoEstero**

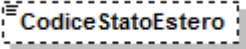
diagram	
namespace	urn:www.agenziaentrate.gov.it:specificheTecniche:sco:common



type	<a href="#">DatoAN_Type</a>
facets	Kind Value pattern ([0-9A-Z-]*)&quot;}{1}([ 0-9A-Z&amp;:] ' - \., / ^ \^\(\ \)\ À È É Ì Ò Ù Û &quot; \ \  \+)*

element **Soggetti\_Non\_Residenti\_Type/CodicelIdentificazioneEestero**

diagram	
namespace	urn:www.agenziaentrate.gov.it:specificheTecniche:sco:common
type	<a href="#">DatoAN_Type</a>
facets	Kind Value pattern ([0-9A-Z-]*)&quot;}{1}([ 0-9A-Z&amp;:] ' - \., / ^ \^\(\ \)\ À È É Ì Ò Ù Û &quot; \ \  \+)*

complexType **Soggetto\_Fiscale\_Type**

diagram	
namespace	urn:www.agenziaentrate.gov.it:specificheTecniche:sco:common
children	<a href="#">CodiceFiscale</a> <a href="#">Email</a> <a href="#">Telefono</a> <a href="#">Fax</a>

element **Soggetto\_Fiscale\_Type/CodiceFiscale**

diagram	
namespace	urn:www.agenziaentrate.gov.it:specificheTecniche:sco:common
type	<a href="#">DatoCF_Type</a>
facets	Kind Value pattern [0-9]{11}[A-Z]{6}[0-9LMNPQRSTUUV]{2}[A-Z]{1}[0-9LMNPQRSTUUV]{2}[A-Z]{1}[0-9LMNPQRSTUUV]{3}[A-Z]{1}

element **Soggetto\_Fiscale\_Type/Email**

diagram	
namespace	urn:www.agenziaentrate.gov.it:specificheTecniche:sco:common
type	<a href="#">DatoEM_Type</a>
facets	Kind Value pattern [a-zA-Z0-9_ %\-'&quot;?^~=]+@[a-zA-Z0-9.\-]+\.[a-zA-Z]{2,4}

element **Soggetto\_Fiscale\_Type/Telefono**

diagram	
namespace	urn:www.agenziaentrate.gov.it:specificheTecniche:sco:common
type	<a href="#">DatoTL_Type</a>
facets	Kind Value pattern [0-9]*

element **Soggetto\_Fiscale\_Type/Fax**

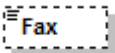
diagram	
namespace	urn:www.agenziaentrate.gov.it:specificheTecniche:sco:common
type	<a href="#">DatoTL_Type</a>
facets	Kind Value pattern [0-9]*

complexType **Tipo\_Dichiarazione\_Type**

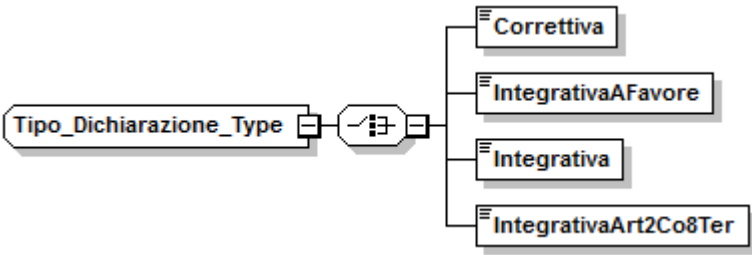
diagram	
namespace	urn:www.agenziaentrate.gov.it:specificheTecniche:sco:common
children	<a href="#">Correttiva</a> <a href="#">IntegrativaAFavore</a> <a href="#">Integrativa</a> <a href="#">IntegrativaArt2Co8Ter</a>

element **Tipo\_Dichiarazione\_Type/Correttiva**

diagram	
namespace	urn:www.agenziaentrate.gov.it:specificheTecniche:sco:common
type	<a href="#">DatoCB_Type</a>
facets	Kind Value pattern [01]

element **Tipo\_Dichiarazione\_Type/IntegrativaAFavore**

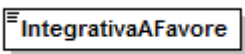
diagram	
namespace	urn:www.agenziaentrate.gov.it:specificheTecniche:sco:common

type	<a href="#">DatoCB_Type</a>
facets	Kind Value pattern [01]

#### element [Tipo\\_Dichiarazione\\_Type/Integrativa](#)

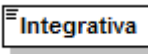
diagram	
namespace	urn:www.agenziaentrate.gov.it:specificheTecniche:sco:common
type	<a href="#">DatoCB_Type</a>
facets	Kind Value pattern [01]

#### element [Tipo\\_Dichiarazione\\_Type/IntegrativaArt2Co8Ter](#)

diagram	
namespace	urn:www.agenziaentrate.gov.it:specificheTecniche:sco:common
type	<a href="#">DatoCB_Type</a>
facets	Kind Value pattern [01]

#### complexType [Visto\\_Conformita\\_Type](#)

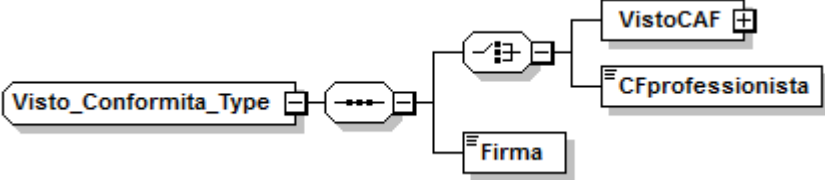
diagram	
namespace	urn:www.agenziaentrate.gov.it:specificheTecniche:sco:common
children	<a href="#">VistoCAF</a> <a href="#">CFprofessionista</a> <a href="#">Firma</a>

#### element [Visto\\_Conformita\\_Type/VistoCAF](#)

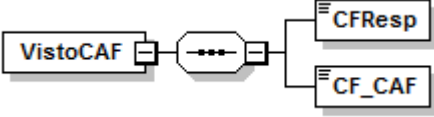
diagram	
namespace	urn:www.agenziaentrate.gov.it:specificheTecniche:sco:common
children	<a href="#">CFResp</a> <a href="#">CF_CAF</a>

element **Visto\_Conformita\_Type/VistoCAF/CFResp**

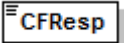
diagram					
namespace	urn:www.agenziaentrate.gov.it:specificheTecniche:sco:common				
type	<a href="#">DatoCF_Type</a>				
facets	<table border="1"> <thead> <tr> <th>Kind</th> <th>Value</th> </tr> </thead> <tbody> <tr> <td>pattern</td> <td>[0-9]{11}[A-Z]{6}[0-9LMNPQRSTUVWXYZ]{2}[A-Z]{1}[0-9LMNPQRSTUVWXYZ]{2}[A-Z]{1}[0-9LMNPQRSTUVWXYZ]{3}[A-Z]{1}</td> </tr> </tbody> </table>	Kind	Value	pattern	[0-9]{11}[A-Z]{6}[0-9LMNPQRSTUVWXYZ]{2}[A-Z]{1}[0-9LMNPQRSTUVWXYZ]{2}[A-Z]{1}[0-9LMNPQRSTUVWXYZ]{3}[A-Z]{1}
Kind	Value				
pattern	[0-9]{11}[A-Z]{6}[0-9LMNPQRSTUVWXYZ]{2}[A-Z]{1}[0-9LMNPQRSTUVWXYZ]{2}[A-Z]{1}[0-9LMNPQRSTUVWXYZ]{3}[A-Z]{1}				

element **Visto\_Conformita\_Type/VistoCAF/CF\_CAF**

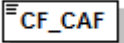
diagram					
namespace	urn:www.agenziaentrate.gov.it:specificheTecniche:sco:common				
type	<a href="#">DatoCN_Type</a>				
facets	<table border="1"> <thead> <tr> <th>Kind</th> <th>Value</th> </tr> </thead> <tbody> <tr> <td>pattern</td> <td>[0-9]{11}</td> </tr> </tbody> </table>	Kind	Value	pattern	[0-9]{11}
Kind	Value				
pattern	[0-9]{11}				

element **Visto\_Conformita\_Type/CFprofessionista**

diagram					
namespace	urn:www.agenziaentrate.gov.it:specificheTecniche:sco:common				
type	<a href="#">DatoCF_Type</a>				
facets	<table border="1"> <thead> <tr> <th>Kind</th> <th>Value</th> </tr> </thead> <tbody> <tr> <td>pattern</td> <td>[0-9]{11}[A-Z]{6}[0-9LMNPQRSTUVWXYZ]{2}[A-Z]{1}[0-9LMNPQRSTUVWXYZ]{2}[A-Z]{1}[0-9LMNPQRSTUVWXYZ]{3}[A-Z]{1}</td> </tr> </tbody> </table>	Kind	Value	pattern	[0-9]{11}[A-Z]{6}[0-9LMNPQRSTUVWXYZ]{2}[A-Z]{1}[0-9LMNPQRSTUVWXYZ]{2}[A-Z]{1}[0-9LMNPQRSTUVWXYZ]{3}[A-Z]{1}
Kind	Value				
pattern	[0-9]{11}[A-Z]{6}[0-9LMNPQRSTUVWXYZ]{2}[A-Z]{1}[0-9LMNPQRSTUVWXYZ]{2}[A-Z]{1}[0-9LMNPQRSTUVWXYZ]{3}[A-Z]{1}				

element **Visto\_Conformita\_Type/Firma**

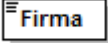
diagram					
namespace	urn:www.agenziaentrate.gov.it:specificheTecniche:sco:common				
type	<a href="#">DatoCB_Type</a>				
facets	<table border="1"> <thead> <tr> <th>Kind</th> <th>Value</th> </tr> </thead> <tbody> <tr> <td>pattern</td> <td>[01]</td> </tr> </tbody> </table>	Kind	Value	pattern	[01]
Kind	Value				
pattern	[01]				

complexType **Scelta2PerMille\_Type**

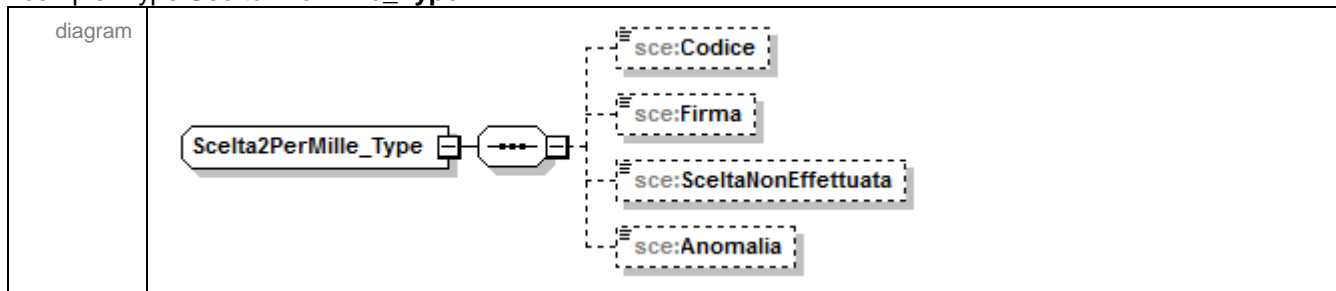

namespace	urn:www.agenziaentrate.gov.it:specificheTecniche:sco:sce
children	<a href="#">sce:Codice</a> <a href="#">sce:Firma</a> <a href="#">sce:SceltaNonEffettuata</a> <a href="#">sce:Anomalia</a>

#### element **Scelta2PerMille\_Type/Codice**

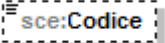
diagram					
namespace	urn:www.agenziaentrate.gov.it:specificheTecniche:sco:sce				
type	<a href="#">DatoAN_Type</a>				
facets	<table border="1"> <tr> <td>Kind</td> <td>Value</td> </tr> <tr> <td>pattern</td> <td>([0-9A-Z\-\&amp;quot;]{1}){([ 0-9A-Z&amp;amp;] \- \., / \^\(\ \)\À É È Ò Ù Û &amp;quot; \ \ /+)*</td> </tr> </table>	Kind	Value	pattern	([0-9A-Z\-\&quot;]{1}){([ 0-9A-Z&amp;] \- \., / \^\(\ \)\À É È Ò Ù Û &quot; \ \ /+)*
Kind	Value				
pattern	([0-9A-Z\-\&quot;]{1}){([ 0-9A-Z&amp;] \- \., / \^\(\ \)\À É È Ò Ù Û &quot; \ \ /+)*				

#### element **Scelta2PerMille\_Type/Firma**

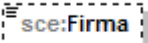
diagram					
namespace	urn:www.agenziaentrate.gov.it:specificheTecniche:sco:sce				
type	<a href="#">DatoCB_Type</a>				
facets	<table border="1"> <tr> <td>Kind</td> <td>Value</td> </tr> <tr> <td>pattern</td> <td>[01]</td> </tr> </table>	Kind	Value	pattern	[01]
Kind	Value				
pattern	[01]				

#### element **Scelta2PerMille\_Type/SceltaNonEffettuata**

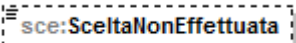
diagram					
namespace	urn:www.agenziaentrate.gov.it:specificheTecniche:sco:sce				
type	<a href="#">DatoCB_Type</a>				
facets	<table border="1"> <tr> <td>Kind</td> <td>Value</td> </tr> <tr> <td>pattern</td> <td>[01]</td> </tr> </table>	Kind	Value	pattern	[01]
Kind	Value				
pattern	[01]				

#### element **Scelta2PerMille\_Type/Anomalia**

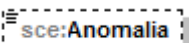
diagram													
namespace	urn:www.agenziaentrate.gov.it:specificheTecniche:sco:sce												
type	restriction of <a href="#">DatoN1_Type</a>												
facets	<table border="1"> <tr> <td>Kind</td> <td>Value</td> </tr> <tr> <td>pattern</td> <td>[1-9]</td> </tr> <tr> <td>enumeration</td> <td>1</td> </tr> <tr> <td>enumeration</td> <td>2</td> </tr> <tr> <td>enumeration</td> <td>3</td> </tr> <tr> <td>enumeration</td> <td>4</td> </tr> </table>	Kind	Value	pattern	[1-9]	enumeration	1	enumeration	2	enumeration	3	enumeration	4
Kind	Value												
pattern	[1-9]												
enumeration	1												
enumeration	2												
enumeration	3												
enumeration	4												

complexType **Scelta2PerMilleAssCult\_Type**

diagram	
namespace	urn:www.agenziaentrate.gov.it:specificheTecniche:sco:sce
type	extension of <a href="#">Firma_Type</a>
children	<a href="#">Firma</a> <a href="#">CodiceFiscale</a> <a href="#">sce:SceltaNonEffettuata</a> <a href="#">sce:Anomalia</a>

element **Scelta2PerMilleAssCult\_Type/SceltaNonEffettuata**

diagram					
namespace	urn:www.agenziaentrate.gov.it:specificheTecniche:sco:sce				
type	<a href="#">DatoCB_Type</a>				
facets	<table border="1"> <thead> <tr> <th>Kind</th> <th>Value</th> </tr> </thead> <tbody> <tr> <td>pattern</td> <td>[01]</td> </tr> </tbody> </table>	Kind	Value	pattern	[01]
Kind	Value				
pattern	[01]				

element **Scelta2PerMilleAssCult\_Type/Anomalia**

diagram													
namespace	urn:www.agenziaentrate.gov.it:specificheTecniche:sco:sce												
type	restriction of <a href="#">DatoN1_Type</a>												
facets	<table border="1"> <thead> <tr> <th>Kind</th> <th>Value</th> </tr> </thead> <tbody> <tr> <td>pattern</td> <td>[1-9]</td> </tr> <tr> <td>enumeration</td> <td>1</td> </tr> <tr> <td>enumeration</td> <td>2</td> </tr> <tr> <td>enumeration</td> <td>4</td> </tr> <tr> <td>enumeration</td> <td>5</td> </tr> </tbody> </table>	Kind	Value	pattern	[1-9]	enumeration	1	enumeration	2	enumeration	4	enumeration	5
Kind	Value												
pattern	[1-9]												
enumeration	1												
enumeration	2												
enumeration	4												
enumeration	5												

complexType **Scelta5PerMille\_Type**

diagram	
namespace	urn:www.agenziaentrate.gov.it:specificheTecniche:sco:sce
children	<a href="#">sce:SostegnoVolontariatoNonLucrative</a> <a href="#">sce:RicercaScientifica</a> <a href="#">sce:RicercaSanitaria</a> <a href="#">sce:BeniCulturaliPaesaggistici</a> <a href="#">sce:SostegnoSocialeComune</a> <a href="#">sce:SostegnoAssociazioniSportive</a> <a href="#">sce:SostegnoEntiAreeProtette</a> <a href="#">sce:SceltaNonEffetuata</a> <a href="#">sce:Anomalia</a> <a href="#">sce:FlagAnomaliaCFbeneficiario</a>

element **Scelta5PerMille\_Type/SostegnoVolontariatoNonLucrative**

diagram	
namespace	urn:www.agenziaentrate.gov.it:specificheTecniche:sco:sce
type	<a href="#">Firma_Type</a>
children	<a href="#">Firma</a> <a href="#">CodiceFiscale</a>

element **Scelta5PerMille\_Type/RicercaScientifica**

diagram	
namespace	urn:www.agenziaentrate.gov.it:specificheTecniche:sco:sce
type	<a href="#">Firma_Type</a>
children	<a href="#">Firma</a> <a href="#">CodiceFiscale</a>

element **Scelta5PerMille\_Type/RicercaSanitaria**

diagram	
namespace	urn:www.agenziaentrate.gov.it:specificheTecniche:sco:sce
type	<a href="#">Firma_Type</a>
children	<a href="#">Firma</a> <a href="#">CodiceFiscale</a>

element **Scelta5PerMille\_Type/BeniCulturaliPaesaggistici**

diagram	
namespace	urn:www.agenziaentrate.gov.it:specificheTecniche:sco:sce
type	<a href="#">Firma_Type</a>
children	<a href="#">Firma</a> <a href="#">CodiceFiscale</a>

element **Scelta5PerMille\_Type/SostegnoSocialeComune**

diagram	
namespace	urn:www.agenziaentrate.gov.it:specificheTecniche:sco:sce



children	<a href="#">sce:Firma</a>
----------	---------------------------

element **Scelta5PerMille\_Type/SostegnoSocialeComune/Firma**

diagram	
namespace	urn:www.agenziaentrate.gov.it:specificheTecniche:sco:sce
type	<a href="#">DatoCB_Type</a>
facets	Kind Value pattern [01]

element **Scelta5PerMille\_Type/SostegnoAssociazioniSportive**

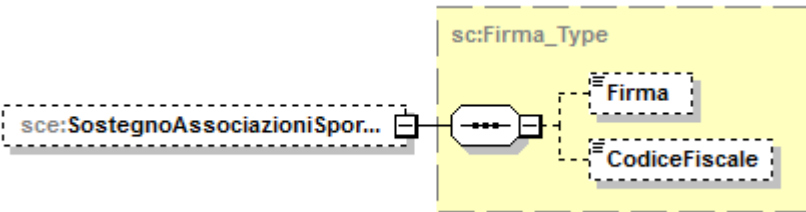
diagram	
namespace	urn:www.agenziaentrate.gov.it:specificheTecniche:sco:sce
type	<a href="#">Firma_Type</a>
children	<a href="#">Firma</a> <a href="#">CodiceFiscale</a>

element **Scelta5PerMille\_Type/SostegnoEntiAreeProtette**

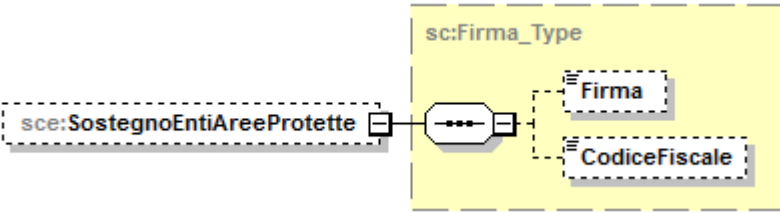
diagram	
namespace	urn:www.agenziaentrate.gov.it:specificheTecniche:sco:sce
type	<a href="#">Firma_Type</a>
children	<a href="#">Firma</a> <a href="#">CodiceFiscale</a>

element **Scelta5PerMille\_Type/SceltaNonEffettuata**

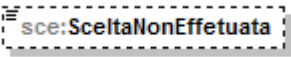
diagram	
namespace	urn:www.agenziaentrate.gov.it:specificheTecniche:sco:sce
type	<a href="#">DatoCB_Type</a>

facets	Kind	Value
	pattern	[01]

element **Scelta5PerMille\_Type/Anomalia**

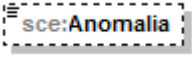
diagram															
namespace	urn:www.agenziaentrate.gov.it:specificheTecniche:sco:sce														
type	restriction of <a href="#">DatoN1_Type</a>														
facets	<table border="1"> <tr> <td>Kind</td> <td>Value</td> </tr> <tr> <td>pattern</td> <td>[1-9]</td> </tr> <tr> <td>enumeration</td> <td>1</td> </tr> <tr> <td>enumeration</td> <td>2</td> </tr> <tr> <td>enumeration</td> <td>3</td> </tr> <tr> <td>enumeration</td> <td>4</td> </tr> <tr> <td>enumeration</td> <td>5</td> </tr> </table>	Kind	Value	pattern	[1-9]	enumeration	1	enumeration	2	enumeration	3	enumeration	4	enumeration	5
Kind	Value														
pattern	[1-9]														
enumeration	1														
enumeration	2														
enumeration	3														
enumeration	4														
enumeration	5														

element **Scelta5PerMille\_Type/FlagAnomaliaCFbeneficiario**

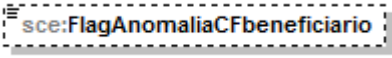
diagram					
namespace	urn:www.agenziaentrate.gov.it:specificheTecniche:sco:sce				
type	<a href="#">DatoCB_Type</a>				
facets	<table border="1"> <tr> <td>Kind</td> <td>Value</td> </tr> <tr> <td>pattern</td> <td>[01]</td> </tr> </table>	Kind	Value	pattern	[01]
Kind	Value				
pattern	[01]				

complexType **Scelta8PerMille\_Type**

diagram	
namespace	urn:www.agenziaentrate.gov.it:specificheTecniche:sco:sce
children	<a href="#">sce:Stato</a> <a href="#">sce:ChiesaCattolica</a> <a href="#">sce:UnioneChieseCristianeAvventiste7giorno</a> <a href="#">sce:AssembleeDiDioInItalia</a> <a href="#">sce:UnioneDelleChieseMetodisteValdesi</a> <a href="#">sce:ChiesaEvangelicaLuteranaInItalia</a> <a href="#">sce:UnioneComunitaEbraicheItaliane</a> <a href="#">sce:SacraArcidiocesiOrtodossaEsarcato</a> <a href="#">sce:ChiesaApostolicaItalia</a> <a href="#">sce:UnioneCristianaEvangelicaBattista</a> <a href="#">sce:UnioneBuddhistaitaliana</a> <a href="#">sce:UnioneInduistaitaliana</a> <a href="#">sce:IstitutoBuddistalbisg</a> <a href="#">sce:SceltaNonEffettuata</a> <a href="#">sce:Anomalia</a>

element **Scelta8PerMille\_Type/Stato**

diagram					
namespace	urn:www.agenziaentrate.gov.it:specificheTecniche:sco:sce				
type	<a href="#">DatoCB_Type</a>				
facets	<table border="1"> <tr> <td>Kind</td> <td>Value</td> </tr> <tr> <td>pattern</td> <td>[01]</td> </tr> </table>	Kind	Value	pattern	[01]
Kind	Value				
pattern	[01]				

element **Scelta8PerMille\_Type/ChiesaCattolica**

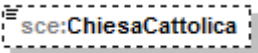
diagram	
namespace	urn:www.agenziaentrate.gov.it:specificheTecniche:sco:sce
type	<a href="#">DatoCB_Type</a>
facets	Kind Value pattern [01]

element **Scelta8PerMille\_Type/UnioneChieseCristianeAvventiste7giorno**

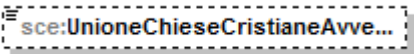
diagram	
namespace	urn:www.agenziaentrate.gov.it:specificheTecniche:sco:sce
type	<a href="#">DatoCB_Type</a>
facets	Kind Value pattern [01]

element **Scelta8PerMille\_Type/AssembleeDiDiolnItalia**

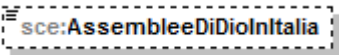
diagram	
namespace	urn:www.agenziaentrate.gov.it:specificheTecniche:sco:sce
type	<a href="#">DatoCB_Type</a>
facets	Kind Value pattern [01]

element **Scelta8PerMille\_Type/UnioneDelleChieseMetodisteValdesi**

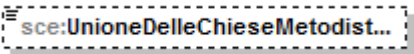
diagram	
namespace	urn:www.agenziaentrate.gov.it:specificheTecniche:sco:sce
type	<a href="#">DatoCB_Type</a>
facets	Kind Value pattern [01]

element **Scelta8PerMille\_Type/ChiesaEvangelicaLuteranaInItalia**

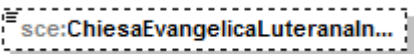
diagram	
namespace	urn:www.agenziaentrate.gov.it:specificheTecniche:sco:sce
type	<a href="#">DatoCB_Type</a>
facets	Kind Value pattern [01]

element **Scelta8PerMille\_Type/UnioneComunitaEbraicheItaliane**

diagram	 <code>sce:UnioneComunitaEbraicheItal...</code>				
namespace	urn:www.agenziaentrate.gov.it:specificheTecniche:sco:sce				
type	<a href="#">DatoCB_Type</a>				
facets	<table border="1"> <tr> <td>Kind</td> <td>Value</td> </tr> <tr> <td>pattern</td> <td>[01]</td> </tr> </table>	Kind	Value	pattern	[01]
Kind	Value				
pattern	[01]				

element **Scelta8PerMille\_Type/SacraArcidiocesiOrtodossaEsarcato**

diagram	 <code>sce:SacraArcidiocesiOrtodossa...</code>				
namespace	urn:www.agenziaentrate.gov.it:specificheTecniche:sco:sce				
type	<a href="#">DatoCB_Type</a>				
facets	<table border="1"> <tr> <td>Kind</td> <td>Value</td> </tr> <tr> <td>pattern</td> <td>[01]</td> </tr> </table>	Kind	Value	pattern	[01]
Kind	Value				
pattern	[01]				

element **Scelta8PerMille\_Type/ChiesaApostolicaItalia**

diagram	 <code>sce:ChiesaApostolicaItalia</code>				
namespace	urn:www.agenziaentrate.gov.it:specificheTecniche:sco:sce				
type	<a href="#">DatoCB_Type</a>				
facets	<table border="1"> <tr> <td>Kind</td> <td>Value</td> </tr> <tr> <td>pattern</td> <td>[01]</td> </tr> </table>	Kind	Value	pattern	[01]
Kind	Value				
pattern	[01]				

element **Scelta8PerMille\_Type/UnioneCristianaEvangelicaBattista**

diagram	 <code>sce:UnioneCristianaEvangelicaB...</code>				
namespace	urn:www.agenziaentrate.gov.it:specificheTecniche:sco:sce				
type	<a href="#">DatoCB_Type</a>				
facets	<table border="1"> <tr> <td>Kind</td> <td>Value</td> </tr> <tr> <td>pattern</td> <td>[01]</td> </tr> </table>	Kind	Value	pattern	[01]
Kind	Value				
pattern	[01]				

element **Scelta8PerMille\_Type/UnioneBuddhistaitaliana**

diagram	 <code>sce:UnioneBuddhistaitaliana</code>				
namespace	urn:www.agenziaentrate.gov.it:specificheTecniche:sco:sce				
type	<a href="#">DatoCB_Type</a>				
facets	<table border="1"> <tr> <td>Kind</td> <td>Value</td> </tr> <tr> <td>pattern</td> <td>[01]</td> </tr> </table>	Kind	Value	pattern	[01]
Kind	Value				
pattern	[01]				

element **Scelta8PerMille\_Type/UnioneInduistaltaliana**

diagram	 <b>sce:UnioneInduistaltaliana</b>
namespace	urn:www.agenziaentrate.gov.it:specificheTecniche:sco:sce
type	<a href="#">DatoCB_Type</a>
facets	Kind Value pattern [01]

element **Scelta8PerMille\_Type/IstitutoBuddistalbisg**

diagram	 <b>sce:IstitutoBuddistalbisg</b>
namespace	urn:www.agenziaentrate.gov.it:specificheTecniche:sco:sce
type	<a href="#">DatoCB_Type</a>
facets	Kind Value pattern [01]

element **Scelta8PerMille\_Type/SceltaNonEffettuata**

diagram	 <b>sce:SceltaNonEffettuata</b>
namespace	urn:www.agenziaentrate.gov.it:specificheTecniche:sco:sce
type	<a href="#">DatoCB_Type</a>
facets	Kind Value pattern [01]

element **Scelta8PerMille\_Type/Anomalia**

diagram	 <b>sce:Anomalia</b>
namespace	urn:www.agenziaentrate.gov.it:specificheTecniche:sco:sce
type	restriction of <a href="#">DatoN1_Type</a>
facets	Kind Value pattern [1-9] enumeration 1 enumeration 2 enumeration 3

complexType **Scelte\_Type**

diagram	
namespace	urn:www.agenziaentrate.gov.it:specificheTecniche:sco:sce
children	<a href="#">sce:Scelta5PerMille</a> <a href="#">sce:Scelta8PerMille</a> <a href="#">sce:Scelta2PerMille</a>

element **Scelte\_Type/Scelta5PerMille**

diagram	
namespace	urn:www.agenziaentrate.gov.it:specificheTecniche:sco:sce
type	<a href="#">sce:Scelta5PerMille_Type</a>
children	<a href="#">sce:SostegnoVolontariatoNonLucrative</a> <a href="#">sce:RicercaScientifica</a> <a href="#">sce:RicercaSanitaria</a> <a href="#">sce:BeniCulturaliPaesaggistici</a> <a href="#">sce:SostegnoSocialeComune</a> <a href="#">sce:SostegnoAssociazioniSportive</a> <a href="#">sce:SostegnoEntiAreeProtette</a> <a href="#">sce:SceltaNonEffettuata</a> <a href="#">sce:Anomalia</a> <a href="#">sce:FlagAnomaliaCFbeneficiario</a>

element **Scelte\_Type/Scelta8PerMille**

<p>diagram</p>	
<p>namespace</p>	<p>urn:www.agenziaentrate.gov.it:specificheTecniche:sco:sce</p>
<p>type</p>	<p><a href="#">sce:Scelta8PerMille_Type</a></p>
<p>children</p>	<p><a href="#">sce:Stato</a> <a href="#">sce:ChiesaCattolica</a> <a href="#">sce:UnioneChieseCristianeAvventiste7giorno</a> <a href="#">sce:AssembleeDiDioInItalia</a> <a href="#">sce:UnioneDelleChieseMetodisteValdesi</a> <a href="#">sce:ChiesaEvangelicaLuteranaInItalia</a> <a href="#">sce:UnioneComunitaEbraicheitaliane</a> <a href="#">sce:SacraArcidiocesiOrtodossaEsarcato</a> <a href="#">sce:ChiesaApostolicaItalia</a> <a href="#">sce:UnioneCristianaEvangelicaBattista</a> <a href="#">sce:UnioneBuddhistaitaliana</a> <a href="#">sce:UnioneInduistaitaliana</a> <a href="#">sce:IstitutoBuddistalbisg</a> <a href="#">sce:SceltaNonEffettuata</a> <a href="#">sce:Anomalia</a></p>



element **Scelte\_Type/Scelta2PerMille**

diagram	
namespace	urn:www.agenziaentrate.gov.it:specificheTecniche:sco:sce
type	<a href="#">sce:Scelta2PerMille_Type</a>
children	<a href="#">sce:Codice</a> <a href="#">sce:Firma</a> <a href="#">sce:SceltaNonEffettuata</a> <a href="#">sce:Anomalia</a>

simpleType **DatoAN\_Type**

namespace	urn:www.agenziaentrate.gov.it:specificheTecniche:common				
type	restriction of <b>xs:string</b>				
facets	<table border="1"> <tr> <td>Kind</td> <td>Value</td> </tr> <tr> <td>pattern</td> <td>([0-9A-Z\-\_]&amp;quot;){1}([ 0-9A-Z&amp;amp;:] ' \- \., / ^ \^\(\ \) À È É Ì Ò Ù Ú &amp;quot; \ \ / +)*</td> </tr> </table>	Kind	Value	pattern	([0-9A-Z\-\_]&quot;){1}([ 0-9A-Z&amp;:] ' \- \., / ^ \^\(\ \) À È É Ì Ò Ù Ú &quot; \ \ / +)*
Kind	Value				
pattern	([0-9A-Z\-\_]&quot;){1}([ 0-9A-Z&amp;:] ' \- \., / ^ \^\(\ \) À È É Ì Ò Ù Ú &quot; \ \ / +)*				

simpleType **DatoCB12\_Type**

namespace	urn:www.agenziaentrate.gov.it:specificheTecniche:common				
type	restriction of <b>xs:byte</b>				
facets	<table border="1"> <tr> <td>Kind</td> <td>Value</td> </tr> <tr> <td>pattern</td> <td>[10]{12}</td> </tr> </table>	Kind	Value	pattern	[10]{12}
Kind	Value				
pattern	[10]{12}				

simpleType **DatoCB\_Type**

namespace	urn:www.agenziaentrate.gov.it:specificheTecniche:common				
type	restriction of <b>xs:byte</b>				
facets	<table border="1"> <tr> <td>Kind</td> <td>Value</td> </tr> <tr> <td>pattern</td> <td>[01]</td> </tr> </table>	Kind	Value	pattern	[01]
Kind	Value				
pattern	[01]				

simpleType **DatoCF\_Type**

namespace	urn:www.agenziaentrate.gov.it:specificheTecniche:common				
type	restriction of <b>xs:string</b>				
facets	<table border="1"> <tr> <td>Kind</td> <td>Value</td> </tr> <tr> <td>pattern</td> <td>[0-9]{11}[A-Z]{6}[0-9LMNPQRSTUVWXYZ]{2}[A-Z]{1}[0-9LMNPQRSTUVWXYZ]{2}[A-Z]{1}[0-9LMNPQRSTUVWXYZ]{3}[A-Z]{1}</td> </tr> </table>	Kind	Value	pattern	[0-9]{11}[A-Z]{6}[0-9LMNPQRSTUVWXYZ]{2}[A-Z]{1}[0-9LMNPQRSTUVWXYZ]{2}[A-Z]{1}[0-9LMNPQRSTUVWXYZ]{3}[A-Z]{1}
Kind	Value				
pattern	[0-9]{11}[A-Z]{6}[0-9LMNPQRSTUVWXYZ]{2}[A-Z]{1}[0-9LMNPQRSTUVWXYZ]{2}[A-Z]{1}[0-9LMNPQRSTUVWXYZ]{3}[A-Z]{1}				

### simpleType DatoCN\_Type

namespace	urn:www.agenziaentrate.gov.it:specificheTecniche:common				
type	restriction of <b>xs:string</b>				
facets	<table border="1"> <tr> <td>Kind</td> <td>Value</td> </tr> <tr> <td>pattern</td> <td>[0-9]{11}</td> </tr> </table>	Kind	Value	pattern	[0-9]{11}
Kind	Value				
pattern	[0-9]{11}				

### simpleType DatoCP\_Type

namespace	urn:www.agenziaentrate.gov.it:specificheTecniche:common				
type	restriction of <b>xs:string</b>				
facets	<table border="1"> <tr> <td>Kind</td> <td>Value</td> </tr> <tr> <td>pattern</td> <td>[0-9]{5}</td> </tr> </table>	Kind	Value	pattern	[0-9]{5}
Kind	Value				
pattern	[0-9]{5}				

### simpleType DatoD6\_Type

namespace	urn:www.agenziaentrate.gov.it:specificheTecniche:common				
type	restriction of <b>xs:string</b>				
facets	<table border="1"> <tr> <td>Kind</td> <td>Value</td> </tr> <tr> <td>pattern</td> <td>((0[0-9]) (1[0-2]))((19 20)[0-9][0-9])</td> </tr> </table>	Kind	Value	pattern	((0[0-9]) (1[0-2]))((19 20)[0-9][0-9])
Kind	Value				
pattern	((0[0-9]) (1[0-2]))((19 20)[0-9][0-9])				

### simpleType DatoDA\_Type

namespace	urn:www.agenziaentrate.gov.it:specificheTecniche:common				
type	restriction of <b>xs:string</b>				
facets	<table border="1"> <tr> <td>Kind</td> <td>Value</td> </tr> <tr> <td>pattern</td> <td>(18 19 20)[0-9]{2}</td> </tr> </table>	Kind	Value	pattern	(18 19 20)[0-9]{2}
Kind	Value				
pattern	(18 19 20)[0-9]{2}				

### simpleType DatoDN\_Type

namespace	urn:www.agenziaentrate.gov.it:specificheTecniche:common				
type	restriction of <b>xs:string</b>				
facets	<table border="1"> <tr> <td>Kind</td> <td>Value</td> </tr> <tr> <td>pattern</td> <td>((([0-9]{12} [0-9]{11} [0-9]{10} [0-9]{9} [0-9]{8} [0-9]{7} [0-9]{6} [0-9]{5} [0-9]{4} [0-9]{3} [0-9]{2} [0-9] \d)) ((29)(02)([02468][048]00)) ((29)(02)([13579][26]00)) ((29)(02)([0-9][0-9][0][48])) ((29)(02)([0-9][0-9][2468][048])) ((29)(02)([0-9][0-9][13579][26]))))</td> </tr> </table>	Kind	Value	pattern	((([0-9]{12} [0-9]{11} [0-9]{10} [0-9]{9} [0-9]{8} [0-9]{7} [0-9]{6} [0-9]{5} [0-9]{4} [0-9]{3} [0-9]{2} [0-9] \d)) ((29)(02)([02468][048]00)) ((29)(02)([13579][26]00)) ((29)(02)([0-9][0-9][0][48])) ((29)(02)([0-9][0-9][2468][048])) ((29)(02)([0-9][0-9][13579][26]))))
Kind	Value				
pattern	((([0-9]{12} [0-9]{11} [0-9]{10} [0-9]{9} [0-9]{8} [0-9]{7} [0-9]{6} [0-9]{5} [0-9]{4} [0-9]{3} [0-9]{2} [0-9] \d)) ((29)(02)([02468][048]00)) ((29)(02)([13579][26]00)) ((29)(02)([0-9][0-9][0][48])) ((29)(02)([0-9][0-9][2468][048])) ((29)(02)([0-9][0-9][13579][26]))))				

### simpleType DatoDT\_Type

namespace	urn:www.agenziaentrate.gov.it:specificheTecniche:common				
type	restriction of <b>xs:string</b>				
facets	<table border="1"> <tr> <td>Kind</td> <td>Value</td> </tr> <tr> <td>pattern</td> <td>((([0-9]{12} [0-9]{11} [0-9]{10} [0-9]{9} [0-9]{8} [0-9]{7} [0-9]{6} [0-9]{5} [0-9]{4} [0-9]{3} [0-9]{2} [0-9] \d)) ((29)(02)([02468][048]00)) ((29)(02)([13579][26]00)) ((29)(02)([0-9][0-9][0][48])) ((29)(02)([0-9][0-9][2468][048])) ((29)(02)([0-9][0-9][13579][26]))))</td> </tr> </table>	Kind	Value	pattern	((([0-9]{12} [0-9]{11} [0-9]{10} [0-9]{9} [0-9]{8} [0-9]{7} [0-9]{6} [0-9]{5} [0-9]{4} [0-9]{3} [0-9]{2} [0-9] \d)) ((29)(02)([02468][048]00)) ((29)(02)([13579][26]00)) ((29)(02)([0-9][0-9][0][48])) ((29)(02)([0-9][0-9][2468][048])) ((29)(02)([0-9][0-9][13579][26]))))
Kind	Value				
pattern	((([0-9]{12} [0-9]{11} [0-9]{10} [0-9]{9} [0-9]{8} [0-9]{7} [0-9]{6} [0-9]{5} [0-9]{4} [0-9]{3} [0-9]{2} [0-9] \d)) ((29)(02)([02468][048]00)) ((29)(02)([13579][26]00)) ((29)(02)([0-9][0-9][0][48])) ((29)(02)([0-9][0-9][2468][048])) ((29)(02)([0-9][0-9][13579][26]))))				

### simpleType DatoEM\_Type

namespace	urn:www.agenziaentrate.gov.it:specificheTecniche:common
-----------	---

type	restriction of <b>xs:string</b>				
facets	<table border="1"> <tr> <td>Kind</td> <td>Value</td> </tr> <tr> <td>pattern</td> <td>[a-zA-Z0-9._%'\-&amp;quot;?^~=]+@[a-zA-Z0-9.\-]+\.[a-zA-Z]{2,4}</td> </tr> </table>	Kind	Value	pattern	[a-zA-Z0-9._%'\-&quot;?^~=]+@[a-zA-Z0-9.\-]+\.[a-zA-Z]{2,4}
Kind	Value				
pattern	[a-zA-Z0-9._%'\-&quot;?^~=]+@[a-zA-Z0-9.\-]+\.[a-zA-Z]{2,4}				

### simpleType **DatoGA\_Type**

namespace	urn:www.agenziaentrate.gov.it:specificheTecniche:common				
type	restriction of <b>xs:string</b>				
facets	<table border="1"> <tr> <td>Kind</td> <td>Value</td> </tr> <tr> <td>pattern</td> <td>[1-9]((1-9)[0-9]) ((12)[0-9][0-9]) (3[0-5][0-9]) (36[0-5])</td> </tr> </table>	Kind	Value	pattern	[1-9]((1-9)[0-9]) ((12)[0-9][0-9]) (3[0-5][0-9]) (36[0-5])
Kind	Value				
pattern	[1-9]((1-9)[0-9]) ((12)[0-9][0-9]) (3[0-5][0-9]) (36[0-5])				

### simpleType **DatoN1\_Type**

namespace	urn:www.agenziaentrate.gov.it:specificheTecniche:common				
type	restriction of <b>xs:string</b>				
facets	<table border="1"> <tr> <td>Kind</td> <td>Value</td> </tr> <tr> <td>pattern</td> <td>[1-9]</td> </tr> </table>	Kind	Value	pattern	[1-9]
Kind	Value				
pattern	[1-9]				

### simpleType **DatoNP\_Type**

namespace	urn:www.agenziaentrate.gov.it:specificheTecniche:common				
type	restriction of <b>xs:string</b>				
facets	<table border="1"> <tr> <td>Kind</td> <td>Value</td> </tr> <tr> <td>pattern</td> <td>[1-9]{1}[0-9]*</td> </tr> </table>	Kind	Value	pattern	[1-9]{1}[0-9]*
Kind	Value				
pattern	[1-9]{1}[0-9]*				

### simpleType **DatoNU\_Type**

namespace	urn:www.agenziaentrate.gov.it:specificheTecniche:common				
type	restriction of <b>xs:string</b>				
facets	<table border="1"> <tr> <td>Kind</td> <td>Value</td> </tr> <tr> <td>pattern</td> <td>(-[1-9]) ([1-9])[0-9]*</td> </tr> </table>	Kind	Value	pattern	(-[1-9]) ([1-9])[0-9]*
Kind	Value				
pattern	(-[1-9]) ([1-9])[0-9]*				

### simpleType **DatoPC\_Type**

namespace	urn:www.agenziaentrate.gov.it:specificheTecniche:common				
type	restriction of <b>xs:string</b>				
facets	<table border="1"> <tr> <td>Kind</td> <td>Value</td> </tr> <tr> <td>pattern</td> <td>[0-9]?[0-9](,\d{1,3})? 100,(0{1,3})?</td> </tr> </table>	Kind	Value	pattern	[0-9]?[0-9](,\d{1,3})? 100,(0{1,3})?
Kind	Value				
pattern	[0-9]?[0-9](,\d{1,3})? 100,(0{1,3})?				

### simpleType **DatoPI\_Type**

namespace	urn:www.agenziaentrate.gov.it:specificheTecniche:common				
type	restriction of <b>xs:string</b>				
facets	<table border="1"> <tr> <td>Kind</td> <td>Value</td> </tr> <tr> <td>pattern</td> <td>[0-7][0-9]{10}</td> </tr> </table>	Kind	Value	pattern	[0-7][0-9]{10}
Kind	Value				
pattern	[0-7][0-9]{10}				





	enumeration	30
	enumeration	31
	enumeration	32
	enumeration	33
	enumeration	34
	enumeration	35
	enumeration	36
	enumeration	37
	enumeration	38
	enumeration	39
	enumeration	40
	enumeration	41
	enumeration	42
	enumeration	43
	enumeration	44
	enumeration	45
	enumeration	50
	enumeration	51
	enumeration	52
	enumeration	53
	enumeration	54
	enumeration	55
	enumeration	56
	enumeration	57
	enumeration	58
	enumeration	59

#### simpleType **Sesso\_Type**

namespace	urn:www.agenziaentrate.gov.it:specificheTecniche:sco:common	
type	restriction of <a href="#">DatoAN_Type</a>	
facets	Kind	Value
	pattern	[(0-9A-Z-] &quot;){1}([ 0-9A-Z&amp;] ' \"- . . / ° √ \\( \\)À É Ê Ë Ì Ò Ù Ü &quot;; \\ \\ \\ +)*
	enumeration	M
	enumeration	F

#### simpleType **Situazione\_Type**

namespace	urn:www.agenziaentrate.gov.it:specificheTecniche:sco:common	
type	restriction of <a href="#">DatoNP_Type</a>	
facets	Kind	Value
	pattern	[1-9]{1}[0-9]*
	enumeration	1
	enumeration	2
	enumeration	3
	enumeration	4
	enumeration	5
	enumeration	6
	enumeration	7

#### simpleType **Stato\_Type**

namespace	urn:www.agenziaentrate.gov.it:specificheTecniche:sco:common	
type	restriction of <a href="#">DatoNP_Type</a>	
facets	Kind	Value
	pattern	[1-9]{1}[0-9]*
	enumeration	1
	enumeration	2
	enumeration	3

	enumeration 4
--	---------------

### simpleType **Eventi\_Ecc\_Type**

namespace	urn:www.agenziaentrato.gov.it:specificheTecniche:sco:common										
type	restriction of <b>xs:string</b>										
facets	<table border="1"> <thead> <tr> <th>Kind</th> <th>Value</th> </tr> </thead> <tbody> <tr> <td>enumeration</td> <td>1</td> </tr> <tr> <td>enumeration</td> <td>2</td> </tr> <tr> <td>enumeration</td> <td>3</td> </tr> <tr> <td>enumeration</td> <td>4</td> </tr> </tbody> </table>	Kind	Value	enumeration	1	enumeration	2	enumeration	3	enumeration	4
Kind	Value										
enumeration	1										
enumeration	2										
enumeration	3										
enumeration	4										

### simpleType **Estero**

namespace	urn:www.agenziaentrato.gov.it:specificheTecniche:common				
type	restriction of <b>xs:string</b>				
facets	<table border="1"> <thead> <tr> <th>Kind</th> <th>Value</th> </tr> </thead> <tbody> <tr> <td>enumeration</td> <td>EE</td> </tr> </tbody> </table>	Kind	Value	enumeration	EE
Kind	Value				
enumeration	EE				

### simpleType **PE\_Type**

namespace	urn:www.agenziaentrato.gov.it:specificheTecniche:common
type	union of ( <a href="#">ProvinciItaliane</a> , <a href="#">Estero</a> )

### simpleType **PN\_Type**

namespace	urn:www.agenziaentrato.gov.it:specificheTecniche:common
type	union of ( <a href="#">ProvinciItaliane</a> , <a href="#">ProvincieCroate</a> , <a href="#">Estero</a> , <a href="#">ProvincieSoppresse</a> )

### simpleType **PR\_Type**

namespace	urn:www.agenziaentrato.gov.it:specificheTecniche:common
type	union of ( <a href="#">ProvinciItaliane</a> )

### simpleType **ProvincieCroate**

namespace	urn:www.agenziaentrato.gov.it:specificheTecniche:common								
type	restriction of <b>xs:string</b>								
facets	<table border="1"> <thead> <tr> <th>Kind</th> <th>Value</th> </tr> </thead> <tbody> <tr> <td>enumeration</td> <td>FU</td> </tr> <tr> <td>enumeration</td> <td>PL</td> </tr> <tr> <td>enumeration</td> <td>ZA</td> </tr> </tbody> </table>	Kind	Value	enumeration	FU	enumeration	PL	enumeration	ZA
Kind	Value								
enumeration	FU								
enumeration	PL								
enumeration	ZA								

### simpleType **ProvinciItaliane**

namespace	urn:www.agenziaentrato.gov.it:specificheTecniche:common
-----------	---

type	restriction of <b>xs:string</b>	
facets	Kind	Value
	enumeration	AG
	enumeration	AL
	enumeration	AN
	enumeration	AO
	enumeration	AP
	enumeration	AQ
	enumeration	AR
	enumeration	AT
	enumeration	AV
	enumeration	BA
	enumeration	BG
	enumeration	BI
	enumeration	BL
	enumeration	BN
	enumeration	BO
	enumeration	BR
	enumeration	BS
	enumeration	BT
	enumeration	BZ
	enumeration	CA
	enumeration	CB
	enumeration	CE
	enumeration	CH
	enumeration	CI
	enumeration	CL
	enumeration	CN
	enumeration	CO
	enumeration	CR
	enumeration	CS
	enumeration	CT
	enumeration	CZ
	enumeration	EN
	enumeration	FC
	enumeration	FE
	enumeration	FG
	enumeration	FI
	enumeration	FM
	enumeration	FR
	enumeration	GE
	enumeration	GO
	enumeration	GR
	enumeration	IM
	enumeration	IS
	enumeration	KR
	enumeration	LC
	enumeration	LE
	enumeration	LI
enumeration	LO	
enumeration	LT	
enumeration	LU	
enumeration	MB	
enumeration	MC	
enumeration	ME	
enumeration	MI	
enumeration	MN	
enumeration	MO	
enumeration	MS	
enumeration	MT	
enumeration	NA	
enumeration	NO	
enumeration	NU	
enumeration	OG	
enumeration	OR	
enumeration	OT	
enumeration	PA	



enumeration	PC
enumeration	PD
enumeration	PE
enumeration	PG
enumeration	PI
enumeration	PN
enumeration	PO
enumeration	PR
enumeration	PT
enumeration	PU
enumeration	PV
enumeration	PZ
enumeration	RA
enumeration	RC
enumeration	RE
enumeration	RG
enumeration	RI
enumeration	RM
enumeration	RN
enumeration	RO
enumeration	SA
enumeration	SI
enumeration	SO
enumeration	SP
enumeration	SR
enumeration	SS
enumeration	SV
enumeration	TA
enumeration	TE
enumeration	TN
enumeration	TO
enumeration	TP
enumeration	TR
enumeration	TS
enumeration	TV
enumeration	UD
enumeration	VA
enumeration	VB
enumeration	VC
enumeration	VE
enumeration	VI
enumeration	VR
enumeration	VS
enumeration	VT
enumeration	VV

simpleType **ProvinciaSopresse**

namespace	urn:www.agenziaentrate.gov.it:specificheTecniche:common	
type	restriction of <b>xs:string</b>	
facets	Kind	Value
	enumeration	FO
	enumeration	PS