

ALLEGATO A

**Specifiche tecniche per la trasmissione
telematica Modello 730/2017**

INDICE

1	AVVERTENZE GENERALI	3
2	BREVI CENNI SUL LINGUAGGIO XML.....	3
3	CONTENUTO DELLA FORNITURA	5
3.1	GENERALITÀ.....	5
3.2	COERENZA DEI DATI DELLA DICHIARAZIONE	6
3.3	IL TRATTAMENTO DEL CODICE FISCALE	6
3.4	SOGGETTO CHE PRESTA L'ASSISTENZA FISCALE	7
4	TRASMISSIONE TELEMATICA DEL MOD. 730-4 DA PARTE DEI CAF, DEL PROFESSIONISTA ABILITATO O DI UNA ASSOCIAZIONE PROFESSIONALE ALL'AGENZIA DELLE ENTRATE E DESTINATO AI SOSTITUTI D'IMPOSTA.....	8
4.1	TRASMISSIONE TELEMATICA DEL MOD. 730-4: CASI PARTICOLARI.....	8
4.2	DATI MOD. 730-4 RESI DISPONIBILI DALL'AGENZIA DELLE ENTRATE AI SOSTITUTI O INTERMEDIARI	9
5	SPECIFICHE TECNICHE IN FORMATO XML.....	10
5.1	GENERALITÀ SPECIFICHE TECNICHE IN FORMATO XML.....	10
5.1.1	<i>Messaggio</i>	10
5.1.2	<i>Intestazione</i>	10
5.1.3	<i>Contenuto</i>	10
5.1.4	<i>Fornitura</i>	11
5.1.5	<i>Intestazione</i>	11
5.1.6	<i>Documento 730</i>	12
5.2	SPECIFICHE TECNICHE IN FORMATO XML	12

CONTENUTO E CARATTERISTICHE TECNICHE DEI DATI DELLE DICHIARAZIONI DEI REDDITI MODELLO 730/2017 DA INVIARE ALL'AMMINISTRAZIONE FINANZIARIA IN VIA TELEMATICA

1 AVVERTENZE GENERALI

I Sostituti d'imposta, i Centri di Assistenza Fiscale, i professionisti abilitati, le società e gli enti di grandi dimensioni, nonché gli intermediari abilitati, trasmettono i dati delle dichiarazioni dei Mod.730, all'**Agenzia delle Entrate** in via telematica.

Il contenuto e le caratteristiche della fornitura dei dati da trasmettere all'Agenzia delle Entrate in via telematica sono riportati nelle specifiche tecniche di seguito esposte.

Si precisa che una dichiarazione da inviare, i cui dati non sono conformi alle indicazioni delle presenti specifiche tecniche, verrà scartata.

Le modalità per la trasmissione dei dati in via telematica sono stabilite con il decreto del 31 luglio 1998 (pubblicato nella G.U. del 12 agosto 1998, n. 187) e successive modificazioni.

2 Brevi cenni sul linguaggio XML

L'Agenzia delle Entrate ha scelto di adottare, per la definizione della fornitura relativa alle dichiarazioni 730 2017, il linguaggio XML (eXtensible Markup Language).

L'XML è un metalinguaggio, ossia una "grammatica", per la definizione di documenti da gestire con strumenti informatici.

Per "grammatica" si intende l'insieme standard di definizioni e di regole sintattiche mediante le quali la struttura logica di un documento viene tradotta in una corrispondente struttura fisica, composta di elementi sintattici chiamati **tag**, ossia sequenze di caratteri delimitate dai segni '<' e '>'.

Concretamente, un file XML è un file di testo costituito da diversi **elementi** individuati dai **tag**, ciascuno dei quali identifica un componente logico del documento.

Gli **elementi** sono organizzati secondo una **struttura gerarchica**: ciascun **elemento** può infatti contenere altri elementi (**sottoelementi**) oppure del testo. L'elemento principale della struttura "ad albero" così ottenuta è denominato **radice (root element)**.

Agli **elementi** possono essere associate altre informazioni che ne descrivono le proprietà, tali informazioni sono chiamate **attributi**.

La modellazione della fornitura delle dichiarazioni 730/2017 è stata realizzata introducendo la radice denominata Messaggio, all'interno della quale sono stati individuati i due sottoelementi Intestazione e Contenuto.

L'elemento Intestazione espone il codice fiscale del soggetto responsabile dell'invio telematico, l'elemento Contenuto definisce al suo interno una Fornitura astratta che, nel caso del modello 730 2017, assume le caratteristiche di quella ad esso relativa e descritta nel paragrafo 5. L'elemento Contenuto espone l'attributo codiceFornitura che per il suddetto modello deve essere impostato al valore 73017.

Nel paragrafo 5 vengono fornite ulteriori indicazioni relative agli elementi sopra citati.

La struttura della fornitura xml è descritta, mediante l'**XML Schema**, in uno specifico documento (**schema document**), identificato dall'estensione "xsd". Il file XSD (XML Schema Definition) delinea il contenuto della fornitura definendone gli elementi ed evidenziandone attributi e relazioni reciproche.

In particolare, lo **schema** relativo alla fornitura xml identifica tre diverse tipologie di componenti: elementi di significato generale, ossia indipendenti dal tipo di documento contenuto nella fornitura stessa, elementi che rappresentano i componenti logici di una generica dichiarazione ed elementi che costituiscono, più specificamente, la struttura di una dichiarazione Modello 730.

Ciascuna delle suddette tipologie di componenti individua un "dominio di nomi" (**namespace**), un ambito nel quale gli elementi sono univoci ed hanno significato omogeneo.

Concretamente, lo schema relativo alla fornitura 730 si compone di un insieme di documenti xsd, associati ai tre diversi namespace, nei quali sono definiti, oltre agli elementi della fornitura, anche i tipi di dati ad essi associati ed alcuni elenchi di codici predefiniti previsti per gli elementi della dichiarazione.

3 CONTENUTO DELLA FORNITURA

3.1 Generalità

La fornitura oggetto della trasmissione telematica deve essere conforme alle specifiche dell'eXtensible Markup Language (XML) 1.0 (raccomandazione WC3 10 febbraio 1998) e deve essere codificata secondo la codifica UTF-8.

Il contenuto della fornitura xml, relativa al Modello 730/2017, deve inoltre soddisfare la sintassi descritta nel file XSD denominato “**fornitura730_2017_v1.xsd**”, allegato al presente documento.

Il suddetto schema definisce la struttura della fornitura xml, delineando gli elementi permessi, i loro attributi, i tipi di dati ad essi associati e la relazione gerarchica tra gli elementi stessi.

La procedura distribuita dall'Agenzia delle Entrate esegue una prima fase di **validazione** della fornitura, ossia di verifica che il file sia conforme allo schema ad esso associato ed una successiva fase di **controllo**, nella quale esamina la correttezza dei dati indicati applicando regole specifiche per ciascun elemento.

L'esito negativo della validazione determina lo scarto dell'intera fornitura.

I diagnostici generati in fase di **controllo** possono avere una diversa gravità a seconda dell'elemento interessato e possono determinare lo scarto della singola dichiarazione o dell'intera fornitura.

3.2 Coerenza dei dati della dichiarazione

Nella “*Circolare per la liquidazione ed il controllo del modello 730/2017*” trovano esposizione anche le regole che definiscono l’accoglimento o meno della dichiarazione 730/2017 da trasmettere in via telematica all’Agenzia delle Entrate. In particolare sono riportati, oltre a tutti i criteri per la puntuale determinazione delle imposte, anche i criteri di accoglimento della dichiarazione. Tali criteri, sono suddivisi in confermabili e bloccanti. La dichiarazione 730/2017 predisposta con le modalità previste nelle presenti specifiche tecniche XML, deve essere conforme ai criteri sopra citati. La non conformità della dichiarazione ai suddetti criteri, determina il non accoglimento della stessa in sede di trasmissione telematica.

3.3 Il trattamento del Codice Fiscale

I codici fiscali riportati nelle dichiarazioni mod. 730/2017 devono essere formalmente corretti. Si precisa che in sede di accoglimento delle dichiarazioni trasmesse in via telematica, costituirà oggetto di scarto della dichiarazione stessa l’indicazione di un **codice fiscale del contribuente** che, anche se formalmente corretto, non risulti registrato presso l’Anagrafe Tributaria.

Nel caso di omocodia del codice fiscale del contribuente risolta dall’Agenzia delle Entrate con l’attribuzione di un nuovo codice fiscale, l’indicazione in dichiarazione del precedente codice fiscale (omocodice) comporta, in sede di accoglimento delle dichiarazioni trasmesse in via telematica, lo scarto della dichiarazione.

Il codice fiscale del rappresentante deve essere registrato in Anagrafe Tributaria; la non registrazione comporta lo scarto della dichiarazione in fase di accettazione **senza possibilità di conferma della stessa.**

Il codice fiscale del sostituto d’imposta che effettuerà le operazioni di conguaglio deve essere registrato in Anagrafe Tributaria; la non registrazione comporta lo scarto della dichiarazione in fase di accettazione senza possibilità di conferma della stessa.

Anche ciascun codice fiscale indicato nel prospetto dei familiari a carico deve essere registrato in Anagrafe Tributaria; la non registrazione comporta lo scarto della dichiarazione in fase di accettazione senza possibilità di conferma della stessa.

3.4 Soggetto che presta l'assistenza fiscale

L'indicazione del soggetto che ha prestato l'assistenza fiscale con i relativi dati identificativi e l'indicazione della data di consegna del mod. 730/2017 sono obbligatori. Si rimanda alle istruzioni fornite nella circolare di liquidazione al paragrafo "Dati assistenza fiscale da riportare nel flusso telematico".

4 TRASMISSIONE TELEMATICA DEL MOD. 730-4 DA PARTE DEI CAF, DEL PROFESSIONISTA ABILITATO O DI UNA ASSOCIAZIONE PROFESSIONALE ALL'AGENZIA DELLE ENTRATE E DESTINATO AI SOSTITUTI D'IMPOSTA

Il D.M. n. 164 del 1999, prevede che i soggetti che prestano l'assistenza fiscale trasmettano i risultati finali delle dichiarazioni relative al mod. 730 (mod. 730-4) non più direttamente ai sostituti d'imposta ma all'Agenzia delle Entrate la quale provvederà successivamente ad inviarli telematicamente al sostituto d'imposta.

Da quest'anno, in sede di trasmissione telematica delle dichiarazioni relative al modello 730/2017, i dati relativi al mod. 730-4 dovranno essere sempre allegati ai dati della dichiarazione mod. 730/2017 indipendentemente dalla circostanza che il sostituto d'imposta sia o meno abilitato a ricevere i dati del mod. 730-4 (presentazione comunicazione CSO/CT) salvo quanto precisato nel successivo paragrafo "Trasmissione telematica del mod. 730-4: casi particolari".

Si precisa inoltre che, a differenza di quanto previsto in precedenza, i dati del modello 730-4 devono essere allegati alla dichiarazione 730 anche nel caso di assistenza fiscale prestata dal sostituto d'imposta.

In sede di accoglimento delle dichiarazioni trasmesse in via telematica, costituisce oggetto di controllo la coerenza dei dati contenuti nel mod. 730-4 con quelli presenti nel modello 730/2017. Eventuali anomalie riscontrate determinano lo scarto della dichiarazione.

Ai sostituti d'imposta i dati relativi al mod. 730-4 saranno resi disponibili presso la sede telematica comunicata con l'apposito modello di comunicazione trasmesso all'Agenzia delle Entrate.

4.1 Trasmissione telematica del mod. 730-4: Casi particolari

Nel caso in cui dalla liquidazione della dichiarazione (mod. 730 ordinario ovvero mod. 730 integrativo), risulti che non ci sia alcun importo da trattenere o da rimborsare a cura del sostituto d'imposta, i dati relativi al mod. 730-4 non devono essere riportati nel tracciato telematico della dichiarazione 730 2017 e deve essere impostato ad "1" l'apposito campo (**FlagAssenzaDati730-4**) previsto nelle presenti specifiche tecniche del modello 730/2017. La non corretta impostazione della suddetta casella determina lo scarto della dichiarazione 730/2017.

Si precisa che nel caso di un **modello 730 rettificativo**, qualora dalla liquidazione della dichiarazione risulti che non ci sia alcun importo da trattenere o da rimborsare a cura del sostituto d'imposta, i dati relativi al mod. 730-4 devono comunque essere riportati nel tracciato telematico della dichiarazione 730/2017. In tal caso risulteranno pertanto compilati i soli dati relativi al soggetto che ha prestato l'assistenza fiscale, al sostituto d'imposta, al contribuente con l'assenza di tutti i dati contabili.

4.2 Dati mod. 730-4 resi disponibili dall’Agenzia delle Entrate ai Sostituti o Intermediari

I dati relativi al mod. 730-4 saranno resi disponibili da parte dell’Agenzia delle Entrate ai sostituti d’imposta ovvero agli intermediari da questi incaricati in conformità alle istruzioni contenute nelle presenti specifiche tecniche relative al mod. 730/2017 nella sezione riferita alla “**Fornitura 730-4**”. La sintassi della fornitura relativa ai mod. 730-4 è descritta nel file XSD denominato “**fornitura734_2017_v1.xsd**” la cui documentazione è allegata al presente documento.

5 Specifiche tecniche in formato XML

5.1 Generalità Specifiche tecniche in formato XML

5.1.1 Messaggio

Lo schema prevede la definizione di un elemento principale (radice della struttura) denominato **Messaggio**. Esso è un elemento xml di tipo complesso contenente la sequenza ordinata di due sotto-elementi obbligatori **Intestazione** e **Contenuto** dei quali può essere presente una sola occorrenza.

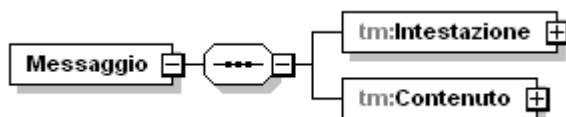

5.1.2 Intestazione

L'elemento xml denominato **Intestazione** è un elemento obbligatorio di tipo complesso **Intestazione_Type** illustrato nella figura seguente.

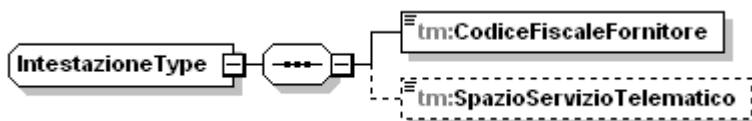

L'elemento **Intestazione** deve contenere i seguenti sottoelementi semplici rispettando la sequenza indicata:

CodiceFiscaleFornitore

E' un elemento obbligatorio di tipo semplice che deve esporre il codice fiscale del soggetto responsabile della trasmissione telematica. Il dato è di tipo alfanumerico e può essere composto, in alternativa, o da 11 caratteri numerici (nel caso in cui il codice fiscale si riferisca ad una persona giuridica) oppure da 16 caratteri alfanumerici maiuscoli (nel caso in cui il codice fiscale sia relativo ad una persona fisica).

SpazioServizioTelematico

E' un elemento opzionale che deve esporre alcune informazioni riservate al servizio telematico. Tale elemento, pertanto, viene creato esclusivamente da funzionalità predisposte dal servizio telematico. Il dato in esso contenuto è di tipo alfanumerico.

5.1.3 Contenuto

L'elemento xml denominato **Contenuto** deve contenere, al suo interno, i dati identificativi della fornitura ai fini della trasmissione telematica. Pertanto è un elemento di tipo complesso **Contenuto_Type** illustrato nella figura successiva.

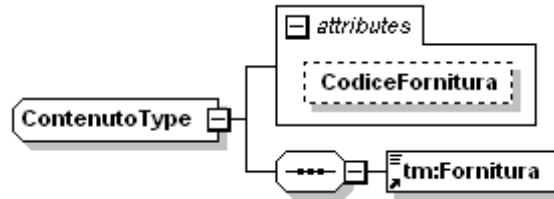

In particolare tale elemento prevede un attributo denominato **CodiceFornitura** ed un sottoelemento **Fornitura**.

L'attributo **CodiceFornitura** identifica il codice della fornitura e serve per individuare in maniera univoca la tipologia di documento contenuto nel file. Tale elemento di tipo semplice è obbligatorio e deve essere composto da 5 caratteri alfanumerici maiuscoli. Per il modello 730/2017 deve assumere il seguente valore “**73017**”.

L'elemento xml denominato **Fornitura**, invece, è un elemento obbligatorio di tipo astratto che deve essere, di volta in volta, implementato dai diversi tipi di fornitura XML.

Comunicazione dati rettificati caf o professionisti (Codice Fornitura “73017”)

L'art. 6 (visto di conformità) del decreto legislativo 21 novembre 2014, n. 175, ha apportato delle modifiche all'art. 39 del decreto legislativo 9 luglio 1997, n. 241. In particolare, se il Caf o il professionista appone un visto di conformità infedele, è tenuto al pagamento di una somma pari all'importo dell'imposta, della sanzione e degli interessi che sarebbero stati richiesti al contribuente a seguito dei controlli formali da parte dell'Agenzia delle entrate, sempre che il visto infedele non sia stato indotto dalla condotta dolosa del contribuente. Se entro il 10 novembre dell'anno in cui la violazione è stata commessa il Caf o il professionista trasmette una dichiarazione rettificativa del contribuente oppure, se il contribuente non intende presentare la nuova dichiarazione, trasmette una comunicazione dei dati relativi alla rettifica, la somma dovuta dal Caf o dal professionista è pari all'importo della sola sanzione. **La trasmissione delle informazioni relative ai dati rettificati deve avvenire con modalità analoghe a quelle previste per la trasmissione telematica dei dati del modello 730 2017 in conformità alle indicazioni fornite nella Circolare di liquidazione del modello 730 2017 ed impostando l'attributo CodiceFornitura al valore “73017”.**

5.1.4 Fornitura

L'elemento denominato **Fornitura** ed è un elemento xml complesso contenente la sequenza ordinata di due sottoelementi: **Intestazione** e **Documento730**, del quale possono essere presenti una o più occorrenze.

5.1.5 Intestazione

L'elemento Intestazione contiene i dati del soggetto responsabile dell'invio telematico (fornitore):

- TipoFornitore - è l'elemento che definisce la tipologia del soggetto che esegue la trasmissione, è di tipo DatoNP_Type.

- SpazioUtente - è un elemento opzionale il cui contenuto può essere liberamente definito dall'utente ed è di tipo DatoAN_Type

5.1.6 Documento 730

L'elemento Documento 730 è di tipo Documento_730_Type. Il tipo Documento_730_Type definisce l'attributo obbligatorio denominato **identificativo**. Tale attributo ha lo scopo di identificare univocamente il generico documento nell'ambito della fornitura ed è di tipo DatoNP_Type.

Controlli previsti per l'attributo:



Validazione: la lunghezza massima prevista è di 5 caratteri.

Controllo bloccante: il valore assunto dall'attributo deve essere univoco all'interno dell'intera fornitura.

5.2 Specifiche tecniche in formato XML

Di seguito viene descritto il contenuto informativo dei dati della fornitura da trasmettere in via telematica (**fornitura730_2017_v1.xsd e fornitura734_2017_v1.xsd**).

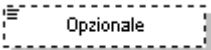
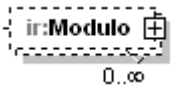
Per la rappresentazione grafica della struttura gerarchica sono utilizzati alcuni simboli grafici descritti nella seguente tabella:

	Elemento obbligatorio
	Elemento opzionale
	Elemento ripetuto 0 o più volte
	Sequenza ordinata di elementi (Sequence)
	Alternativa tra due o più elementi (Choice)

Schema [fornitura730_2017_v1.xsd](#)

schema location: [fornitura730_2017_v1.xsd](#)
attribute form default: **unqualified**
element form default: **qualified**
targetNamespace: **urn:www.agenziaentrate.gov.it:specificheTecniche:sco:730**

Elements
[Fornitura](#)

schema location: [documento730_2017_v1.xsd](#)
attribute form default: **unqualified**
element form default: **qualified**
targetNamespace: **urn:www.agenziaentrate.gov.it:specificheTecniche:sco:730**

Elements

[Documento730](#)

Complex types

[Accounti Altri Dati Type](#)
[Accounti Irpef Anno Imposta Type](#)
[Accounti Ritenute Type](#)
[Accounti Compensati Intern Type](#)
[Acquisto Costruzione Abit Type](#)
[Addizionali Type](#)
[Altre Detrazioni Type](#)
[Altre Ritenute Type](#)
[Altre Spese Type](#)
[Altri Dati Type](#)
[Altri Oneri Type](#)
[Altri Redditi Ass Lav Type](#)
[Altri Redditi Diversi Detr Type](#)
[Altri Redditi Diversi Type](#)
[Altri Redditi Lavoro Autonomo Type](#)
[Altri Redditi Type](#)
[Altri Redditi Utili Type](#)
[Annotazione Type](#)
[Assegno Coniuge Type](#)
[Bonus Irpef Type](#)
[Casella Acconto Type](#)
[Cedolare Secca Type](#)
[Comunicazione Amministratore Type](#)
[Conquaglio Type](#)
[Contributi Previdenza Complementare Type](#)
[Contributo Solidarieta Type](#)
[Cred Erogazione Cultura Type](#)
[Cred Imp Estero Type](#)
[Crediti F24 Type](#)
[Crediti Imposta Altri Sisma Abruzzo Type](#)

[Crediti Imposta Fabbicati Type](#)
[Crediti Imposta Fondi Pensione Type](#)
[Crediti Imposta Redditi Esteri Type](#)
[Crediti Imposta Type](#)
[Credito Erogazioni Cultura Type](#)
[Credito Erogazioni Scuola Type](#)
[Credito Immobile Sisma Abruzzo Type](#)
[Credito Incremento Occupazione Type](#)
[Credito Negoziazione Type](#)
[Credito Stato Type](#)
[Credito Type](#)
[Credito Videosorveglianza Type](#)
[Dati 730 Integrativo Type](#)
[Dati Altre Detrazioni Modulo Type](#)
[Dati Altre Detrazioni Type](#)
[Dati Associazioni Professionale Type](#)
[Dati CAF Type](#)
[Dati Catastali Recupero Patrimonio Edilizio Type](#)
[Dati Catastali Type](#)
[Dati Condominio Type](#)
[Dati Coniuge Type](#)
[Dati Contabili Type](#)
[Dati Contratto Type](#)
[Dati Familiare Type](#)
[Dati Fornitore Type](#)
[Dati Nascita PF Type](#)
[Dati Primo Figlio Type](#)
[Dati Professionista Type](#)
[Dati Registrazione Accatastamento Recupero Patrimonio Edilizio Type](#)
[Dati Rettificati Type](#)
[Debito Type](#)
[Deduzioni Modulo Type](#)
[Deduzioni Type](#)
[Detrazione Crediti Type](#)
[Detrazioni Canoni Locazione Type](#)
[Detrazioni Modulo Type](#)
[Detrazioni Type](#)
[Dichiarazione Con Type](#)
[Dichiarazione Dich Type](#)
[Documento 730-4](#)
[Documento 730 Type](#)
[Domanda Accatastamento Type](#)
[Domicilio Fiscale Acconto Type](#)
[Domicilio Fiscale Type](#)
[Domicilio Sogg Ass Fiscale Type](#)
[Eccedenze Oltre Anno Type](#)

[Eccedenze Type](#)
[Elemento Integrativo Type](#)
[Esenzione Add Comunale Type](#)
[Esenzione Bonus Type](#)
[Esito Liquidazione Type](#)
[Fabbricato Agev Type](#)
[Fabbricato Ord Type](#)
[Familiari Type](#)
[Firma Dichiarazione Type](#)
[Fondo Pensione Dipendenti Pubblici Type](#)
[Frontespizio 730 Type](#)
[Frontespizio Con Type](#)
[Frontespizio Dich Type](#)
[Fuori Assistenza Type](#)
[Giorni Percentuale Type](#)
[Importi Rimborsare 730-4 Integrativo Type](#)
[Importi Rimborsare 730-4 Type](#)
[Importi Trattenere 730-4 Type](#)
[Importo 730-4](#)
[Imposta Lorda Type](#)
[Imposta Netta Type](#)
[Imposte Rimborsate Type](#)
[Inquilini Abitazione Principale Type](#)
[Intervento Recupero Patrimonio Edilizio Type](#)
[Intervento Risparmio Energetico Type](#)
[Iva Acquisto Abitazione Type](#)
[Lavoro Dipendente Type](#)
[Misura Acconti Type](#)
[Mod730 Integrativo Type](#)
[Modulo Altri Redditi Type](#)
[Modulo Annotazioni Type](#)
[Modulo Comunicazione Type](#)
[Modulo Crediti Imposta Type](#)
[Modulo Credito Negoziazione Type](#)
[Modulo Fabbricato Type](#)
[Modulo Familiari Type](#)
[Modulo Lavoro Dip Type](#)
[Modulo Oneri Type](#)
[Modulo PL Type](#)
[Modulo Terreno Type](#)
[Oneri Non Abbattuti Type](#)
[Oneri Type](#)
[Opzione Produttivita Type](#)
[Periodo Di Lavoro Type](#)
[Pignoramento Type](#)
[Premi Risultato Modulo Type](#)

[Premi Risultato Type](#)
[Primo Modulo Acconti Ritenute Type](#)
[Primo Modulo Crediti Imposta Type](#)
[Primo Modulo Familiari Type](#)
[Primo Modulo Lavoro Dip Type](#)
[Primo Modulo Oneri Type](#)
[Primo Modulo PL Type](#)
[Prospetto Annotazioni Type](#)
[Prospetto Liquidazione Type](#)
[Prospetto Type](#)
[Quadro I Type](#)
[Quadro K Type](#)
[Rappresentante Type](#)
[Redditi Capitale Type](#)
[Redditi Eredi Legatari Type](#)
[Redditi Fabbricati Type](#)
[Redditi Lavoro Dip Type](#)
[Redditi Ritenute Spese Type](#)
[Redditi Ritenute Type](#)
[Redditi Tassazione Separata Type](#)
[Redditi Terreni Type](#)
[Reddito Erede Type](#)
[Residenza Anagrafica 730 Type](#)
[Residenza Rappresentante Type](#)
[Residenza Type](#)
[Residuo Credito Compens AnnoImposta Type](#)
[Residuo Credito Compens Type](#)
[Residuo Fabbricati Type](#)
[Restituzione Somme Type](#)
[Rettifica Type](#)
[Riepilogo Redditi Type](#)
[Ritenute Acconti Sospesi Type](#)
[Ritenute Lavoro Dip Type](#)
[Sezione Altri Redd Type](#)
[Sezione Dati Catastali Recupero Patrimonio Edilizio Type](#)
[Soggetto Assistenza Fiscale Doc Type](#)
[Soggetto Fiscale 730 Type](#)
[Soglie Esenzione Type](#)
[Sostituto Type](#)
[Spese Arredo Giovani Coppie Type](#)
[Spese Arredo Type](#)
[Spese Leasing Type](#)
[Spese Rateizzate Anni Precedenti Type](#)
[Spese Rateizzate Type](#)
[Tassazione Separata Type](#)
[Terreno Type](#)

Versamenti F24 Type

schema location: [intestazione730_2017_v1.xsd](#)
attribute form default: **unqualified**
element form default: **qualified**
targetNamespace: **urn:www.agenziaentrate.gov.it:specificheTecniche:sco:730**

Elements Complex types
[Intestazione](#) [Intestazione 730 Type](#)

schema location: [types730_2017_v1.xsd](#)
attribute form default: **unqualified**
element form default: **qualified**
targetNamespace: **urn:www.agenziaentrate.gov.it:specificheTecniche:sco:730**

Simple types

[Anno Anticipazione Fondo Pensione Type](#)
[Anno Recupero Patrimonio Edilizio Type](#)
[Anno Risparmio Energetico Type](#)
[Casi Particolari Fabbricato Type](#)
[Casi Particolari Risp Ener Type](#)
[Casi Particolari Terreni Type](#)
[Codice Altre Detrazioni Type](#)
[Codice Altre Spese Type](#)
[Codice Altri Oneri Type](#)
[Codice Canone Type](#)
[Codice Evento Eccezionale Type](#)
[Codice Spese Rateizzate Anni Precedenti Type](#)
[Codice Spese Rateizzate Type](#)
[Fabbricato Agev Numero Rigo Type](#)
[Indeterminato Determinato Type](#)
[Integrativo Type](#)
[Mesi Type](#)
[Numero Rata Risparmio Energetico Type](#)
[Periodo Spese Ristrutturazione Type](#)
[Rate10 Type](#)
[Rate Risparmio Energetico Type](#)
[Reintegro Totale Parziale Type](#)
[Rettificativo Type](#)
[Ripart Risparmio Energetico Type](#)
[Serie Registrazione Contratto Type](#)
[Stato Civile Type](#)
[Terreni Urbano Type](#)
[Tipo Inquilino Type](#)
[Tipo Intervento Type](#)
[Tipo Reddito Da1a12 Type](#)
[Tipo Reddito Da1a3 Type](#)
[Tipo Reddito Da1a4 Type](#)
[Tipo Reddito Da1a8 Type](#)
[Tipo Reddito Da1a9 Type](#)
[Tipologia Soggetto Ass Fisc Type](#)
[Titolo Terreno Type](#)
[Utilizzo Fabbricato Type](#)

schema location: [datiSce_2017_v1.xsd](#)
attribute form default: **unqualified**
element form default: **qualified**
targetNamespace: **urn:www.agenziaentrate.gov.it:specificheTecniche:sco:sce**

Complex types

[Scelta2PerMille_Type](#)
[Scelta2PerMilleAssCult_Type](#)
[Scelta5PerMille_Type](#)
[Scelta8PerMille_Type](#)
[Scelte_Type](#)

element Fornitura

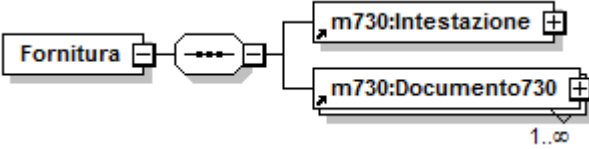
diagram	
namespace	urn:www.agenziaentrate.gov.it:specificheTecniche:sco:730
children	m730:Intestazione m730:Documento730

element Documento730

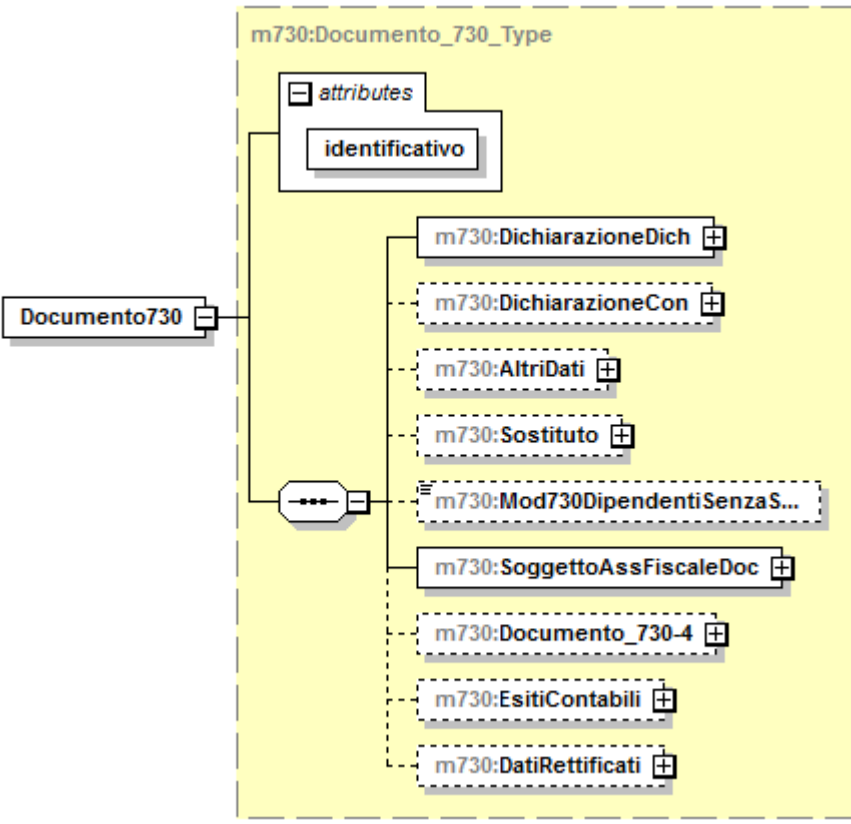
diagram	
namespace	urn:www.agenziaentrate.gov.it:specificheTecniche:sco:730
type	m730:Documento_730_Type
children	m730:DichiarazioneDich m730:DichiarazioneCon m730:AltriDati m730:Sostituto m730:Mod730DipendentiSenzaSostituto m730:SoggettoAssFiscaleDoc m730:Documento_730-4 m730:EsitiContabili m730:DatiRettificati

	m730:DatiRettificati				
attributes	Name identificativo	Type Identificativo Type	Use required	Default	Fixed

complexType [Acconti_Altri_Dati_Type](#)

diagram	
namespace	urn:www.agenziaentrate.gov.it:specificheTecniche:sco:730
children	m730:IncapientiDetrazioneFigli m730:IncapientiDetrazioneLocazione m730:RestituzioneBonusFiscale m730:RestituzioneBonusStraordinario m730:Pignoramento

element [Acconti_Altri_Dati_Type/IncapientiDetrazioneFigli](#)

diagram					
namespace	urn:www.agenziaentrate.gov.it:specificheTecniche:sco:730				
type	DatoNP_Type				
facets	<table border="1"> <tr> <td>Kind</td> <td>Value</td> </tr> <tr> <td>pattern</td> <td>[1-9]{1}[0-9]*</td> </tr> </table>	Kind	Value	pattern	[1-9]{1}[0-9]*
Kind	Value				
pattern	[1-9]{1}[0-9]*				

element [Acconti_Altri_Dati_Type/IncapientiDetrazioneLocazione](#)

diagram					
namespace	urn:www.agenziaentrate.gov.it:specificheTecniche:sco:730				
type	DatoNP_Type				
facets	<table border="1"> <tr> <td>Kind</td> <td>Value</td> </tr> <tr> <td>pattern</td> <td>[1-9]{1}[0-9]*</td> </tr> </table>	Kind	Value	pattern	[1-9]{1}[0-9]*
Kind	Value				
pattern	[1-9]{1}[0-9]*				

element [Acconti_Altri_Dati_Type/RestituzioneBonusFiscale](#)

diagram					
namespace	urn:www.agenziaentrate.gov.it:specificheTecniche:sco:730				
type	DatoNP_Type				
facets	<table border="1"> <tr> <td>Kind</td> <td>Value</td> </tr> <tr> <td>pattern</td> <td>[1-9]{1}[0-9]*</td> </tr> </table>	Kind	Value	pattern	[1-9]{1}[0-9]*
Kind	Value				
pattern	[1-9]{1}[0-9]*				

element **Acconti_Altri_Dati_Type/RestituzioneBonusStraordinario**

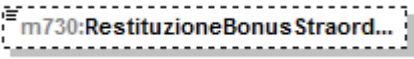
diagram	
namespace	urn:www.agenziaentrate.gov.it:specificheTecniche:sco:730
type	DatoNP_Type
facets	Kind Value pattern [1-9]{1}[0-9]*

element **Acconti_Altri_Dati_Type/Pignoramento**

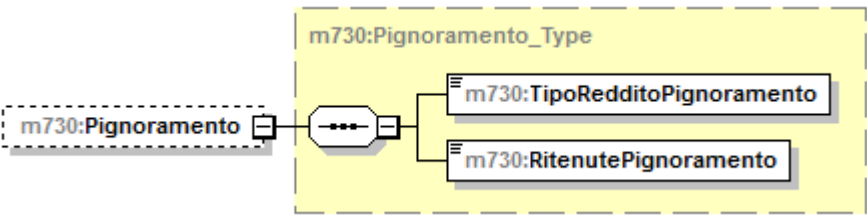
diagram	
namespace	urn:www.agenziaentrate.gov.it:specificheTecniche:sco:730
type	m730:Pignoramento_Type
children	m730:TipoRedditoPignoramento m730:RitenutePignoramento

complexType **Acconti_Irpef_Anno_Imposta_Type**

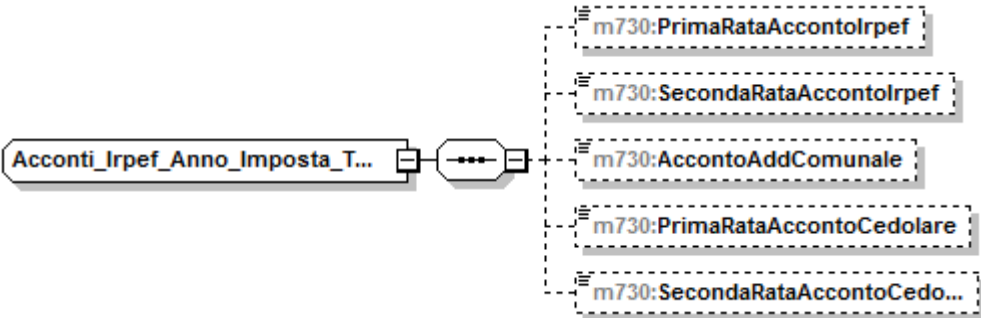
diagram	
namespace	urn:www.agenziaentrate.gov.it:specificheTecniche:sco:730
children	m730:PrimaRataAccontolrpef m730:SecondaRataAccontolrpef m730:AccontoAddComunale m730:PrimaRataAccontoCedolare m730:SecondaRataAccontoCedolare

element **Acconti_Irpef_Anno_Imposta_Type/PrimaRataAccontolrpef**

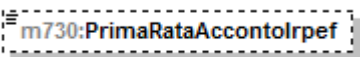
diagram	
namespace	urn:www.agenziaentrate.gov.it:specificheTecniche:sco:730
type	DatoNP_Type

facets	Kind	Value
	pattern	[1-9]{1}[0-9]*

element **Acconti_Irpef_Anno_Imposta_Type/SecondaRataAccontoIrpef**

diagram	
namespace	urn:www.agenziaentrate.gov.it:specificheTecniche:sco:730
type	DatoNP_Type
facets	Kind Value pattern [1-9]{1}[0-9]*

element **Acconti_Irpef_Anno_Imposta_Type/AccontoAddComunale**

diagram	
namespace	urn:www.agenziaentrate.gov.it:specificheTecniche:sco:730
type	DatoNP_Type
facets	Kind Value pattern [1-9]{1}[0-9]*

element **Acconti_Irpef_Anno_Imposta_Type/PrimaRataAccontoCedolare**

diagram	
namespace	urn:www.agenziaentrate.gov.it:specificheTecniche:sco:730
type	DatoNP_Type
facets	Kind Value pattern [1-9]{1}[0-9]*

element **Acconti_Irpef_Anno_Imposta_Type/SecondaRataAccontoCedolare**

diagram	
namespace	urn:www.agenziaentrate.gov.it:specificheTecniche:sco:730
type	DatoNP_Type
facets	Kind Value pattern [1-9]{1}[0-9]*

complexType **Acconti_Ritenute_Type**

diagram	<p>Acconti_Ritenute_Type</p> <p>Quadro F - Acconti Ritenute Eccedenze e Altri Dati</p> <p>m730:PrimoModulo</p> <p>m730:Modulo</p> <p>0..∞</p>
---------	---

namespace	urn:www.agenziaentrate.gov.it:specificheTecniche:sco:730
children	m730:PrimoModulo m730:Modulo

element **Acconti_Ritenute_Type/PrimoModulo**

diagram	<p>The diagram shows a solid box labeled 'm730:PrimoModulo' connected to a dashed box labeled 'm730:Primo_Modulo_Acconti_Ritenute_Type'. Inside this dashed box, several sub-elements are listed, each in a dashed box with a '+' sign: m730:Accontilrpef, m730:AltreRitenute, m730:Eccedenze, m730:EccedenzeOltreAnno, m730:RitenuteAccontiSospesi, m730:MisuraAcconti, m730:EsenzioneAddComunale, m730:Dati730Integrativo, and m730:AccontiAltriDati.</p>
namespace	urn:www.agenziaentrate.gov.it:specificheTecniche:sco:730
type	m730:Primo_Modulo_Acconti_Ritenute_Type
children	m730:Accontilrpef m730:AltreRitenute m730:Eccedenze m730:EccedenzeOltreAnno m730:RitenuteAccontiSospesi m730:MisuraAcconti m730:EsenzioneAddComunale m730:Dati730Integrativo m730:AccontiAltriDati

element **Acconti_Ritenute_Type/Modulo**

diagram	<p>The diagram shows a dashed box labeled 'm730:Modulo' with a multiplicity of '0..∞' connected to a solid box labeled 'm730:Modulo'. This solid box is connected to a dashed box containing two sub-elements: m730:AltreRitenute and m730:Pignoramento.</p>
namespace	urn:www.agenziaentrate.gov.it:specificheTecniche:sco:730
children	m730:AltreRitenute m730:Pignoramento

element **Acconti_Ritenute_Type/Modulo/AltreRitenute**

diagram	
namespace	urn:www.agenziaentrate.gov.it:specificheTecniche:sco:730
type	m730:Altre Ritenute Type
children	m730:Codice m730:AltreRitenuteIrpef m730:AddizionaleRegionale m730:AddizionaleComunale m730:AddRegionaleIrpefAttivitaSport m730:AddComunaleIrpefAttivitaSport m730:IrpefLavoriSocialmenteUtili m730:AddRegionaleIrpefLavoriSoc Utili

element **Acconti_Ritenute_Type/Modulo/Pignoramento**

diagram	
namespace	urn:www.agenziaentrate.gov.it:specificheTecniche:sco:730
type	m730:Pignoramento Type
children	m730:TipoRedditoPignoramento m730:RitenutePignoramento

complexType **Acconti_Compensati_Intern_Type**

diagram	
namespace	urn:www.agenziaentrate.gov.it:specificheTecniche:sco:730

children	m730:PrimaRatalrpef m730:AddizionaleComunale m730:PrimaRataCedolare
----------	---

element **Acoonti_Compensati_Intern_Type/PrimaRatalrpef**

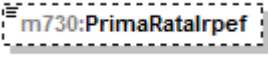
diagram	
namespace	urn:www.agenziaentrate.gov.it:specificheTecniche:sco:730
type	DatoNP_Type
facets	Kind Value pattern [1-9]{1}[0-9]*

element **Acoonti_Compensati_Intern_Type/AddizionaleComunale**

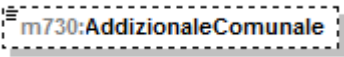
diagram	
namespace	urn:www.agenziaentrate.gov.it:specificheTecniche:sco:730
type	DatoNP_Type
facets	Kind Value pattern [1-9]{1}[0-9]*

element **Acoonti_Compensati_Intern_Type/PrimaRataCedolare**

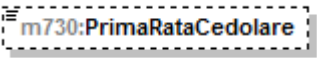
diagram	
namespace	urn:www.agenziaentrate.gov.it:specificheTecniche:sco:730
type	DatoNP_Type
facets	Kind Value pattern [1-9]{1}[0-9]*

complexType **Acquisto_Costruzione_Abit_Type**

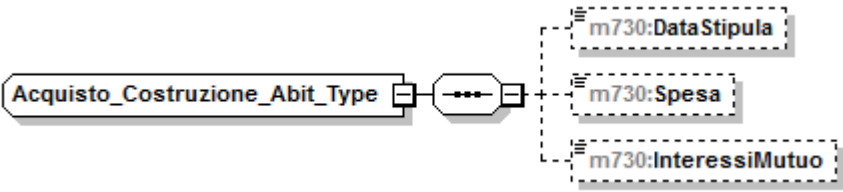
diagram	
namespace	urn:www.agenziaentrate.gov.it:specificheTecniche:sco:730
children	m730:DataStipula m730:Spesa m730:InteressiMutuo

element **Acquisto_Costruzione_Abit_Type/DataStipula**

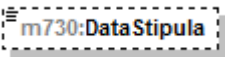
diagram	
namespace	urn:www.agenziaentrate.gov.it:specificheTecniche:sco:730

type	DatoDT_Type				
facets	<table border="1"> <tr> <td>Kind</td> <td>Value</td> </tr> <tr> <td>pattern</td> <td>((([0-9]{12} [0-9]{3} [0-9]{1}) (0[13579] 10 12)\d{4}) ((([0-9]{12} [0-9]{3} [0-9]{1}) (0[469] 11)\d{4}) ((([0-9]{12} [0-9]{3} [0-9]{1}) (0[2468] 10)\d{4}) ((29)(02)([02468] 048)00) ((29)(02)([13579] 26)00) ((29)(02)([0-9]{10} [0-9]{48}) ((29)(02)([0-9]{10} [0-9]{48})) ((29)(02)([0-9]{10} [0-9]{26})))</td> </tr> </table>	Kind	Value	pattern	((([0-9]{12} [0-9]{3} [0-9]{1}) (0[13579] 10 12)\d{4}) ((([0-9]{12} [0-9]{3} [0-9]{1}) (0[469] 11)\d{4}) ((([0-9]{12} [0-9]{3} [0-9]{1}) (0[2468] 10)\d{4}) ((29)(02)([02468] 048)00) ((29)(02)([13579] 26)00) ((29)(02)([0-9]{10} [0-9]{48}) ((29)(02)([0-9]{10} [0-9]{48})) ((29)(02)([0-9]{10} [0-9]{26})))
Kind	Value				
pattern	((([0-9]{12} [0-9]{3} [0-9]{1}) (0[13579] 10 12)\d{4}) ((([0-9]{12} [0-9]{3} [0-9]{1}) (0[469] 11)\d{4}) ((([0-9]{12} [0-9]{3} [0-9]{1}) (0[2468] 10)\d{4}) ((29)(02)([02468] 048)00) ((29)(02)([13579] 26)00) ((29)(02)([0-9]{10} [0-9]{48}) ((29)(02)([0-9]{10} [0-9]{48})) ((29)(02)([0-9]{10} [0-9]{26})))				

element **Acquisto_Costruzione_Abit_Type/Spesa**

diagram					
namespace	urn:www.agenziaentrate.gov.it:specificheTecniche:sco:730				
type	DatoNP_Type				
facets	<table border="1"> <tr> <td>Kind</td> <td>Value</td> </tr> <tr> <td>pattern</td> <td>[1-9]{1}[0-9]*</td> </tr> </table>	Kind	Value	pattern	[1-9]{1}[0-9]*
Kind	Value				
pattern	[1-9]{1}[0-9]*				

element **Acquisto_Costruzione_Abit_Type/InteressiMutuo**

diagram					
namespace	urn:www.agenziaentrate.gov.it:specificheTecniche:sco:730				
type	DatoNP_Type				
facets	<table border="1"> <tr> <td>Kind</td> <td>Value</td> </tr> <tr> <td>pattern</td> <td>[1-9]{1}[0-9]*</td> </tr> </table>	Kind	Value	pattern	[1-9]{1}[0-9]*
Kind	Value				
pattern	[1-9]{1}[0-9]*				

complexType **Addizionali_Type**

diagram	
namespace	urn:www.agenziaentrate.gov.it:specificheTecniche:sco:730
children	m730:Imponibile m730:AddRegDovuta m730:AddRegCertif m730:EccedenzaAddReg m730:AddComDovuta m730:AddComCertif m730:EccedenzaAddCom m730:AccontoAddCom m730:AccontoAddComCertif

element Addizionali_Type/Imponibile

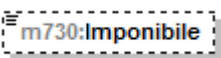
diagram	
namespace	urn:www.agenziaentrate.gov.it:specificheTecniche:sco:730
type	DatoNP_Type
facets	Kind Value pattern [1-9]{1}[0-9]*

element Addizionali_Type/AddRegDovuta

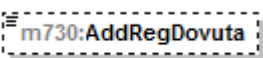
diagram	
namespace	urn:www.agenziaentrate.gov.it:specificheTecniche:sco:730
type	DatoNP_Type
facets	Kind Value pattern [1-9]{1}[0-9]*

element Addizionali_Type/AddRegCertif

diagram	
namespace	urn:www.agenziaentrate.gov.it:specificheTecniche:sco:730
type	DatoNP_Type
facets	Kind Value pattern [1-9]{1}[0-9]*

element Addizionali_Type/EccedenzaAddReg

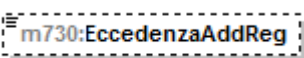
diagram	
namespace	urn:www.agenziaentrate.gov.it:specificheTecniche:sco:730
type	DatoNU_Type
facets	Kind Value pattern (\-[1-9] [1-9])[0-9]*

element Addizionali_Type/AddComDovuta

diagram	
namespace	urn:www.agenziaentrate.gov.it:specificheTecniche:sco:730
type	DatoNP_Type
facets	Kind Value pattern [1-9]{1}[0-9]*

element **Addizionali_Type/AddComCertif**

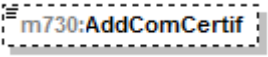
diagram	
namespace	urn:www.agenziaentrate.gov.it:specificheTecniche:sco:730
type	DatoNP_Type
facets	Kind Value pattern [1-9]{1}[0-9]*

element **Addizionali_Type/EccedenzaAddCom**

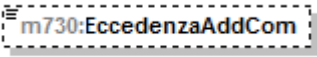
diagram	
namespace	urn:www.agenziaentrate.gov.it:specificheTecniche:sco:730
type	DatoNU_Type
facets	Kind Value pattern (\-[1-9] [1-9])[0-9]*

element **Addizionali_Type/AccontoAddCom**

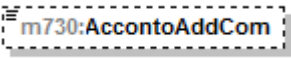
diagram	
namespace	urn:www.agenziaentrate.gov.it:specificheTecniche:sco:730
type	DatoNP_Type
facets	Kind Value pattern [1-9]{1}[0-9]*

element **Addizionali_Type/AccontoAddComCertif**

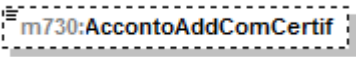
diagram	
namespace	urn:www.agenziaentrate.gov.it:specificheTecniche:sco:730
type	DatoNP_Type
facets	Kind Value pattern [1-9]{1}[0-9]*

complexType **Altre_Detrazioni_Type**

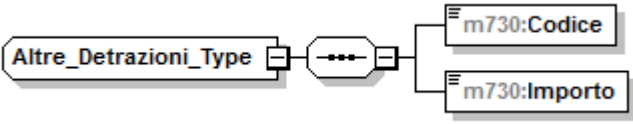
diagram	
namespace	urn:www.agenziaentrate.gov.it:specificheTecniche:sco:730
children	m730:Codice m730:Importo

element **Altre_Detrazioni_Type/Codice**

diagram									
namespace	urn:www.agenziaentrate.gov.it:specificheTecniche:sco:730								
type	m730:Codice_Altre_Detrazioni_Type								
facets	<table border="1"> <thead> <tr> <th>Kind</th> <th>Value</th> </tr> </thead> <tbody> <tr> <td>pattern</td> <td>[1-9]{1}[0-9]*</td> </tr> <tr> <td>enumeration</td> <td>1</td> </tr> <tr> <td>enumeration</td> <td>2</td> </tr> </tbody> </table>	Kind	Value	pattern	[1-9]{1}[0-9]*	enumeration	1	enumeration	2
Kind	Value								
pattern	[1-9]{1}[0-9]*								
enumeration	1								
enumeration	2								

element **Altre_Detrazioni_Type/Importo**

diagram					
namespace	urn:www.agenziaentrate.gov.it:specificheTecniche:sco:730				
type	DatoNP_Type				
facets	<table border="1"> <thead> <tr> <th>Kind</th> <th>Value</th> </tr> </thead> <tbody> <tr> <td>pattern</td> <td>[1-9]{1}[0-9]*</td> </tr> </tbody> </table>	Kind	Value	pattern	[1-9]{1}[0-9]*
Kind	Value				
pattern	[1-9]{1}[0-9]*				

complexType **Altre_Ritenute_Type**

diagram	
namespace	urn:www.agenziaentrate.gov.it:specificheTecniche:sco:730
children	m730:Codice m730:AltreRitenuteIrpef m730:AddizionaleRegionale m730:AddizionaleComunale m730:AddRegionaleIrpefAttivitaSport m730:AddComunaleIrpefAttivitaSport m730:IrpefLavoriSocialmenteUtili m730:AddRegionaleIrpefLavoriSoc_Utili

element **Altre_Ritenute_Type/Codice**

diagram	
---------	--

namespace	urn:www.agenziaentrate.gov.it:specificheTecniche:sco:730								
type	restriction of DatoN1_Type								
facets	<table border="0"> <tr> <td>Kind</td> <td>Value</td> </tr> <tr> <td>pattern</td> <td>[1-9]</td> </tr> <tr> <td>enumeration</td> <td>1</td> </tr> <tr> <td>enumeration</td> <td>2</td> </tr> </table>	Kind	Value	pattern	[1-9]	enumeration	1	enumeration	2
Kind	Value								
pattern	[1-9]								
enumeration	1								
enumeration	2								

element **Altre_Ritenute_Type/AltreRitenuteIrpef**

diagram					
namespace	urn:www.agenziaentrate.gov.it:specificheTecniche:sco:730				
type	DatoNP_Type				
facets	<table border="0"> <tr> <td>Kind</td> <td>Value</td> </tr> <tr> <td>pattern</td> <td>[1-9]{1}[0-9]*</td> </tr> </table>	Kind	Value	pattern	[1-9]{1}[0-9]*
Kind	Value				
pattern	[1-9]{1}[0-9]*				

element **Altre_Ritenute_Type/AddizionaleRegionale**

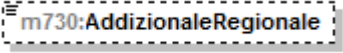
diagram					
namespace	urn:www.agenziaentrate.gov.it:specificheTecniche:sco:730				
type	DatoNP_Type				
facets	<table border="0"> <tr> <td>Kind</td> <td>Value</td> </tr> <tr> <td>pattern</td> <td>[1-9]{1}[0-9]*</td> </tr> </table>	Kind	Value	pattern	[1-9]{1}[0-9]*
Kind	Value				
pattern	[1-9]{1}[0-9]*				

element **Altre_Ritenute_Type/AddizionaleComunale**

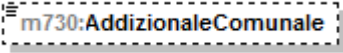
diagram					
namespace	urn:www.agenziaentrate.gov.it:specificheTecniche:sco:730				
type	DatoNP_Type				
facets	<table border="0"> <tr> <td>Kind</td> <td>Value</td> </tr> <tr> <td>pattern</td> <td>[1-9]{1}[0-9]*</td> </tr> </table>	Kind	Value	pattern	[1-9]{1}[0-9]*
Kind	Value				
pattern	[1-9]{1}[0-9]*				

element **Altre_Ritenute_Type/AddRegionaleIrpefAttivitaSport**

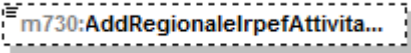
diagram					
namespace	urn:www.agenziaentrate.gov.it:specificheTecniche:sco:730				
type	DatoNP_Type				
facets	<table border="0"> <tr> <td>Kind</td> <td>Value</td> </tr> <tr> <td>pattern</td> <td>[1-9]{1}[0-9]*</td> </tr> </table>	Kind	Value	pattern	[1-9]{1}[0-9]*
Kind	Value				
pattern	[1-9]{1}[0-9]*				

element **Altre_Ritenute_Type/AddComunalelrpefAttivitaSport**

diagram					
namespace	urn:www.agenziaentrate.gov.it:specificheTecniche:sco:730				
type	DatoNP_Type				
facets	<table border="1"> <tr> <td>Kind</td> <td>Value</td> </tr> <tr> <td>pattern</td> <td>[1-9]{1}[0-9]*</td> </tr> </table>	Kind	Value	pattern	[1-9]{1}[0-9]*
Kind	Value				
pattern	[1-9]{1}[0-9]*				

element **Altre_Ritenute_Type/IrpefLavoriSocialmenteUtili**

diagram					
namespace	urn:www.agenziaentrate.gov.it:specificheTecniche:sco:730				
type	DatoNP_Type				
facets	<table border="1"> <tr> <td>Kind</td> <td>Value</td> </tr> <tr> <td>pattern</td> <td>[1-9]{1}[0-9]*</td> </tr> </table>	Kind	Value	pattern	[1-9]{1}[0-9]*
Kind	Value				
pattern	[1-9]{1}[0-9]*				

element **Altre_Ritenute_Type/AddRegionalelrpefLavoriSoc_Utili**

diagram					
namespace	urn:www.agenziaentrate.gov.it:specificheTecniche:sco:730				
type	DatoNP_Type				
facets	<table border="1"> <tr> <td>Kind</td> <td>Value</td> </tr> <tr> <td>pattern</td> <td>[1-9]{1}[0-9]*</td> </tr> </table>	Kind	Value	pattern	[1-9]{1}[0-9]*
Kind	Value				
pattern	[1-9]{1}[0-9]*				

complexType **Altre_Spese_Type**

diagram	
namespace	urn:www.agenziaentrate.gov.it:specificheTecniche:sco:730
children	m730:Codice m730:Importo

element **Altre_Spese_Type/Codice**

diagram											
namespace	urn:www.agenziaentrate.gov.it:specificheTecniche:sco:730										
type	restriction of m730:Codice Altre_Spese_Type										
facets	<table border="1"> <tr> <td>Kind</td> <td>Value</td> </tr> <tr> <td>pattern</td> <td>[1-9]{1}[0-9]*</td> </tr> <tr> <td>enumeration</td> <td>8</td> </tr> <tr> <td>enumeration</td> <td>9</td> </tr> <tr> <td>enumeration</td> <td>10</td> </tr> </table>	Kind	Value	pattern	[1-9]{1}[0-9]*	enumeration	8	enumeration	9	enumeration	10
Kind	Value										
pattern	[1-9]{1}[0-9]*										
enumeration	8										
enumeration	9										
enumeration	10										

	enumeration	11
	enumeration	12
	enumeration	13
	enumeration	14
	enumeration	15
	enumeration	16
	enumeration	17
	enumeration	18
	enumeration	20
	enumeration	21
	enumeration	22
	enumeration	23
	enumeration	24
	enumeration	25
	enumeration	26
	enumeration	27
	enumeration	28
	enumeration	29
	enumeration	30
	enumeration	31
	enumeration	32
	enumeration	33
	enumeration	35
	enumeration	36
	enumeration	38
	enumeration	39
	enumeration	41
	enumeration	42
	enumeration	99

element Altre_Spese_Type/Importo

diagram					
namespace	urn:www.agenziaentrate.gov.it:specificheTecniche:sco:730				
type	DatoNP_Type				
facets	<table border="1"> <thead> <tr> <th>Kind</th> <th>Value</th> </tr> </thead> <tbody> <tr> <td>pattern</td> <td>[1-9]{1}[0-9]*</td> </tr> </tbody> </table>	Kind	Value	pattern	[1-9]{1}[0-9]*
Kind	Value				
pattern	[1-9]{1}[0-9]*				

complexType Altri_Dati_Type

<p>diagram</p>	
<p>namespace</p>	<p>urn:www.agenziaentrate.gov.it:specificheTecniche:sco:730</p>
<p>children</p>	<p>m730:ResiduoCreditoErogazioneCultura m730:ResiduoCreditoPrimaCasa m730:ResiduoCreditoOccupazione m730:ResiduoCreditoSisma m730:ResiduoCreditoFondiPensione m730:ResiduoCreditoMediazioni m730:TotSpeseSanitarieRateizzate m730:RedditoAgevolazioniFiscali m730:RedditoComplessivoAcconto m730:RigoDifferenzaAcconto m730:AccontiCompensatiIntern m730:RedditiFondariNonImponibili m730:RedditoAbitazionePrincipalePertinenze m730:ResiduoDeduzioneSommeRestituite m730:ResiduoErogazioniScuola m730:ResiduoCreditoNegoziazione m730:ResiduoCreditoVideosorveglianza m730:CreditoErogazioneCultura</p>

element Altri_Dati_Type/ResiduoCreditoErogazioneCultura

<p>diagram</p>	
<p>namespace</p>	<p>urn:www.agenziaentrate.gov.it:specificheTecniche:sco:730</p>

type	DatoNP_Type
facets	Kind Value pattern [1-9]{1}[0-9]*

element Altri_Dati_Type/ResiduoCreditoPrimaCasa

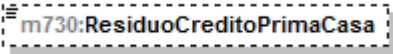
diagram	
namespace	urn:www.agenziaentrate.gov.it:specificheTecniche:sco:730
type	DatoNP_Type
facets	Kind Value pattern [1-9]{1}[0-9]*

element Altri_Dati_Type/ResiduoCreditoOccupazione

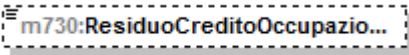
diagram	
namespace	urn:www.agenziaentrate.gov.it:specificheTecniche:sco:730
type	DatoNP_Type
facets	Kind Value pattern [1-9]{1}[0-9]*

element Altri_Dati_Type/ResiduoCreditoSisma

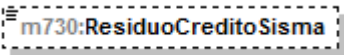
diagram	
namespace	urn:www.agenziaentrate.gov.it:specificheTecniche:sco:730
type	DatoNP_Type
facets	Kind Value pattern [1-9]{1}[0-9]*

element Altri_Dati_Type/ResiduoCreditoFondiPensione

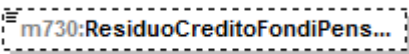
diagram	
namespace	urn:www.agenziaentrate.gov.it:specificheTecniche:sco:730
type	DatoNP_Type
facets	Kind Value pattern [1-9]{1}[0-9]*

element Altri_Dati_Type/ResiduoCreditoMediazioni

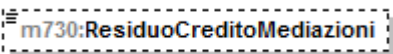
diagram	
namespace	urn:www.agenziaentrate.gov.it:specificheTecniche:sco:730

type	DatoNP_Type
facets	Kind Value pattern [1-9]{1}[0-9]*

element Altri_Dati_Type/TotSpeseSanitarieRateizzate

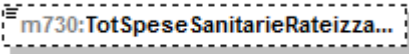
diagram	
namespace	urn:www.agenziaentrate.gov.it:specificheTecniche:sco:730
type	DatoNP_Type
facets	Kind Value pattern [1-9]{1}[0-9]*

element Altri_Dati_Type/RedditoAgevolazioniFiscali

diagram	
namespace	urn:www.agenziaentrate.gov.it:specificheTecniche:sco:730
type	DatoNP_Type
facets	Kind Value pattern [1-9]{1}[0-9]*

element Altri_Dati_Type/RedditoComplessivoAcconto

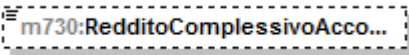
diagram	
namespace	urn:www.agenziaentrate.gov.it:specificheTecniche:sco:730
type	DatoNP_Type
facets	Kind Value pattern [1-9]{1}[0-9]*

element Altri_Dati_Type/RigoDifferenzaAcconto

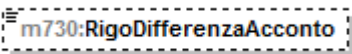
diagram	
namespace	urn:www.agenziaentrate.gov.it:specificheTecniche:sco:730
type	DatoNU_Type
facets	Kind Value pattern (\- 1-9 [1-9])[0-9]*

element **Altri_Dati_Type/AcontiCompensatiIntern**

diagram	<pre> classDiagram class m730AcontiCompensatiIntern class m730Acoonti_Compensati_Intern_Type class m730PrimaRatalrpef class m730AddizionaleComunale class m730PrimaRataCedolare m730AcontiCompensatiIntern < -- m730Acoonti_Compensati_Intern_Type m730Acoonti_Compensati_Intern_Type < -- m730PrimaRatalrpef m730Acoonti_Compensati_Intern_Type < -- m730AddizionaleComunale m730Acoonti_Compensati_Intern_Type < -- m730PrimaRataCedolare </pre>
namespace	urn:www.agenziaentrate.gov.it:specificheTecniche:sco:730
type	m730:Acoonti_Compensati_Intern_Type
children	m730:PrimaRatalrpef m730:AddizionaleComunale m730:PrimaRataCedolare

element **Altri_Dati_Type/RedditiFondariNonImponibili**

diagram	<pre> classDiagram class m730RedditiFondariNonImponibili </pre>				
namespace	urn:www.agenziaentrate.gov.it:specificheTecniche:sco:730				
type	DatoNP_Type				
facets	<table border="1"> <thead> <tr> <th>Kind</th> <th>Value</th> </tr> </thead> <tbody> <tr> <td>pattern</td> <td>[1-9]{1}[0-9]*</td> </tr> </tbody> </table>	Kind	Value	pattern	[1-9]{1}[0-9]*
Kind	Value				
pattern	[1-9]{1}[0-9]*				

element **Altri_Dati_Type/RedditoAbitazionePrincipalePertinenze**

diagram	<pre> classDiagram class m730RedditoAbitazionePrincipalePertinenze </pre>				
namespace	urn:www.agenziaentrate.gov.it:specificheTecniche:sco:730				
type	DatoNP_Type				
facets	<table border="1"> <thead> <tr> <th>Kind</th> <th>Value</th> </tr> </thead> <tbody> <tr> <td>pattern</td> <td>[1-9]{1}[0-9]*</td> </tr> </tbody> </table>	Kind	Value	pattern	[1-9]{1}[0-9]*
Kind	Value				
pattern	[1-9]{1}[0-9]*				

element **Altri_Dati_Type/ResiduoDeduzioneSommeRestituite**

diagram	<pre> classDiagram class m730ResiduoDeduzioneSommeRestituite </pre>				
namespace	urn:www.agenziaentrate.gov.it:specificheTecniche:sco:730				
type	DatoNP_Type				
facets	<table border="1"> <thead> <tr> <th>Kind</th> <th>Value</th> </tr> </thead> <tbody> <tr> <td>pattern</td> <td>[1-9]{1}[0-9]*</td> </tr> </tbody> </table>	Kind	Value	pattern	[1-9]{1}[0-9]*
Kind	Value				
pattern	[1-9]{1}[0-9]*				

element **Altri_Dati_Type/ResiduoErogazioniScuola**

diagram	<pre> classDiagram class m730ResiduoErogazioniScuola </pre>
---------	---

namespace	urn:www.agenziaentrate.gov.it:specificheTecniche:sco:730
type	DatoNP_Type
facets	Kind Value pattern [1-9]{1}[0-9]*

element Altri_Dati_Type/ResiduoCreditoNegoziazione

diagram	
namespace	urn:www.agenziaentrate.gov.it:specificheTecniche:sco:730
type	DatoNP_Type
facets	Kind Value pattern [1-9]{1}[0-9]*

element Altri_Dati_Type/ResiduoCreditoVideosorveglianza

diagram	
namespace	urn:www.agenziaentrate.gov.it:specificheTecniche:sco:730
type	DatoNP_Type
facets	Kind Value pattern [1-9]{1}[0-9]*

element Altri_Dati_Type/CreditoErogazioneCultura

diagram	
namespace	urn:www.agenziaentrate.gov.it:specificheTecniche:sco:730
type	m730:Cred_Erogazione_Cultura_Type
children	m730:RataAnnoPrec m730:RataAnno

complexType Altri_Oneri_Type

diagram	
namespace	urn:www.agenziaentrate.gov.it:specificheTecniche:sco:730
children	m730:Codice m730:Importo

element **Altri_Oneri_Type/Codice**

diagram																			
namespace	urn:www.agenziaentrate.gov.it:specificheTecniche:sco:730																		
type	m730:Codice_Altri_Oneri_Type																		
facets	<table border="1"> <thead> <tr> <th>Kind</th> <th>Value</th> </tr> </thead> <tbody> <tr> <td>pattern</td> <td>[1-9]{1}[0-9]*</td> </tr> <tr> <td>enumeration</td> <td>6</td> </tr> <tr> <td>enumeration</td> <td>7</td> </tr> <tr> <td>enumeration</td> <td>8</td> </tr> <tr> <td>enumeration</td> <td>9</td> </tr> <tr> <td>enumeration</td> <td>12</td> </tr> <tr> <td>enumeration</td> <td>13</td> </tr> <tr> <td>enumeration</td> <td>21</td> </tr> </tbody> </table>	Kind	Value	pattern	[1-9]{1}[0-9]*	enumeration	6	enumeration	7	enumeration	8	enumeration	9	enumeration	12	enumeration	13	enumeration	21
Kind	Value																		
pattern	[1-9]{1}[0-9]*																		
enumeration	6																		
enumeration	7																		
enumeration	8																		
enumeration	9																		
enumeration	12																		
enumeration	13																		
enumeration	21																		

element **Altri_Oneri_Type/Importo**

diagram					
namespace	urn:www.agenziaentrate.gov.it:specificheTecniche:sco:730				
type	DatoNP_Type				
facets	<table border="1"> <thead> <tr> <th>Kind</th> <th>Value</th> </tr> </thead> <tbody> <tr> <td>pattern</td> <td>[1-9]{1}[0-9]*</td> </tr> </tbody> </table>	Kind	Value	pattern	[1-9]{1}[0-9]*
Kind	Value				
pattern	[1-9]{1}[0-9]*				

complexType **Altri_Reddito_Ass_Lav_Type**

diagram	
namespace	urn:www.agenziaentrate.gov.it:specificheTecniche:sco:730
children	m730:AssegnoDelConiuge m730:ImportoRedditoAssimilato

element **Altri_Reddito_Ass_Lav_Type/AssegnoDelConiuge**

diagram					
namespace	urn:www.agenziaentrate.gov.it:specificheTecniche:sco:730				
type	DatoCB_Type				
facets	<table border="1"> <thead> <tr> <th>Kind</th> <th>Value</th> </tr> </thead> <tbody> <tr> <td>pattern</td> <td>[01]</td> </tr> </tbody> </table>	Kind	Value	pattern	[01]
Kind	Value				
pattern	[01]				

element **Altri_Reddito_Ass_Lav_Type/ImportoRedditoAssimilato**

diagram	
---------	--

namespace	urn:www.agenziaentrate.gov.it:specificheTecniche:sco:730				
type	DatoNP_Type				
facets	<table border="1"> <tr> <td>Kind</td> <td>Value</td> </tr> <tr> <td>pattern</td> <td>[1-9]{1}[0-9]*</td> </tr> </table>	Kind	Value	pattern	[1-9]{1}[0-9]*
Kind	Value				
pattern	[1-9]{1}[0-9]*				

complexType Altri_Reddito_Diversi_Detr_Type

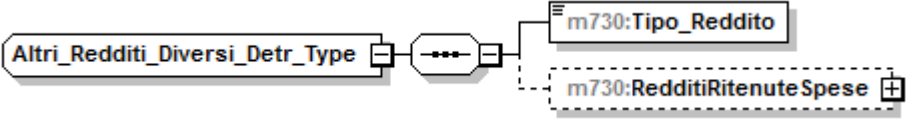
diagram	
namespace	urn:www.agenziaentrate.gov.it:specificheTecniche:sco:730
children	m730:Tipo_Reddito m730:RedditoRitenuteSpese

element Altri_Reddito_Diversi_Detr_Type/Tipo_Reddito

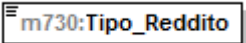
diagram													
namespace	urn:www.agenziaentrate.gov.it:specificheTecniche:sco:730												
type	m730:Tipo_Reddito Da1a4_Type												
facets	<table border="1"> <tr> <td>Kind</td> <td>Value</td> </tr> <tr> <td>pattern</td> <td>[1-9]</td> </tr> <tr> <td>enumeration</td> <td>1</td> </tr> <tr> <td>enumeration</td> <td>2</td> </tr> <tr> <td>enumeration</td> <td>3</td> </tr> <tr> <td>enumeration</td> <td>4</td> </tr> </table>	Kind	Value	pattern	[1-9]	enumeration	1	enumeration	2	enumeration	3	enumeration	4
Kind	Value												
pattern	[1-9]												
enumeration	1												
enumeration	2												
enumeration	3												
enumeration	4												

element Altri_Reddito_Diversi_Detr_Type/RedditoRitenuteSpese

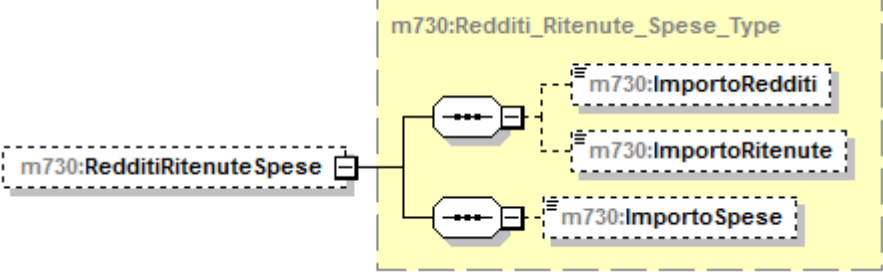
diagram	
namespace	urn:www.agenziaentrate.gov.it:specificheTecniche:sco:730
type	m730:Reddito_Ritenute_Spese_Type
children	m730:ImportoReddito m730:ImportoRitenute m730:ImportoSpese

complexType **Altri_Reddi_Diversi_Type**

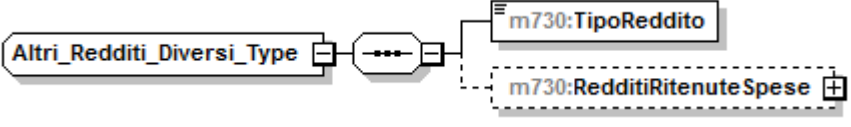
diagram	
namespace	urn:www.agenziaentrate.gov.it:specificheTecniche:sco:730
children	m730:TipoReddito m730:RedditiRitenuteSpese

element **Altri_Reddi_Diversi_Type/TipoReddito**

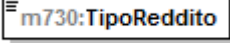
diagram																							
namespace	urn:www.agenziaentrate.gov.it:specificheTecniche:sco:730																						
type	m730:Tipo_Reddito_Da1a9_Type																						
facets	<table border="1"> <thead> <tr> <th>Kind</th> <th>Value</th> </tr> </thead> <tbody> <tr> <td>pattern</td> <td>[1-9]{1}[0-9]*</td> </tr> <tr> <td>enumeration</td> <td>1</td> </tr> <tr> <td>enumeration</td> <td>2</td> </tr> <tr> <td>enumeration</td> <td>3</td> </tr> <tr> <td>enumeration</td> <td>4</td> </tr> <tr> <td>enumeration</td> <td>5</td> </tr> <tr> <td>enumeration</td> <td>6</td> </tr> <tr> <td>enumeration</td> <td>7</td> </tr> <tr> <td>enumeration</td> <td>8</td> </tr> <tr> <td>enumeration</td> <td>9</td> </tr> </tbody> </table>	Kind	Value	pattern	[1-9]{1}[0-9]*	enumeration	1	enumeration	2	enumeration	3	enumeration	4	enumeration	5	enumeration	6	enumeration	7	enumeration	8	enumeration	9
Kind	Value																						
pattern	[1-9]{1}[0-9]*																						
enumeration	1																						
enumeration	2																						
enumeration	3																						
enumeration	4																						
enumeration	5																						
enumeration	6																						
enumeration	7																						
enumeration	8																						
enumeration	9																						

element **Altri_Reddi_Diversi_Type/RedditiRitenuteSpese**

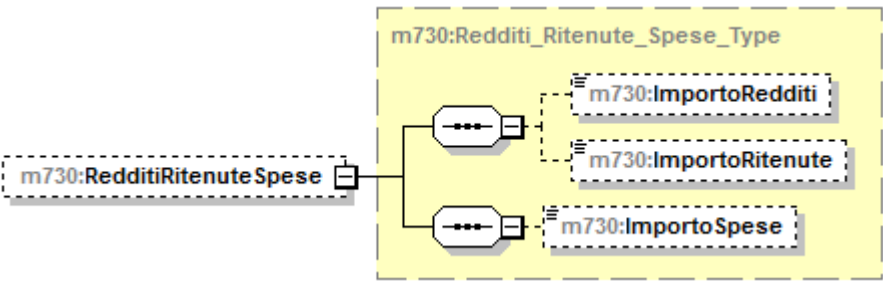
diagram	
namespace	urn:www.agenziaentrate.gov.it:specificheTecniche:sco:730
type	m730:Redditi_Ritenute_Spese_Type
children	m730:ImportoRedditi m730:ImportoRitenute m730:ImportoSpese

complexType **Altri_Reddi_Lavoro_Autonomo_Type**

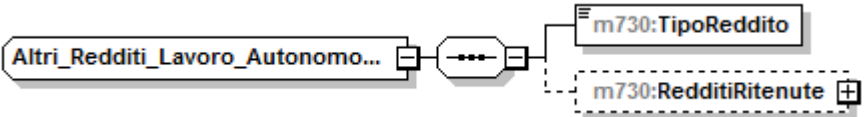
diagram	
namespace	urn:www.agenziaentrate.gov.it:specificheTecniche:sco:730

children	m730:TipoReddito m730:RedditiRitenute
----------	---

element **Altri_Redditi_Lavoro_Autonomo_Type/TipoReddito**

diagram											
namespace	urn:www.agenziaentrate.gov.it:specificheTecniche:sco:730										
type	m730:Tipo Reddito Da1a3 Type										
facets	<table border="1"> <thead> <tr> <th>Kind</th> <th>Value</th> </tr> </thead> <tbody> <tr> <td>pattern</td> <td>[1-9]</td> </tr> <tr> <td>enumeration</td> <td>1</td> </tr> <tr> <td>enumeration</td> <td>2</td> </tr> <tr> <td>enumeration</td> <td>3</td> </tr> </tbody> </table>	Kind	Value	pattern	[1-9]	enumeration	1	enumeration	2	enumeration	3
Kind	Value										
pattern	[1-9]										
enumeration	1										
enumeration	2										
enumeration	3										

element **Altri_Redditi_Lavoro_Autonomo_Type/RedditiRitenute**

diagram	
namespace	urn:www.agenziaentrate.gov.it:specificheTecniche:sco:730
type	m730:Redditi Ritenute Type
children	m730:ImportoRedditi m730:ImportoRitenute

complexType **Altri_Redditi_Type**

diagram	
namespace	urn:www.agenziaentrate.gov.it:specificheTecniche:sco:730
children	m730:Modulo

element **Altri_Redditi_Type/Modulo**

diagram	
namespace	urn:www.agenziaentrate.gov.it:specificheTecniche:sco:730
type	m730:Modulo Altri Redditi Type

children	m730:RedditiDiCapitale m730:RedditiTassazioneSeparata
----------	---

complexType Altri_Redditi_Utili_Type

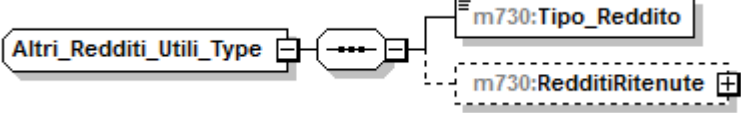
diagram	
namespace	urn:www.agenziaentrate.gov.it:specificheTecniche:sco:730
children	m730:Tipo_Reddito m730:RedditiRitenute

element Altri_Redditi_Utili_Type/Tipo_Reddito

diagram																					
namespace	urn:www.agenziaentrate.gov.it:specificheTecniche:sco:730																				
type	m730:Tipo_Reddito_Da1a8_Type																				
facets	<table border="1"> <thead> <tr> <th>Kind</th> <th>Value</th> </tr> </thead> <tbody> <tr> <td>pattern</td> <td>[1-9]{1}[0-9]*</td> </tr> <tr> <td>enumeration</td> <td>1</td> </tr> <tr> <td>enumeration</td> <td>2</td> </tr> <tr> <td>enumeration</td> <td>3</td> </tr> <tr> <td>enumeration</td> <td>4</td> </tr> <tr> <td>enumeration</td> <td>5</td> </tr> <tr> <td>enumeration</td> <td>6</td> </tr> <tr> <td>enumeration</td> <td>7</td> </tr> <tr> <td>enumeration</td> <td>8</td> </tr> </tbody> </table>	Kind	Value	pattern	[1-9]{1}[0-9]*	enumeration	1	enumeration	2	enumeration	3	enumeration	4	enumeration	5	enumeration	6	enumeration	7	enumeration	8
Kind	Value																				
pattern	[1-9]{1}[0-9]*																				
enumeration	1																				
enumeration	2																				
enumeration	3																				
enumeration	4																				
enumeration	5																				
enumeration	6																				
enumeration	7																				
enumeration	8																				

element Altri_Redditi_Utili_Type/RedditiRitenute

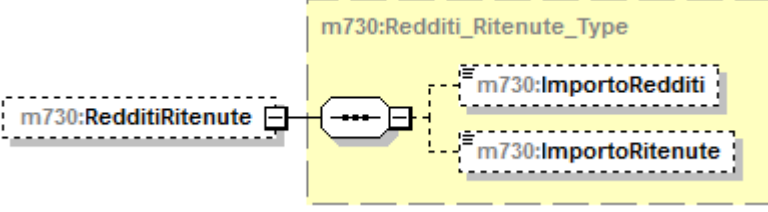
diagram	
namespace	urn:www.agenziaentrate.gov.it:specificheTecniche:sco:730
type	m730:Redditi_Ritenute_Type
children	m730:ImportoRedditi m730:ImportoRitenute

complexType **Annotazione_Type**

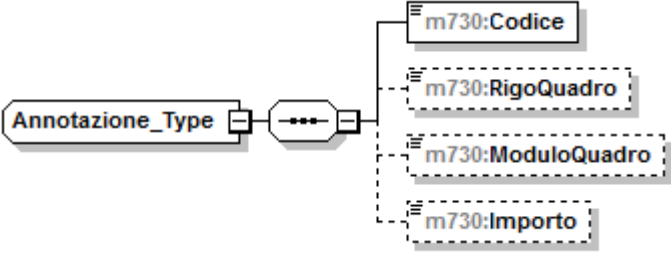
diagram	
namespace	urn:www.agenziaentrate.gov.it:specificheTecniche:sco:730
children	m730:Codice m730:RigoQuadro m730:ModuloQuadro m730:Importo

element **Annotazione_Type/Codice**

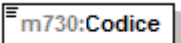
diagram					
namespace	urn:www.agenziaentrate.gov.it:specificheTecniche:sco:730				
type	DatoAN_Type				
facets	<table><tr><td>Kind</td><td>Value</td></tr><tr><td>pattern</td><td>([0-9A-Z\-_]\&quot;){1}([0-9A-Z&amp;#160;] '\- \., / °\^\\(\) À É È Ì Ò Ù Ú Û &quot; \N \+)*</td></tr></table>	Kind	Value	pattern	([0-9A-Z\-_]\"){1}([0-9A-Z&#160;] '\- \., / °\^\\(\) À É È Ì Ò Ù Ú Û " \N \+)*
Kind	Value				
pattern	([0-9A-Z\-_]\"){1}([0-9A-Z&#160;] '\- \., / °\^\\(\) À É È Ì Ò Ù Ú Û " \N \+)*				

element **Annotazione_Type/RigoQuadro**

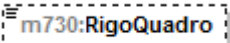
diagram					
namespace	urn:www.agenziaentrate.gov.it:specificheTecniche:sco:730				
type	DatoNP_Type				
facets	<table><tr><td>Kind</td><td>Value</td></tr><tr><td>pattern</td><td>[1-9]{1}[0-9]*</td></tr></table>	Kind	Value	pattern	[1-9]{1}[0-9]*
Kind	Value				
pattern	[1-9]{1}[0-9]*				

element **Annotazione_Type/ModuloQuadro**

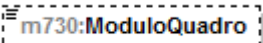
diagram					
namespace	urn:www.agenziaentrate.gov.it:specificheTecniche:sco:730				
type	DatoNP_Type				
facets	<table><tr><td>Kind</td><td>Value</td></tr><tr><td>pattern</td><td>[1-9]{1}[0-9]*</td></tr></table>	Kind	Value	pattern	[1-9]{1}[0-9]*
Kind	Value				
pattern	[1-9]{1}[0-9]*				

element **Annotazione_Type/Importo**

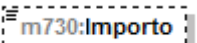
diagram	
namespace	urn:www.agenziaentrate.gov.it:specificheTecniche:sco:730
type	DatoNP_Type

facets	Kind pattern	Value [1-9]{1}[0-9]*
--------	-----------------	-------------------------

complexType **Assegno_Coniuge_Type**

diagram	
namespace	urn:www.agenziaentrate.gov.it:specificheTecniche:sco:730
children	m730:CodiceFiscale m730:Importo

element **Assegno_Coniuge_Type/CodiceFiscale**

diagram		
namespace	urn:www.agenziaentrate.gov.it:specificheTecniche:sco:730	
type	DatoCF_Type	
facets	Kind pattern	Value [0-9]{11}[A-Z]{6}[0-9LMNPQRSTUVWXYZ]{2}[A-Z]{1}[0-9LMNPQRSTUVWXYZ]{2}[A-Z]{1}[0-9LMNPQRSTUVWXYZ]{3}[A-Z]{1}

element **Assegno_Coniuge_Type/Importo**

diagram		
namespace	urn:www.agenziaentrate.gov.it:specificheTecniche:sco:730	
type	DatoNP_Type	
facets	Kind pattern	Value [1-9]{1}[0-9]*

complexType **Bonus_Irpef_Type**

diagram	
namespace	urn:www.agenziaentrate.gov.it:specificheTecniche:sco:730
children	m730:CodiceBonus m730:BonusErogato m730:Esenzione m730:QuotaTfr

element **Bonus_Irpef_Type/CodiceBonus**

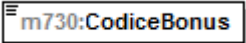
diagram									
namespace	urn:www.agenziaentrate.gov.it:specificheTecniche:sco:730								
type	restriction of DatoN1_Type								
facets	<table border="0"> <tr> <td>Kind</td> <td>Value</td> </tr> <tr> <td>pattern</td> <td>[1-9]</td> </tr> <tr> <td>enumeration</td> <td>1</td> </tr> <tr> <td>enumeration</td> <td>2</td> </tr> </table>	Kind	Value	pattern	[1-9]	enumeration	1	enumeration	2
Kind	Value								
pattern	[1-9]								
enumeration	1								
enumeration	2								

element **Bonus_Irpef_Type/BonusErogato**

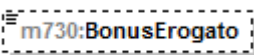
diagram					
namespace	urn:www.agenziaentrate.gov.it:specificheTecniche:sco:730				
type	DatoNP_Type				
facets	<table border="0"> <tr> <td>Kind</td> <td>Value</td> </tr> <tr> <td>pattern</td> <td>[1-9]{1}[0-9]*</td> </tr> </table>	Kind	Value	pattern	[1-9]{1}[0-9]*
Kind	Value				
pattern	[1-9]{1}[0-9]*				

element **Bonus_Irpef_Type/Esenzione**

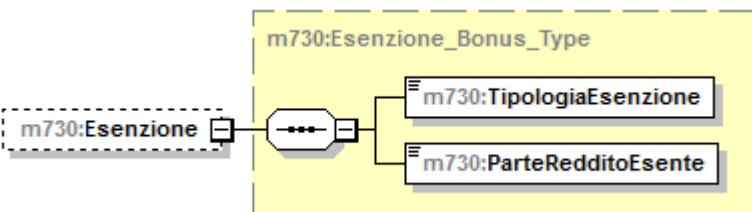
diagram	
namespace	urn:www.agenziaentrate.gov.it:specificheTecniche:sco:730
type	m730:Esenzione_Bonus_Type
children	m730:TipologiaEsenzione m730:ParteRedditoEsente

element **Bonus_Irpef_Type/QuotaTfr**

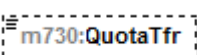
diagram					
namespace	urn:www.agenziaentrate.gov.it:specificheTecniche:sco:730				
type	DatoNP_Type				
facets	<table border="0"> <tr> <td>Kind</td> <td>Value</td> </tr> <tr> <td>pattern</td> <td>[1-9]{1}[0-9]*</td> </tr> </table>	Kind	Value	pattern	[1-9]{1}[0-9]*
Kind	Value				
pattern	[1-9]{1}[0-9]*				

complexType Casella_Aconto_Type

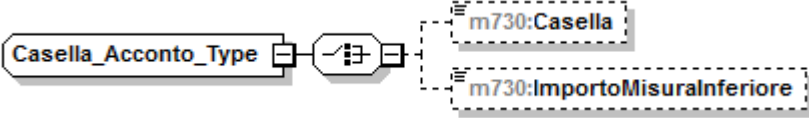
diagram	
namespace	urn:www.agenziaentrate.gov.it:specificheTecniche:sco:730
children	m730:Casella m730:ImportoMisuralInferiore

element Casella_Aconto_Type/Casella

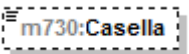
diagram	
namespace	urn:www.agenziaentrate.gov.it:specificheTecniche:sco:730
type	DatoCB_Type
facets	Kind Value pattern [01]

element Casella_Aconto_Type/ImportoMisuralInferiore

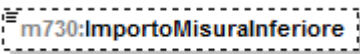
diagram	
namespace	urn:www.agenziaentrate.gov.it:specificheTecniche:sco:730
type	DatoNP_Type
facets	Kind Value pattern [1-9]{1}[0-9]*

complexType Cedolare_Secca_Type

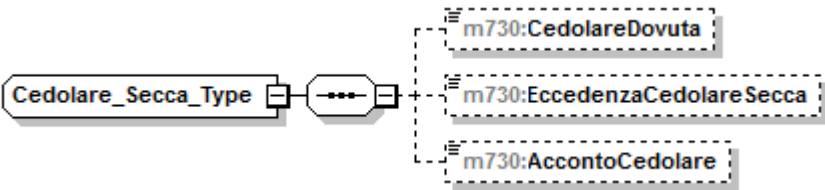
diagram	
namespace	urn:www.agenziaentrate.gov.it:specificheTecniche:sco:730
children	m730:CedolareDovuta m730:EccedenzaCedolareSecca m730:AccontoCedolare

element Cedolare_Secca_Type/CedolareDovuta

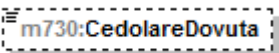
diagram	
namespace	urn:www.agenziaentrate.gov.it:specificheTecniche:sco:730
type	DatoNP_Type
facets	Kind Value pattern [1-9]{1}[0-9]*

element **Cedolare_Secca_Type/EccedenzaCedolareSecca**

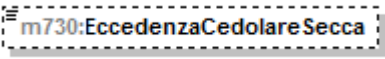
diagram	
namespace	urn:www.agenziaentrate.gov.it:specificheTecniche:sco:730
type	DatoNU_Type
facets	Kind Value pattern $(\backslash-[1-9][1-9])[0-9]^*$

element **Cedolare_Secca_Type/AccontoCedolare**

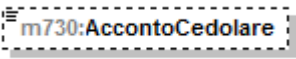
diagram	
namespace	urn:www.agenziaentrate.gov.it:specificheTecniche:sco:730
type	DatoNP_Type
facets	Kind Value pattern $[1-9]\{1\}[0-9]^*$

complexType **Comunicazione_Administratore_Type**

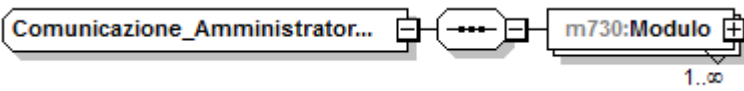
diagram	
namespace	urn:www.agenziaentrate.gov.it:specificheTecniche:sco:730
children	m730:Modulo

element **Comunicazione_Administratore_Type/Modulo**

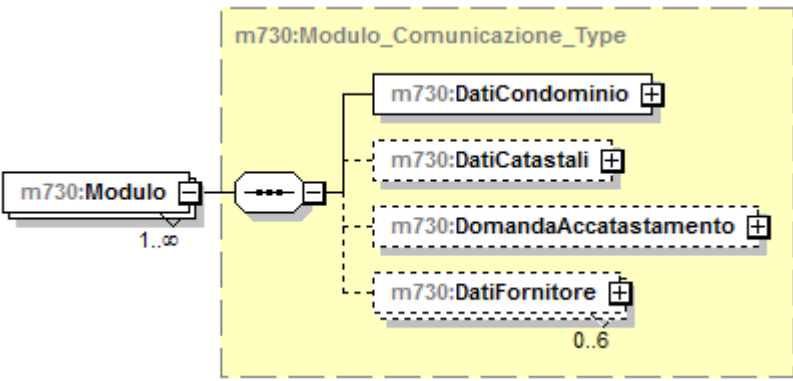
diagram	
namespace	urn:www.agenziaentrate.gov.it:specificheTecniche:sco:730
type	m730:Modulo_Comunicazione_Type
children	m730:DatiCondominio m730:DatiCatastali m730:DomandaAccatastamento m730:DatiFornitore

complexType Conguaglio_Type

diagram	
namespace	urn:www.agenziaentrate.gov.it:specificheTecniche:sco:730
children	m730:NumeroRate m730:ImportoTrattenutoSaldo m730:ImportoTrattenutoAcconto m730:ImportoDaVersareF24Saldo m730:ImportoDaVersareF24Acc... m730:ImportoRimborsato m730:ImportoRimborsatoAgenzia m730:OpzioneInformativa

element Conguaglio_Type/NumeroRate

diagram																	
namespace	urn:www.agenziaentrate.gov.it:specificheTecniche:sco:730																
type	restriction of DatoN1_Type																
facets	<table border="1"> <thead> <tr> <th>Kind</th> <th>Value</th> </tr> </thead> <tbody> <tr> <td>pattern</td> <td>[1-9]</td> </tr> <tr> <td>enumeration</td> <td>2</td> </tr> <tr> <td>enumeration</td> <td>3</td> </tr> <tr> <td>enumeration</td> <td>4</td> </tr> <tr> <td>enumeration</td> <td>5</td> </tr> <tr> <td>enumeration</td> <td>6</td> </tr> <tr> <td>enumeration</td> <td>7</td> </tr> </tbody> </table>	Kind	Value	pattern	[1-9]	enumeration	2	enumeration	3	enumeration	4	enumeration	5	enumeration	6	enumeration	7
Kind	Value																
pattern	[1-9]																
enumeration	2																
enumeration	3																
enumeration	4																
enumeration	5																
enumeration	6																
enumeration	7																

element Conguaglio_Type/ImportoTrattenutoSaldo

diagram					
namespace	urn:www.agenziaentrate.gov.it:specificheTecniche:sco:730				
type	DatoNP_Type				
facets	<table border="1"> <thead> <tr> <th>Kind</th> <th>Value</th> </tr> </thead> <tbody> <tr> <td>pattern</td> <td>[1-9]{1}[0-9]*</td> </tr> </tbody> </table>	Kind	Value	pattern	[1-9]{1}[0-9]*
Kind	Value				
pattern	[1-9]{1}[0-9]*				

element **Conguaglio_Type/ImportoTrattenutoAcconto**

diagram	 m730:ImportoTrattenutoAcconto
namespace	urn:www.agenziaentrate.gov.it:specificheTecniche:sco:730
type	DatoNP_Type
facets	Kind Value pattern [1-9]{1}[0-9]*

element **Conguaglio_Type/ImportoDaVersareF24Saldo**

diagram	 m730:ImportoDaVersareF24Saldo
namespace	urn:www.agenziaentrate.gov.it:specificheTecniche:sco:730
type	DatoNP_Type
facets	Kind Value pattern [1-9]{1}[0-9]*

element **Conguaglio_Type/ImportoDaVersareF24Acconto**

diagram	 m730:ImportoDaVersareF24Acc...
namespace	urn:www.agenziaentrate.gov.it:specificheTecniche:sco:730
type	DatoNP_Type
facets	Kind Value pattern [1-9]{1}[0-9]*

element **Conguaglio_Type/ImportoRimborsato**

diagram	 m730:ImportoRimborsato
namespace	urn:www.agenziaentrate.gov.it:specificheTecniche:sco:730
type	DatoNP_Type
facets	Kind Value pattern [1-9]{1}[0-9]*

element **Conguaglio_Type/ImportoRimborsatoAgenzia**

diagram	 m730:ImportoRimborsatoAgenzia
namespace	urn:www.agenziaentrate.gov.it:specificheTecniche:sco:730
type	DatoNP_Type
facets	Kind Value pattern [1-9]{1}[0-9]*

element **Conguaglio_Type/OpzioneInformativa**

diagram	
namespace	urn:www.agenziaentrate.gov.it:specificheTecniche:sco:730
type	DatoCB_Type
facets	Kind Value pattern [01]

complexType **Contributi_Previdenza_Complementare_Type**

diagram	
namespace	urn:www.agenziaentrate.gov.it:specificheTecniche:sco:730
children	m730:EsclusiDalSostituto m730:NonEsclusiDalSostituto

element **Contributi_Previdenza_Complementare_Type/EsclusiDalSostituto**

diagram	
namespace	urn:www.agenziaentrate.gov.it:specificheTecniche:sco:730
type	DatoNP_Type
facets	Kind Value pattern [1-9]{1}[0-9]*

element **Contributi_Previdenza_Complementare_Type/NonEsclusiDalSostituto**

diagram	
namespace	urn:www.agenziaentrate.gov.it:specificheTecniche:sco:730
type	DatoNP_Type
facets	Kind Value pattern [1-9]{1}[0-9]*

complexType **Contributo_Solidarieta_Type**

diagram	
namespace	urn:www.agenziaentrate.gov.it:specificheTecniche:sco:730
children	m730:ImponibileContributo m730:ContributoDovuto m730:ContributoCertificaz

element **Contributo_Solidarieta_Type/ImponibileContributo**

diagram	
namespace	urn:www.agenziaentrate.gov.it:specificheTecniche:sco:730
type	DatoNP_Type
facets	Kind Value pattern [1-9]{1}[0-9]*

element **Contributo_Solidarieta_Type/ContributoDovuto**

diagram	
namespace	urn:www.agenziaentrate.gov.it:specificheTecniche:sco:730
type	DatoNP_Type
facets	Kind Value pattern [1-9]{1}[0-9]*

element **Contributo_Solidarieta_Type/ContributoCertificaz**

diagram	
namespace	urn:www.agenziaentrate.gov.it:specificheTecniche:sco:730
type	DatoNP_Type
facets	Kind Value pattern [1-9]{1}[0-9]*

complexType **Cred_Erogazione_Cultura_Type**

diagram	
namespace	urn:www.agenziaentrate.gov.it:specificheTecniche:sco:730
children	m730:RataAnnoPrec m730:RataAnno

element **Cred_Erogazione_Cultura_Type/RataAnnoPrec**

diagram	
namespace	urn:www.agenziaentrate.gov.it:specificheTecniche:sco:730
type	DatoNP_Type
facets	Kind Value pattern [1-9]{1}[0-9]*

element Cred_Erogazione_Cultura_Type/RataAnno

diagram	
namespace	urn:www.agenziaentrate.gov.it:specificheTecniche:sco:730
type	DatoNP_Type
facets	Kind Value pattern [1-9]{1}[0-9]*

complexType Cred_Imp_Estero_Type

diagram	
namespace	urn:www.agenziaentrate.gov.it:specificheTecniche:sco:730
children	m730:Anno m730:TotCredito m730:CreditoStato

element Cred_Imp_Estero_Type/Anno

diagram	
namespace	urn:www.agenziaentrate.gov.it:specificheTecniche:sco:730
type	DatoDA_Type
facets	Kind Value pattern (18 19 20)[0-9]{2}

element Cred_Imp_Estero_Type/TotCredito

diagram	
namespace	urn:www.agenziaentrate.gov.it:specificheTecniche:sco:730
type	DatoNP_Type
facets	Kind Value pattern [1-9]{1}[0-9]*

element **Cred_Imp_Estero_Type/CreditoStato**

diagram	
namespace	urn:www.agenziaentrate.gov.it:specificheTecniche:sco:730
type	m730:Credito_Stato_Type
children	m730:Stato m730:Credito

complexType **Crediti_F24_Type**

diagram	
namespace	urn:www.agenziaentrate.gov.it:specificheTecniche:sco:730
children	m730:Credlrpef m730:CredlrpefDipNoSostituto m730:CodAddReg m730:CredAddReg m730:CredAddRegDipNoSostituto m730:CodiceAddCom m730:CredAddCom m730:CredAddComDipNoSostitu... m730:CredCedolare m730:CredCedolareDipNoSostit... m730:CredTassSeparDipNoSosti... m730:CredImpostaSostDipNoSosti... m730:CredSolidarietaDipNoSosti... m730:Totale m730:TotaleDipNoSostituto

element **Crediti_F24_Type/Credlrpef**

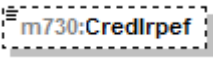
diagram					
namespace	urn:www.agenziaentrate.gov.it:specificheTecniche:sco:730				
type	DatoNP_Type				
facets	<table border="0"> <tr> <td>Kind</td> <td>Value</td> </tr> <tr> <td>pattern</td> <td>[1-9]{1}[0-9]*</td> </tr> </table>	Kind	Value	pattern	[1-9]{1}[0-9]*
Kind	Value				
pattern	[1-9]{1}[0-9]*				

element **Crediti_F24_Type/CredlrpefDipNoSostituto**

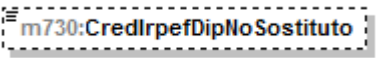
diagram					
namespace	urn:www.agenziaentrate.gov.it:specificheTecniche:sco:730				
type	DatoNP_Type				
facets	<table border="0"> <tr> <td>Kind</td> <td>Value</td> </tr> <tr> <td>pattern</td> <td>[1-9]{1}[0-9]*</td> </tr> </table>	Kind	Value	pattern	[1-9]{1}[0-9]*
Kind	Value				
pattern	[1-9]{1}[0-9]*				

element **Crediti_F24_Type/CodAddReg**

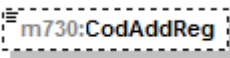
diagram																																															
namespace	urn:www.agenziaentrate.gov.it:specificheTecniche:sco:730																																														
type	Codice Regione Type																																														
facets	<table border="0"> <tr> <td>Kind</td> <td>Value</td> </tr> <tr> <td>pattern</td> <td>([0-9A-Z-] &quot;){1}([0-9A-Z&amp;] ' \"- .!, /° √ \\(\\)À É Ê Ë Ì Ò Ù Û Ü &quot;; \\ / +)*</td> </tr> <tr> <td>enumeration</td> <td>1</td> </tr> <tr> <td>enumeration</td> <td>2</td> </tr> <tr> <td>enumeration</td> <td>3</td> </tr> <tr> <td>enumeration</td> <td>4</td> </tr> <tr> <td>enumeration</td> <td>5</td> </tr> <tr> <td>enumeration</td> <td>6</td> </tr> <tr> <td>enumeration</td> <td>7</td> </tr> <tr> <td>enumeration</td> <td>8</td> </tr> <tr> <td>enumeration</td> <td>9</td> </tr> <tr> <td>enumeration</td> <td>10</td> </tr> <tr> <td>enumeration</td> <td>11</td> </tr> <tr> <td>enumeration</td> <td>12</td> </tr> <tr> <td>enumeration</td> <td>13</td> </tr> <tr> <td>enumeration</td> <td>14</td> </tr> <tr> <td>enumeration</td> <td>15</td> </tr> <tr> <td>enumeration</td> <td>16</td> </tr> <tr> <td>enumeration</td> <td>17</td> </tr> <tr> <td>enumeration</td> <td>18</td> </tr> <tr> <td>enumeration</td> <td>19</td> </tr> <tr> <td>enumeration</td> <td>20</td> </tr> <tr> <td>enumeration</td> <td>21</td> </tr> </table>	Kind	Value	pattern	([0-9A-Z-] "){1}([0-9A-Z&] ' \"- .!, /° √ \\(\\)À É Ê Ë Ì Ò Ù Û Ü "; \\ / +)*	enumeration	1	enumeration	2	enumeration	3	enumeration	4	enumeration	5	enumeration	6	enumeration	7	enumeration	8	enumeration	9	enumeration	10	enumeration	11	enumeration	12	enumeration	13	enumeration	14	enumeration	15	enumeration	16	enumeration	17	enumeration	18	enumeration	19	enumeration	20	enumeration	21
Kind	Value																																														
pattern	([0-9A-Z-] "){1}([0-9A-Z&] ' \"- .!, /° √ \\(\\)À É Ê Ë Ì Ò Ù Û Ü "; \\ / +)*																																														
enumeration	1																																														
enumeration	2																																														
enumeration	3																																														
enumeration	4																																														
enumeration	5																																														
enumeration	6																																														
enumeration	7																																														
enumeration	8																																														
enumeration	9																																														
enumeration	10																																														
enumeration	11																																														
enumeration	12																																														
enumeration	13																																														
enumeration	14																																														
enumeration	15																																														
enumeration	16																																														
enumeration	17																																														
enumeration	18																																														
enumeration	19																																														
enumeration	20																																														
enumeration	21																																														

element **Crediti_F24_Type/CredAddReg**

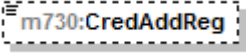
diagram	
namespace	urn:www.agenziaentrate.gov.it:specificheTecniche:sco:730
type	DatoNP_Type
facets	Kind Value pattern [1-9]{1}[0-9]*

element **Crediti_F24_Type/CredAddRegDipNoSostituto**

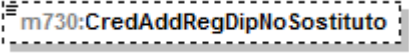
diagram	
namespace	urn:www.agenziaentrate.gov.it:specificheTecniche:sco:730
type	DatoNP_Type
facets	Kind Value pattern [1-9]{1}[0-9]*

element **Crediti_F24_Type/CodiceAddCom**

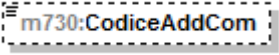
diagram	
namespace	urn:www.agenziaentrate.gov.it:specificheTecniche:sco:730
type	DatoAN_Type
facets	Kind Value pattern ([0-9A-Z\-\-]\"){1}([0-9A-Z&:] ' \- \., / ° °\°\(\) À É È Ì Ò Ù Ú Û " \ \\ \+)*

element **Crediti_F24_Type/CredAddCom**

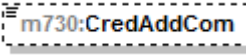
diagram	
namespace	urn:www.agenziaentrate.gov.it:specificheTecniche:sco:730
type	DatoNP_Type
facets	Kind Value pattern [1-9]{1}[0-9]*

element **Crediti_F24_Type/CredAddComDipNoSostituto**

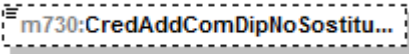
diagram	
namespace	urn:www.agenziaentrate.gov.it:specificheTecniche:sco:730
type	DatoNP_Type
facets	Kind Value pattern [1-9]{1}[0-9]*

element Crediti_F24_Type/CredCedolare

diagram	 m730:CredCedolare				
namespace	urn:www.agenziaentrate.gov.it:specificheTecniche:sco:730				
type	DatoNP_Type				
facets	<table border="1"> <tr> <td>Kind</td> <td>Value</td> </tr> <tr> <td>pattern</td> <td>[1-9]{1}[0-9]*</td> </tr> </table>	Kind	Value	pattern	[1-9]{1}[0-9]*
Kind	Value				
pattern	[1-9]{1}[0-9]*				

element Crediti_F24_Type/CredCedolareDipNoSostituto

diagram	 m730:CredCedolareDipNoSostit...				
namespace	urn:www.agenziaentrate.gov.it:specificheTecniche:sco:730				
type	DatoNP_Type				
facets	<table border="1"> <tr> <td>Kind</td> <td>Value</td> </tr> <tr> <td>pattern</td> <td>[1-9]{1}[0-9]*</td> </tr> </table>	Kind	Value	pattern	[1-9]{1}[0-9]*
Kind	Value				
pattern	[1-9]{1}[0-9]*				

element Crediti_F24_Type/CredTassSeparDipNoSostituto

diagram	 m730:CredTassSeparDipNoSosti...				
namespace	urn:www.agenziaentrate.gov.it:specificheTecniche:sco:730				
type	DatoNP_Type				
facets	<table border="1"> <tr> <td>Kind</td> <td>Value</td> </tr> <tr> <td>pattern</td> <td>[1-9]{1}[0-9]*</td> </tr> </table>	Kind	Value	pattern	[1-9]{1}[0-9]*
Kind	Value				
pattern	[1-9]{1}[0-9]*				

element Crediti_F24_Type/CredImpostaSostDipNoSostituto

diagram	 m730:CredImpostaSostDipNoSo...				
namespace	urn:www.agenziaentrate.gov.it:specificheTecniche:sco:730				
type	DatoNP_Type				
facets	<table border="1"> <tr> <td>Kind</td> <td>Value</td> </tr> <tr> <td>pattern</td> <td>[1-9]{1}[0-9]*</td> </tr> </table>	Kind	Value	pattern	[1-9]{1}[0-9]*
Kind	Value				
pattern	[1-9]{1}[0-9]*				

element Crediti_F24_Type/CredSolidarietaDipNoSostituto

diagram	 m730:CredSolidarietaDipNoSosti...				
namespace	urn:www.agenziaentrate.gov.it:specificheTecniche:sco:730				
type	DatoNP_Type				
facets	<table border="1"> <tr> <td>Kind</td> <td>Value</td> </tr> <tr> <td>pattern</td> <td>[1-9]{1}[0-9]*</td> </tr> </table>	Kind	Value	pattern	[1-9]{1}[0-9]*
Kind	Value				
pattern	[1-9]{1}[0-9]*				

element **Crediti_F24_Type/Totale**

diagram					
namespace	urn:www.agenziaentrate.gov.it:specificheTecniche:sco:730				
type	DatoNP_Type				
facets	<table border="1"> <tr> <td>Kind</td> <td>Value</td> </tr> <tr> <td>pattern</td> <td>[1-9]{1}[0-9]*</td> </tr> </table>	Kind	Value	pattern	[1-9]{1}[0-9]*
Kind	Value				
pattern	[1-9]{1}[0-9]*				

element **Crediti_F24_Type/TotaleDipNoSostituto**

diagram					
namespace	urn:www.agenziaentrate.gov.it:specificheTecniche:sco:730				
type	DatoNP_Type				
facets	<table border="1"> <tr> <td>Kind</td> <td>Value</td> </tr> <tr> <td>pattern</td> <td>[1-9]{1}[0-9]*</td> </tr> </table>	Kind	Value	pattern	[1-9]{1}[0-9]*
Kind	Value				
pattern	[1-9]{1}[0-9]*				

complexType **Crediti_Imposta_Altri_Sisma_Abruzzo_Type**

diagram	
namespace	urn:www.agenziaentrate.gov.it:specificheTecniche:sco:730
children	m730:Impresa_Professione m730:CreditoImmobileSismaAbruzzo m730:Rateazione

element **Crediti_Imposta_Altri_Sisma_Abruzzo_Type/Impresa_Professione**

diagram					
namespace	urn:www.agenziaentrate.gov.it:specificheTecniche:sco:730				
type	DatoCB_Type				
facets	<table border="1"> <tr> <td>Kind</td> <td>Value</td> </tr> <tr> <td>pattern</td> <td>[01]</td> </tr> </table>	Kind	Value	pattern	[01]
Kind	Value				
pattern	[01]				

element **Crediti_Imposta_Altri_Sisma_Abruzzo_Type/CreditoImmobileSismaAbruzzo**

diagram	
namespace	urn:www.agenziaentrate.gov.it:specificheTecniche:sco:730
type	m730:Credito_Immobil..._Sisma_Abruzzo_Type
children	m730:CodiceFiscale m730:NumeroRata m730:TotaleCredito

element **Crediti_Imposta_Altri_Sisma_Abruzzo_Type/Rateazione**

diagram									
namespace	urn:www.agenziaentrate.gov.it:specificheTecniche:sco:730								
type	restriction of DatoNP_Type								
facets	<table border="1"> <thead> <tr> <th>Kind</th> <th>Value</th> </tr> </thead> <tbody> <tr> <td>pattern</td> <td>[1-9]{1}[0-9]*</td> </tr> <tr> <td>enumeration</td> <td>5</td> </tr> <tr> <td>enumeration</td> <td>10</td> </tr> </tbody> </table>	Kind	Value	pattern	[1-9]{1}[0-9]*	enumeration	5	enumeration	10
Kind	Value								
pattern	[1-9]{1}[0-9]*								
enumeration	5								
enumeration	10								

complexType **Crediti_Imposta_Fabbricati_Type**

diagram	
namespace	urn:www.agenziaentrate.gov.it:specificheTecniche:sco:730
children	m730:ResiduoFabbricati m730:CanoniLocazioneNonPercepiti

element **Crediti_Imposta_Fabbricati_Type/ResiduoFabbricati**

diagram	
namespace	urn:www.agenziaentrate.gov.it:specificheTecniche:sco:730

type	m730:Residuo_Fabbricati_Type
children	m730:ResiduoPrecedenteDichiarazione m730:CreditoAnno m730:DiCuiCompensatoF24

element [Crediti_Imposta_Fabbricati_Type/CanoniLocazioneNonPercepti](#)

diagram					
namespace	urn:www.agenziaentrate.gov.it:specificheTecniche:sco:730				
type	DatoNP_Type				
facets	<table border="1"> <thead> <tr> <th>Kind</th> <th>Value</th> </tr> </thead> <tbody> <tr> <td>pattern</td> <td>[1-9]{1}[0-9]*</td> </tr> </tbody> </table>	Kind	Value	pattern	[1-9]{1}[0-9]*
Kind	Value				
pattern	[1-9]{1}[0-9]*				

complexType [Crediti_Imposta_Fondi_Pensione_Type](#)

diagram	
namespace	urn:www.agenziaentrate.gov.it:specificheTecniche:sco:730
children	m730:AnnoAnticipazione m730:Reintegro m730:SommaReintegrata m730:CreditoAnno

element [Crediti_Imposta_Fondi_Pensione_Type/AnnoAnticipazione](#)

diagram																									
namespace	urn:www.agenziaentrate.gov.it:specificheTecniche:sco:730																								
type	m730:Anno_Anticipazione_Fondo_Pensione_Type																								
facets	<table border="1"> <thead> <tr> <th>Kind</th> <th>Value</th> </tr> </thead> <tbody> <tr> <td>pattern</td> <td>[1-9]{1}[0-9]*</td> </tr> <tr> <td>enumeration</td> <td>2007</td> </tr> <tr> <td>enumeration</td> <td>2008</td> </tr> <tr> <td>enumeration</td> <td>2009</td> </tr> <tr> <td>enumeration</td> <td>2010</td> </tr> <tr> <td>enumeration</td> <td>2011</td> </tr> <tr> <td>enumeration</td> <td>2012</td> </tr> <tr> <td>enumeration</td> <td>2013</td> </tr> <tr> <td>enumeration</td> <td>2014</td> </tr> <tr> <td>enumeration</td> <td>2015</td> </tr> <tr> <td>enumeration</td> <td>2016</td> </tr> </tbody> </table>	Kind	Value	pattern	[1-9]{1}[0-9]*	enumeration	2007	enumeration	2008	enumeration	2009	enumeration	2010	enumeration	2011	enumeration	2012	enumeration	2013	enumeration	2014	enumeration	2015	enumeration	2016
Kind	Value																								
pattern	[1-9]{1}[0-9]*																								
enumeration	2007																								
enumeration	2008																								
enumeration	2009																								
enumeration	2010																								
enumeration	2011																								
enumeration	2012																								
enumeration	2013																								
enumeration	2014																								
enumeration	2015																								
enumeration	2016																								

element [Crediti_Imposta_Fondi_Pensione_Type/Reintegro](#)

diagram	
---------	--

namespace	urn:www.agenziaentrate.gov.it:specificheTecniche:sco:730								
type	m730:Reintegro Totale Parziale Type								
facets	<table border="1"> <tr> <td>Kind</td> <td>Value</td> </tr> <tr> <td>pattern</td> <td>[1-9]</td> </tr> <tr> <td>enumeration</td> <td>1</td> </tr> <tr> <td>enumeration</td> <td>2</td> </tr> </table>	Kind	Value	pattern	[1-9]	enumeration	1	enumeration	2
Kind	Value								
pattern	[1-9]								
enumeration	1								
enumeration	2								

element **Crediti Imposta Fondi Pensione Type/SommaReintegrata**

diagram					
namespace	urn:www.agenziaentrate.gov.it:specificheTecniche:sco:730				
type	DatoNP Type				
facets	<table border="1"> <tr> <td>Kind</td> <td>Value</td> </tr> <tr> <td>pattern</td> <td>[1-9]{1}[0-9]*</td> </tr> </table>	Kind	Value	pattern	[1-9]{1}[0-9]*
Kind	Value				
pattern	[1-9]{1}[0-9]*				

element **Crediti Imposta Fondi Pensione Type/CreditoAnno**

diagram					
namespace	urn:www.agenziaentrate.gov.it:specificheTecniche:sco:730				
type	DatoNP Type				
facets	<table border="1"> <tr> <td>Kind</td> <td>Value</td> </tr> <tr> <td>pattern</td> <td>[1-9]{1}[0-9]*</td> </tr> </table>	Kind	Value	pattern	[1-9]{1}[0-9]*
Kind	Value				
pattern	[1-9]{1}[0-9]*				

complexType **Crediti Imposta Redditi Esteri Type**

diagram	
namespace	urn:www.agenziaentrate.gov.it:specificheTecniche:sco:730
children	m730:StatoEstero m730:Anno m730:RedditoEstero m730:ImpostaEstera m730:RedditoComplessivo m730:Imposta_Lorda m730:ImpostaNetta m730:CreditoDichiarazioniPrecedenti m730:DiCuiStatoEstero

element **Crediti_Imposta_Reddito_Esteri_Type/StatoEestero**

diagram	
namespace	urn:www.agenziaentrate.gov.it:specificheTecniche:sco:730
type	DatoAN_Type
facets	Kind Value pattern ([0-9A-Z-] \"){1}([0-9A-Z&:] "- \., / "^\(\\)\) À É È Ì Ò Ù Ú " \ \\ / +)*

element **Crediti_Imposta_Reddito_Esteri_Type/Anno**

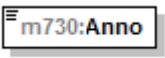
diagram	
namespace	urn:www.agenziaentrate.gov.it:specificheTecniche:sco:730
type	restriction of DatoDA_Type
facets	Kind Value pattern (18 19 20)[0-9]{2}

element **Crediti_Imposta_Reddito_Esteri_Type/RedditoEestero**

diagram	
namespace	urn:www.agenziaentrate.gov.it:specificheTecniche:sco:730
type	DatoNP_Type
facets	Kind Value pattern [1-9]{1}[0-9]*

element **Crediti_Imposta_Reddito_Esteri_Type/ImpostaEsteri**

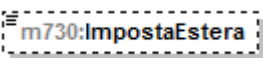
diagram	
namespace	urn:www.agenziaentrate.gov.it:specificheTecniche:sco:730
type	DatoNP_Type
facets	Kind Value pattern [1-9]{1}[0-9]*

element **Crediti_Imposta_Reddito_Esteri_Type/RedditoComplessivo**

diagram	
namespace	urn:www.agenziaentrate.gov.it:specificheTecniche:sco:730
type	DatoNP_Type
facets	Kind Value pattern [1-9]{1}[0-9]*

element **Crediti_Imposta_Redditi_Esteri_Type/Imposta_Lorda**

diagram	
namespace	urn:www.agenziaentrate.gov.it:specificheTecniche:sco:730
type	DatoNP_Type
facets	Kind Value pattern [1-9]{1}[0-9]*

element **Crediti_Imposta_Redditi_Esteri_Type/ImpostaNetta**

diagram	
namespace	urn:www.agenziaentrate.gov.it:specificheTecniche:sco:730
type	DatoNP_Type
facets	Kind Value pattern [1-9]{1}[0-9]*

element **Crediti_Imposta_Redditi_Esteri_Type/CreditoDichiarazioniPrecedenti**

diagram	
namespace	urn:www.agenziaentrate.gov.it:specificheTecniche:sco:730
type	DatoNP_Type
facets	Kind Value pattern [1-9]{1}[0-9]*

element **Crediti_Imposta_Redditi_Esteri_Type/DiCuiStatoEstero**

diagram	
namespace	urn:www.agenziaentrate.gov.it:specificheTecniche:sco:730
type	DatoNP_Type
facets	Kind Value pattern [1-9]{1}[0-9]*

complexType **Crediti_Imposta_Type**

diagram	
namespace	urn:www.agenziaentrate.gov.it:specificheTecniche:sco:730

children	m730:PrimoModulo m730:Modulo
----------	--

element **Crediti_Imposta_Type/PrimoModulo**

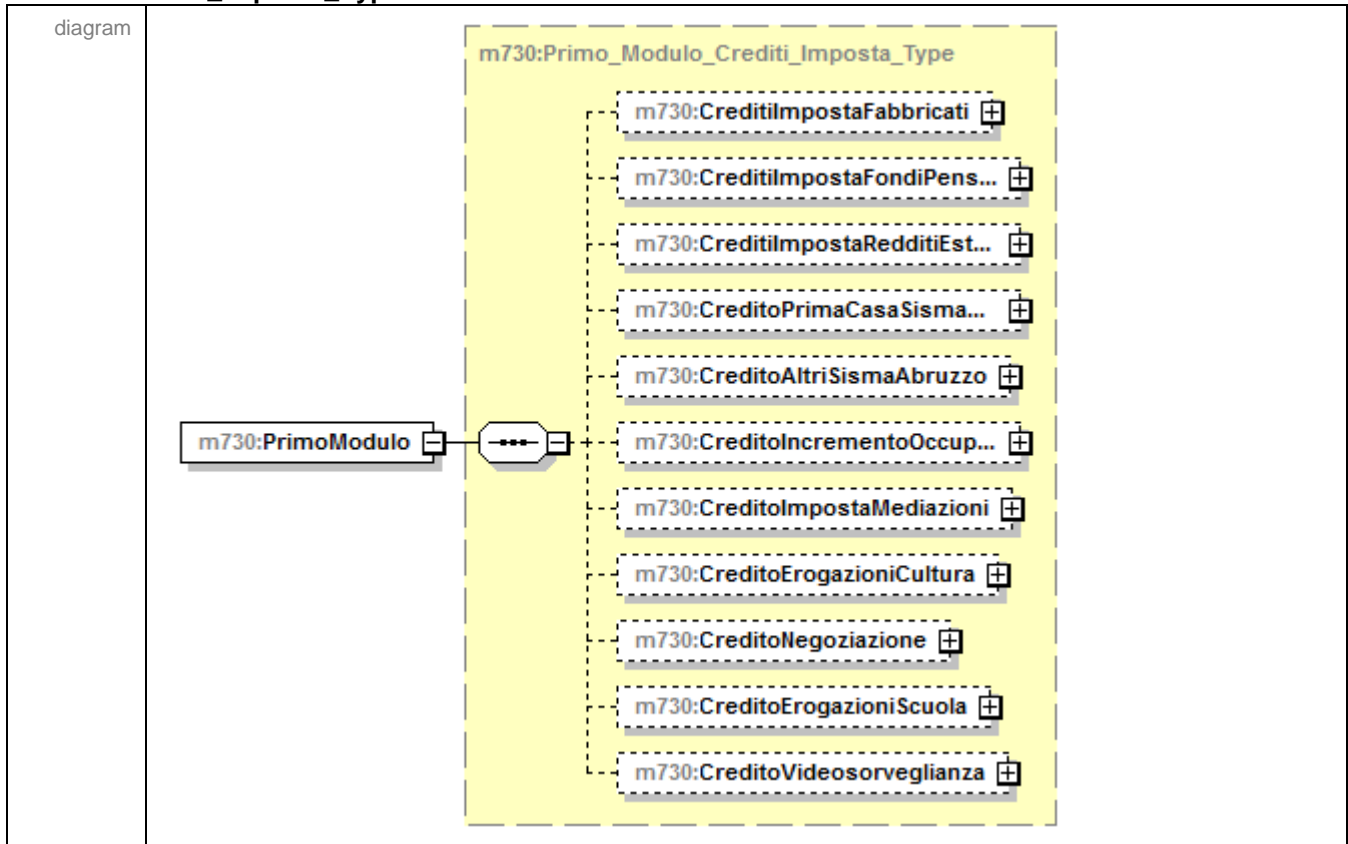

namespace	urn:www.agenziaentrate.gov.it:specificheTecniche:sco:730
-----------	--

type	m730:Primo_Modulo_Crediti_Imposta_Type
------	--

children	m730:CreditoImpostaFabbricati m730:CreditoImpostaFondiPensione m730:CreditoImpostaRedditiEsteri m730:CreditoPrimaCasaSismaAbruzzo m730:CreditoAltriSismaAbruzzo m730:CreditoIncrementoOccupazione m730:CreditoImpostaMediazioni m730:CreditoErogazioniCultura m730:CreditoNegoziazione m730:CreditoErogazioniScuola m730:CreditoVideosorveglianza
----------	---

element **Crediti_Imposta_Type/Modulo**

diagram	
namespace	urn:www.agenziaentrate.gov.it:specificheTecniche:sco:730
type	m730:Modulo_Crediti_Imposta_Type
children	m730:CreditoImpostaFondiPensione m730:CreditoImpostaRedditiEsteri m730:CreditoPrimaCasaSismaAbruzzo m730:CreditoAltriSismaAbruzzo m730:CreditoNegoziazione

complexType **Credito_Erogazioni_Cultura_Type**

diagram	
namespace	urn:www.agenziaentrate.gov.it:specificheTecniche:sco:730
children	m730:SpesaAnno m730:ResiduoAnnoPrec m730:RataAnnoPrec m730:RataDueAnniPrec

element **Credito_Erogazioni_Cultura_Type/SpesaAnno**

diagram					
namespace	urn:www.agenziaentrate.gov.it:specificheTecniche:sco:730				
type	DatoNP_Type				
facets	<table border="1"> <thead> <tr> <th>Kind</th> <th>Value</th> </tr> </thead> <tbody> <tr> <td>pattern</td> <td>[1-9]{1}[0-9]*</td> </tr> </tbody> </table>	Kind	Value	pattern	[1-9]{1}[0-9]*
Kind	Value				
pattern	[1-9]{1}[0-9]*				

element **Credito_Erogazioni_Cultura_Type/ResiduoAnnoPrec**

diagram	
namespace	urn:www.agenziaentrate.gov.it:specificheTecniche:sco:730

type	DatoNP_Type
facets	Kind Value pattern [1-9]{1}[0-9]*

element **Credito_Erogazioni_Cultura_Type/RataAnnoPrec**

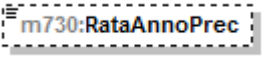
diagram	
namespace	urn:www.agenziaentrate.gov.it:specificheTecniche:sco:730
type	DatoNP_Type
facets	Kind Value pattern [1-9]{1}[0-9]*

element **Credito_Erogazioni_Cultura_Type/RataDueAnniPrec**

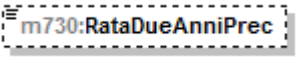
diagram	
namespace	urn:www.agenziaentrate.gov.it:specificheTecniche:sco:730
type	DatoNP_Type
facets	Kind Value pattern [1-9]{1}[0-9]*

complexType **Credito_Erogazioni_Scuola_Type**

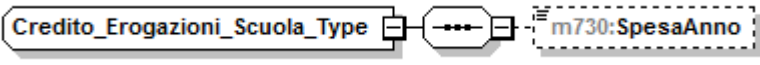
diagram	
namespace	urn:www.agenziaentrate.gov.it:specificheTecniche:sco:730
children	m730:SpesaAnno

element **Credito_Erogazioni_Scuola_Type/SpesaAnno**

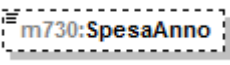
diagram	
namespace	urn:www.agenziaentrate.gov.it:specificheTecniche:sco:730
type	DatoNP_Type
facets	Kind Value pattern [1-9]{1}[0-9]*

complexType Credito_Immobile_Sisma_Abruzzo_Type

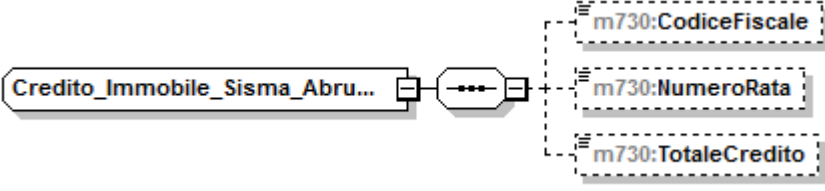
diagram	
namespace	urn:www.agenziaentrate.gov.it:specificheTecniche:sco:730
children	m730:CodiceFiscale m730:NumeroRata m730:TotaleCredito

element Credito_Immobile_Sisma_Abruzzo_Type/CodiceFiscale

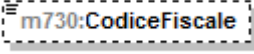
diagram					
namespace	urn:www.agenziaentrate.gov.it:specificheTecniche:sco:730				
type	DatoCF_Type				
facets	<table border="1"> <thead> <tr> <th>Kind</th> <th>Value</th> </tr> </thead> <tbody> <tr> <td>pattern</td> <td>[0-9]{11}[A-Z]{6}[0-9LMNPQRSTU]{2}[A-Z]{1}[0-9LMNPQRSTU]{2}[A-Z]{1}[0-9LMNPQRSTU]{3}[A-Z]{1}</td> </tr> </tbody> </table>	Kind	Value	pattern	[0-9]{11}[A-Z]{6}[0-9LMNPQRSTU]{2}[A-Z]{1}[0-9LMNPQRSTU]{2}[A-Z]{1}[0-9LMNPQRSTU]{3}[A-Z]{1}
Kind	Value				
pattern	[0-9]{11}[A-Z]{6}[0-9LMNPQRSTU]{2}[A-Z]{1}[0-9LMNPQRSTU]{2}[A-Z]{1}[0-9LMNPQRSTU]{3}[A-Z]{1}				

element Credito_Immobile_Sisma_Abruzzo_Type/NumeroRata

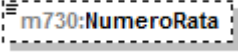
diagram																					
namespace	urn:www.agenziaentrate.gov.it:specificheTecniche:sco:730																				
type	restriction of DatoNP_Type																				
facets	<table border="1"> <thead> <tr> <th>Kind</th> <th>Value</th> </tr> </thead> <tbody> <tr> <td>pattern</td> <td>[1-9]{1}[0-9]*</td> </tr> <tr> <td>enumeration</td> <td>1</td> </tr> <tr> <td>enumeration</td> <td>2</td> </tr> <tr> <td>enumeration</td> <td>3</td> </tr> <tr> <td>enumeration</td> <td>4</td> </tr> <tr> <td>enumeration</td> <td>5</td> </tr> <tr> <td>enumeration</td> <td>6</td> </tr> <tr> <td>enumeration</td> <td>7</td> </tr> <tr> <td>enumeration</td> <td>8</td> </tr> </tbody> </table>	Kind	Value	pattern	[1-9]{1}[0-9]*	enumeration	1	enumeration	2	enumeration	3	enumeration	4	enumeration	5	enumeration	6	enumeration	7	enumeration	8
Kind	Value																				
pattern	[1-9]{1}[0-9]*																				
enumeration	1																				
enumeration	2																				
enumeration	3																				
enumeration	4																				
enumeration	5																				
enumeration	6																				
enumeration	7																				
enumeration	8																				

element Credito_Immobile_Sisma_Abruzzo_Type/TotaleCredito

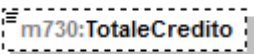
diagram					
namespace	urn:www.agenziaentrate.gov.it:specificheTecniche:sco:730				
type	DatoNP_Type				
facets	<table border="1"> <thead> <tr> <th>Kind</th> <th>Value</th> </tr> </thead> <tbody> <tr> <td>pattern</td> <td>[1-9]{1}[0-9]*</td> </tr> </tbody> </table>	Kind	Value	pattern	[1-9]{1}[0-9]*
Kind	Value				
pattern	[1-9]{1}[0-9]*				

complexType Credito_Incremento_Occupazione_Type

diagram	
namespace	urn:www.agenziaentrate.gov.it:specificheTecniche:sco:730
children	m730:ResiduoPrecedenteDichiarazione m730:DiCuiCompensatoF24

element Credito_Incremento_Occupazione_Type/ResiduoPrecedenteDichiarazione

diagram					
namespace	urn:www.agenziaentrate.gov.it:specificheTecniche:sco:730				
type	DatoNP_Type				
facets	<table border="1"> <tr> <td>Kind</td> <td>Value</td> </tr> <tr> <td>pattern</td> <td>[1-9]{1}[0-9]*</td> </tr> </table>	Kind	Value	pattern	[1-9]{1}[0-9]*
Kind	Value				
pattern	[1-9]{1}[0-9]*				

element Credito_Incremento_Occupazione_Type/DiCuiCompensatoF24

diagram					
namespace	urn:www.agenziaentrate.gov.it:specificheTecniche:sco:730				
type	DatoNP_Type				
facets	<table border="1"> <tr> <td>Kind</td> <td>Value</td> </tr> <tr> <td>pattern</td> <td>[1-9]{1}[0-9]*</td> </tr> </table>	Kind	Value	pattern	[1-9]{1}[0-9]*
Kind	Value				
pattern	[1-9]{1}[0-9]*				

complexType Credito_Negoziazione_Type

diagram	
namespace	urn:www.agenziaentrate.gov.it:specificheTecniche:sco:730
children	m730:CreditoSpettante m730:ResiduoAnnoPrec m730:DiCuiCompensatoF24

element Credito_Negoziazione_Type/CreditoSpettante

diagram					
namespace	urn:www.agenziaentrate.gov.it:specificheTecniche:sco:730				
type	DatoNP_Type				
facets	<table border="1"> <tr> <td>Kind</td> <td>Value</td> </tr> <tr> <td>pattern</td> <td>[1-9]{1}[0-9]*</td> </tr> </table>	Kind	Value	pattern	[1-9]{1}[0-9]*
Kind	Value				
pattern	[1-9]{1}[0-9]*				

element **Credito_Negoziatore_Type/ResiduoAnnoPrec**

diagram	
namespace	urn:www.agenziaentrate.gov.it:specificheTecniche:sco:730
type	DatoNP_Type
facets	Kind Value pattern [1-9]{1}[0-9]*

element **Credito_Negoziatore_Type/DiCuiCompensatoF24**

diagram	
namespace	urn:www.agenziaentrate.gov.it:specificheTecniche:sco:730
type	DatoNP_Type
facets	Kind Value pattern [1-9]{1}[0-9]*

complexType **Credito_Stato_Type**

diagram	
namespace	urn:www.agenziaentrate.gov.it:specificheTecniche:sco:730
children	m730:Stato m730:Credito

element **Credito_Stato_Type/Stato**

diagram	
namespace	urn:www.agenziaentrate.gov.it:specificheTecniche:sco:730
type	DatoAN_Type
facets	Kind Value pattern ([0-9A-Z\-_]"){1}([0-9A-Z&:] ' - \., / "^\(\)\ À É È Ì Ò Ù Û " \\ / +)*

element **Credito_Stato_Type/Credito**

diagram	
namespace	urn:www.agenziaentrate.gov.it:specificheTecniche:sco:730
type	DatoNP_Type
facets	Kind Value pattern [1-9]{1}[0-9]*

complexType Credito_Type

diagram	
namespace	urn:www.agenziaentrate.gov.it:specificheTecniche:sco:730
children	m730:NonRimborsabile m730:Credito m730:CreditoF24 m730:CreditoRimborso

element Credito_Type/NonRimborsabile

diagram					
namespace	urn:www.agenziaentrate.gov.it:specificheTecniche:sco:730				
type	DatoNP_Type				
facets	<table border="1"> <thead> <tr> <th>Kind</th> <th>Value</th> </tr> </thead> <tbody> <tr> <td>pattern</td> <td>[1-9]{1}[0-9]*</td> </tr> </tbody> </table>	Kind	Value	pattern	[1-9]{1}[0-9]*
Kind	Value				
pattern	[1-9]{1}[0-9]*				

element Credito_Type/Credito

diagram					
namespace	urn:www.agenziaentrate.gov.it:specificheTecniche:sco:730				
type	DatoNP_Type				
facets	<table border="1"> <thead> <tr> <th>Kind</th> <th>Value</th> </tr> </thead> <tbody> <tr> <td>pattern</td> <td>[1-9]{1}[0-9]*</td> </tr> </tbody> </table>	Kind	Value	pattern	[1-9]{1}[0-9]*
Kind	Value				
pattern	[1-9]{1}[0-9]*				

element Credito_Type/CreditoF24

diagram					
namespace	urn:www.agenziaentrate.gov.it:specificheTecniche:sco:730				
type	DatoNP_Type				
facets	<table border="1"> <thead> <tr> <th>Kind</th> <th>Value</th> </tr> </thead> <tbody> <tr> <td>pattern</td> <td>[1-9]{1}[0-9]*</td> </tr> </tbody> </table>	Kind	Value	pattern	[1-9]{1}[0-9]*
Kind	Value				
pattern	[1-9]{1}[0-9]*				

element Credito_Type/CreditoRimborso

diagram	
---------	--

namespace	urn:www.agenziaentrate.gov.it:specificheTecniche:sco:730
type	DatoNP_Type
facets	Kind Value pattern [1-9]{1}[0-9]*

complexType Credito_Videosorveglianza_Type

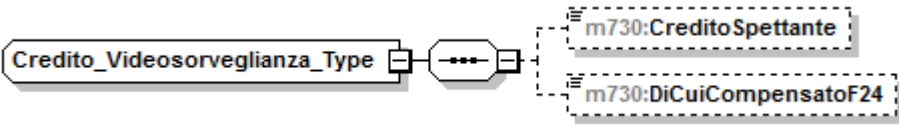
diagram	
namespace	urn:www.agenziaentrate.gov.it:specificheTecniche:sco:730
children	m730:CreditoSpettante m730:DiCuiCompensatoF24

element Credito_Videosorveglianza_Type/CreditoSpettante

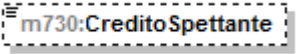
diagram	
namespace	urn:www.agenziaentrate.gov.it:specificheTecniche:sco:730
type	DatoNP_Type
facets	Kind Value pattern [1-9]{1}[0-9]*

element Credito_Videosorveglianza_Type/DiCuiCompensatoF24

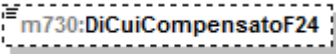
diagram	
namespace	urn:www.agenziaentrate.gov.it:specificheTecniche:sco:730
type	DatoNP_Type
facets	Kind Value pattern [1-9]{1}[0-9]*

complexType Dati_730_Integrativo_Type

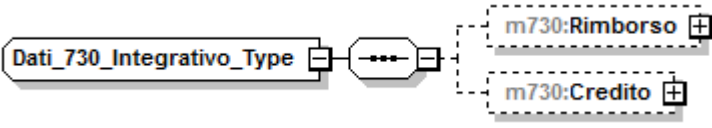
diagram	
namespace	urn:www.agenziaentrate.gov.it:specificheTecniche:sco:730
children	m730:Rimborso m730:Credito

element **Dati_730_Integrativo_Type/Rimborso**

diagram	
namespace	urn:www.agenziaentrate.gov.it:specificheTecniche:sco:730
type	m730:Elemento_Integrativo_Type
children	m730:Irpef m730:AddizionaleRegionaleIrpef m730:AddComunaleIrpef m730:CedolareSecca

element **Dati_730_Integrativo_Type/Credito**

diagram	
namespace	urn:www.agenziaentrate.gov.it:specificheTecniche:sco:730
type	m730:Elemento_Integrativo_Type
children	m730:Irpef m730:AddizionaleRegionaleIrpef m730:AddComunaleIrpef m730:CedolareSecca

complexType **Dati_Altre_Detrazioni_Modulo_Type**

diagram	
namespace	urn:www.agenziaentrate.gov.it:specificheTecniche:sco:730
children	m730:AltreDetrazioni

element **Dati_Altre_Detrazioni_Modulo_Type/AltreDetrazioni**

diagram	
namespace	urn:www.agenziaentrate.gov.it:specificheTecniche:sco:730
type	m730:Altre_Detrazioni_Type
children	m730:Codice m730:Importo

complexType **Dati_Altre_Detrazioni_Type**

diagram	
namespace	urn:www.agenziaentrate.gov.it:specificheTecniche:sco:730
children	m730:SpeseCaniGuida m730:AffittoTerreniAgricoliGiovani m730:AltreDetrazioni

element **Dati_Altre_Detrazioni_Type/SpeseCaniGuida**

diagram					
namespace	urn:www.agenziaentrate.gov.it:specificheTecniche:sco:730				
type	DatoCB_Type				
facets	<table border="1"> <thead> <tr> <th>Kind</th> <th>Value</th> </tr> </thead> <tbody> <tr> <td>pattern</td> <td>[01]</td> </tr> </tbody> </table>	Kind	Value	pattern	[01]
Kind	Value				
pattern	[01]				

element **Dati_Altre_Detrazioni_Type/AffittoTerreniAgricoliGiovani**

diagram					
namespace	urn:www.agenziaentrate.gov.it:specificheTecniche:sco:730				
type	DatoNP_Type				
facets	<table border="1"> <thead> <tr> <th>Kind</th> <th>Value</th> </tr> </thead> <tbody> <tr> <td>pattern</td> <td>[1-9]{1}[0-9]*</td> </tr> </tbody> </table>	Kind	Value	pattern	[1-9]{1}[0-9]*
Kind	Value				
pattern	[1-9]{1}[0-9]*				

element **Dati_Altre_Detrazioni_Type/AltreDetrazioni**

diagram	
namespace	urn:www.agenziaentrate.gov.it:specificheTecniche:sco:730
type	m730:Altre_Detrazioni_Type
children	m730:Codice m730:Importo

complexType **Dati_Associazioni_Professionale_Type**

diagram	
namespace	urn:www.agenziaentrate.gov.it:specificheTecniche:sco:730
children	m730:CFAssociazione m730:DenominazioneAssociazione m730:CFProfessionista m730:CognomeProfessionista m730:NomeProfessionista

element **Dati_Associazioni_Professionale_Type/CFAssociazione**

diagram					
namespace	urn:www.agenziaentrate.gov.it:specificheTecniche:sco:730				
type	DatoCN_Type				
facets	<table border="1"> <thead> <tr> <th>Kind</th> <th>Value</th> </tr> </thead> <tbody> <tr> <td>pattern</td> <td>[0-9]{11}</td> </tr> </tbody> </table>	Kind	Value	pattern	[0-9]{11}
Kind	Value				
pattern	[0-9]{11}				

element **Dati_Associazioni_Professionale_Type/DenominazioneAssociazione**

diagram					
namespace	urn:www.agenziaentrate.gov.it:specificheTecniche:sco:730				
type	DatoAN_Type				
facets	<table border="1"> <thead> <tr> <th>Kind</th> <th>Value</th> </tr> </thead> <tbody> <tr> <td>pattern</td> <td>(([0-9A-Z-] \&quot;){1}([0-9A-Z&amp;#39; ! - \., / ° ^\(\)\ À È É Ì Ò Ù Û &quot; \ \\ / +)*</td> </tr> </tbody> </table>	Kind	Value	pattern	(([0-9A-Z-] \"){1}([0-9A-Z&#39; ! - \., / ° ^\(\)\ À È É Ì Ò Ù Û " \ \\ / +)*
Kind	Value				
pattern	(([0-9A-Z-] \"){1}([0-9A-Z&#39; ! - \., / ° ^\(\)\ À È É Ì Ò Ù Û " \ \\ / +)*				

element **Dati_Associazioni_Professionale_Type/CFProfessionista**

diagram					
namespace	urn:www.agenziaentrate.gov.it:specificheTecniche:sco:730				
type	DatoCF_Type				
facets	<table border="1"> <thead> <tr> <th>Kind</th> <th>Value</th> </tr> </thead> <tbody> <tr> <td>pattern</td> <td>[0-9]{11}[A-Z]{6}[0-9LMNPQRSTU]{2}[A-Z]{1}[0-9LMNPQRSTU]{2}[A-Z]{1}[0-9LMNPQRSTU]{3}[A-Z]{1}</td> </tr> </tbody> </table>	Kind	Value	pattern	[0-9]{11}[A-Z]{6}[0-9LMNPQRSTU]{2}[A-Z]{1}[0-9LMNPQRSTU]{2}[A-Z]{1}[0-9LMNPQRSTU]{3}[A-Z]{1}
Kind	Value				
pattern	[0-9]{11}[A-Z]{6}[0-9LMNPQRSTU]{2}[A-Z]{1}[0-9LMNPQRSTU]{2}[A-Z]{1}[0-9LMNPQRSTU]{3}[A-Z]{1}				

element **Dati_Associazioni_Professionale_Type/CognomeProfessionista**

diagram					
namespace	urn:www.agenziaentrate.gov.it:specificheTecniche:sco:730				
type	DatoAN_Type				
facets	<table border="1"> <thead> <tr> <th>Kind</th> <th>Value</th> </tr> </thead> <tbody> <tr> <td>pattern</td> <td>([0-9A-Z\-\&quot;]{1}){([0-9A-Z&amp;:] \- \., / ^ \^\(\ \) À É È Ì Ò Ù Û &quot; \ \ /+)*</td> </tr> </tbody> </table>	Kind	Value	pattern	([0-9A-Z\-\"]{1}){([0-9A-Z&:] \- \., / ^ \^\(\ \) À É È Ì Ò Ù Û " \ \ /+)*
Kind	Value				
pattern	([0-9A-Z\-\"]{1}){([0-9A-Z&:] \- \., / ^ \^\(\ \) À É È Ì Ò Ù Û " \ \ /+)*				

element **Dati_Associazioni_Professionale_Type/NomeProfessionista**

diagram					
namespace	urn:www.agenziaentrate.gov.it:specificheTecniche:sco:730				
type	DatoAN_Type				
facets	<table border="1"> <thead> <tr> <th>Kind</th> <th>Value</th> </tr> </thead> <tbody> <tr> <td>pattern</td> <td>([0-9A-Z\-\&quot;]{1}){([0-9A-Z&amp;:] \- \., / ^ \^\(\ \) À É È Ì Ò Ù Û &quot; \ \ /+)*</td> </tr> </tbody> </table>	Kind	Value	pattern	([0-9A-Z\-\"]{1}){([0-9A-Z&:] \- \., / ^ \^\(\ \) À É È Ì Ò Ù Û " \ \ /+)*
Kind	Value				
pattern	([0-9A-Z\-\"]{1}){([0-9A-Z&:] \- \., / ^ \^\(\ \) À É È Ì Ò Ù Û " \ \ /+)*				

complexType **Dati_CAF_Type**

diagram	
namespace	urn:www.agenziaentrate.gov.it:specificheTecniche:sco:730
children	m730:CFCaf m730:DenominazioneCaf m730:NumeroAlbo

element **Dati_CAF_Type/CFCaf**

diagram	
namespace	urn:www.agenziaentrate.gov.it:specificheTecniche:sco:730
type	DatoCN_Type

facets	Kind	Value
	pattern	[0-9]{11}

element **Dati_CAF_Type/DenominazioneCaf**

diagram	
namespace	urn:www.agenziaentrate.gov.it:specificheTecniche:sco:730
type	DatoAN_Type
facets	Kind Value pattern (([0-9A-Z-] \"){1}([0-9A-Z&:] \- \., / \°\^\(\)\ À É È Ì Ò Ù Û \" \ \\ \ +)*

element **Dati_CAF_Type/NumeroAlbo**

diagram	
namespace	urn:www.agenziaentrate.gov.it:specificheTecniche:sco:730
type	restriction of DatoNP_Type
facets	Kind Value pattern [1-9]{1}[0-9]*

complexType **Dati_Catastali_Recupero_Patrimonio_Edilizio_Type**

diagram	
namespace	urn:www.agenziaentrate.gov.it:specificheTecniche:sco:730
children	m730:NOrdImmobile m730:Condominio m730:DatiCatastali

element **Dati_Catastali_Recupero_Patrimonio_Edilizio_Type/NOrdImmobile**

diagram	
namespace	urn:www.agenziaentrate.gov.it:specificheTecniche:sco:730
type	DatoNP_Type
facets	Kind Value pattern [1-9]{1}[0-9]*

element **Dati_Catastali_Recupero_Patrimonio_Edilizio_Type/Condominio**

diagram	
---------	--

namespace	urn:www.agenziaentrate.gov.it:specificheTecniche:sco:730	
type	DatoCB_Type	
facets	Kind	Value
	pattern	[01]

element **Dati_Catastali_Recupero_Patrimonio_Edilizio_Type/DatiCatastali**

diagram		
namespace	urn:www.agenziaentrate.gov.it:specificheTecniche:sco:730	
type	m730:Dati_Catastali_Type	
children	m730:CodiceComune m730:TerreniUrbano m730:SezioneUrbanaComuneCatastale m730:Foglio m730:Particella m730:Subalterno	

complexType **Dati_Catastali_Type**

diagram		
namespace	urn:www.agenziaentrate.gov.it:specificheTecniche:sco:730	
children	m730:CodiceComune m730:TerreniUrbano m730:SezioneUrbanaComuneCatastale m730:Foglio m730:Particella m730:Subalterno	

element **Dati_Catastali_Type/CodiceComune**

diagram	
namespace	urn:www.agenziaentrate.gov.it:specificheTecniche:sco:730
type	DatoAN_Type
facets	Kind Value pattern ([0-9A-Z\-\-] "){1}([0-9A-Z&] '\-\-\., /'°\^\(\ \) À È É Ì Ò Ù Û " \ \ \ +)*

element **Dati_Catastali_Type/TerreniUrbano**

diagram	
namespace	urn:www.agenziaentrate.gov.it:specificheTecniche:sco:730
type	m730:Terreni_Urbano_Type
facets	Kind Value pattern ([0-9A-Z\-\-] "){1}([0-9A-Z&] '\-\-\., /'°\^\(\ \) À È É Ì Ò Ù Û " \ \ \ +)* enumeration T enumeration U

element **Dati_Catastali_Type/SezioneUrbanaComuneCatastale**

diagram	
namespace	urn:www.agenziaentrate.gov.it:specificheTecniche:sco:730
type	DatoAN_Type
facets	Kind Value pattern ([0-9A-Z\-\-] "){1}([0-9A-Z&] '\-\-\., /'°\^\(\ \) À È É Ì Ò Ù Û " \ \ \ +)*

element **Dati_Catastali_Type/Foglio**

diagram	
namespace	urn:www.agenziaentrate.gov.it:specificheTecniche:sco:730
type	DatoAN_Type
facets	Kind Value pattern ([0-9A-Z\-\-] "){1}([0-9A-Z&] '\-\-\., /'°\^\(\ \) À È É Ì Ò Ù Û " \ \ \ +)*

element **Dati_Catastali_Type/Particella**

diagram	
namespace	urn:www.agenziaentrate.gov.it:specificheTecniche:sco:730
children	m730:Numeratore m730:Denominatore

element Dati_Catastali_Type/Particella/Numeratore

diagram	
namespace	urn:www.agenziaentrate.gov.it:specificheTecniche:sco:730
type	DatoAN_Type
facets	Kind Value pattern ([0-9A-Z\-\-]*)"}{1}([0-9A-Z&:] ' \"- \". / ' \"^\"\\(\\) À É È Ì Ò Ù Û " \\\" \\+)*

element Dati_Catastali_Type/Particella/Denominatore

diagram	
namespace	urn:www.agenziaentrate.gov.it:specificheTecniche:sco:730
type	DatoAN_Type
facets	Kind Value pattern ([0-9A-Z\-\-]*)"}{1}([0-9A-Z&:] ' \"- \". / ' \"^\"\\(\\) À É È Ì Ò Ù Û " \\\" \\+)*

element Dati_Catastali_Type/Subalterno

diagram	
namespace	urn:www.agenziaentrate.gov.it:specificheTecniche:sco:730
type	DatoAN_Type
facets	Kind Value pattern ([0-9A-Z\-\-]*)"}{1}([0-9A-Z&:] ' \"- \". / ' \"^\"\\(\\) À É È Ì Ò Ù Û " \\\" \\+)*

complexType Dati_Condominio_Type

diagram	
namespace	urn:www.agenziaentrate.gov.it:specificheTecniche:sco:730
children	m730:CodiceFiscale m730:Denominazione

element Dati_Condominio_Type/CodiceFiscale

diagram	
namespace	urn:www.agenziaentrate.gov.it:specificheTecniche:sco:730
type	DatoCF_Type
facets	Kind Value pattern [0-9]{11}[A-Z]{6}[0-9LMNPQRSTUVWXYZ]{2}[A-Z]{1}[0-9LMNPQRSTUVWXYZ]{2}[A-Z]{1}[0-9LMNPQRSTUVWXYZ]{3}[A-Z]{1}

element Dati_Condominio_Type/Denominazione

diagram					
namespace	urn:www.agenziaentrate.gov.it:specificheTecniche:sco:730				
type	DatoAN_Type				
facets	<table border="1"> <tr> <td>Kind</td> <td>Value</td> </tr> <tr> <td>pattern</td> <td>([0-9A-Z\-\-]&quot;){1}([0-9A-Z&amp;:] ' - \., / ^\\(\\ \\) À È É Ì Ò Ù Ú Û&quot; \\ \\ \\+)*</td> </tr> </table>	Kind	Value	pattern	([0-9A-Z\-\-]"){1}([0-9A-Z&:] ' - \., / ^\\(\\ \\) À È É Ì Ò Ù Ú Û" \\ \\ \\+)*
Kind	Value				
pattern	([0-9A-Z\-\-]"){1}([0-9A-Z&:] ' - \., / ^\\(\\ \\) À È É Ì Ò Ù Ú Û" \\ \\ \\+)*				

complexType Dati_Coniuge_Type

diagram	
namespace	urn:www.agenziaentrate.gov.it:specificheTecniche:sco:730
children	m730:Tipo m730:CodiceFiscale m730:Mesi

element Dati_Coniuge_Type/Tipo

diagram					
namespace	urn:www.agenziaentrate.gov.it:specificheTecniche:sco:730				
type	DatoCB_Type				
facets	<table border="1"> <tr> <td>Kind</td> <td>Value</td> </tr> <tr> <td>pattern</td> <td>[01]</td> </tr> </table>	Kind	Value	pattern	[01]
Kind	Value				
pattern	[01]				

element Dati_Coniuge_Type/CodiceFiscale

diagram					
namespace	urn:www.agenziaentrate.gov.it:specificheTecniche:sco:730				
type	DatoCF_Type				
facets	<table border="1"> <tr> <td>Kind</td> <td>Value</td> </tr> <tr> <td>pattern</td> <td>[0-9]{11}[A-Z]{6}[0-9LMNPQRSTUWV]{2}[A-Z]{1}[0-9LMNPQRSTUWV]{2}[A-Z]{1}[0-9LMNPQRSTUWV]{3}[A-Z]{1}</td> </tr> </table>	Kind	Value	pattern	[0-9]{11}[A-Z]{6}[0-9LMNPQRSTUWV]{2}[A-Z]{1}[0-9LMNPQRSTUWV]{2}[A-Z]{1}[0-9LMNPQRSTUWV]{3}[A-Z]{1}
Kind	Value				
pattern	[0-9]{11}[A-Z]{6}[0-9LMNPQRSTUWV]{2}[A-Z]{1}[0-9LMNPQRSTUWV]{2}[A-Z]{1}[0-9LMNPQRSTUWV]{3}[A-Z]{1}				

element Dati_Coniuge_Type/Mesi

diagram	
namespace	urn:www.agenziaentrate.gov.it:specificheTecniche:sco:730
type	m730:Mesi_Type

facets	Kind	Value
	pattern	[1-9]{1}[0-9]*
	enumeration	1
	enumeration	2
	enumeration	3
	enumeration	4
	enumeration	5
	enumeration	6
	enumeration	7
	enumeration	8
	enumeration	9
	enumeration	10
	enumeration	11
	enumeration	12

complexType Dati_Contabili_Type

diagram	
namespace	urn:www.agenziaentrate.gov.it:specificheTecniche:sco:730
children	m730:Familiari m730:QuadroA m730:QuadroB m730:QuadroC m730:QuadroD m730:QuadroE m730:QuadroF m730:QuadroG m730:QuadroI m730:ProspettoLiquidazione m730:Prospetto_Annotazioni m730:QuadroK

element **Dati_Contabili_Type/Familiari**

diagram	
namespace	urn:www.agenziaentrate.gov.it:specificheTecniche:sco:730
type	m730:Familiari_Type
children	m730:PrimoModulo m730:Modulo

element **Dati_Contabili_Type/QuadroA**

diagram	
namespace	urn:www.agenziaentrate.gov.it:specificheTecniche:sco:730
type	m730:Redditi_Terreni_Type
children	m730:Modulo

element **Dati_Contabili_Type/QuadroB**

diagram	
namespace	urn:www.agenziaentrate.gov.it:specificheTecniche:sco:730
type	m730:Redditi_Fabbricati_Type
children	m730:Modulo

element **Dati_Contabili_Type/QuadroC**

diagram	
namespace	urn:www.agenziaentrate.gov.it:specificheTecniche:sco:730
type	m730:Redditi_Lavoro_Dip_Type
children	m730:PrimoModulo m730:Modulo

element **Dati_Contabili_Type/QuadroD**

diagram	
namespace	urn:www.agenziaentrate.gov.it:specificheTecniche:sco:730
type	extension of m730:Altri_Redditi_Type
children	m730:Modulo

element **Dati_Contabili_Type/QuadroE**

diagram	
namespace	urn:www.agenziaentrate.gov.it:specificheTecniche:sco:730
type	m730:Oneri_Type
children	m730:PrimoModulo m730:Modulo

element **Dati Contabili Type/QuadroF**

diagram	
namespace	urn:www.agenziaentrate.gov.it:specificheTecniche:sco:730
type	m730:Acconti_Ritenute_Type
children	m730:PrimoModulo m730:Modulo

element **Dati Contabili Type/QuadroG**

diagram	
namespace	urn:www.agenziaentrate.gov.it:specificheTecniche:sco:730
type	m730:Crediti_Imposta_Type
children	m730:PrimoModulo m730:Modulo

element **Dati Contabili Type/QuadroI**

diagram	
namespace	urn:www.agenziaentrate.gov.it:specificheTecniche:sco:730
type	m730:Quadro_I_Type
children	m730:Importo m730:Casella

element **Dati_Contabili_Type/ProspettoLiquidazione**

diagram	
namespace	urn:www.agenziaentrate.gov.it:specificheTecniche:sco:730
type	m730:Prospetto Liquidazione Type
children	m730:PrimoModulo m730:Modulo

element **Dati_Contabili_Type/Prospetto_Anotazioni**

diagram	
namespace	urn:www.agenziaentrate.gov.it:specificheTecniche:sco:730
type	m730:Prospetto Annotazioni Type
children	m730:Modulo_Anotazioni

element **Dati_Contabili_Type/QuadroK**

diagram	
namespace	urn:www.agenziaentrate.gov.it:specificheTecniche:sco:730
type	m730:Comunicazione Amministratore Type
children	m730:Modulo

complexType Dati_Contratto_Type

diagram	
namespace	urn:www.agenziaentrate.gov.it:specificheTecniche:sco:730
children	m730:DataRegContratto m730:SerieContratto m730:NumeroContratto m730:Sottonumero m730:CodiceUfficio m730:IdentificativoContratto

element Dati_Contratto_Type/DataRegContratto

diagram					
namespace	urn:www.agenziaentrate.gov.it:specificheTecniche:sco:730				
type	DatoDT_Type				
facets	<table border="1"> <thead> <tr> <th>Kind</th> <th>Value</th> </tr> </thead> <tbody> <tr> <td>pattern</td> <td>((([0-9]{1,12} [12][0-9]{3} 01)(0[13578] 10 12)\d{4})) ((([0-9]{1,12} [12][0-9]{30})(0[469] 11)\d{4})) ((([0-9]{1,12} [0-9]{2} [0-8])(02)\d{4})) ((29)(02)([02468][048]00)) ((29)(02)([13579][26]00)) ((29)(02)([0-9][0-9][0-9][0-9][0-9][2468][048])) ((29)(02)([0-9][0-9][13579][26]))</td> </tr> </tbody> </table>	Kind	Value	pattern	((([0-9]{1,12} [12][0-9]{3} 01)(0[13578] 10 12)\d{4})) ((([0-9]{1,12} [12][0-9]{30})(0[469] 11)\d{4})) ((([0-9]{1,12} [0-9]{2} [0-8])(02)\d{4})) ((29)(02)([02468][048]00)) ((29)(02)([13579][26]00)) ((29)(02)([0-9][0-9][0-9][0-9][0-9][2468][048])) ((29)(02)([0-9][0-9][13579][26]))
Kind	Value				
pattern	((([0-9]{1,12} [12][0-9]{3} 01)(0[13578] 10 12)\d{4})) ((([0-9]{1,12} [12][0-9]{30})(0[469] 11)\d{4})) ((([0-9]{1,12} [0-9]{2} [0-8])(02)\d{4})) ((29)(02)([02468][048]00)) ((29)(02)([13579][26]00)) ((29)(02)([0-9][0-9][0-9][0-9][0-9][2468][048])) ((29)(02)([0-9][0-9][13579][26]))				

element Dati_Contratto_Type/SerieContratto

diagram															
namespace	urn:www.agenziaentrate.gov.it:specificheTecniche:sco:730														
type	m730:Serie_Registrazione_Contratto_Type														
facets	<table border="1"> <thead> <tr> <th>Kind</th> <th>Value</th> </tr> </thead> <tbody> <tr> <td>pattern</td> <td>([0-9A-Z-])&quot;{1}([0-9A-Z&amp;:] [-\.,/ ° °\^\\(\) À È É Ì Ò Ù Û &quot; \\ / +)*</td> </tr> <tr> <td>enumeration</td> <td>3</td> </tr> <tr> <td>enumeration</td> <td>3A</td> </tr> <tr> <td>enumeration</td> <td>3B</td> </tr> <tr> <td>enumeration</td> <td>3P</td> </tr> <tr> <td>enumeration</td> <td>3T</td> </tr> </tbody> </table>	Kind	Value	pattern	([0-9A-Z-])"{1}([0-9A-Z&:] [-\.,/ ° °\^\\(\) À È É Ì Ò Ù Û " \\ / +)*	enumeration	3	enumeration	3A	enumeration	3B	enumeration	3P	enumeration	3T
Kind	Value														
pattern	([0-9A-Z-])"{1}([0-9A-Z&:] [-\.,/ ° °\^\\(\) À È É Ì Ò Ù Û " \\ / +)*														
enumeration	3														
enumeration	3A														
enumeration	3B														
enumeration	3P														
enumeration	3T														

element Dati_Contratto_Type/NumeroContratto

diagram	
namespace	urn:www.agenziaentrate.gov.it:specificheTecniche:sco:730
type	DatoAN_Type

facets	Kind	Value
	pattern	(([0-9A-Z\-_]"){1}([0-9A-Z&#39; ! - \., / ° °\(\(\) À È É Ì Ò Ù Û "; \\ / +)*

element Dati_Contratto_Type/Sottonumero

diagram	
namespace	urn:www.agenziaentrate.gov.it:specificheTecniche:sco:730
type	DatoAN_Type
facets	Kind Value pattern (([0-9A-Z\-_]"){1}([0-9A-Z&#39; ! - \., / ° °\(\(\) À È É Ì Ò Ù Û "; \\ / +)*

element Dati_Contratto_Type/CodiceUfficio

diagram	
namespace	urn:www.agenziaentrate.gov.it:specificheTecniche:sco:730
type	restriction of DatoAN_Type
facets	Kind Value pattern (([0-9A-Z\-_]"){1}([0-9A-Z&#39; ! - \., / ° °\(\(\) À È É Ì Ò Ù Û "; \\ / +)*

element Dati_Contratto_Type/IdentificativoContratto

diagram	
namespace	urn:www.agenziaentrate.gov.it:specificheTecniche:sco:730
type	DatoAN_Type
facets	Kind Value pattern (([0-9A-Z\-_]"){1}([0-9A-Z&#39; ! - \., / ° °\(\(\) À È É Ì Ò Ù Û "; \\ / +)*

complexType Dati_Familiare_Type

diagram	
namespace	urn:www.agenziaentrate.gov.it:specificheTecniche:sco:730
children	m730:CodiceFiscale m730:Mesi m730:MesiMinore m730:PercDetraz m730:PercDetrazCon m730:Affidamento

element **Dati_Familiare_Type/CodiceFiscale**

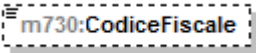
diagram					
namespace	urn:www.agenziaentrate.gov.it:specificheTecniche:sco:730				
type	DatoCF_Type				
facets	<table border="1"> <thead> <tr> <th>Kind</th> <th>Value</th> </tr> </thead> <tbody> <tr> <td>pattern</td> <td>[0-9]{11}[A-Z]{6}[0-9LMNPQRSTUVWXYZ]{2}[A-Z]{1}[0-9LMNPQRSTUVWXYZ]{2}[A-Z]{1}[0-9LMNPQRSTUVWXYZ]{3}[A-Z]{1}</td> </tr> </tbody> </table>	Kind	Value	pattern	[0-9]{11}[A-Z]{6}[0-9LMNPQRSTUVWXYZ]{2}[A-Z]{1}[0-9LMNPQRSTUVWXYZ]{2}[A-Z]{1}[0-9LMNPQRSTUVWXYZ]{3}[A-Z]{1}
Kind	Value				
pattern	[0-9]{11}[A-Z]{6}[0-9LMNPQRSTUVWXYZ]{2}[A-Z]{1}[0-9LMNPQRSTUVWXYZ]{2}[A-Z]{1}[0-9LMNPQRSTUVWXYZ]{3}[A-Z]{1}				

element **Dati_Familiare_Type/Mesi**

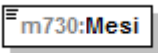
diagram					
namespace	urn:www.agenziaentrate.gov.it:specificheTecniche:sco:730				
type	DatoNP_Type				
facets	<table border="1"> <thead> <tr> <th>Kind</th> <th>Value</th> </tr> </thead> <tbody> <tr> <td>pattern</td> <td>[1-9]{1}[0-9]*</td> </tr> </tbody> </table>	Kind	Value	pattern	[1-9]{1}[0-9]*
Kind	Value				
pattern	[1-9]{1}[0-9]*				

element **Dati_Familiare_Type/MesiMinore**

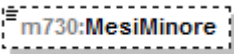
diagram					
namespace	urn:www.agenziaentrate.gov.it:specificheTecniche:sco:730				
type	DatoNP_Type				
facets	<table border="1"> <thead> <tr> <th>Kind</th> <th>Value</th> </tr> </thead> <tbody> <tr> <td>pattern</td> <td>[1-9]{1}[0-9]*</td> </tr> </tbody> </table>	Kind	Value	pattern	[1-9]{1}[0-9]*
Kind	Value				
pattern	[1-9]{1}[0-9]*				

element **Dati_Familiare_Type/PercDetraz**

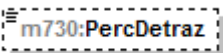
diagram					
namespace	urn:www.agenziaentrate.gov.it:specificheTecniche:sco:730				
type	DatoPC_Type				
facets	<table border="1"> <thead> <tr> <th>Kind</th> <th>Value</th> </tr> </thead> <tbody> <tr> <td>pattern</td> <td>[0-9]?[0-9](, \d{1,3})? 100,(0{1,3})?</td> </tr> </tbody> </table>	Kind	Value	pattern	[0-9]?[0-9](, \d{1,3})? 100,(0{1,3})?
Kind	Value				
pattern	[0-9]?[0-9](, \d{1,3})? 100,(0{1,3})?				

element **Dati_Familiare_Type/PercDetrazCon**

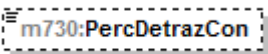
diagram					
namespace	urn:www.agenziaentrate.gov.it:specificheTecniche:sco:730				
type	DatoAN_Type				
facets	<table border="1"> <thead> <tr> <th>Kind</th> <th>Value</th> </tr> </thead> <tbody> <tr> <td>pattern</td> <td>(([0-9A-Z\-_]&quot;){1}([0-9A-Z&amp;#92; ' \- \., / ° '^\(\)\) À É È Ì Ò Ù Û &quot; \\ / +)*</td> </tr> </tbody> </table>	Kind	Value	pattern	(([0-9A-Z\-_]"){1}([0-9A-Z&#92; ' \- \., / ° '^\(\)\) À É È Ì Ò Ù Û " \\ / +)*
Kind	Value				
pattern	(([0-9A-Z\-_]"){1}([0-9A-Z&#92; ' \- \., / ° '^\(\)\) À É È Ì Ò Ù Û " \\ / +)*				

element Dati_Familiare_Type/Affidamento

diagram					
namespace	urn:www.agenziaentrate.gov.it:specificheTecniche:sco:730				
type	DatoCB_Type				
facets	<table border="1"> <thead> <tr> <th>Kind</th> <th>Value</th> </tr> </thead> <tbody> <tr> <td>pattern</td> <td>[01]</td> </tr> </tbody> </table>	Kind	Value	pattern	[01]
Kind	Value				
pattern	[01]				

complexType Dati_Fornitore_Type

diagram	
namespace	urn:www.agenziaentrate.gov.it:specificheTecniche:sco:730
children	m730:CodiceFiscale m730:CognomeDenom m730:Nome m730:Sesso m730:DataNascita m730:ComuneNascita m730:ProvinciaNascita m730:ImportoAcquisti

element Dati_Fornitore_Type/CodiceFiscale

diagram					
namespace	urn:www.agenziaentrate.gov.it:specificheTecniche:sco:730				
type	DatoCF_Type				
facets	<table border="1"> <thead> <tr> <th>Kind</th> <th>Value</th> </tr> </thead> <tbody> <tr> <td>pattern</td> <td>[0-9]{11}[[A-Z]{6}[0-9LMNPQRSTU]{2}[A-Z]{1}[0-9LMNPQRSTU]{2}[A-Z]{1}[0-9LMNPQRSTU]{3}[A-Z]{1}]</td> </tr> </tbody> </table>	Kind	Value	pattern	[0-9]{11}[[A-Z]{6}[0-9LMNPQRSTU]{2}[A-Z]{1}[0-9LMNPQRSTU]{2}[A-Z]{1}[0-9LMNPQRSTU]{3}[A-Z]{1}]
Kind	Value				
pattern	[0-9]{11}[[A-Z]{6}[0-9LMNPQRSTU]{2}[A-Z]{1}[0-9LMNPQRSTU]{2}[A-Z]{1}[0-9LMNPQRSTU]{3}[A-Z]{1}]				

element Dati_Fornitore_Type/CognomeDenom

diagram	
namespace	urn:www.agenziaentrate.gov.it:specificheTecniche:sco:730
type	DatoAN_Type

facets	Kind Value pattern ([0-9A-Z-] "){1}([0-9A-Z&:] ' - \., / ° '¥\(\)\ À È É Ì Ò Ù Û " \ \\ / +)*
--------	--

element Dati_Fornitore_Type/Nome

diagram	
namespace	urn:www.agenziaentrate.gov.it:specificheTecniche:sco:730
type	DatoAN_Type
facets	Kind Value pattern ([0-9A-Z-] "){1}([0-9A-Z&:] ' - \., / ° '¥\(\)\ À È É Ì Ò Ù Û " \ \\ / +)*

element Dati_Fornitore_Type/Sesso

diagram	
namespace	urn:www.agenziaentrate.gov.it:specificheTecniche:sco:730
type	Sesso_Type
facets	Kind Value pattern ([0-9A-Z-] "){1}([0-9A-Z&:] ' - \., / ° '¥\(\)\ À È É Ì Ò Ù Û " \ \\ / +)* enumeration M enumeration F

element Dati_Fornitore_Type/DataNascita

diagram	
namespace	urn:www.agenziaentrate.gov.it:specificheTecniche:sco:730
type	DatoDT_Type
facets	Kind Value pattern (((([0-9][1-9][12][0-9][3][01])(0[13578][10 12](\d{4})) ((([0][1-9][12][0-9][30](0[469][11](\d{4})) ((([0][1-9][1][0-9][2][0-8])(02)(\d{4})) ((29)(02)([02468][048]00)) ((29)(02)([13579][26]00)) ((29)(02)([0-9][0-9][0][48])) ((29)(02)([0-9][0-9][2468][048])) ((29)(02)([0-9][0-9][13579][26]))))

element Dati_Fornitore_Type/ComuneNascita

diagram	
namespace	urn:www.agenziaentrate.gov.it:specificheTecniche:sco:730
type	DatoAN_Type
facets	Kind Value pattern ([0-9A-Z-] "){1}([0-9A-Z&:] ' - \., / ° '¥\(\)\ À È É Ì Ò Ù Û " \ \\ / +)*

element Dati_Fornitore_Type/ProvinciaNascita

diagram	
---------	--

namespace	urn:www.agenziaentrate.gov.it:specificheTecniche:sco:730
type	PN_Type

element Dati_Fornitore_Type/ImportoAcquisti

diagram					
namespace	urn:www.agenziaentrate.gov.it:specificheTecniche:sco:730				
type	DatoNP_Type				
facets	<table border="1"> <tr> <th>Kind</th> <th>Value</th> </tr> <tr> <td>pattern</td> <td>[1-9]{1}[0-9]*</td> </tr> </table>	Kind	Value	pattern	[1-9]{1}[0-9]*
Kind	Value				
pattern	[1-9]{1}[0-9]*				

complexType Dati_Nascita_PF_Type

diagram	
namespace	urn:www.agenziaentrate.gov.it:specificheTecniche:sco:730
children	m730:Sesso m730:DataNascita m730:ComuneNascita m730:ProvinciaNascita

element Dati_Nascita_PF_Type/Sesso

diagram									
namespace	urn:www.agenziaentrate.gov.it:specificheTecniche:sco:730								
type	Sesso_Type								
facets	<table border="1"> <tr> <th>Kind</th> <th>Value</th> </tr> <tr> <td>pattern</td> <td>(([0-9A-Z-~] \&quot;){1}([0-9A-Z&amp;] '\ - \., /° ^\ \(\ \)\ À È É Ì Ò Ù Û &quot; \ \\ /+)*</td> </tr> <tr> <td>enumeration</td> <td>M</td> </tr> <tr> <td>enumeration</td> <td>F</td> </tr> </table>	Kind	Value	pattern	(([0-9A-Z-~] \"){1}([0-9A-Z&] '\ - \., /° ^\ \(\ \)\ À È É Ì Ò Ù Û " \ \\ /+)*	enumeration	M	enumeration	F
Kind	Value								
pattern	(([0-9A-Z-~] \"){1}([0-9A-Z&] '\ - \., /° ^\ \(\ \)\ À È É Ì Ò Ù Û " \ \\ /+)*								
enumeration	M								
enumeration	F								

element Dati_Nascita_PF_Type/DataNascita

diagram					
namespace	urn:www.agenziaentrate.gov.it:specificheTecniche:sco:730				
type	DatoDT_Type				
facets	<table border="1"> <tr> <th>Kind</th> <th>Value</th> </tr> <tr> <td>pattern</td> <td>((([0-9]{1,12}[0-9]{3}[01])(0[13578][1012]\d{4})) ((([0]{1-9}[12][0-9]{30})(0[469][11]\d{4})) ((0[1-9][10-9][2[0-8]](02)\d{4})) ((29)(02)([02468][048]00)) ((29)(02)([13579][26]00)) ((29)(02)([0-9][0-9][048])) ((29)(02)([0-9][0-9][2468][048])) ((29)(02)([0-9][0-9][13579][26]))</td> </tr> </table>	Kind	Value	pattern	((([0-9]{1,12}[0-9]{3}[01])(0[13578][1012]\d{4})) ((([0]{1-9}[12][0-9]{30})(0[469][11]\d{4})) ((0[1-9][10-9][2[0-8]](02)\d{4})) ((29)(02)([02468][048]00)) ((29)(02)([13579][26]00)) ((29)(02)([0-9][0-9][048])) ((29)(02)([0-9][0-9][2468][048])) ((29)(02)([0-9][0-9][13579][26]))
Kind	Value				
pattern	((([0-9]{1,12}[0-9]{3}[01])(0[13578][1012]\d{4})) ((([0]{1-9}[12][0-9]{30})(0[469][11]\d{4})) ((0[1-9][10-9][2[0-8]](02)\d{4})) ((29)(02)([02468][048]00)) ((29)(02)([13579][26]00)) ((29)(02)([0-9][0-9][048])) ((29)(02)([0-9][0-9][2468][048])) ((29)(02)([0-9][0-9][13579][26]))				

element **Dati_Nascita_PF_Type/ComuneNascita**

diagram	
namespace	urn:www.agenziaentrate.gov.it:specificheTecniche:sco:730
type	DatoAN Type
facets	Kind Value pattern ([0-9A-Z\-\]]"){1}([0-9A-Z&]] \-\ \. / ^ \^\(\\ \\) À È É Ì Ò Ù Û " \\ \\ \\ +)*

element **Dati_Nascita_PF_Type/ProvinciaNascita**

diagram	
namespace	urn:www.agenziaentrate.gov.it:specificheTecniche:sco:730
type	PN Type

complexType **Dati_Primo_Figlio_Type**

diagram	
namespace	urn:www.agenziaentrate.gov.it:specificheTecniche:sco:730
children	m730:Tipo m730:CodiceFiscale m730:Mesi m730:MesiMinore m730:PercDetraz m730:Affidamento

element **Dati_Primo_Figlio_Type/Tipo**

diagram	
namespace	urn:www.agenziaentrate.gov.it:specificheTecniche:sco:730
type	restriction of DatoAN Type
facets	Kind Value pattern ([0-9A-Z\-\]]"){1}([0-9A-Z&]] \-\ \. / ^ \^\(\\ \\) À È É Ì Ò Ù Û " \\ \\ \\ +)* enumeration F enumeration D

element **Dati_Primo_Figlio_Type/CodiceFiscale**

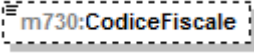
diagram					
namespace	urn:www.agenziaentrate.gov.it:specificheTecniche:sco:730				
type	DatoCF_Type				
facets	<table border="1"> <thead> <tr> <th>Kind</th> <th>Value</th> </tr> </thead> <tbody> <tr> <td>pattern</td> <td>[0-9]{11}[A-Z]{6}[0-9LMNPQRSTU]{2}[A-Z]{1}[0-9LMNPQRSTU]{2}[A-Z]{1}[0-9LMNPQRSTU]{3}[A-Z]{1}</td> </tr> </tbody> </table>	Kind	Value	pattern	[0-9]{11}[A-Z]{6}[0-9LMNPQRSTU]{2}[A-Z]{1}[0-9LMNPQRSTU]{2}[A-Z]{1}[0-9LMNPQRSTU]{3}[A-Z]{1}
Kind	Value				
pattern	[0-9]{11}[A-Z]{6}[0-9LMNPQRSTU]{2}[A-Z]{1}[0-9LMNPQRSTU]{2}[A-Z]{1}[0-9LMNPQRSTU]{3}[A-Z]{1}				

element **Dati_Primo_Figlio_Type/Mesi**

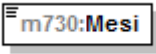
diagram																													
namespace	urn:www.agenziaentrate.gov.it:specificheTecniche:sco:730																												
type	m730:Mesi_Type																												
facets	<table border="1"> <thead> <tr> <th>Kind</th> <th>Value</th> </tr> </thead> <tbody> <tr> <td>pattern</td> <td>[1-9]{1}[0-9]*</td> </tr> <tr> <td>enumeration</td> <td>1</td> </tr> <tr> <td>enumeration</td> <td>2</td> </tr> <tr> <td>enumeration</td> <td>3</td> </tr> <tr> <td>enumeration</td> <td>4</td> </tr> <tr> <td>enumeration</td> <td>5</td> </tr> <tr> <td>enumeration</td> <td>6</td> </tr> <tr> <td>enumeration</td> <td>7</td> </tr> <tr> <td>enumeration</td> <td>8</td> </tr> <tr> <td>enumeration</td> <td>9</td> </tr> <tr> <td>enumeration</td> <td>10</td> </tr> <tr> <td>enumeration</td> <td>11</td> </tr> <tr> <td>enumeration</td> <td>12</td> </tr> </tbody> </table>	Kind	Value	pattern	[1-9]{1}[0-9]*	enumeration	1	enumeration	2	enumeration	3	enumeration	4	enumeration	5	enumeration	6	enumeration	7	enumeration	8	enumeration	9	enumeration	10	enumeration	11	enumeration	12
Kind	Value																												
pattern	[1-9]{1}[0-9]*																												
enumeration	1																												
enumeration	2																												
enumeration	3																												
enumeration	4																												
enumeration	5																												
enumeration	6																												
enumeration	7																												
enumeration	8																												
enumeration	9																												
enumeration	10																												
enumeration	11																												
enumeration	12																												

element **Dati_Primo_Figlio_Type/MesiMinore**

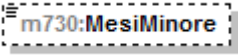
diagram																													
namespace	urn:www.agenziaentrate.gov.it:specificheTecniche:sco:730																												
type	m730:Mesi_Type																												
facets	<table border="1"> <thead> <tr> <th>Kind</th> <th>Value</th> </tr> </thead> <tbody> <tr> <td>pattern</td> <td>[1-9]{1}[0-9]*</td> </tr> <tr> <td>enumeration</td> <td>1</td> </tr> <tr> <td>enumeration</td> <td>2</td> </tr> <tr> <td>enumeration</td> <td>3</td> </tr> <tr> <td>enumeration</td> <td>4</td> </tr> <tr> <td>enumeration</td> <td>5</td> </tr> <tr> <td>enumeration</td> <td>6</td> </tr> <tr> <td>enumeration</td> <td>7</td> </tr> <tr> <td>enumeration</td> <td>8</td> </tr> <tr> <td>enumeration</td> <td>9</td> </tr> <tr> <td>enumeration</td> <td>10</td> </tr> <tr> <td>enumeration</td> <td>11</td> </tr> <tr> <td>enumeration</td> <td>12</td> </tr> </tbody> </table>	Kind	Value	pattern	[1-9]{1}[0-9]*	enumeration	1	enumeration	2	enumeration	3	enumeration	4	enumeration	5	enumeration	6	enumeration	7	enumeration	8	enumeration	9	enumeration	10	enumeration	11	enumeration	12
Kind	Value																												
pattern	[1-9]{1}[0-9]*																												
enumeration	1																												
enumeration	2																												
enumeration	3																												
enumeration	4																												
enumeration	5																												
enumeration	6																												
enumeration	7																												
enumeration	8																												
enumeration	9																												
enumeration	10																												
enumeration	11																												
enumeration	12																												

element **Dati_Primo_Figlio_Type/PercDetraz**

diagram					
namespace	urn:www.agenziaentrate.gov.it:specificheTecniche:sco:730				
type	DatoPC_Type				
facets	<table border="1"> <thead> <tr> <th>Kind</th> <th>Value</th> </tr> </thead> <tbody> <tr> <td>pattern</td> <td>[0-9]?[0-9](,\d{1,3})? 100,0{1,3}?</td> </tr> </tbody> </table>	Kind	Value	pattern	[0-9]?[0-9](,\d{1,3})? 100,0{1,3}?
Kind	Value				
pattern	[0-9]?[0-9](,\d{1,3})? 100,0{1,3}?				

element **Dati_Primo_Figlio_Type/Affidamento**

diagram					
namespace	urn:www.agenziaentrate.gov.it:specificheTecniche:sco:730				
type	DatoCB_Type				
facets	<table border="1"> <thead> <tr> <th>Kind</th> <th>Value</th> </tr> </thead> <tbody> <tr> <td>pattern</td> <td>[01]</td> </tr> </tbody> </table>	Kind	Value	pattern	[01]
Kind	Value				
pattern	[01]				

complexType **Dati_Professionista_Type**

diagram	
namespace	urn:www.agenziaentrate.gov.it:specificheTecniche:sco:730
children	m730:CFProfessionista m730:CognomeProfessionista m730:NomeProfessionista

element **Dati_Professionista_Type/CFProfessionista**

diagram					
namespace	urn:www.agenziaentrate.gov.it:specificheTecniche:sco:730				
type	DatoCF_Type				
facets	<table border="1"> <thead> <tr> <th>Kind</th> <th>Value</th> </tr> </thead> <tbody> <tr> <td>pattern</td> <td>[0-9]{11}[A-Z]{6}[0-9LMNPQRSTUVWXYZ]{2}[A-Z]{1}[0-9LMNPQRSTUVWXYZ]{2}[A-Z]{1}[0-9LMNPQRSTUVWXYZ]{3}[A-Z]{1}</td> </tr> </tbody> </table>	Kind	Value	pattern	[0-9]{11}[A-Z]{6}[0-9LMNPQRSTUVWXYZ]{2}[A-Z]{1}[0-9LMNPQRSTUVWXYZ]{2}[A-Z]{1}[0-9LMNPQRSTUVWXYZ]{3}[A-Z]{1}
Kind	Value				
pattern	[0-9]{11}[A-Z]{6}[0-9LMNPQRSTUVWXYZ]{2}[A-Z]{1}[0-9LMNPQRSTUVWXYZ]{2}[A-Z]{1}[0-9LMNPQRSTUVWXYZ]{3}[A-Z]{1}				

element **Dati_Professionista_Type/CognomeProfessionista**

diagram					
namespace	urn:www.agenziaentrate.gov.it:specificheTecniche:sco:730				
type	DatoAN_Type				
facets	<table border="1"> <thead> <tr> <th>Kind</th> <th>Value</th> </tr> </thead> <tbody> <tr> <td>pattern</td> <td>(([0-9A-Z\-_]&quot;){1}([0-9A-Z&amp;] \- \., / \^\(\ \)\À È É Ì Ò Ù Û &quot; \ \\ / +)*</td> </tr> </tbody> </table>	Kind	Value	pattern	(([0-9A-Z\-_]"){1}([0-9A-Z&] \- \., / \^\(\ \)\À È É Ì Ò Ù Û " \ \\ / +)*
Kind	Value				
pattern	(([0-9A-Z\-_]"){1}([0-9A-Z&] \- \., / \^\(\ \)\À È É Ì Ò Ù Û " \ \\ / +)*				

element **Dati_Professionista_Type/NomeProfessionista**

diagram	
namespace	urn:www.agenziaentrate.gov.it:specificheTecniche:sco:730
type	DatoAN_Type
facets	Kind Value pattern ([0-9A-Z-] \"){1}([0-9A-Z&:] ' \- \., / ^ \^\(\\) À È É Ì Ò Ù Ú " \\ / +)*

complexType **Dati_Registrazione_Accatamento_Recupero_Patrimonio_Edilizio_Type**

diagram	
namespace	urn:www.agenziaentrate.gov.it:specificheTecniche:sco:730
children	m730:NOrdImmobile m730:Condominio m730:EstremiRegistrazioneContratto m730:DomandaAccatamento

element **Dati_Registrazione_Accatamento_Recupero_Patrimonio_Edilizio_Type/NOrdImmobile**

diagram	
namespace	urn:www.agenziaentrate.gov.it:specificheTecniche:sco:730
type	DatoNP_Type
facets	Kind Value pattern [1-9]{1}[0-9]*

element **Dati_Registrazione_Accatamento_Recupero_Patrimonio_Edilizio_Type/Condominio**

diagram	
namespace	urn:www.agenziaentrate.gov.it:specificheTecniche:sco:730
type	DatoCB_Type
facets	Kind Value pattern [01]

element

Dati_Registrazione_Accatastamento_Recupero_Patrimonio_Edilizio_Type/EstremiRegistrazioneContra tto

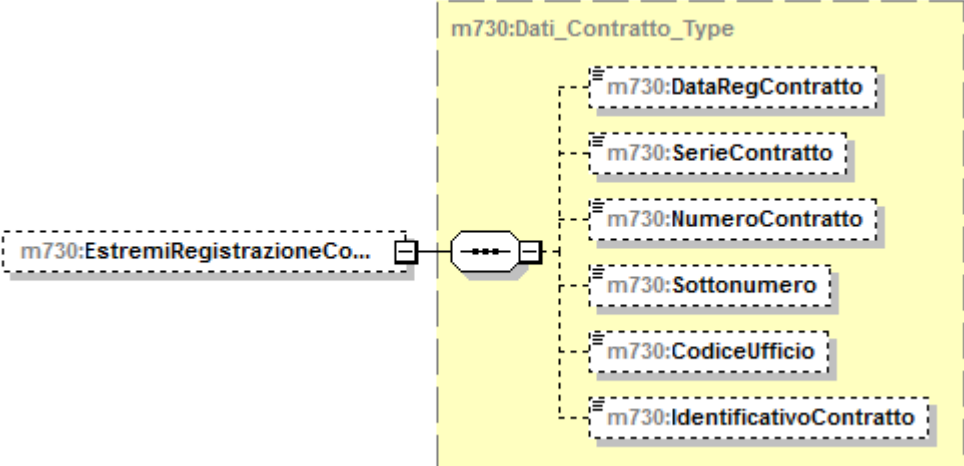
diagram	
namespace	urn:www.agenziaentrate.gov.it:specificheTecniche:sco:730
type	m730:Dati_Contratto_Type
children	m730:DataRegContratto m730:SerieContratto m730:NumeroContratto m730:Sottonumero m730:CodiceUfficio m730:IdentificativoContratto

element

Dati_Registrazione_Accatastamento_Recupero_Patrimonio_Edilizio_Type/DomandaAccatastamento

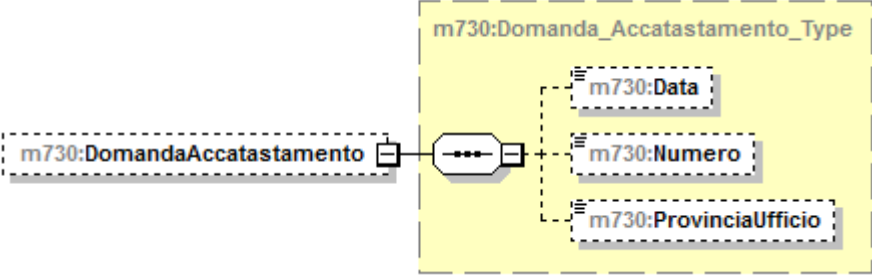
diagram	
namespace	urn:www.agenziaentrate.gov.it:specificheTecniche:sco:730
type	m730:Domanda_Accatastamento_Type
children	m730:Data m730:Numero m730:ProvinciaUfficio

complexType Dati_Rettificati_Type

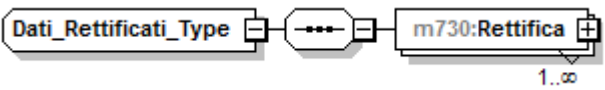
diagram	
namespace	urn:www.agenziaentrate.gov.it:specificheTecniche:sco:730
children	m730:Rettifica

element Dati_Rettificati_Type/Rettifica

diagram	
namespace	urn:www.agenziaentrate.gov.it:specificheTecniche:sco:730
type	m730:Rettifica_Type
children	m730:Quadro m730:Rigo m730:Colonna m730:Modulo m730:DatoRimosso

complexType Debito_Type

diagram	
namespace	urn:www.agenziaentrate.gov.it:specificheTecniche:sco:730
children	m730:NonVersare m730:ImportoDaTrattenere

element Debito_Type/NonVersare

diagram					
namespace	urn:www.agenziaentrate.gov.it:specificheTecniche:sco:730				
type	DatoNP_Type				
facets	<table border="1"> <thead> <tr> <th>Kind</th> <th>Value</th> </tr> </thead> <tbody> <tr> <td>pattern</td> <td>[1-9]{1}[0-9]*</td> </tr> </tbody> </table>	Kind	Value	pattern	[1-9]{1}[0-9]*
Kind	Value				
pattern	[1-9]{1}[0-9]*				

element Debito_Type/ImportoDaTrattenere

diagram					
namespace	urn:www.agenziaentrate.gov.it:specificheTecniche:sco:730				
type	DatoNP_Type				
facets	<table border="1"> <thead> <tr> <th>Kind</th> <th>Value</th> </tr> </thead> <tbody> <tr> <td>pattern</td> <td>[1-9]{1}[0-9]*</td> </tr> </tbody> </table>	Kind	Value	pattern	[1-9]{1}[0-9]*
Kind	Value				
pattern	[1-9]{1}[0-9]*				

complexType Deduzioni_Modulo_Type

diagram	
namespace	urn:www.agenziaentrate.gov.it:specificheTecniche:sco:730
children	m730:AssegnoConiuge m730:AltriOneri m730:AcquistoCostruzioneAbitLocazione

element Deduzioni_Modulo_Type/AssegnoConiuge

diagram	
namespace	urn:www.agenziaentrate.gov.it:specificheTecniche:sco:730
type	m730:Assegno_Coniuge_Type
children	m730:CodiceFiscale m730:Importo

element Deduzioni_Modulo_Type/AltriOneri

diagram	
namespace	urn:www.agenziaentrate.gov.it:specificheTecniche:sco:730
type	m730:Altri_Oneri_Type
children	m730:Codice m730:Importo

element **Deduzioni_Modulo_Type/AcquistoCostruzioneAbitLocazione**

diagram	
namespace	urn:www.agenziaentrate.gov.it:specificheTecniche:sco:730
type	m730:Acquisto_Costruzione_Abit_Type
children	m730:DataStipula m730:Spesa m730:InteressiMutuo

complexType **Deduzioni_Type**

diagram	
namespace	urn:www.agenziaentrate.gov.it:specificheTecniche:sco:730
children	m730:ContributiPrevAss m730:AssegnoConiuge m730:ContributiColf m730:ErogazioniIstituzioniReligiose m730:SpesePortatoriHandicap m730:AltriOneri m730:DeducibilitaOrdinaria m730:LavoratoriPrimaOccupazione m730:FondiInSquilibrioFinanziario m730:FamiliariACarico m730:FondoPensioneDipendentiPubblici m730:AcquistoCostruzioneAbitLocazione m730:RestituzioneSomme

element **Deduzioni_Type/ContributiPrevAss**

diagram					
namespace	urn:www.agenziaentrate.gov.it:specificheTecniche:sco:730				
type	DatoNP_Type				
facets	<table border="1"> <tr> <th>Kind</th> <th>Value</th> </tr> <tr> <td>pattern</td> <td>[1-9]{1}[0-9]*</td> </tr> </table>	Kind	Value	pattern	[1-9]{1}[0-9]*
Kind	Value				
pattern	[1-9]{1}[0-9]*				

element **Deduzioni_Type/AssegnoConiuge**

diagram	
namespace	urn:www.agenziaentrate.gov.it:specificheTecniche:sco:730
type	m730:Assegno_Coniuge_Type
children	m730:CodiceFiscale m730:Importo

element **Deduzioni_Type/ContributiColf**

diagram					
namespace	urn:www.agenziaentrate.gov.it:specificheTecniche:sco:730				
type	DatoNP_Type				
facets	<table border="1"> <tr> <th>Kind</th> <th>Value</th> </tr> <tr> <td>pattern</td> <td>[1-9]{1}[0-9]*</td> </tr> </table>	Kind	Value	pattern	[1-9]{1}[0-9]*
Kind	Value				
pattern	[1-9]{1}[0-9]*				

element **Deduzioni_Type/ErogazioniIstituzioniReligiose**

diagram					
namespace	urn:www.agenziaentrate.gov.it:specificheTecniche:sco:730				
type	DatoNP_Type				
facets	<table border="1"> <tr> <th>Kind</th> <th>Value</th> </tr> <tr> <td>pattern</td> <td>[1-9]{1}[0-9]*</td> </tr> </table>	Kind	Value	pattern	[1-9]{1}[0-9]*
Kind	Value				
pattern	[1-9]{1}[0-9]*				

element **Deduzioni_Type/SpesePortatoriHandicap**

diagram	
namespace	urn:www.agenziaentrate.gov.it:specificheTecniche:sco:730
type	DatoNP_Type

facets	Kind pattern	Value [1-9]{1}[0-9]*
--------	-----------------	-------------------------

element Deduzioni_Type/AltriOneri

diagram	
namespace	urn:www.agenziaentrate.gov.it:specificheTecniche:sco:730
type	m730:Altri_Oneri_Type
children	m730:Codice m730:Importo

element Deduzioni_Type/DeducibilitaOrdinaria

diagram	
namespace	urn:www.agenziaentrate.gov.it:specificheTecniche:sco:730
type	m730:Contributi_Previdenza_Complementare_Type
children	m730:EsclusiDalSostituto m730:NonEsclusiDalSostituto

element Deduzioni_Type/LavoratoriPrimaOccupazione

diagram	
namespace	urn:www.agenziaentrate.gov.it:specificheTecniche:sco:730
type	m730:Contributi_Previdenza_Complementare_Type
children	m730:EsclusiDalSostituto m730:NonEsclusiDalSostituto

element **Deduzioni_Type/FondiInSquilibrioFinanziario**

diagram	
namespace	urn:www.agenziaentrate.gov.it:specificheTecniche:sco:730
type	m730:Contributi Previdenza Complementare Type
children	m730:EsclusiDalSostituto m730:NonEsclusiDalSostituto

element **Deduzioni_Type/FamiliariACarico**

diagram	
namespace	urn:www.agenziaentrate.gov.it:specificheTecniche:sco:730
type	m730:Contributi Previdenza Complementare Type
children	m730:EsclusiDalSostituto m730:NonEsclusiDalSostituto

element **Deduzioni_Type/FondoPensioneDipendentiPubblici**

diagram	
namespace	urn:www.agenziaentrate.gov.it:specificheTecniche:sco:730
type	m730:Fondo_Pensione_Dipendenti_Pubblici Type
children	m730:Contributi m730:QuotaTFR

element **Deduzioni_Type/AcquistoCostruzioneAbitLocazione**

diagram	
namespace	urn:www.agenziaentrate.gov.it:specificheTecniche:sco:730
type	m730:Acquisto Costruzione Abit Type
children	m730:DataStipula m730:Spesa m730:InteressiMutuo

element **Deduzioni_Type/RestituzioneSomme**

diagram	
namespace	urn:www.agenziaentrate.gov.it:specificheTecniche:sco:730
type	m730:Restituzione Somme Type
children	m730:SommeRestituite m730:ResiduoPrecedenteDic

complexType **Detrazione_Crediti_Type**

<p>diagram</p>	
<p>namespace</p>	<p>urn:www.agenziaentrate.gov.it:specificheTecniche:sco:730</p>
<p>children</p>	<p>m730:DetrazioneConiuge m730:DetrazioneFigli m730:UlterioreDetrazioneFigli m730:DetrazioneFamiliari m730:DetrazioneLavDip m730:DetrazionePens m730:DetrazioneAltriRedditi m730:DetrazioneOneri m730:DetrazioneRistrutturazione m730:DetrazioniArredolmmobili m730:DetrazioneRisparmioEnergetico m730:DetrazioneArredoGiovaniCoppie m730:DetrazionelvaAcquistoAbitaz m730:DetrazioneLocEAgricoliGiovani m730:AltreDetrazioni m730:CreditoPrimaCasa m730:CreditoOccupazione m730:CreditoFondiPensione m730:CreditoMediazioni m730:CreditoNegoziazione m730:TotaleDetrazioniCrediti</p>

element **Detrazione_Crediti_Type/DetrazioneConiuge**

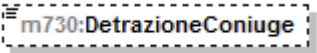
diagram					
namespace	urn:www.agenziaentrate.gov.it:specificheTecniche:sco:730				
type	DatoNP_Type				
facets	<table border="1"> <tr> <td>Kind</td> <td>Value</td> </tr> <tr> <td>pattern</td> <td>[1-9]{1}[0-9]*</td> </tr> </table>	Kind	Value	pattern	[1-9]{1}[0-9]*
Kind	Value				
pattern	[1-9]{1}[0-9]*				

element **Detrazione_Crediti_Type/DetrazioneFigli**

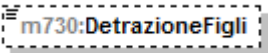
diagram					
namespace	urn:www.agenziaentrate.gov.it:specificheTecniche:sco:730				
type	DatoNP_Type				
facets	<table border="1"> <tr> <td>Kind</td> <td>Value</td> </tr> <tr> <td>pattern</td> <td>[1-9]{1}[0-9]*</td> </tr> </table>	Kind	Value	pattern	[1-9]{1}[0-9]*
Kind	Value				
pattern	[1-9]{1}[0-9]*				

element **Detrazione_Crediti_Type/UlterioreDetrazioneFigli**

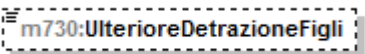
diagram					
namespace	urn:www.agenziaentrate.gov.it:specificheTecniche:sco:730				
type	DatoNP_Type				
facets	<table border="1"> <tr> <td>Kind</td> <td>Value</td> </tr> <tr> <td>pattern</td> <td>[1-9]{1}[0-9]*</td> </tr> </table>	Kind	Value	pattern	[1-9]{1}[0-9]*
Kind	Value				
pattern	[1-9]{1}[0-9]*				

element **Detrazione_Crediti_Type/DetrazioneFamiliari**

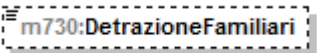
diagram					
namespace	urn:www.agenziaentrate.gov.it:specificheTecniche:sco:730				
type	DatoNP_Type				
facets	<table border="1"> <tr> <td>Kind</td> <td>Value</td> </tr> <tr> <td>pattern</td> <td>[1-9]{1}[0-9]*</td> </tr> </table>	Kind	Value	pattern	[1-9]{1}[0-9]*
Kind	Value				
pattern	[1-9]{1}[0-9]*				

element **Detrazione_Crediti_Type/DetrazioneLavDip**

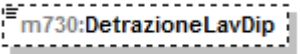
diagram					
namespace	urn:www.agenziaentrate.gov.it:specificheTecniche:sco:730				
type	DatoNP_Type				
facets	<table border="1"> <tr> <td>Kind</td> <td>Value</td> </tr> <tr> <td>pattern</td> <td>[1-9]{1}[0-9]*</td> </tr> </table>	Kind	Value	pattern	[1-9]{1}[0-9]*
Kind	Value				
pattern	[1-9]{1}[0-9]*				

element Detrazione_Crediti_Type/DetrazionePens

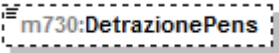
diagram	
namespace	urn:www.agenziaentrate.gov.it:specificheTecniche:sco:730
type	DatoNP_Type
facets	Kind Value pattern [1-9]{1}[0-9]*

element Detrazione_Crediti_Type/DetrazioneAltriRedditi

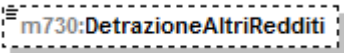
diagram	
namespace	urn:www.agenziaentrate.gov.it:specificheTecniche:sco:730
type	DatoNP_Type
facets	Kind Value pattern [1-9]{1}[0-9]*

element Detrazione_Crediti_Type/DetrazioneOneri

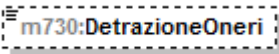
diagram	
namespace	urn:www.agenziaentrate.gov.it:specificheTecniche:sco:730
type	DatoNP_Type
facets	Kind Value pattern [1-9]{1}[0-9]*

element Detrazione_Crediti_Type/DetrazioneRistrutturazione

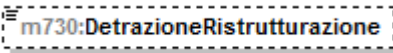
diagram	
namespace	urn:www.agenziaentrate.gov.it:specificheTecniche:sco:730
type	DatoNP_Type
facets	Kind Value pattern [1-9]{1}[0-9]*

element Detrazione_Crediti_Type/DetrazioniArredolImmobili

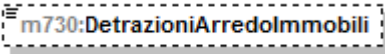
diagram	
namespace	urn:www.agenziaentrate.gov.it:specificheTecniche:sco:730
type	DatoNP_Type
facets	Kind Value pattern [1-9]{1}[0-9]*

element **Detrazione_Crediti_Type/DetrazioneRisparmioEnergetico**

diagram	 m730:DetrazioneRisparmioEner...
namespace	urn:www.agenziaentrate.gov.it:specificheTecniche:sco:730
type	DatoNP_Type
facets	Kind Value pattern [1-9]{1}[0-9]*

element **Detrazione_Crediti_Type/DetrazioneArredoGiovaniCoppie**

diagram	 m730:DetrazioneArredoGiovani...
namespace	urn:www.agenziaentrate.gov.it:specificheTecniche:sco:730
type	DatoNP_Type
facets	Kind Value pattern [1-9]{1}[0-9]*

element **Detrazione_Crediti_Type/DetrazioneIvaAcquistoAbitaz**

diagram	 m730:DetrazioneIvaAcquistoAbit...
namespace	urn:www.agenziaentrate.gov.it:specificheTecniche:sco:730
type	DatoNP_Type
facets	Kind Value pattern [1-9]{1}[0-9]*

element **Detrazione_Crediti_Type/DetrazioneLocEAgricoliGiovani**

diagram	 m730:DetrazioneLocEAgricoliGio...
namespace	urn:www.agenziaentrate.gov.it:specificheTecniche:sco:730
type	DatoNP_Type
facets	Kind Value pattern [1-9]{1}[0-9]*

element **Detrazione_Crediti_Type/AltreDetrazioni**

diagram	 m730:AltreDetrazioni
namespace	urn:www.agenziaentrate.gov.it:specificheTecniche:sco:730
type	DatoNP_Type
facets	Kind Value pattern [1-9]{1}[0-9]*

element Detrazione_Crediti_Type/CreditoPrimaCasa

diagram	
namespace	urn:www.agenziaentrate.gov.it:specificheTecniche:sco:730
type	DatoNP_Type
facets	Kind Value pattern [1-9]{1}[0-9]*

element Detrazione_Crediti_Type/CreditoOccupazione

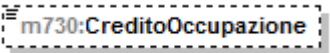
diagram	
namespace	urn:www.agenziaentrate.gov.it:specificheTecniche:sco:730
type	DatoNP_Type
facets	Kind Value pattern [1-9]{1}[0-9]*

element Detrazione_Crediti_Type/CreditoFondiPensione

diagram	
namespace	urn:www.agenziaentrate.gov.it:specificheTecniche:sco:730
type	DatoNP_Type
facets	Kind Value pattern [1-9]{1}[0-9]*

element Detrazione_Crediti_Type/CreditoMediazioni

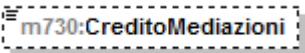
diagram	
namespace	urn:www.agenziaentrate.gov.it:specificheTecniche:sco:730
type	DatoNP_Type
facets	Kind Value pattern [1-9]{1}[0-9]*

element Detrazione_Crediti_Type/CreditoNegoziazione

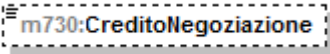
diagram	
namespace	urn:www.agenziaentrate.gov.it:specificheTecniche:sco:730
type	DatoNP_Type
facets	Kind Value pattern [1-9]{1}[0-9]*

element **Detrazione_Crediti_Type/TotaleDetrazioniCrediti**

diagram	
namespace	urn:www.agenziaentrate.gov.it:specificheTecniche:sco:730
type	DatoNP_Type
facets	Kind Value pattern [1-9]{1}[0-9]*

complexType **Detrazioni_Canoni_Locazione_Type**

diagram	
namespace	urn:www.agenziaentrate.gov.it:specificheTecniche:sco:730
children	m730:InquiliniAbitazionePrincipale m730:DipendentiTrasferiti

element **Detrazioni_Canoni_Locazione_Type/InquiliniAbitazionePrincipale**

diagram	
namespace	urn:www.agenziaentrate.gov.it:specificheTecniche:sco:730
type	m730:Inquilini_Abitazione_Principale_Type
children	m730:Tipologia m730:GiorniPercentuale

element **Detrazioni_Canoni_Locazione_Type/DipendentiTrasferiti**

diagram	
namespace	urn:www.agenziaentrate.gov.it:specificheTecniche:sco:730
type	m730:Giorni_Percentuale_Type
children	m730:Giorni m730:Percentuale

complexType **Detrazioni_Modulo_Type**

diagram	
namespace	urn:www.agenziaentrate.gov.it:specificheTecniche:sco:730
children	m730:VeicoliDisabili m730:AcquistoCaniGuida m730:SpeseRateizzate m730:AltreSpese m730:SpeseLeasing

element **Detrazioni_Modulo_Type/VeicoliDisabili**

diagram	
namespace	urn:www.agenziaentrate.gov.it:specificheTecniche:sco:730
type	m730:Spese_Rateizzate_Type
children	m730:Codice m730:Importo

element **Detrazioni_Modulo_Type/AcquistoCaniGuida**

diagram	
namespace	urn:www.agenziaentrate.gov.it:specificheTecniche:sco:730
type	m730:Spese_Rateizzate_Type
children	m730:Codice m730:Importo

element **Detrazioni_Modulo_Type/SpeseRateizzate**

diagram	
namespace	urn:www.agenziaentrate.gov.it:specificheTecniche:sco:730
type	m730:Spese_Rateizzate_Anni_Precedenti_Type
children	m730:Codice m730:Importo

element **Detrazioni_Modulo_Type/AltreSpese**

diagram	
namespace	urn:www.agenziaentrate.gov.it:specificheTecniche:sco:730
type	m730:Altre_Spese_Type
children	m730:Codice m730:Importo

element **Detrazioni_Modulo_Type/SpeseLeasing**

diagram	
namespace	urn:www.agenziaentrate.gov.it:specificheTecniche:sco:730
type	m730:Spese_Leasing_Type
children	m730:DataStipula m730:NumeroAnno m730:Canone m730:PrezzoRiscatto

complexType **Detrazioni_Type**

diagram	
namespace	urn:www.agenziaentrate.gov.it:specificheTecniche:sco:730
children	m730:CasellaRateazione m730:SpeseDeterminatePatologie m730:SpeseSanitarie m730:SpeseFamNonACarico m730:SpeseSanitarieDisabili m730:VeicoliDisabili m730:AcquistoCaniGuida m730:SpeseRateizzate m730:MutuiAbPrincipale m730:AltreSpese m730:SpeseLeasing

element **Detrazioni_Type/CasellaRateazione**

diagram					
namespace	urn:www.agenziaentrate.gov.it:specificheTecniche:sco:730				
type	DatoCB_Type				
facets	<table border="1"> <thead> <tr> <th>Kind</th> <th>Value</th> </tr> </thead> <tbody> <tr> <td>pattern</td> <td>[01]</td> </tr> </tbody> </table>	Kind	Value	pattern	[01]
Kind	Value				
pattern	[01]				

element **Detrazioni_Type/SpeseDeterminatePatologie**

diagram					
namespace	urn:www.agenziaentrate.gov.it:specificheTecniche:sco:730				
type	DatoNP_Type				
facets	<table border="1"> <thead> <tr> <th>Kind</th> <th>Value</th> </tr> </thead> <tbody> <tr> <td>pattern</td> <td>[1-9]{1}[0-9]*</td> </tr> </tbody> </table>	Kind	Value	pattern	[1-9]{1}[0-9]*
Kind	Value				
pattern	[1-9]{1}[0-9]*				

element Detrazioni_Type/SpeseSanitarie

diagram	
namespace	urn:www.agenziaentrate.gov.it:specificheTecniche:sco:730
type	DatoNP_Type
facets	Kind Value pattern [1-9]{1}[0-9]*

element Detrazioni_Type/SpeseFamNonACarico

diagram	
namespace	urn:www.agenziaentrate.gov.it:specificheTecniche:sco:730
type	DatoNP_Type
facets	Kind Value pattern [1-9]{1}[0-9]*

element Detrazioni_Type/SpeseSanitarieDisabili

diagram	
namespace	urn:www.agenziaentrate.gov.it:specificheTecniche:sco:730
type	DatoNP_Type
facets	Kind Value pattern [1-9]{1}[0-9]*

element Detrazioni_Type/VeicoliDisabili

diagram	
namespace	urn:www.agenziaentrate.gov.it:specificheTecniche:sco:730
type	m730:Spese_Rateizzate_Type
children	m730:Codice m730:Importo

element **Detrazioni_Type/AcquistoCaniGuida**

diagram	
namespace	urn:www.agenziaentrate.gov.it:specificheTecniche:sco:730
type	m730:Spese_Rateizzate_Type
children	m730:Codice m730:Importo

element **Detrazioni_Type/SpeseRateizzate**

diagram	
namespace	urn:www.agenziaentrate.gov.it:specificheTecniche:sco:730
type	m730:Spese_Rateizzate_Anni_Precedenti_Type
children	m730:Codice m730:Importo

element **Detrazioni_Type/MutuiAbPrincipale**

diagram					
namespace	urn:www.agenziaentrate.gov.it:specificheTecniche:sco:730				
type	DatoNP_Type				
facets	<table border="1"> <thead> <tr> <th>Kind</th> <th>Value</th> </tr> </thead> <tbody> <tr> <td>pattern</td> <td>[1-9]{1}[0-9]*</td> </tr> </tbody> </table>	Kind	Value	pattern	[1-9]{1}[0-9]*
Kind	Value				
pattern	[1-9]{1}[0-9]*				

element **Detrazioni_Type/AltreSpese**

diagram	
namespace	urn:www.agenziaentrate.gov.it:specificheTecniche:sco:730
type	m730:Altre_Spese_Type

children	m730:Codice m730:Importo
----------	--

element **Detrazioni_Type/SpeseLeasing**

diagram	
namespace	urn:www.agenziaentrate.gov.it:specificheTecniche:sco:730
type	m730:Spese_Leasing_Type
children	m730:DataStipula m730:NumeroAnno m730:Canone m730:PrezzoRiscatto

complexType **Dichiarazione_Con_Type**

diagram	
namespace	urn:www.agenziaentrate.gov.it:specificheTecniche:sco:730
children	m730:Frontespizio m730:DatiContabili m730:FuoriAssistenzaQuadri m730:Scelte

element **Dichiarazione_Con_Type/Frontespizio**

<p>diagram</p>	<pre> classDiagram class m730Frontespizio["m730:Frontespizio"] class m730SoggettoFiscale["m730:SoggettoFiscale"] class m730DatiAnagrafici["m730:DatiAnagrafici"] class m730StatoCivile["m730:StatoCivile"] class m730ResidenzaAnagrafica["m730:ResidenzaAnagrafica"] class m730DomicilioFiscaleSaldo["m730:DomicilioFiscale Saldo"] class m730DomicilioFiscaleAcconto["m730:DomicilioFiscaleAcconto"] class m730CasiParticolariAddizionale["m730:CasiParticolariAddizionale"] class m730Firma["m730:Firma"] m730Frontespizio -- m730SoggettoFiscale m730Frontespizio -- m730DatiAnagrafici m730Frontespizio -- m730StatoCivile m730Frontespizio -- m730ResidenzaAnagrafica m730Frontespizio -- m730DomicilioFiscaleSaldo m730Frontespizio -- m730DomicilioFiscaleAcconto m730Frontespizio -- m730CasiParticolariAddizionale m730Frontespizio -- m730Firma </pre>
<p>namespace</p>	<p>urn:www.agenziaentrate.gov.it:specificheTecniche:sco:730</p>
<p>type</p>	<p>m730:Frontespizio Con Type</p>
<p>children</p>	<p>m730:SoggettoFiscale m730:DatiAnagrafici m730:StatoCivile m730:ResidenzaAnagrafica m730:DomicilioFiscaleSaldo m730:DomicilioFiscaleAcconto m730:CasiParticolariAddizionale m730:Firma</p>

element **Dichiarazione_Con_Type/DatiContabili**

<p>diagram</p>	
<p>namespace</p>	<p>urn:www.agenziaentrate.gov.it:specificheTecniche:sco:730</p>
<p>type</p>	<p>m730:Dati_Contabili_Type</p>
<p>children</p>	<p>m730:Familiari m730:QuadroA m730:QuadroB m730:QuadroC m730:QuadroD m730:QuadroE m730:QuadroF m730:QuadroG m730:QuadroI m730:ProspettoLiquidazione m730:Prospetto_Annotazioni m730:QuadroK</p>

element **Dichiarazione_Con_Type/FuoriAssistenzaQuadri**

<p>diagram</p>	
----------------	--

namespace	urn:www.agenziaentrate.gov.it:specificheTecniche:sco:730
type	m730:Fuori_Assistenza_Type
children	m730:AnomaliaDatianagrafici m730:AnomaliaTerreni m730:AnomaliaFabbricati m730:AnomaliaLavDip m730:AnomaliaAltriRedditi m730:AnomaliaQuadroF

element Dichiarazione_Con_Type/Scelte

diagram	
namespace	urn:www.agenziaentrate.gov.it:specificheTecniche:sco:730
type	sce:Scelte_Type
children	sce:Scelta5PerMille sce:Scelta8PerMille sce:Scelta2PerMille

complexType Dichiarazione_Dich_Type

diagram	
namespace	urn:www.agenziaentrate.gov.it:specificheTecniche:sco:730
children	m730:Frontespizio m730:DatiContabili m730:FuoriAssistenza m730:Scelte

element **Dichiarazione_Dich_Type/Frontespizio**

<p>diagram</p>	<p>The diagram illustrates the structure of the m730:Frontespizio_Dich_Type (extension) element. It shows a root element m730:Frontespizio which is connected to a container element. This container element branches into two paths: one leading to a sequence of elements (m730:SoggettoFiscale, m730:DatiAnagrafici, m730:StatoCivile, m730:ResidenzaAnagrafica, m730:DomicilioFiscaleSaldo, m730:DomicilioFiscaleAcconto, m730:CasiParticolariAddizionale) and another leading to m730:Firma. A second container element is connected to m730:Firma and leads to m730:Rappresentante.</p>
<p>namespace</p>	<p>urn:www.agenziaentrate.gov.it:specificheTecniche:sco:730</p>
<p>type</p>	<p>extension of m730:Frontespizio Dich_Type</p>
<p>children</p>	<p>m730:SoggettoFiscale m730:DatiAnagrafici m730:StatoCivile m730:ResidenzaAnagrafica m730:DomicilioFiscaleSaldo m730:DomicilioFiscaleAcconto m730:CasiParticolariAddizionale m730:Firma m730:Rappresentante</p>

element Dichiarazione_Dich_Type/DatiContabili

<p>diagram</p>	
<p>namespace</p>	<p>urn:www.agenziaentrate.gov.it:specificheTecniche:sco:730</p>
<p>type</p>	<p>m730:Dati_Contabili_Type</p>
<p>children</p>	<p>m730:Familiari m730:QuadroA m730:QuadroB m730:QuadroC m730:QuadroD m730:QuadroE m730:QuadroF m730:QuadroG m730:QuadroI m730:ProspettoLiquidazione m730:Prospetto_Annotazioni m730:QuadroK</p>

element Dichiarazione_Dich_Type/FuoriAssistenza

<p>diagram</p>	
<p>namespace</p>	<p>urn:www.agenziaentrate.gov.it:specificheTecniche:sco:730</p>
<p>children</p>	<p>m730:FuoriAssistenzaQuadri m730:AnomaliaDatiSostituto m730:AnomaliaDatiRappresentante</p>

element **Dichiarazione_Dich_Type/FuoriAssistenza/FuoriAssistenzaQuadri**

diagram	
namespace	urn:www.agenziaentrate.gov.it:specificheTecniche:sco:730
type	m730:Fuori_Assistenza_Type
children	m730:AnomaliaDatianagrafici m730:AnomaliaTerreni m730:AnomaliaFabbricati m730:AnomaliaLavDip m730:AnomaliaAltriRedditi m730:AnomaliaQuadroF

element **Dichiarazione_Dich_Type/FuoriAssistenza/AnomaliaDatiSostituto**

diagram					
namespace	urn:www.agenziaentrate.gov.it:specificheTecniche:sco:730				
type	DatoCB_Type				
facets	<table border="1"> <tr> <td>Kind</td> <td>Value</td> </tr> <tr> <td>pattern</td> <td>[01]</td> </tr> </table>	Kind	Value	pattern	[01]
Kind	Value				
pattern	[01]				

element **Dichiarazione_Dich_Type/FuoriAssistenza/AnomaliaDatiRappresentante**

diagram					
namespace	urn:www.agenziaentrate.gov.it:specificheTecniche:sco:730				
type	DatoCB_Type				
facets	<table border="1"> <tr> <td>Kind</td> <td>Value</td> </tr> <tr> <td>pattern</td> <td>[01]</td> </tr> </table>	Kind	Value	pattern	[01]
Kind	Value				
pattern	[01]				

element **Dichiarazione_Dich_Type/Scelte**

diagram	
namespace	urn:www.agenziaentrate.gov.it:specificheTecniche:sco:730
type	sce:Scelte_Type
children	sce:Scelta5PerMille sce:Scelta8PerMille sce:Scelta2PerMille

complexType **Documento_730-4**

diagram	
namespace	urn:www.agenziaentrate.gov.it:specificheTecniche:sco:730
children	m730:DatiAnagraficiDichiarante m730:Sostituto m730:SoggettoAssFiscale730-4 m730:AltriDati m730:DatiContabili730-4

element **Documento_730-4/DatiAnagraficiDichiarante**

diagram	
namespace	urn:www.agenziaentrate.gov.it:specificheTecniche:sco:730
type	extension of Dati_Anagrafici_Type
children	Cognome Nome Sesso DataNascita ComuneNascita ProvinciaNascita m730:CFDichiarante

element **Documento_730-4/DatiAnagraficiDichiarante/CFDichiarante**

diagram					
namespace	urn:www.agenziaentrate.gov.it:specificheTecniche:sco:730				
type	DatoCF_Type				
facets	<table border="1"> <thead> <tr> <th>Kind</th> <th>Value</th> </tr> </thead> <tbody> <tr> <td>pattern</td> <td>[0-9]{11}[A-Z]{6}[0-9LMNPQRSTUUV]{2}[A-Z]{1}[0-9LMNPQRSTUUV]{2}[A-Z]{1}[0-9LMNPQRSTUUV]{3}[A-Z]{1}</td> </tr> </tbody> </table>	Kind	Value	pattern	[0-9]{11}[A-Z]{6}[0-9LMNPQRSTUUV]{2}[A-Z]{1}[0-9LMNPQRSTUUV]{2}[A-Z]{1}[0-9LMNPQRSTUUV]{3}[A-Z]{1}
Kind	Value				
pattern	[0-9]{11}[A-Z]{6}[0-9LMNPQRSTUUV]{2}[A-Z]{1}[0-9LMNPQRSTUUV]{2}[A-Z]{1}[0-9LMNPQRSTUUV]{3}[A-Z]{1}				

element **Documento_730-4/Sostituto**

diagram	
---------	--

namespace	urn:www.agenziaentrate.gov.it:specificheTecniche:sco:730
type	m730:Sostituto_Type
children	m730:CodiceFiscale m730:DatiAnagraficiPF m730:DenominazionePNF m730:Residenza m730:Fax m730:CodiceSede

element **Documento_730-4/SoggettoAssFiscale730-4**

diagram	
namespace	urn:www.agenziaentrate.gov.it:specificheTecniche:sco:730
children	m730:DatiCaf730-4 m730:DatiProfessionista730-4 m730:DatiAssociazione730-4 m730:DatiAgenzia730-4

element **Documento_730-4/SoggettoAssFiscale730-4/DatiCaf730-4**

diagram	
namespace	urn:www.agenziaentrate.gov.it:specificheTecniche:sco:730
type	extension of m730:Dati_CAF_Type
children	m730:CFCaf m730:DenominazioneCaf m730:NumeroAlbo m730:DomicilioCaf m730:UfficioPerifericoCaf

element **Documento_730-4/SoggettoAssFiscale730-4/DatiCaf730-4/DomicilioCaf**

diagram	
namespace	urn:www.agenziaentrate.gov.it:specificheTecniche:sco:730
type	m730:Domicilio Sogg Ass Fiscale Type
children	m730:Comune m730:Provincia m730:CodiceComune m730:Cap m730:Indirizzo m730:Telefono m730:FAX m730:Email

element **Documento_730-4/SoggettoAssFiscale730-4/DatiCaf730-4/UfficioPerifericoCaf**

diagram	
namespace	urn:www.agenziaentrate.gov.it:specificheTecniche:sco:730
children	m730:DomicilioUffPeriferico

element Documento_730-4/SoggettoAssFiscale730-4/DatiCaf730-4/UfficioPerifericoCaf/DomicilioUffPeriferico

diagram	
namespace	urn:www.agenziaentrate.gov.it:specificheTecniche:sco:730
type	extension of m730:Domicilio_Sogg_Ass_Fiscale_Type
children	m730:Comune m730:Provincia m730:CodiceComune m730:Cap m730:Indirizzo m730:Telefono m730:FAX m730:Email m730:CodiceSedePeriferica

element Documento_730-4/SoggettoAssFiscale730-4/DatiCaf730-4/UfficioPerifericoCaf/DomicilioUffPeriferico/CodiceSedePeriferica

diagram					
namespace	urn:www.agenziaentrate.gov.it:specificheTecniche:sco:730				
type	DatoAN_Type				
facets	<table border="1"> <thead> <tr> <th>Kind</th> <th>Value</th> </tr> </thead> <tbody> <tr> <td>pattern</td> <td>([0-9A-Z-] \&quot;){1}([0-9A-Z&amp;] ! - \., / °\^\(\ \)\À È É Ì Ò Ù Û &quot; \N \+)*</td> </tr> </tbody> </table>	Kind	Value	pattern	([0-9A-Z-] \"){1}([0-9A-Z&] ! - \., / °\^\(\ \)\À È É Ì Ò Ù Û " \N \+)*
Kind	Value				
pattern	([0-9A-Z-] \"){1}([0-9A-Z&] ! - \., / °\^\(\ \)\À È É Ì Ò Ù Û " \N \+)*				

element **Documento_730-4/SoggettoAssFiscale730-4/DatiProfessionista730-4**

diagram	<p>The diagram shows a class <code>m730:DatiProfessionista730-4</code> extending the class <code>m730:Dati_Professionista_Type (extension)</code>. The extension includes four child elements: <code>m730:CFProfessionista</code>, <code>m730:CognomeProfessionista</code>, <code>m730:NomeProfessionista</code>, and <code>m730:DomicilioProf</code>.</p>
namespace	urn:www.agenziaentrate.gov.it:specificheTecniche:sco:730
type	extension of m730:Dati Professionista Type
children	m730:CFProfessionista m730:CognomeProfessionista m730:NomeProfessionista m730:DomicilioProf

element **Documento_730-4/SoggettoAssFiscale730-4/DatiProfessionista730-4/DomicilioProf**

diagram	<p>The diagram shows a class <code>m730:DomicilioProf</code> extending the class <code>m730:Domicilio_Sogg_Ass_Fiscale_Type</code>. The extension includes eight child elements: <code>m730:Comune</code>, <code>m730:Provincia</code>, <code>m730:CodiceComune</code>, <code>m730:Cap</code>, <code>m730:Indirizzo</code>, <code>m730:Telefono</code>, <code>m730:FAX</code>, and <code>m730:Email</code>.</p>
namespace	urn:www.agenziaentrate.gov.it:specificheTecniche:sco:730
type	m730:Domicilio Sogg Ass Fiscale Type
children	m730:Comune m730:Provincia m730:CodiceComune m730:Cap m730:Indirizzo m730:Telefono m730:FAX m730:Email

element **Documento_730-4/SoggettoAssFiscale730-4/DatiAssociazione730-4**

diagram	<p>The diagram shows a class <code>m730:DatiAssociazione730-4</code> extending the class <code>m730:Dati_Associazioni_Professionale_Type</code>. The extension is highlighted in a yellow dashed box and includes the following elements: <code>m730:CFAssociazione</code>, <code>m730:DenominazioneAssociazione</code>, <code>m730:CFProfessionista</code>, <code>m730:CognomeProfessionista</code>, <code>m730:NomeProfessionista</code>, and <code>m730:DomicilioAssociazione</code>.</p>
namespace	urn:www.agenziaentrate.gov.it:specificheTecniche:sco:730
type	extension of m730:Dati_Associazioni_Professionale_Type
children	m730:CFAssociazione m730:DenominazioneAssociazione m730:CFProfessionista m730:CognomeProfessionista m730:NomeProfessionista m730:DomicilioAssociazione

element **Documento_730-4/SoggettoAssFiscale730-4/DatiAssociazione730-4/DomicilioAssociazione**

diagram	<p>The diagram shows a class <code>m730:DomicilioAssociazione</code> extending the class <code>m730:Domicilio_Sogg_Ass_Fiscale_Type</code>. The extension is highlighted in a yellow dashed box and includes the following elements: <code>m730:Comune</code>, <code>m730:Provincia</code>, <code>m730:CodiceComune</code>, <code>m730:Cap</code>, <code>m730:Indirizzo</code>, <code>m730:Telefono</code>, <code>m730:FAX</code>, and <code>m730:Email</code>.</p>
namespace	urn:www.agenziaentrate.gov.it:specificheTecniche:sco:730
type	m730:Domicilio_Sogg_Ass_Fiscale_Type
children	m730:Comune m730:Provincia m730:CodiceComune m730:Cap m730:Indirizzo m730:Telefono m730:FAX m730:Email

element **Documento_730-4/SoggettoAssFiscale730-4/DatiAgenzia730-4**

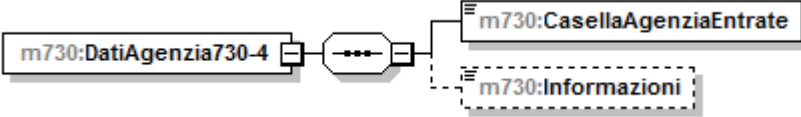
diagram	
namespace	urn:www.agenziaentrate.gov.it:specificheTecniche:sco:730
children	m730:CasellaAgenziaEntrate m730:Informazioni

element **Documento_730-4/SoggettoAssFiscale730-4/DatiAgenzia730-4/CasellaAgenziaEntrate**

diagram	
namespace	urn:www.agenziaentrate.gov.it:specificheTecniche:sco:730
type	DatoCB_Type
facets	Kind Value pattern [01]

element **Documento_730-4/SoggettoAssFiscale730-4/DatiAgenzia730-4/Informazioni**

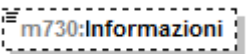
diagram	
namespace	urn:www.agenziaentrate.gov.it:specificheTecniche:sco:730
type	DatoAN_Type
facets	Kind Value pattern ([0-9A-Z- "}{1}{[0-9A-Z&:] ' - \., / ° °\(\) À É È Ì Ò Ù Ú " \N \+)*

element **Documento_730-4/AltriDati**

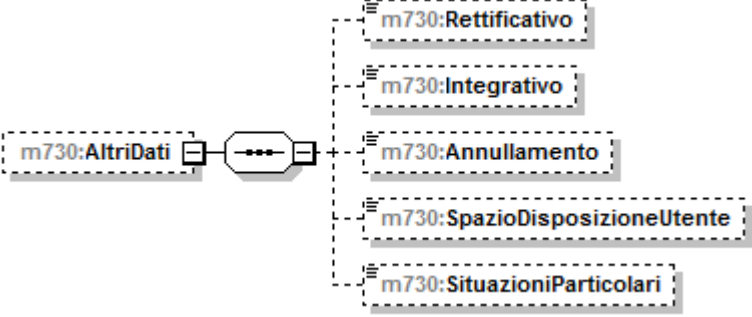
diagram	
namespace	urn:www.agenziaentrate.gov.it:specificheTecniche:sco:730
children	m730:Rettificativo m730:Integrativo m730:Annullamento m730:SpazioDisposizioneUtente m730:SituazioniParticolari

element **Documento_730-4/AltriDati/Rettificativo**

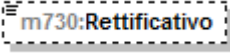
diagram											
namespace	urn:www.agenziaentrate.gov.it:specificheTecniche:sco:730										
type	m730:Rettificativo_Type										
facets	<table border="1"> <thead> <tr> <th>Kind</th> <th>Value</th> </tr> </thead> <tbody> <tr> <td>pattern</td> <td>[1-9]</td> </tr> <tr> <td>enumeration</td> <td>1</td> </tr> <tr> <td>enumeration</td> <td>2</td> </tr> <tr> <td>enumeration</td> <td>3</td> </tr> </tbody> </table>	Kind	Value	pattern	[1-9]	enumeration	1	enumeration	2	enumeration	3
Kind	Value										
pattern	[1-9]										
enumeration	1										
enumeration	2										
enumeration	3										

element **Documento_730-4/AltriDati/Integrativo**

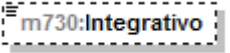
diagram											
namespace	urn:www.agenziaentrate.gov.it:specificheTecniche:sco:730										
type	m730:Integrativo_Type										
facets	<table border="1"> <thead> <tr> <th>Kind</th> <th>Value</th> </tr> </thead> <tbody> <tr> <td>pattern</td> <td>[1-9]</td> </tr> <tr> <td>enumeration</td> <td>1</td> </tr> <tr> <td>enumeration</td> <td>2</td> </tr> <tr> <td>enumeration</td> <td>3</td> </tr> </tbody> </table>	Kind	Value	pattern	[1-9]	enumeration	1	enumeration	2	enumeration	3
Kind	Value										
pattern	[1-9]										
enumeration	1										
enumeration	2										
enumeration	3										

element **Documento_730-4/AltriDati/Annullamento**

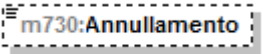
diagram					
namespace	urn:www.agenziaentrate.gov.it:specificheTecniche:sco:730				
type	DatoCB_Type				
facets	<table border="1"> <thead> <tr> <th>Kind</th> <th>Value</th> </tr> </thead> <tbody> <tr> <td>pattern</td> <td>[01]</td> </tr> </tbody> </table>	Kind	Value	pattern	[01]
Kind	Value				
pattern	[01]				

element **Documento_730-4/AltriDati/SpazioDisposizioneUtente**

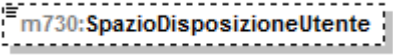
diagram					
namespace	urn:www.agenziaentrate.gov.it:specificheTecniche:sco:730				
type	DatoAN_Type				
facets	<table border="1"> <thead> <tr> <th>Kind</th> <th>Value</th> </tr> </thead> <tbody> <tr> <td>pattern</td> <td>(([0-9A-Z-] \&quot;){1}([0-9A-Z&amp;] " \- \., / "^\(\ \) À É È Ì Ò Ù Û &quot; \N \+)*</td> </tr> </tbody> </table>	Kind	Value	pattern	(([0-9A-Z-] \"){1}([0-9A-Z&] " \- \., / "^\(\ \) À É È Ì Ò Ù Û " \N \+)*
Kind	Value				
pattern	(([0-9A-Z-] \"){1}([0-9A-Z&] " \- \., / "^\(\ \) À É È Ì Ò Ù Û " \N \+)*				

element **Documento_730-4/AltriDati/SituazioniParticolari**

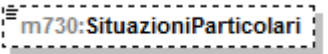
diagram	
namespace	urn:www.agenziaentrate.gov.it:specificheTecniche:sco:730
type	DatoNP_Type

facets	Kind pattern	Value [1-9]{1}[0-9]*
--------	-----------------	-------------------------

element **Documento_730-4/DatiContabili730-4**

diagram	
namespace	urn:www.agenziaentrate.gov.it:specificheTecniche:sco:730
children	m730:Ordinario_730-4 m730:Integrativo_730-4

element **Documento_730-4/DatiContabili730-4/Ordinario_730-4**

diagram	
namespace	urn:www.agenziaentrate.gov.it:specificheTecniche:sco:730
children	m730:ImportiTrattenere m730:ImportiRimborsare m730:Conguaglio

element Documento_730-4/DatiContabili730-4/Ordinario_730-4/ImportiTrattenere

<p>diagram</p>	
<p>namespace</p>	<p>urn:www.agenziaentrate.gov.it:specificheTecniche:sco:730</p>
<p>type</p>	<p>m730:Importi_Trattenere_730-4_Type</p>
<p>children</p>	<p>m730:IrpefTrattenere m730:AddRegTrattenere m730:AddComTrattenere m730:IrpefPrimaRataTrattenere m730:IrpefSecondaRataTrattenere m730:TassSepAccontoTrattenere m730:AddComAccontoTrattenere m730:PremiRisultatoTrattenere m730:CedolareTrattenere m730:CedolarePrimaRataTrattenere m730:CedolareSecondaRataTrattenere m730:ContribSolidTrattenere</p>

element Documento_730-4/DatiContabili730-4/Ordinario_730-4/ImportiRimborsare

<p>diagram</p>	
<p>namespace</p>	<p>urn:www.agenziaentrate.gov.it:specificheTecniche:sco:730</p>
<p>type</p>	<p>m730:Importi_Rimborsare_730-4_Type</p>

children	m730:IrpefRimborsare m730:AddRegRimborsare m730:AddComRimborsare m730:CedolareRimborsare
----------	--

element **Documento_730-4/DatiContabili730-4/Ordinario_730-4/Conguaglio**

diagram	
namespace	urn:www.agenziaentrate.gov.it:specificheTecniche:sco:730
children	m730:NumeroRate m730:ImportoRimborsare m730:ImportoTrattenere

element **Documento_730-4/DatiContabili730-4/Ordinario_730-4/Conguaglio/NumeroRate**

diagram					
namespace	urn:www.agenziaentrate.gov.it:specificheTecniche:sco:730				
type	DatoN1_Type				
facets	<table border="1"> <tr> <td>Kind</td> <td>Value</td> </tr> <tr> <td>pattern</td> <td>[1-9]</td> </tr> </table>	Kind	Value	pattern	[1-9]
Kind	Value				
pattern	[1-9]				

element **Documento_730-4/DatiContabili730-4/Ordinario_730-4/Conguaglio/ImportoRimborsare**

diagram					
namespace	urn:www.agenziaentrate.gov.it:specificheTecniche:sco:730				
type	DatoNP_Type				
facets	<table border="1"> <tr> <td>Kind</td> <td>Value</td> </tr> <tr> <td>pattern</td> <td>[1-9]{1}[0-9]*</td> </tr> </table>	Kind	Value	pattern	[1-9]{1}[0-9]*
Kind	Value				
pattern	[1-9]{1}[0-9]*				

element **Documento_730-4/DatiContabili730-4/Ordinario_730-4/Conguaglio/ImportoTrattenere**

diagram					
namespace	urn:www.agenziaentrate.gov.it:specificheTecniche:sco:730				
type	DatoNP_Type				
facets	<table border="1"> <tr> <td>Kind</td> <td>Value</td> </tr> <tr> <td>pattern</td> <td>[1-9]{1}[0-9]*</td> </tr> </table>	Kind	Value	pattern	[1-9]{1}[0-9]*
Kind	Value				
pattern	[1-9]{1}[0-9]*				

element **Documento_730-4/DatiContabili730-4/Integrativo_730-4**

diagram	
namespace	urn:www.agenziaentrate.gov.it:specificheTecniche:sco:730

children	m730:ImportiRimborsare
----------	--

element Documento_730-4/DatiContabili730-4/Integrativo_730-4/ImportiRimborsare

diagram	<pre> classDiagram class m730:ImportiRimborsare class m730:IrpefRimborsare class m730:AddRegRimborsare class m730:AddComRimborsare class m730:CedolareRimborsare class m730:TassazioneSepRimborsare class m730:PremiRisultatoRimborsare class m730:ContributoSolidarieta m730:ImportiRimborsare < -- m730:IrpefRimborsare m730:ImportiRimborsare < -- m730:AddRegRimborsare m730:ImportiRimborsare < -- m730:AddComRimborsare m730:ImportiRimborsare < -- m730:CedolareRimborsare m730:ImportiRimborsare < -- m730:TassazioneSepRimborsare m730:ImportiRimborsare < -- m730:PremiRisultatoRimborsare m730:ImportiRimborsare < -- m730:ContributoSolidarieta </pre>
namespace	urn:www.agenziaentrate.gov.it:specificheTecniche:sco:730
type	m730:Importi_Rimborsare_730-4_Integrativo_Type
children	m730:IrpefRimborsare m730:AddRegRimborsare m730:AddComRimborsare m730:CedolareRimborsare m730:TassazioneSepRimborsare m730:PremiRisultatoRimborsare m730:ContributoSolidarieta

complexType Documento_730_Type

diagram					
namespace	urn:www.agenziaentrate.gov.it:specificheTecniche:sco:730				
type	extension of Documento_Type				
children	m730:DichiarazioneDich m730:DichiarazioneCon m730:AltriDati m730:Sostituto m730:Mod730DipendentiSenzaSostituto m730:SoggettoAssFiscaleDoc m730:Documento_730-4 m730:EsitiContabili m730:DatiRettificati				
attributes	Name	Type	Use	Default	Fixed
	identificativo	Identificativo_Type	required		

element Documento_730_Type/DichiarazioneDich

diagram					
namespace	urn:www.agenziaentrate.gov.it:specificheTecniche:sco:730				
type	m730:Dichiarazione_Dich_Type				

children	m730:Frontespizio m730:DatiContabili m730:FuoriAssistenza m730:Scelte
----------	---

element **Documento_730_Type/DichiarazioneCon**

diagram	
namespace	urn:www.agenziaentrate.gov.it:specificheTecniche:sco:730
type	m730:Dichiarazione Con Type
children	m730:Frontespizio m730:DatiContabili m730:FuoriAssistenzaQuadri m730:Scelte

element **Documento_730_Type/AltriDati**

diagram	
namespace	urn:www.agenziaentrate.gov.it:specificheTecniche:sco:730
children	m730:FlagConferma m730:FlagAssenzaDati730-4 m730:FlagCfErratoDicTrasmessa m730:Rettificativo m730:Integrativo m730:CfProduttoreSoftware m730:SpazioDisposizioneUtente m730:DichiarazioneCongiunta m730:SituazioniParticolari m730:Mod730SenzaSostituto m730:ComunicazioneDatiRettificati m730:SostCafProfessNonDelega...

	m730:SostCafProfessNonDelegato
--	--

element **Documento_730_Type/AltriDati/FlagConferma**

diagram					
namespace	urn:www.agenziaentrate.gov.it:specificheTecniche:sco:730				
type	DatoCB_Type				
facets	<table border="1"> <tr> <td>Kind</td> <td>Value</td> </tr> <tr> <td>pattern</td> <td>[01]</td> </tr> </table>	Kind	Value	pattern	[01]
Kind	Value				
pattern	[01]				

element **Documento_730_Type/AltriDati/FlagAssenzaDati730-4**

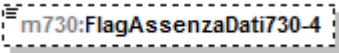
diagram					
namespace	urn:www.agenziaentrate.gov.it:specificheTecniche:sco:730				
type	DatoCB_Type				
facets	<table border="1"> <tr> <td>Kind</td> <td>Value</td> </tr> <tr> <td>pattern</td> <td>[01]</td> </tr> </table>	Kind	Value	pattern	[01]
Kind	Value				
pattern	[01]				

element **Documento_730_Type/AltriDati/FlagCfErratoDicTrasmessa**

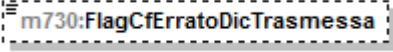
diagram					
namespace	urn:www.agenziaentrate.gov.it:specificheTecniche:sco:730				
type	DatoCF_Type				
facets	<table border="1"> <tr> <td>Kind</td> <td>Value</td> </tr> <tr> <td>pattern</td> <td>[0-9]{11}[A-Z]{6}[0-9LMNPQRSTU]{2}[A-Z]{1}[0-9LMNPQRSTU]{2}[A-Z]{1}[0-9LMNPQRSTU]{3}[A-Z]{1}</td> </tr> </table>	Kind	Value	pattern	[0-9]{11}[A-Z]{6}[0-9LMNPQRSTU]{2}[A-Z]{1}[0-9LMNPQRSTU]{2}[A-Z]{1}[0-9LMNPQRSTU]{3}[A-Z]{1}
Kind	Value				
pattern	[0-9]{11}[A-Z]{6}[0-9LMNPQRSTU]{2}[A-Z]{1}[0-9LMNPQRSTU]{2}[A-Z]{1}[0-9LMNPQRSTU]{3}[A-Z]{1}				

element **Documento_730_Type/AltriDati/Rettificativo**

diagram											
namespace	urn:www.agenziaentrate.gov.it:specificheTecniche:sco:730										
type	m730:Rettificativo_Type										
facets	<table border="1"> <tr> <td>Kind</td> <td>Value</td> </tr> <tr> <td>pattern</td> <td>[1-9]</td> </tr> <tr> <td>enumeration</td> <td>1</td> </tr> <tr> <td>enumeration</td> <td>2</td> </tr> <tr> <td>enumeration</td> <td>3</td> </tr> </table>	Kind	Value	pattern	[1-9]	enumeration	1	enumeration	2	enumeration	3
Kind	Value										
pattern	[1-9]										
enumeration	1										
enumeration	2										
enumeration	3										

element **Documento_730_Type/AltriDati/Integrativo**

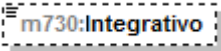
diagram	
namespace	urn:www.agenziaentrate.gov.it:specificheTecniche:sco:730

type	m730:Integrativo_Type	
facets	Kind	Value
	pattern	[1-9]
	enumeration	1
	enumeration	2
	enumeration	3

element Documento_730_Type/AltriDati/CfProduttoreSoftware

diagram	 m730:CfProduttoreSoftware	
namespace	urn:www.agenziaentrate.gov.it:specificheTecniche:sco:730	
type	DatoCF_Type	
facets	Kind	Value
	pattern	[0-9]{11}[A-Z]{6}[0-9LMNPQRSTUVWXYZ]{2}[A-Z]{1}[0-9LMNPQRSTUVWXYZ]{2}[A-Z]{1}[0-9LMNPQRSTUVWXYZ]{3}[A-Z]{1}

element Documento_730_Type/AltriDati/SpazioDisposizioneUtente

diagram	 m730:SpazioDisposizioneUtente	
namespace	urn:www.agenziaentrate.gov.it:specificheTecniche:sco:730	
type	DatoAN_Type	
facets	Kind	Value
	pattern	([0-9A-Z- "]{1} [0-9A-Z&#92; ! - . / ^\\(\\) À É È Ò Ù Û " \\ \\ +)*

element Documento_730_Type/AltriDati/DichiarazioneCongiunta

diagram	 m730:DichiarazioneCongiunta	
namespace	urn:www.agenziaentrate.gov.it:specificheTecniche:sco:730	
type	DatoCB_Type	
facets	Kind	Value
	pattern	[01]

element Documento_730_Type/AltriDati/SituazioniParticolari

diagram	 m730:SituazioniParticolari	
namespace	urn:www.agenziaentrate.gov.it:specificheTecniche:sco:730	
type	DatoNP_Type	
facets	Kind	Value
	pattern	[1-9]{1}[0-9]*

element Documento_730_Type/AltriDati/Mod730SenzaSostituto

diagram	 m730:Mod730SenzaSostituto	
---------	---	--

namespace	urn:www.agenziaentrate.gov.it:specificheTecniche:sco:730						
type	restriction of DatoAN_Type						
facets	<table border="0"> <tr> <td>Kind</td> <td>Value</td> </tr> <tr> <td>pattern</td> <td>(([0-9A-Z-])&quot;){1}([0-9A-Z&amp;:] ' -\. . /° °\ °\(\) À É È Ì Ò Ù Û &quot; \N \\+)*</td> </tr> <tr> <td>enumeration</td> <td>A</td> </tr> </table>	Kind	Value	pattern	(([0-9A-Z-])"){1}([0-9A-Z&:] ' -\. . /° °\ °\(\) À É È Ì Ò Ù Û " \N \\+)*	enumeration	A
Kind	Value						
pattern	(([0-9A-Z-])"){1}([0-9A-Z&:] ' -\. . /° °\ °\(\) À É È Ì Ò Ù Û " \N \\+)*						
enumeration	A						

element **Documento_730_Type/AltriDati/ComunicazioneDatiRettificati**

diagram					
namespace	urn:www.agenziaentrate.gov.it:specificheTecniche:sco:730				
type	DatoCB_Type				
facets	<table border="0"> <tr> <td>Kind</td> <td>Value</td> </tr> <tr> <td>pattern</td> <td>[01]</td> </tr> </table>	Kind	Value	pattern	[01]
Kind	Value				
pattern	[01]				

element **Documento_730_Type/AltriDati/SostCafProfessNonDelegato**

diagram					
namespace	urn:www.agenziaentrate.gov.it:specificheTecniche:sco:730				
type	DatoCB_Type				
facets	<table border="0"> <tr> <td>Kind</td> <td>Value</td> </tr> <tr> <td>pattern</td> <td>[01]</td> </tr> </table>	Kind	Value	pattern	[01]
Kind	Value				
pattern	[01]				

element **Documento_730_Type/Sostituto**

diagram	
namespace	urn:www.agenziaentrate.gov.it:specificheTecniche:sco:730
type	m730:Sostituto_Type
children	m730:CodiceFiscale m730:DatiAnagraficiPF m730:DenominazionePNF m730:Residenza m730:Fax m730:CodiceSede

element **Documento_730_Type/Mod730DipendentiSenzaSostituto**

diagram	
namespace	urn:www.agenziaentrate.gov.it:specificheTecniche:sco:730
type	DatoCB_Type
facets	Kind Value pattern [01]

element **Documento_730_Type/SoggettoAssFiscaleDoc**

diagram	
namespace	urn:www.agenziaentrate.gov.it:specificheTecniche:sco:730
type	m730:Soggetto_Assistenza_Fiscale_Doc_Type
children	m730:DataConsegna m730:TipologiaSoggettoAssFisc m730:SostitutoCF m730:DatiCafDoc m730:DatiProfessionistaDoc m730:DatiAssociazioneDoc m730:AgenziaEntrate

element **Documento_730_Type/Documento_730-4**

diagram	
namespace	urn:www.agenziaentrate.gov.it:specificheTecniche:sco:730

type	m730:Documento_730-4
children	m730:DatiAnagraficiDichiarante m730:Sostituto m730:SoggettoAssFiscale730-4 m730:AltriDati m730:DatiContabili730-4

element Documento_730_Type/EsitiContabili

diagram	
namespace	urn:www.agenziaentrate.gov.it:specificheTecniche:sco:730
children	m730:Conguaglio m730:Mod730Integrativo m730:VersamentiF24

element Documento_730_Type/EsitiContabili/Conguaglio

diagram	
namespace	urn:www.agenziaentrate.gov.it:specificheTecniche:sco:730
type	m730:Conguaglio_Type
children	m730:NumeroRate m730:ImportoTrattenutoSaldo m730:ImportoTrattenutoAcconto m730:ImportoDaVersareF24Saldo m730:ImportoDaVersareF24Acconto m730:ImportoRimborsato m730:ImportoRimborsatoAgenzia m730:OpzioneInformativa

element **Documento_730_Type/EsitiContabili/Mod730Integrativo**

<p>diagram</p>	
<p>namespace</p>	<p>urn:www.agenziaentrate.gov.it:specificheTecniche:sco:730</p>
<p>type</p>	<p>m730:Mod730_Integrativo_Type</p>
<p>children</p>	<p>m730:ImportiRimborsare m730:ImportoRimborsato m730:ImportoRimborsatoAgenzia</p>

element **Documento_730_Type/EsitiContabili/VersamentiF24**

<p>diagram</p>	
<p>namespace</p>	<p>urn:www.agenziaentrate.gov.it:specificheTecniche:sco:730</p>
<p>type</p>	<p>m730:Versamenti_F24_Type</p>
<p>children</p>	<p>m730:F24DebitoIrpef m730:F24DebitoCodRegione m730:F24DebitoAddReg m730:F24DebitoCodComune m730:F24DebitoAddCom m730:F24DebitoPrimaRataAcclIrpef m730:F24DebitoAccontoTassSep m730:F24DebitoCodComuneAcconto m730:F24DebitoAccontoAddCom m730:F24DebitoImpostaSost</p>

	m730:F24DebitoCedolare m730:F24DebitoPrimaRataAccCedolare m730:F24DebitoContribSolidarieta m730:F24DebitoCodRegioneConiuge m730:F24DebitoAddRegConiuge m730:F24DebitoCodComuneConiuge m730:F24DebitoAddComConiuge m730:F24DebitoCodComuneAccontoConiuge m730:F24DebitoAccontoAddComConiuge m730:F24DebitoSecondaRataAcclrpef m730:F24DebitoSecondaRataAccCedolare
--	---

element **Documento_730_Type/DatiRettificati**

diagram	
namespace	urn:www.agenziaentrate.gov.it:specificheTecniche:sco:730
type	m730:Dati_Rettificati_Type
children	m730:Rettifica

complexType **Domanda_Accatamento_Type**

diagram	
namespace	urn:www.agenziaentrate.gov.it:specificheTecniche:sco:730
children	m730:Data m730:Numero m730:ProvinciaUfficio

element **Domanda_Accatamento_Type/Data**

diagram					
namespace	urn:www.agenziaentrate.gov.it:specificheTecniche:sco:730				
type	DatoDT_Type				
facets	<table border="1"> <thead> <tr> <th>Kind</th> <th>Value</th> </tr> </thead> <tbody> <tr> <td>pattern</td> <td>(((0[1-9][12][0-9][301])(0[13578][1012](\d{4}))) ((0[1-9][12][0-9][30](0[469][11](\d{4}))) ((0[1-9][1[0-9]]2[0-8])(02)(\d{4}))) ((29)(02)([02468][048]00)) ((29)(02)([13579][26]00)) ((29)(02)([0-9][0-9][0][48])) ((29)(02)([0-9][0-9][2468][048])) ((29)(02)([0-9][0-9][13579][26]))))</td> </tr> </tbody> </table>	Kind	Value	pattern	(((0[1-9][12][0-9][301])(0[13578][1012](\d{4}))) ((0[1-9][12][0-9][30](0[469][11](\d{4}))) ((0[1-9][1[0-9]]2[0-8])(02)(\d{4}))) ((29)(02)([02468][048]00)) ((29)(02)([13579][26]00)) ((29)(02)([0-9][0-9][0][48])) ((29)(02)([0-9][0-9][2468][048])) ((29)(02)([0-9][0-9][13579][26]))))
Kind	Value				
pattern	(((0[1-9][12][0-9][301])(0[13578][1012](\d{4}))) ((0[1-9][12][0-9][30](0[469][11](\d{4}))) ((0[1-9][1[0-9]]2[0-8])(02)(\d{4}))) ((29)(02)([02468][048]00)) ((29)(02)([13579][26]00)) ((29)(02)([0-9][0-9][0][48])) ((29)(02)([0-9][0-9][2468][048])) ((29)(02)([0-9][0-9][13579][26]))))				

element **Domanda_Accatamento_Type/Numero**

diagram	
namespace	urn:www.agenziaentrate.gov.it:specificheTecniche:sco:730
type	DatoAN_Type

facets	Kind	Value
	pattern	([0-9A-Z-] \"){1}([0-9A-Z&#39; ! - \., / ^\\(\\) À É È Ì Ò Ù Ú " \\ \\ +)*

element **Domanda_Accatastamento_Type/ProvinciaUfficio**

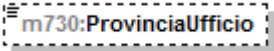
diagram	
namespace	urn:www.agenziaentrate.gov.it:specificheTecniche:sco:730
type	PN_Type

complexType **Domicilio_Fiscale_Acconto_Type**

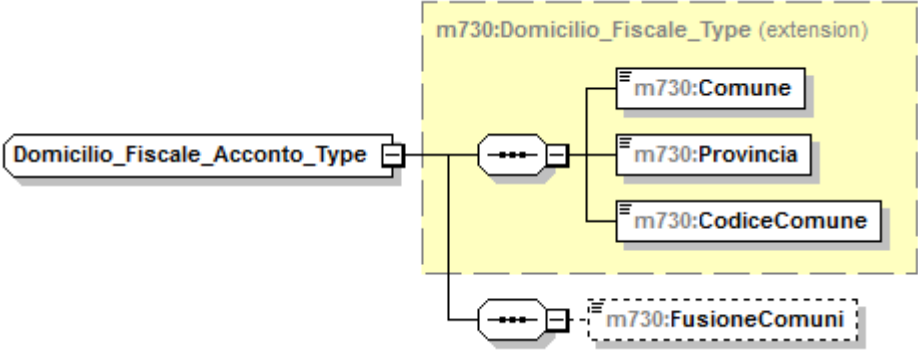
diagram	
namespace	urn:www.agenziaentrate.gov.it:specificheTecniche:sco:730
type	extension of m730:Domicilio_Fiscale_Type
children	m730:Comune m730:Provincia m730:CodiceComune m730:FusioneComuni

element **Domicilio_Fiscale_Acconto_Type/FusioneComuni**

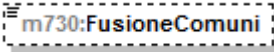
diagram		
namespace	urn:www.agenziaentrate.gov.it:specificheTecniche:sco:730	
type	DatoAN_Type	
facets	Kind	Value
	pattern	([0-9A-Z-] \"){1}([0-9A-Z&#39; ! - \., / ^\\(\\) À É È Ì Ò Ù Ú " \\ \\ +)*

complexType **Domicilio_Fiscale_Type**

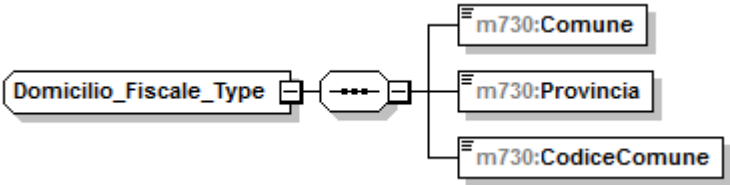
diagram	
namespace	urn:www.agenziaentrate.gov.it:specificheTecniche:sco:730

children	m730:Comune m730:Provincia m730:CodiceComune
----------	--

element **Domicilio_Fiscale_Type/Comune**

diagram	
namespace	urn:www.agenziaentrate.gov.it:specificheTecniche:sco:730
type	DatoAN Type
facets	Kind Value pattern ([0-9A-Z-] \"){1}([0-9A-Z&:] \- \., / ^ \^\(\\)\) À É È Ì Ò Ù Û " \\ / +)*

element **Domicilio_Fiscale_Type/Provincia**

diagram	
namespace	urn:www.agenziaentrate.gov.it:specificheTecniche:sco:730
type	PR Type

element **Domicilio_Fiscale_Type/CodiceComune**

diagram	
namespace	urn:www.agenziaentrate.gov.it:specificheTecniche:sco:730
type	DatoAN Type
facets	Kind Value pattern ([0-9A-Z-] \"){1}([0-9A-Z&:] \- \., / ^ \^\(\\)\) À É È Ì Ò Ù Û " \\ / +)*

complexType **Domicilio_Sogg_Ass_Fiscale_Type**

diagram	
namespace	urn:www.agenziaentrate.gov.it:specificheTecniche:sco:730

children	m730:Comune m730:Provincia m730:CodiceComune m730:Cap m730:Indirizzo m730:Telefono m730:FAX m730:Email
----------	--

element **Domicilio_Sogg_Ass_Fiscale_Type/Comune**

diagram	
namespace	urn:www.agenziaentrate.gov.it:specificheTecniche:sco:730
type	DatoAN_Type
facets	Kind Value pattern ([0-9A-Z\-\-]"){1}([0-9A-Z&:] ' - \., / ^ \^\(\ \)\ À É È Ì Ò Ù Û " \ \ \ +)*

element **Domicilio_Sogg_Ass_Fiscale_Type/Provincia**

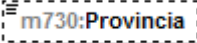
diagram	
namespace	urn:www.agenziaentrate.gov.it:specificheTecniche:sco:730
type	PR_Type

element **Domicilio_Sogg_Ass_Fiscale_Type/CodiceComune**

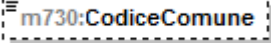
diagram	
namespace	urn:www.agenziaentrate.gov.it:specificheTecniche:sco:730
type	DatoAN_Type
facets	Kind Value pattern ([0-9A-Z\-\-]"){1}([0-9A-Z&:] ' - \., / ^ \^\(\ \)\ À É È Ì Ò Ù Û " \ \ \ +)*

element **Domicilio_Sogg_Ass_Fiscale_Type/Cap**

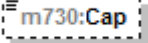
diagram	
namespace	urn:www.agenziaentrate.gov.it:specificheTecniche:sco:730
type	DatoAN_Type
facets	Kind Value pattern ([0-9A-Z\-\-]"){1}([0-9A-Z&:] ' - \., / ^ \^\(\ \)\ À É È Ì Ò Ù Û " \ \ \ +)*

element **Domicilio_Sogg_Ass_Fiscale_Type/Indirizzo**

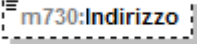
diagram	
namespace	urn:www.agenziaentrate.gov.it:specificheTecniche:sco:730
type	DatoAN_Type
facets	Kind Value pattern ([0-9A-Z\-\-]"){1}([0-9A-Z&:] ' - \., / ^ \^\(\ \)\ À É È Ì Ò Ù Û " \ \ \ +)*

element **Domicilio_Sogg_Ass_Fiscale_Type/Telefono**

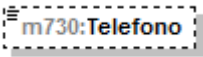
diagram	
namespace	urn:www.agenziaentrate.gov.it:specificheTecniche:sco:730
type	DatoAN_Type
facets	Kind Value pattern ([0-9A-Z-]*)"}{1}([0-9A-Z&#39;] \- \., / ^\\(\\) À É È Ì Ò Ù Û " \\ \\ \\ +)*

element **Domicilio_Sogg_Ass_Fiscale_Type/FAX**

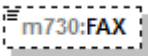
diagram	
namespace	urn:www.agenziaentrate.gov.it:specificheTecniche:sco:730
type	DatoAN_Type
facets	Kind Value pattern ([0-9A-Z-]*)"}{1}([0-9A-Z&#39;] \- \., / ^\\(\\) À É È Ì Ò Ù Û " \\ \\ \\ +)*

element **Domicilio_Sogg_Ass_Fiscale_Type/Email**

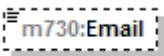
diagram	
namespace	urn:www.agenziaentrate.gov.it:specificheTecniche:sco:730
type	DatoEM_Type
facets	Kind Value pattern [a-zA-Z0-9_%.\\-\\"?^~=]+@[a-zA-Z0-9.\\-\\.[a-zA-Z]{2,4}

complexType Eccedenze_Oltre_Anno_Type

diagram	
namespace	urn:www.agenziaentrate.gov.it:specificheTecniche:sco:730
children	m730:Anno m730:Irpef m730:SostitutivaQuadroRT m730:CedolareSecca m730:CodiceRegione m730:AddRegionaleIrpef m730:CodiceCatastaleComune m730:AddComunaleIrpef m730:ImpostaSostitutiva

element Eccedenze_Oltre_Anno_Type/Anno

diagram					
namespace	urn:www.agenziaentrate.gov.it:specificheTecniche:sco:730				
type	DatoDA Type				
facets	<table border="1"> <thead> <tr> <th>Kind</th> <th>Value</th> </tr> </thead> <tbody> <tr> <td>pattern</td> <td>(18 19 20)[0-9]{2}</td> </tr> </tbody> </table>	Kind	Value	pattern	(18 19 20)[0-9]{2}
Kind	Value				
pattern	(18 19 20)[0-9]{2}				

element Eccedenze_Oltre_Anno_Type/Irpef

diagram					
namespace	urn:www.agenziaentrate.gov.it:specificheTecniche:sco:730				
type	DatoNP Type				
facets	<table border="1"> <thead> <tr> <th>Kind</th> <th>Value</th> </tr> </thead> <tbody> <tr> <td>pattern</td> <td>[1-9]{1}[0-9]*</td> </tr> </tbody> </table>	Kind	Value	pattern	[1-9]{1}[0-9]*
Kind	Value				
pattern	[1-9]{1}[0-9]*				

element Eccedenze_Oltre_Anno_Type/SostitutivaQuadroRT

diagram	
namespace	urn:www.agenziaentrate.gov.it:specificheTecniche:sco:730

type	DatoNP_Type
facets	Kind Value pattern [1-9]{1}[0-9]*

element **Eccedenze_Oltre_Anno_Type/CedolareSecca**

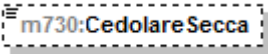
diagram	
namespace	urn:www.agenziaentrate.gov.it:specificheTecniche:sco:730
type	DatoNP_Type
facets	Kind Value pattern [1-9]{1}[0-9]*

element **Eccedenze_Oltre_Anno_Type/CodiceRegione**

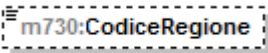
diagram	
namespace	urn:www.agenziaentrate.gov.it:specificheTecniche:sco:730
type	Codice_Regione_Type
facets	Kind Value pattern ([0-9A-Z\-\]"){1}([0-9A-Z&] \- \., / \° \^ \(\) À È É Ì Ò Ù Ü "; \\ \+)* enumeration 1 enumeration 2 enumeration 3 enumeration 4 enumeration 5 enumeration 6 enumeration 7 enumeration 8 enumeration 9 enumeration 10 enumeration 11 enumeration 12 enumeration 13 enumeration 14 enumeration 15 enumeration 16 enumeration 17 enumeration 18 enumeration 19 enumeration 20 enumeration 21

element **Eccedenze_Oltre_Anno_Type/AddRegionalelrpef**

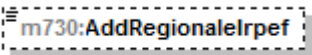
diagram	
namespace	urn:www.agenziaentrate.gov.it:specificheTecniche:sco:730
type	DatoNP_Type
facets	Kind Value pattern [1-9]{1}[0-9]*

element **Eccedenze_Oltre_Anno_Type/CodiceCatastaleComune**

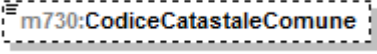
diagram					
namespace	urn:www.agenziaentrate.gov.it:specificheTecniche:sco:730				
type	restriction of DatoAN_Type				
facets	<table border="1"> <tr> <td>Kind</td> <td>Value</td> </tr> <tr> <td>pattern</td> <td>(([0-9A-Z-]&quot;){1}([0-9A-Z&amp;:] \" \. . ° ^\ (\) À É È Ì Ò Ù Ü &quot; \\ / +)*</td> </tr> </table>	Kind	Value	pattern	(([0-9A-Z-]"){1}([0-9A-Z&:] \" \. . ° ^\ (\) À É È Ì Ò Ù Ü " \\ / +)*
Kind	Value				
pattern	(([0-9A-Z-]"){1}([0-9A-Z&:] \" \. . ° ^\ (\) À É È Ì Ò Ù Ü " \\ / +)*				

element **Eccedenze_Oltre_Anno_Type/AddComunalelrpef**

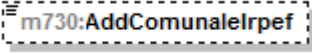
diagram					
namespace	urn:www.agenziaentrate.gov.it:specificheTecniche:sco:730				
type	DatoNP_Type				
facets	<table border="1"> <tr> <td>Kind</td> <td>Value</td> </tr> <tr> <td>pattern</td> <td>[1-9]{1}[0-9]*</td> </tr> </table>	Kind	Value	pattern	[1-9]{1}[0-9]*
Kind	Value				
pattern	[1-9]{1}[0-9]*				

element **Eccedenze_Oltre_Anno_Type/ImpostaSostitutiva**

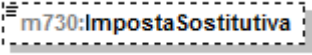
diagram					
namespace	urn:www.agenziaentrate.gov.it:specificheTecniche:sco:730				
type	DatoNP_Type				
facets	<table border="1"> <tr> <td>Kind</td> <td>Value</td> </tr> <tr> <td>pattern</td> <td>[1-9]{1}[0-9]*</td> </tr> </table>	Kind	Value	pattern	[1-9]{1}[0-9]*
Kind	Value				
pattern	[1-9]{1}[0-9]*				

complexType **Eccedenze_Type**

diagram	
namespace	urn:www.agenziaentrate.gov.it:specificheTecniche:sco:730
children	m730:Irpef m730:IrpefCompF24 m730:SostitutivaQuadroRT m730:SostitutivaQuadroRTcompF24 m730:CedolareSecca m730:CedolareSeccaCompF24 m730:CodiceRegione m730:AddRegionaleIrpef m730:AddRegionaleIrpefCompF24 m730:CodiceCatastaleComune m730:AddComunaleIrpef m730:AddComunaleIrpefF24

element **Eccedenze_Type/Irpef**

diagram					
namespace	urn:www.agenziaentrate.gov.it:specificheTecniche:sco:730				
type	DatoNP_Type				
facets	<table border="1"> <thead> <tr> <th>Kind</th> <th>Value</th> </tr> </thead> <tbody> <tr> <td>pattern</td> <td>[1-9]{1}[0-9]*</td> </tr> </tbody> </table>	Kind	Value	pattern	[1-9]{1}[0-9]*
Kind	Value				
pattern	[1-9]{1}[0-9]*				

element **Eccedenze_Type/IrpefCompF24**

diagram					
namespace	urn:www.agenziaentrate.gov.it:specificheTecniche:sco:730				
type	DatoNP_Type				
facets	<table border="1"> <thead> <tr> <th>Kind</th> <th>Value</th> </tr> </thead> <tbody> <tr> <td>pattern</td> <td>[1-9]{1}[0-9]*</td> </tr> </tbody> </table>	Kind	Value	pattern	[1-9]{1}[0-9]*
Kind	Value				
pattern	[1-9]{1}[0-9]*				

element **Eccedenze_Type/SostitutivaQuadroRT**

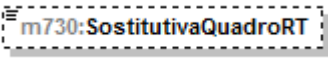
diagram	
namespace	urn:www.agenziaentrate.gov.it:specificheTecniche:sco:730
type	DatoNP_Type
facets	Kind Value pattern [1-9]{1}[0-9]*

element **Eccedenze_Type/SostitutivaQuadroRTcompF24**

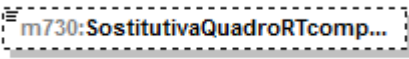
diagram	
namespace	urn:www.agenziaentrate.gov.it:specificheTecniche:sco:730
type	DatoNP_Type
facets	Kind Value pattern [1-9]{1}[0-9]*

element **Eccedenze_Type/CedolareSecca**

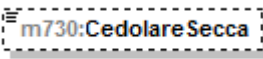
diagram	
namespace	urn:www.agenziaentrate.gov.it:specificheTecniche:sco:730
type	DatoNP_Type
facets	Kind Value pattern [1-9]{1}[0-9]*

element **Eccedenze_Type/CedolareSeccaCompF24**

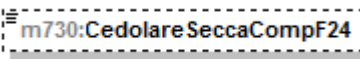
diagram	
namespace	urn:www.agenziaentrate.gov.it:specificheTecniche:sco:730
type	DatoNP_Type
facets	Kind Value pattern [1-9]{1}[0-9]*

element **Eccedenze_Type/CodiceRegione**

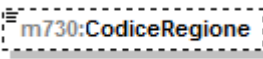
diagram	
namespace	urn:www.agenziaentrate.gov.it:specificheTecniche:sco:730
type	Codice Regione Type
facets	Kind Value pattern (([0-9A-Z\-_]"){1}([0-9A-Z&:] \- \., / ^ \^\(\\) À È É Ì Ò Ù Û " \\N \\+)* enumeration 1

enumeration	2
enumeration	3
enumeration	4
enumeration	5
enumeration	6
enumeration	7
enumeration	8
enumeration	9
enumeration	10
enumeration	11
enumeration	12
enumeration	13
enumeration	14
enumeration	15
enumeration	16
enumeration	17
enumeration	18
enumeration	19
enumeration	20
enumeration	21

element Eccedenze_Type/AddRegionalelrpef

diagram					
namespace	urn:www.agenziaentrate.gov.it:specificheTecniche:sco:730				
type	DatoNP_Type				
facets	<table border="1"> <tr><td>Kind</td><td>Value</td></tr> <tr><td>pattern</td><td>[1-9]{1}[0-9]*</td></tr> </table>	Kind	Value	pattern	[1-9]{1}[0-9]*
Kind	Value				
pattern	[1-9]{1}[0-9]*				

element Eccedenze_Type/AddRegionalelrpefCompF24

diagram					
namespace	urn:www.agenziaentrate.gov.it:specificheTecniche:sco:730				
type	DatoNP_Type				
facets	<table border="1"> <tr><td>Kind</td><td>Value</td></tr> <tr><td>pattern</td><td>[1-9]{1}[0-9]*</td></tr> </table>	Kind	Value	pattern	[1-9]{1}[0-9]*
Kind	Value				
pattern	[1-9]{1}[0-9]*				

element Eccedenze_Type/CodiceCatastaleComune

diagram					
namespace	urn:www.agenziaentrate.gov.it:specificheTecniche:sco:730				
type	restriction of DatoAN_Type				
facets	<table border="1"> <tr><td>Kind</td><td>Value</td></tr> <tr><td>pattern</td><td>(([0-9A-Z-] \&quot;){1}([0-9A-Z&amp;:] \- \., / \^\(\ \)\ À È É Ì Ò Ù Û &quot; \N \+)*</td></tr> </table>	Kind	Value	pattern	(([0-9A-Z-] \"){1}([0-9A-Z&:] \- \., / \^\(\ \)\ À È É Ì Ò Ù Û " \N \+)*
Kind	Value				
pattern	(([0-9A-Z-] \"){1}([0-9A-Z&:] \- \., / \^\(\ \)\ À È É Ì Ò Ù Û " \N \+)*				

element Eccedenze_Type/AddComunalelrpef

diagram	
---------	--

namespace	urn:www.agenziaentrate.gov.it:specificheTecniche:sco:730
type	DatoNP_Type
facets	Kind Value pattern [1-9]{1}[0-9]*

element **Eccedenze_Type/AddComunaleIrpefF24**

diagram	
namespace	urn:www.agenziaentrate.gov.it:specificheTecniche:sco:730
type	DatoNP_Type
facets	Kind Value pattern [1-9]{1}[0-9]*

complexType **Elemento_Integrativo_Type**

diagram	
namespace	urn:www.agenziaentrate.gov.it:specificheTecniche:sco:730
children	m730:Irpef m730:AddizionaleRegionaleIrpef m730:AddComunaleIrpef m730:CedolareSecca

element **Elemento_Integrativo_Type/Irpef**

diagram	
namespace	urn:www.agenziaentrate.gov.it:specificheTecniche:sco:730
type	DatoNP_Type
facets	Kind Value pattern [1-9]{1}[0-9]*

element **Elemento_Integrativo_Type/AddizionaleRegionaleIrpef**

diagram	
namespace	urn:www.agenziaentrate.gov.it:specificheTecniche:sco:730
type	DatoNP_Type
facets	Kind Value pattern [1-9]{1}[0-9]*

element **Elemento_Integrativo_Type/AddComunalelrpef**

diagram	
namespace	urn:www.agenziaentrate.gov.it:specificheTecniche:sco:730
type	DatoNP_Type
facets	Kind Value pattern [1-9]{1}[0-9]*

element **Elemento_Integrativo_Type/CedolareSecca**

diagram	
namespace	urn:www.agenziaentrate.gov.it:specificheTecniche:sco:730
type	DatoNP_Type
facets	Kind Value pattern [1-9]{1}[0-9]*

complexType **Esenzione_Add_Comunale_Type**

diagram	
namespace	urn:www.agenziaentrate.gov.it:specificheTecniche:sco:730
children	m730:SogliaEsenzioneSaldo m730:SogliaEsenzioneAcconto

element **Esenzione_Add_Comunale_Type/SogliaEsenzioneSaldo**

diagram	
namespace	urn:www.agenziaentrate.gov.it:specificheTecniche:sco:730
type	m730:Soglie_Esenzione_Type
children	m730:SogliaEsenzione m730:EsenzioneTotale

element **Esenzione_Add_Comunale_Type/SogliaEsenzioneAcconto**

diagram	
namespace	urn:www.agenziaentrate.gov.it:specificheTecniche:sco:730
type	m730:Soglie_Esenzione_Type
children	m730:SogliaEsenzione m730:EsenzioneTotale

complexType **Esenzione_Bonus_Type**

diagram	
namespace	urn:www.agenziaentrate.gov.it:specificheTecniche:sco:730
children	m730:TipologiaEsenzione m730:ParteRedditoEsente

element **Esenzione_Bonus_Type/TipologiaEsenzione**

diagram									
namespace	urn:www.agenziaentrate.gov.it:specificheTecniche:sco:730								
type	restriction of DatoN1_Type								
facets	<table border="1"> <thead> <tr> <th>Kind</th> <th>Value</th> </tr> </thead> <tbody> <tr> <td>pattern</td> <td>[1-9]</td> </tr> <tr> <td>enumeration</td> <td>1</td> </tr> <tr> <td>enumeration</td> <td>2</td> </tr> </tbody> </table>	Kind	Value	pattern	[1-9]	enumeration	1	enumeration	2
Kind	Value								
pattern	[1-9]								
enumeration	1								
enumeration	2								

element **Esenzione_Bonus_Type/ParteRedditoEsente**

diagram					
namespace	urn:www.agenziaentrate.gov.it:specificheTecniche:sco:730				
type	DatoNP_Type				
facets	<table border="1"> <thead> <tr> <th>Kind</th> <th>Value</th> </tr> </thead> <tbody> <tr> <td>pattern</td> <td>[1-9]{1}[0-9]*</td> </tr> </tbody> </table>	Kind	Value	pattern	[1-9]{1}[0-9]*
Kind	Value				
pattern	[1-9]{1}[0-9]*				

complexType **Esito_Liquidazione_Type**

diagram	
namespace	urn:www.agenziaentrate.gov.it:specificheTecniche:sco:730
children	m730:Credito m730:Debito

element **Esito_Liquidazione_Type/Credito**

diagram	
namespace	urn:www.agenziaentrate.gov.it:specificheTecniche:sco:730
type	m730:Credito_Type
children	m730:NonRimborsabile m730:Credito m730:CreditoF24 m730:CreditoRimborso

element **Esito_Liquidazione_Type/Debito**

diagram	
namespace	urn:www.agenziaentrate.gov.it:specificheTecniche:sco:730
type	m730:Debito_Type
children	m730:NonVersare m730:ImportoDaTrattenere

complexType **Fabbricato_Agev_Type**

diagram	
namespace	urn:www.agenziaentrate.gov.it:specificheTecniche:sco:730
children	m730:NumeroRigoRiferimento m730:NumModuloRiferimento m730:DatiContratto m730:CasellaInf30Giorni m730:AnnoDichiarazioneIcilmu m730:StatoEmergenza

element **Fabbricato_Agev_Type/NumeroRigoRiferimento**

diagram																									
namespace	urn:www.agenziaentrate.gov.it:specificheTecniche:sco:730																								
type	m730:Fabbricato_Agev_Numero_Rigo_Type																								
facets	<table border="1"> <thead> <tr> <th>Kind</th> <th>Value</th> </tr> </thead> <tbody> <tr> <td>pattern</td> <td>[1-9]{1}[0-9]*</td> </tr> <tr> <td>enumeration</td> <td>1</td> </tr> <tr> <td>enumeration</td> <td>2</td> </tr> <tr> <td>enumeration</td> <td>3</td> </tr> <tr> <td>enumeration</td> <td>4</td> </tr> <tr> <td>enumeration</td> <td>5</td> </tr> <tr> <td>enumeration</td> <td>6</td> </tr> <tr> <td>enumeration</td> <td>7</td> </tr> <tr> <td>enumeration</td> <td>8</td> </tr> <tr> <td>enumeration</td> <td>9</td> </tr> <tr> <td>enumeration</td> <td>10</td> </tr> </tbody> </table>	Kind	Value	pattern	[1-9]{1}[0-9]*	enumeration	1	enumeration	2	enumeration	3	enumeration	4	enumeration	5	enumeration	6	enumeration	7	enumeration	8	enumeration	9	enumeration	10
Kind	Value																								
pattern	[1-9]{1}[0-9]*																								
enumeration	1																								
enumeration	2																								
enumeration	3																								
enumeration	4																								
enumeration	5																								
enumeration	6																								
enumeration	7																								
enumeration	8																								
enumeration	9																								
enumeration	10																								

element **Fabbricato_Agev_Type/NumModuloRiferimento**

diagram					
namespace	urn:www.agenziaentrate.gov.it:specificheTecniche:sco:730				
type	DatoNP_Type				
facets	<table border="1"> <thead> <tr> <th>Kind</th> <th>Value</th> </tr> </thead> <tbody> <tr> <td>pattern</td> <td>[1-9]{1}[0-9]*</td> </tr> </tbody> </table>	Kind	Value	pattern	[1-9]{1}[0-9]*
Kind	Value				
pattern	[1-9]{1}[0-9]*				

element **Fabbricato_Agev_Type/DatiContratto**

diagram	
namespace	urn:www.agenziaentrate.gov.it:specificheTecniche:sco:730
type	m730:Dati_Contratto_Type
children	m730:DataRegContratto m730:SerieContratto m730:NumeroContratto m730:Sottonumero m730:CodiceUfficio m730:IdentificativoContratto

element **Fabbricato_Agev_Type/CasellaInf30Giorni**

diagram					
namespace	urn:www.agenziaentrate.gov.it:specificheTecniche:sco:730				
type	DatoCB_Type				
facets	<table border="1"> <thead> <tr> <th>Kind</th> <th>Value</th> </tr> </thead> <tbody> <tr> <td>pattern</td> <td>[01]</td> </tr> </tbody> </table>	Kind	Value	pattern	[01]
Kind	Value				
pattern	[01]				

element **Fabbricato_Agev_Type/AnnoDichiarazioneIcilmu**

diagram					
namespace	urn:www.agenziaentrate.gov.it:specificheTecniche:sco:730				
type	DatoDA_Type				
facets	<table border="1"> <thead> <tr> <th>Kind</th> <th>Value</th> </tr> </thead> <tbody> <tr> <td>pattern</td> <td>(18 19 20)[0-9]{2}</td> </tr> </tbody> </table>	Kind	Value	pattern	(18 19 20)[0-9]{2}
Kind	Value				
pattern	(18 19 20)[0-9]{2}				

element **Fabbricato_Agev_Type/StatoEmergenza**

diagram					
namespace	urn:www.agenziaentrate.gov.it:specificheTecniche:sco:730				
type	DatoCB_Type				
facets	<table border="1"> <thead> <tr> <th>Kind</th> <th>Value</th> </tr> </thead> <tbody> <tr> <td>pattern</td> <td>[01]</td> </tr> </tbody> </table>	Kind	Value	pattern	[01]
Kind	Value				
pattern	[01]				

complexType **Fabbricato_Ord_Type**

diagram	
namespace	urn:www.agenziaentrate.gov.it:specificheTecniche:sco:730
children	m730:Rendita m730:Utilizzo m730:GiorniPossesso m730:PercPossesso m730:CodiceCanone m730:CanoneLocazione m730:CasiParticolari m730:CasellaContinuazione m730:CodiceComune m730:OpzioneCedolare m730:CasellaCasiPartimu

element **Fabbricato_Ord_Type/Rendita**

diagram					
namespace	urn:www.agenziaentrate.gov.it:specificheTecniche:sco:730				
type	DatoNP_Type				
facets	<table border="1"> <thead> <tr> <th>Kind</th> <th>Value</th> </tr> </thead> <tbody> <tr> <td>pattern</td> <td>[1-9]{1}[0-9]*</td> </tr> </tbody> </table>	Kind	Value	pattern	[1-9]{1}[0-9]*
Kind	Value				
pattern	[1-9]{1}[0-9]*				

element **Fabbricato_Ord_Type/Utilizzo**

diagram									
namespace	urn:www.agenziaentrate.gov.it:specificheTecniche:sco:730								
type	restriction of m730:Utilizzo Fabbricato_Type								
facets	<table border="1"> <thead> <tr> <th>Kind</th> <th>Value</th> </tr> </thead> <tbody> <tr> <td>pattern</td> <td>[1-9]{1}[0-9]*</td> </tr> <tr> <td>enumeration</td> <td>1</td> </tr> <tr> <td>enumeration</td> <td>2</td> </tr> </tbody> </table>	Kind	Value	pattern	[1-9]{1}[0-9]*	enumeration	1	enumeration	2
Kind	Value								
pattern	[1-9]{1}[0-9]*								
enumeration	1								
enumeration	2								

enumeration	3
enumeration	4
enumeration	5
enumeration	8
enumeration	9
enumeration	10
enumeration	11
enumeration	12
enumeration	14
enumeration	15
enumeration	16
enumeration	17

element **Fabbricato_Ord_Type/GiorniPossesso**

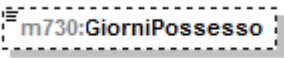
diagram					
namespace	urn:www.agenziaentrate.gov.it:specificheTecniche:sco:730				
type	restriction of DatoNP_Type				
facets	<table border="1"> <thead> <tr> <th>Kind</th> <th>Value</th> </tr> </thead> <tbody> <tr> <td>pattern</td> <td>[1-9]{1}[0-9]*</td> </tr> </tbody> </table>	Kind	Value	pattern	[1-9]{1}[0-9]*
Kind	Value				
pattern	[1-9]{1}[0-9]*				

element **Fabbricato_Ord_Type/PercPossesso**

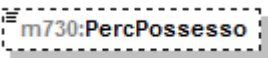
diagram					
namespace	urn:www.agenziaentrate.gov.it:specificheTecniche:sco:730				
type	DatoPC_Type				
facets	<table border="1"> <thead> <tr> <th>Kind</th> <th>Value</th> </tr> </thead> <tbody> <tr> <td>pattern</td> <td>[0-9]?[0-9](,\d{1,3})? 100,0{1,3}?</td> </tr> </tbody> </table>	Kind	Value	pattern	[0-9]?[0-9](,\d{1,3})? 100,0{1,3}?
Kind	Value				
pattern	[0-9]?[0-9](,\d{1,3})? 100,0{1,3}?				

element **Fabbricato_Ord_Type/CodiceCanone**

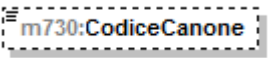
diagram													
namespace	urn:www.agenziaentrate.gov.it:specificheTecniche:sco:730												
type	m730:Codice Canone_Type												
facets	<table border="1"> <thead> <tr> <th>Kind</th> <th>Value</th> </tr> </thead> <tbody> <tr> <td>pattern</td> <td>[1-9]</td> </tr> <tr> <td>enumeration</td> <td>1</td> </tr> <tr> <td>enumeration</td> <td>2</td> </tr> <tr> <td>enumeration</td> <td>3</td> </tr> <tr> <td>enumeration</td> <td>4</td> </tr> </tbody> </table>	Kind	Value	pattern	[1-9]	enumeration	1	enumeration	2	enumeration	3	enumeration	4
Kind	Value												
pattern	[1-9]												
enumeration	1												
enumeration	2												
enumeration	3												
enumeration	4												

element **Fabbricato_Ord_Type/CanoneLocazione**

diagram	
namespace	urn:www.agenziaentrate.gov.it:specificheTecniche:sco:730
type	DatoNP_Type

facets	Kind	Value
	pattern	[1-9]{1}[0-9]*

element **Fabbricato_Ord_Type/CasiParticolari**

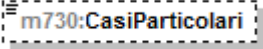
diagram													
namespace	urn:www.agenziaentrate.gov.it:specificheTecniche:sco:730												
type	m730:Casi Particolari Fabbricato Type												
facets	<table border="1"> <tr> <td>Kind</td> <td>Value</td> </tr> <tr> <td>pattern</td> <td>[1-9]</td> </tr> <tr> <td>enumeration</td> <td>1</td> </tr> <tr> <td>enumeration</td> <td>3</td> </tr> <tr> <td>enumeration</td> <td>4</td> </tr> <tr> <td>enumeration</td> <td>5</td> </tr> </table>	Kind	Value	pattern	[1-9]	enumeration	1	enumeration	3	enumeration	4	enumeration	5
Kind	Value												
pattern	[1-9]												
enumeration	1												
enumeration	3												
enumeration	4												
enumeration	5												

element **Fabbricato_Ord_Type/CasellaContinuazione**

diagram					
namespace	urn:www.agenziaentrate.gov.it:specificheTecniche:sco:730				
type	DatoCB Type				
facets	<table border="1"> <tr> <td>Kind</td> <td>Value</td> </tr> <tr> <td>pattern</td> <td>[01]</td> </tr> </table>	Kind	Value	pattern	[01]
Kind	Value				
pattern	[01]				

element **Fabbricato_Ord_Type/CodiceComune**

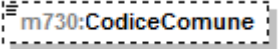
diagram					
namespace	urn:www.agenziaentrate.gov.it:specificheTecniche:sco:730				
type	restriction of DatoAN Type				
facets	<table border="1"> <tr> <td>Kind</td> <td>Value</td> </tr> <tr> <td>pattern</td> <td>([0-9A-Z-] \&quot;){1}([0-9A-Z&amp;] '\- \., / \^\(\ \)\À È É Ì Ò Ù Û \&quot; \ \ \ /+)*</td> </tr> </table>	Kind	Value	pattern	([0-9A-Z-] \"){1}([0-9A-Z&] '\- \., / \^\(\ \)\À È É Ì Ò Ù Û \" \ \ \ /+)*
Kind	Value				
pattern	([0-9A-Z-] \"){1}([0-9A-Z&] '\- \., / \^\(\ \)\À È É Ì Ò Ù Û \" \ \ \ /+)*				

element **Fabbricato_Ord_Type/OpzioneCedolare**

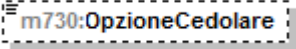
diagram					
namespace	urn:www.agenziaentrate.gov.it:specificheTecniche:sco:730				
type	DatoCB Type				
facets	<table border="1"> <tr> <td>Kind</td> <td>Value</td> </tr> <tr> <td>pattern</td> <td>[01]</td> </tr> </table>	Kind	Value	pattern	[01]
Kind	Value				
pattern	[01]				

element **Fabbricato_Ord_Type/CasellaCasiPartImu**

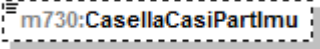
diagram	
---------	---

namespace	urn:www.agenziaentrate.gov.it:specificheTecniche:sco:730										
type	restriction of DatoN1_Type										
facets	<table border="0"> <tr> <td>Kind</td> <td>Value</td> </tr> <tr> <td>pattern</td> <td>[1-9]</td> </tr> <tr> <td>enumeration</td> <td>1</td> </tr> <tr> <td>enumeration</td> <td>2</td> </tr> <tr> <td>enumeration</td> <td>3</td> </tr> </table>	Kind	Value	pattern	[1-9]	enumeration	1	enumeration	2	enumeration	3
Kind	Value										
pattern	[1-9]										
enumeration	1										
enumeration	2										
enumeration	3										

complexType Familiari_Type

diagram	
namespace	urn:www.agenziaentrate.gov.it:specificheTecniche:sco:730
children	m730:PrimoModulo m730:Modulo

element Familiari_Type/PrimoModulo

diagram	
namespace	urn:www.agenziaentrate.gov.it:specificheTecniche:sco:730
type	m730:Primo_Modulo_Familiari_Type
children	m730:Coniuge m730:PrimoFiglio m730:Familiari m730:PercUlteriore m730:FigliAffidoPread

element **Familiari_Type/Modulo**

diagram	
namespace	urn:www.agenziaentrate.gov.it:specificheTecniche:sco:730
type	m730:Modulo_Familiari_Type
children	m730:Coniuge m730:PrimoFiglio m730:Familiari

complexType **Firma_Dichiarazione_Type**

diagram	
namespace	urn:www.agenziaentrate.gov.it:specificheTecniche:sco:730
children	m730:NumeroModelli m730:FirmaDichiarazione m730:OpzioneInformativa m730:SoggettoFiscalmenteCarico m730:QuadroK

element **Firma_Dichiarazione_Type/NumeroModelli**

diagram					
namespace	urn:www.agenziaentrate.gov.it:specificheTecniche:sco:730				
type	DatoNP_Type				
facets	<table border="1"> <thead> <tr> <th>Kind</th> <th>Value</th> </tr> </thead> <tbody> <tr> <td>pattern</td> <td>[1-9]{1}[0-9]*</td> </tr> </tbody> </table>	Kind	Value	pattern	[1-9]{1}[0-9]*
Kind	Value				
pattern	[1-9]{1}[0-9]*				

element **Firma_Dichiarazione_Type/FirmaDichiarazione**

diagram	
namespace	urn:www.agenziaentrate.gov.it:specificheTecniche:sco:730
type	DatoCB_Type

facets	Kind pattern	Value [01]
--------	-----------------	---------------

element **Firma Dichiarazione_Type/OpzioneInformativa**

diagram		
namespace	urn:www.agenziaentrate.gov.it:specificheTecniche:sco:730	
type	DatoCB_Type	
facets	Kind pattern	Value [01]

element **Firma Dichiarazione_Type/SoggettoFiscalmenteCarico**

diagram		
namespace	urn:www.agenziaentrate.gov.it:specificheTecniche:sco:730	
type	DatoCB_Type	
facets	Kind pattern	Value [01]

element **Firma Dichiarazione_Type/QuadroK**

diagram		
namespace	urn:www.agenziaentrate.gov.it:specificheTecniche:sco:730	
type	DatoCB_Type	
facets	Kind pattern	Value [01]

complexType **Fondo_Pensione_Dipendenti_Pubblici_Type**

diagram		
namespace	urn:www.agenziaentrate.gov.it:specificheTecniche:sco:730	
children	m730:Contributi m730:QuotaTFR	

element **Fondo_Pensione_Dipendenti_Pubblici_Type/Contributi**

diagram	
namespace	urn:www.agenziaentrate.gov.it:specificheTecniche:sco:730
type	m730:Contributi Previdenza Complementare Type
children	m730:EsclusiDalSostituto m730:NonEsclusiDalSostituto

element **Fondo_Pensione_Dipendenti_Pubblici_Type/QuotaTFR**

diagram					
namespace	urn:www.agenziaentrate.gov.it:specificheTecniche:sco:730				
type	DatoNP Type				
facets	<table border="1"> <tr> <td>Kind</td> <td>Value</td> </tr> <tr> <td>pattern</td> <td>[1-9]{1}[0-9]*</td> </tr> </table>	Kind	Value	pattern	[1-9]{1}[0-9]*
Kind	Value				
pattern	[1-9]{1}[0-9]*				

complexType **Frontespizio_730_Type**

diagram	
namespace	urn:www.agenziaentrate.gov.it:specificheTecniche:sco:730
children	m730:SoggettoFiscale m730:DatiAnagrafici m730:StatoCivile m730:ResidenzaAnagrafica m730:DomicilioFiscaleSaldo m730:DomicilioFiscaleAcconto m730:CasiParticolariAddizionale m730:Firma

element **Frontespizio_730_Type/SoggettoFiscale**

diagram	
namespace	urn:www.agenziaentrate.gov.it:specificheTecniche:sco:730
type	m730:Soggetto_Fiscale_730_Type
children	m730:CodiceFiscale m730:Email m730:Telefono m730:Cellulare

element **Frontespizio_730_Type/DatiAnagrafici**

diagram	
namespace	urn:www.agenziaentrate.gov.it:specificheTecniche:sco:730
type	Dati_Anagrafici_Type
children	Cognome Nome Sesso DataNascita ComuneNascita ProvinciaNascita

element **Frontespizio_730_Type/StatoCivile**

diagram									
namespace	urn:www.agenziaentrate.gov.it:specificheTecniche:sco:730								
type	m730:Stato_Civile_Type								
facets	<table border="1"> <thead> <tr> <th>Kind</th> <th>Value</th> </tr> </thead> <tbody> <tr> <td>pattern</td> <td>[1-9]{1}[0-9]*</td> </tr> <tr> <td>enumeration</td> <td>7</td> </tr> <tr> <td>enumeration</td> <td>8</td> </tr> </tbody> </table>	Kind	Value	pattern	[1-9]{1}[0-9]*	enumeration	7	enumeration	8
Kind	Value								
pattern	[1-9]{1}[0-9]*								
enumeration	7								
enumeration	8								

element **Frontespizio_730_Type/ResidenzaAnagrafica**

<p>diagram</p>	
<p>namespace</p>	<p>urn:www.agenziaentrate.gov.it:specificheTecniche:sco:730</p>
<p>type</p>	<p>m730:Residenza_Anagrafica_730_Type</p>
<p>children</p>	<p>Comune Provincia CodiceComune Indirizzo Cap DataVariazione m730:Tipologia m730:NumCivico m730:Frazione m730:PrimaPresentazione</p>

element **Frontespizio_730_Type/DomicilioFiscaleSaldo**

<p>diagram</p>	
<p>namespace</p>	<p>urn:www.agenziaentrate.gov.it:specificheTecniche:sco:730</p>
<p>type</p>	<p>m730:Domicilio_Fiscale_Type</p>
<p>children</p>	<p>m730:Comune m730:Provincia m730:CodiceComune</p>

element **Frontespizio_730_Type/DomicilioFiscaleAcconto**

diagram	
namespace	urn:www.agenziaentrate.gov.it:specificheTecniche:sco:730
type	m730:Domicilio_Fiscale_Acconto_Type
children	m730:Comune m730:Provincia m730:CodiceComune m730:FusioneComuni

element **Frontespizio_730_Type/CasiParticolariAddizionale**

diagram					
namespace	urn:www.agenziaentrate.gov.it:specificheTecniche:sco:730				
type	DatoCB_Type				
facets	<table border="1"> <thead> <tr> <th>Kind</th> <th>Value</th> </tr> </thead> <tbody> <tr> <td>pattern</td> <td>[01]</td> </tr> </tbody> </table>	Kind	Value	pattern	[01]
Kind	Value				
pattern	[01]				

element **Frontespizio_730_Type/Firma**

diagram	
namespace	urn:www.agenziaentrate.gov.it:specificheTecniche:sco:730
type	m730:Firma_Dichiarazione_Type
children	m730:NumeroModelli m730:FirmaDichiarazione m730:OpzioneInformativa m730:SoggettoFiscalmenteCarico m730:QuadroK

complexType Frontespizio_Con_Type

<p>diagram</p>	
<p>namespace</p>	<p>urn:www.agenziaentrate.gov.it:specificheTecniche:sco:730</p>
<p>type</p>	<p>extension of m730:Frontespizio 730 Type</p>
<p>children</p>	<p>m730:SoggettoFiscale m730:DatiAnagrafici m730:StatoCivile m730:ResidenzaAnagrafica m730:DomicilioFiscaleSaldo m730:DomicilioFiscaleAcconto m730:CasiParticolariAddizionale m730:Firma</p>

complexType Frontespizio_Dich_Type

<p>diagram</p>	
<p>namespace</p>	<p>urn:www.agenziaentrate.gov.it:specificheTecniche:sco:730</p>

type	extension of m730:Frontespizio 730 Type
children	m730:SoggettoFiscale m730:DatiAnagrafici m730:StatoCivile m730:ResidenzaAnagrafica m730:DomicilioFiscaleSaldo m730:DomicilioFiscaleAcconto m730:CasiParticolariAddizionale m730:Firma m730:Rappresentante

element Frontespizio_Dich_Type/Rappresentante

diagram	<p>The diagram shows a class m730:Rappresentante Type (dashed box) which is a composition (solid line with a hollow diamond) of four other classes: m730:SoggettoFiscale, m730:DatiAnagrafici, m730:ResidenzaAnagrafica, and m730:Firma. The first three classes are shown in dashed boxes, indicating they are also complex types or have further structure. The m730:Firma class is shown in a solid box, indicating it is a primitive or simple type.</p>
namespace	urn:www.agenziaentrate.gov.it:specificheTecniche:sco:730
type	m730:Rappresentante Type
children	m730:SoggettoFiscale m730:DatiAnagrafici m730:ResidenzaAnagrafica m730:Firma

complexType Fuori_Assistenza_Type

diagram	<p>The diagram shows a class Fuori_Assistenza_Type (solid box) which is a composition (solid line with a hollow diamond) of six other classes, all shown in dashed boxes: m730:AnomaliaDatianagrafici, m730:AnomaliaTerreni, m730:AnomaliaFabbricati, m730:AnomaliaLavDip, m730:AnomaliaAltriRedditi, and m730:AnomaliaQuadroF.</p>
namespace	urn:www.agenziaentrate.gov.it:specificheTecniche:sco:730
children	m730:AnomaliaDatianagrafici m730:AnomaliaTerreni m730:AnomaliaFabbricati m730:AnomaliaLavDip m730:AnomaliaAltriRedditi m730:AnomaliaQuadroF

element Fuori_Assistenza_Type/AnomaliaDatianagrafici

diagram	<p>The diagram shows a class m730:AnomaliaDatianagrafici (dashed box).</p>
namespace	urn:www.agenziaentrate.gov.it:specificheTecniche:sco:730
type	DatoCB Type

facets	Kind pattern	Value [01]
--------	-----------------	---------------

element **Fuori_Assistenza_Type/AnomaliaTerreni**

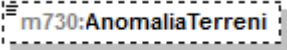
diagram		
namespace	urn:www.agenziaentrate.gov.it:specificheTecniche:sco:730	
type	DatoCB_Type	
facets	Kind pattern	Value [01]

element **Fuori_Assistenza_Type/AnomaliaFabbricati**

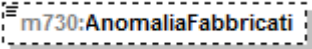
diagram		
namespace	urn:www.agenziaentrate.gov.it:specificheTecniche:sco:730	
type	DatoCB_Type	
facets	Kind pattern	Value [01]

element **Fuori_Assistenza_Type/AnomaliaLavDip**

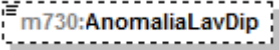
diagram		
namespace	urn:www.agenziaentrate.gov.it:specificheTecniche:sco:730	
type	DatoCB_Type	
facets	Kind pattern	Value [01]

element **Fuori_Assistenza_Type/AnomaliaAltriRedditi**

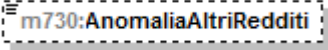
diagram		
namespace	urn:www.agenziaentrate.gov.it:specificheTecniche:sco:730	
type	DatoCB_Type	
facets	Kind pattern	Value [01]

element **Fuori_Assistenza_Type/AnomaliaQuadroF**

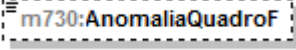
diagram		
namespace	urn:www.agenziaentrate.gov.it:specificheTecniche:sco:730	
type	DatoCB_Type	

facets	Kind pattern	Value [01]
--------	-----------------	---------------

complexType **Giorni_Percentuale_Type**

diagram	
namespace	urn:www.agenziaentrate.gov.it:specificheTecniche:sco:730
children	m730:Giorni m730:Percentuale

element **Giorni_Percentuale_Type/Giorni**

diagram		
namespace	urn:www.agenziaentrate.gov.it:specificheTecniche:sco:730	
type	DatoNP_Type	
facets	Kind pattern	Value [1-9]{1}[0-9]*

element **Giorni_Percentuale_Type/Percentuale**

diagram		
namespace	urn:www.agenziaentrate.gov.it:specificheTecniche:sco:730	
type	DatoPC_Type	
facets	Kind pattern	Value [0-9]?[0-9](, d{1,3})? 100(,0{1,3})?

complexType **Importi_Rimborsare_730-4_Integrativo_Type**

diagram	
namespace	urn:www.agenziaentrate.gov.it:specificheTecniche:sco:730
type	extension of m730:Importi_Rimborsare_730-4_Type
children	m730:IrpefRimborsare m730:AddRegRimborsare m730:AddComRimborsare m730:CedolareRimborsare m730:TassazioneSepRimborsare m730:PremiRisultatoRimborsare m730:ContributoSolidarieta

element **Importi_Rimborsare_730-4_Integrativo_Type/TassazioneSepRimborsare**

diagram	
namespace	urn:www.agenziaentrate.gov.it:specificheTecniche:sco:730
type	m730:Importo_730-4
children	m730:ImportoDichiarante m730:ImportoConiuge m730:ImportoTotale

element **Importi_Rimborsare_730-4_Integrativo_Type/PremiRisultatoRimborsare**

diagram	
namespace	urn:www.agenziaentrate.gov.it:specificheTecniche:sco:730
type	m730:Importo_730-4
children	m730:ImportoDichiarante m730:ImportoConiuge m730:ImportoTotale

element **Importi_Rimborsare_730-4_Integrativo_Type/ContributoSolidarieta**

diagram	
namespace	urn:www.agenziaentrate.gov.it:specificheTecniche:sco:730
type	m730:Importo_730-4
children	m730:ImportoDichiarante m730:ImportoConiuge m730:ImportoTotale

complexType **Importi_Rimborsare_730-4_Type**

diagram	
namespace	urn:www.agenziaentrate.gov.it:specificheTecniche:sco:730
children	m730:IrpefRimborsare m730:AddRegRimborsare m730:AddComRimborsare m730:CedolareRimborsare

element **Importi_Rimborsare_730-4_Type/ImportiRimborsare**

diagram	
namespace	urn:www.agenziaentrate.gov.it:specificheTecniche:sco:730
type	m730:Importo_730-4
children	m730:ImportoDichiarante m730:ImportoConiuge m730:ImportoTotale

element **Importi_Rimborsare_730-4_Type/AddRegRimborsare**

diagram	
namespace	urn:www.agenziaentrate.gov.it:specificheTecniche:sco:730
children	m730:ImportoAddizionale m730:CodiceRegioneDichiarante m730:CodiceRegioneConiuge

element **Importi_Rimborsare_730-4_Type/AddRegRimborsare/ImportoAddizionale**

diagram	
namespace	urn:www.agenziaentrate.gov.it:specificheTecniche:sco:730
type	m730:Importo_730-4
children	m730:ImportoDichiarante m730:ImportoConiuge m730:ImportoTotale

element **Importi_Rimborsare_730-4_Type/AddRegRimborsare/CodiceRegioneDichiarante**

diagram	
namespace	urn:www.agenziaentrate.gov.it:specificheTecniche:sco:730

type	Codice Regione Type	
facets	Kind	Value
	pattern	(([0-9A-Z-])"){1}([0-9A-Z&:] ' \\-\\. , / ^ \\^\\(\\ \\) À È É Ì Ò Ù Û " \\ \\ \\+)*
	enumeration	1
	enumeration	2
	enumeration	3
	enumeration	4
	enumeration	5
	enumeration	6
	enumeration	7
	enumeration	8
	enumeration	9
	enumeration	10
	enumeration	11
	enumeration	12
	enumeration	13
	enumeration	14
	enumeration	15
	enumeration	16
	enumeration	17
	enumeration	18
	enumeration	19
	enumeration	20
	enumeration	21

element **Importi_Rimborsare_730-4_Type/AddRegRimborsare/CodiceRegioneConiuge**

diagram		
namespace	urn:www.agenziaentrate.gov.it:specificheTecniche:sco:730	
type	Codice Regione Type	
facets	Kind	Value
	pattern	(([0-9A-Z-])"){1}([0-9A-Z&:] ' \\-\\. , / ^ \\^\\(\\ \\) À È É Ì Ò Ù Û " \\ \\ \\+)*
	enumeration	1
	enumeration	2
	enumeration	3
	enumeration	4
	enumeration	5
	enumeration	6
	enumeration	7
	enumeration	8
	enumeration	9
	enumeration	10
	enumeration	11
	enumeration	12
	enumeration	13
	enumeration	14
	enumeration	15
	enumeration	16
	enumeration	17
	enumeration	18
	enumeration	19
	enumeration	20
	enumeration	21

element **Importi_Rimborsare_730-4_Type/AddComRimborsare**

diagram	
namespace	urn:www.agenziaentrate.gov.it:specificheTecniche:sco:730
children	m730:ImportoAddizionale m730:CodiceComuneDichiarante m730:CodiceComuneConiuge

element **Importi_Rimborsare_730-4_Type/AddComRimborsare/ImportoAddizionale**

diagram	
namespace	urn:www.agenziaentrate.gov.it:specificheTecniche:sco:730
type	m730:Importo_730-4
children	m730:ImportoDichiarante m730:ImportoConiuge m730:ImportoTotale

element **Importi_Rimborsare_730-4_Type/AddComRimborsare/CodiceComuneDichiarante**

diagram					
namespace	urn:www.agenziaentrate.gov.it:specificheTecniche:sco:730				
type	DatoAN_Type				
facets	<table border="0"> <tr> <td>Kind</td> <td>Value</td> </tr> <tr> <td>pattern</td> <td>([0-9A-Z\-_]&quot;){1}([0-9A-Z&amp;:] \- \., / ^ \^\(\ \)\^ À È É Ì Ò Ù Ü &quot; \\ \ /+)*</td> </tr> </table>	Kind	Value	pattern	([0-9A-Z\-_]"){1}([0-9A-Z&:] \- \., / ^ \^\(\ \)\^ À È É Ì Ò Ù Ü " \\ \ /+)*
Kind	Value				
pattern	([0-9A-Z\-_]"){1}([0-9A-Z&:] \- \., / ^ \^\(\ \)\^ À È É Ì Ò Ù Ü " \\ \ /+)*				

element **Importi_Rimborsare_730-4_Type/AddComRimborsare/CodiceComuneConiuge**

diagram					
namespace	urn:www.agenziaentrate.gov.it:specificheTecniche:sco:730				
type	DatoAN_Type				
facets	<table border="0"> <tr> <td>Kind</td> <td>Value</td> </tr> <tr> <td>pattern</td> <td>([0-9A-Z\-_]&quot;){1}([0-9A-Z&amp;:] \- \., / ^ \^\(\ \)\^ À È É Ì Ò Ù Ü &quot; \\ \ /+)*</td> </tr> </table>	Kind	Value	pattern	([0-9A-Z\-_]"){1}([0-9A-Z&:] \- \., / ^ \^\(\ \)\^ À È É Ì Ò Ù Ü " \\ \ /+)*
Kind	Value				
pattern	([0-9A-Z\-_]"){1}([0-9A-Z&:] \- \., / ^ \^\(\ \)\^ À È É Ì Ò Ù Ü " \\ \ /+)*				

element **Importi_Rimborsare_730-4_Type/CedolareRimborsare**

diagram	
namespace	urn:www.agenziaentrate.gov.it:specificheTecniche:sco:730
type	m730:Importo_730-4
children	m730:ImportoDichiarante m730:ImportoConiuge m730:ImportoTotale

complexType **Importi_Trattenere_730-4_Type**

diagram	
namespace	urn:www.agenziaentrate.gov.it:specificheTecniche:sco:730
children	m730:IrpefTrattenere m730:AddRegTrattenere m730:AddComTrattenere m730:IrpefPrimaRataTrattenere m730:IrpefSecondaRataTrattenere m730:TassSepAccontoTrattenere m730:AddComAccontoTrattenere m730:PremiRisultatoTrattenere m730:CedolareTrattenere m730:CedolarePrimaRataTrattenere m730:CedolareSecondaRataTrattenere m730:ContribSolidTrattenere

element **Importi_Trattenere_730-4_Type/IrpefTrattenere**

diagram	
namespace	urn:www.agenziaentrate.gov.it:specificheTecniche:sco:730
type	m730:Importo_730-4
children	m730:ImportoDichiarante m730:ImportoConiuge m730:ImportoTotale

element **Importi_Trattenere_730-4_Type/AddRegTrattenere**

diagram	
namespace	urn:www.agenziaentrate.gov.it:specificheTecniche:sco:730
children	m730:ImportoAddizionale m730:CodiceRegioneDichiarante m730:CodiceRegioneConiuge

element **Importi_Trattenere_730-4_Type/AddRegTrattenere/ImportoAddizionale**

diagram	
namespace	urn:www.agenziaentrate.gov.it:specificheTecniche:sco:730
type	m730:Importo_730-4
children	m730:ImportoDichiarante m730:ImportoConiuge m730:ImportoTotale

element **Importi_Trattenere_730-4_Type/AddRegTrattenere/CodiceRegioneDichiarante**

diagram	
namespace	urn:www.agenziaentrate.gov.it:specificheTecniche:sco:730

type	Codice Regione Type	
facets	Kind	Value
	pattern	(([0-9A-Z-])"){1}([0-9A-Z&:] ' \\-\\. , / ^ \\^\\(\\ \\)\\ À È É Ì Ò Ù Ü "; \\ \\ \\+)*
	enumeration	1
	enumeration	2
	enumeration	3
	enumeration	4
	enumeration	5
	enumeration	6
	enumeration	7
	enumeration	8
	enumeration	9
	enumeration	10
	enumeration	11
	enumeration	12
	enumeration	13
	enumeration	14
	enumeration	15
	enumeration	16
	enumeration	17
	enumeration	18
	enumeration	19
	enumeration	20
	enumeration	21

element **Importi Tratteneri_730-4_Type/AddRegTratteneri/CodiceRegioneConiuge**

diagram		
namespace	urn:www.agenziaentrate.gov.it:specificheTecniche:sco:730	
type	Codice Regione Type	
facets	Kind	Value
	pattern	(([0-9A-Z-])"){1}([0-9A-Z&:] ' \\-\\. , / ^ \\^\\(\\ \\)\\ À È É Ì Ò Ù Ü "; \\ \\ \\+)*
	enumeration	1
	enumeration	2
	enumeration	3
	enumeration	4
	enumeration	5
	enumeration	6
	enumeration	7
	enumeration	8
	enumeration	9
	enumeration	10
	enumeration	11
	enumeration	12
	enumeration	13
	enumeration	14
	enumeration	15
	enumeration	16
	enumeration	17
	enumeration	18
	enumeration	19
	enumeration	20
	enumeration	21

element **Importi_Trattenerere_730-4_Type/AddComTrattenerere**

diagram	
namespace	urn:www.agenziaentrate.gov.it:specificheTecniche:sco:730
children	m730:ImportoAddizionale m730:CodiceComuneDichiarante m730:CodiceComuneConiuge

element **Importi_Trattenerere_730-4_Type/AddComTrattenerere/ImportoAddizionale**

diagram	
namespace	urn:www.agenziaentrate.gov.it:specificheTecniche:sco:730
type	m730:Importo_730-4
children	m730:ImportoDichiarante m730:ImportoConiuge m730:ImportoTotale

element **Importi_Trattenerere_730-4_Type/AddComTrattenerere/CodiceComuneDichiarante**

diagram					
namespace	urn:www.agenziaentrate.gov.it:specificheTecniche:sco:730				
type	DatoAN_Type				
facets	<table border="1"> <thead> <tr> <th>Kind</th> <th>Value</th> </tr> </thead> <tbody> <tr> <td>pattern</td> <td>([0-9A-Z\-\-]&quot;){1}([0-9A-Z&amp;:] \- \., / \° \^ \(\) À È É Ì Ò Ù Û &quot; \ \\ \ +)*</td> </tr> </tbody> </table>	Kind	Value	pattern	([0-9A-Z\-\-]"){1}([0-9A-Z&:] \- \., / \° \^ \(\) À È É Ì Ò Ù Û " \ \\ \ +)*
Kind	Value				
pattern	([0-9A-Z\-\-]"){1}([0-9A-Z&:] \- \., / \° \^ \(\) À È É Ì Ò Ù Û " \ \\ \ +)*				

element **Importi_Trattenerere_730-4_Type/AddComTrattenerere/CodiceComuneConiuge**

diagram					
namespace	urn:www.agenziaentrate.gov.it:specificheTecniche:sco:730				
type	DatoAN_Type				
facets	<table border="1"> <thead> <tr> <th>Kind</th> <th>Value</th> </tr> </thead> <tbody> <tr> <td>pattern</td> <td>([0-9A-Z\-\-]&quot;){1}([0-9A-Z&amp;:] \- \., / \° \^ \(\) À È É Ì Ò Ù Û &quot; \ \\ \ +)*</td> </tr> </tbody> </table>	Kind	Value	pattern	([0-9A-Z\-\-]"){1}([0-9A-Z&:] \- \., / \° \^ \(\) À È É Ì Ò Ù Û " \ \\ \ +)*
Kind	Value				
pattern	([0-9A-Z\-\-]"){1}([0-9A-Z&:] \- \., / \° \^ \(\) À È É Ì Ò Ù Û " \ \\ \ +)*				

element **Importi_Trattenere_730-4_Type/IrpefPrimaRataTrattenere**

diagram	
namespace	urn:www.agenziaentrate.gov.it:specificheTecniche:sco:730
type	m730:Importo_730-4
children	m730:ImportoDichiarante m730:ImportoConiuge m730:ImportoTotale

element **Importi_Trattenere_730-4_Type/IrpefSecondaRataTrattenere**

diagram	
namespace	urn:www.agenziaentrate.gov.it:specificheTecniche:sco:730
type	m730:Importo_730-4
children	m730:ImportoDichiarante m730:ImportoConiuge m730:ImportoTotale

element **Importi_Trattenere_730-4_Type/TassSepAccontoTrattenere**

diagram	
namespace	urn:www.agenziaentrate.gov.it:specificheTecniche:sco:730
type	m730:Importo_730-4
children	m730:ImportoDichiarante m730:ImportoConiuge m730:ImportoTotale

element **Importi_Trattenere_730-4_Type/AddComAccontoTrattenere**

diagram	
namespace	urn:www.agenziaentrate.gov.it:specificheTecniche:sco:730
children	m730:ImportoAddizionale m730:CodiceComuneDichiarante m730:CodiceComuneConiuge

element **Importi_Trattenere_730-4_Type/AddComAccontoTrattenere/ImportoAddizionale**

diagram	
namespace	urn:www.agenziaentrate.gov.it:specificheTecniche:sco:730
type	m730:Importo_730-4
children	m730:ImportoDichiarante m730:ImportoConiuge m730:ImportoTotale

element **Importi_Trattenere_730-4_Type/AddComAccontoTrattenere/CodiceComuneDichiarante**

diagram					
namespace	urn:www.agenziaentrate.gov.it:specificheTecniche:sco:730				
type	DatoAN_Type				
facets	<table border="1"> <thead> <tr> <th>Kind</th> <th>Value</th> </tr> </thead> <tbody> <tr> <td>pattern</td> <td>([0-9A-Z\-\ &quot;]{1})([0-9A-Z&amp;:] '\- \., / ^\\(\\) À È É Ì Ò Ù Û &quot; \\ \\ \\+)*</td> </tr> </tbody> </table>	Kind	Value	pattern	([0-9A-Z\-\ "]{1})([0-9A-Z&:] '\- \., / ^\\(\\) À È É Ì Ò Ù Û " \\ \\ \\+)*
Kind	Value				
pattern	([0-9A-Z\-\ "]{1})([0-9A-Z&:] '\- \., / ^\\(\\) À È É Ì Ò Ù Û " \\ \\ \\+)*				

element **Importi_Trattenere_730-4_Type/AddComAccontoTrattenere/CodiceComuneConiuge**

diagram					
namespace	urn:www.agenziaentrate.gov.it:specificheTecniche:sco:730				
type	DatoAN_Type				
facets	<table border="1"> <thead> <tr> <th>Kind</th> <th>Value</th> </tr> </thead> <tbody> <tr> <td>pattern</td> <td>([0-9A-Z\-\ &quot;]{1})([0-9A-Z&amp;:] '\- \., / ^\\(\\) À È É Ì Ò Ù Û &quot; \\ \\ \\+)*</td> </tr> </tbody> </table>	Kind	Value	pattern	([0-9A-Z\-\ "]{1})([0-9A-Z&:] '\- \., / ^\\(\\) À È É Ì Ò Ù Û " \\ \\ \\+)*
Kind	Value				
pattern	([0-9A-Z\-\ "]{1})([0-9A-Z&:] '\- \., / ^\\(\\) À È É Ì Ò Ù Û " \\ \\ \\+)*				

element **Importi_Trattenere_730-4_Type/PremiRisultatoTrattenere**

diagram	
namespace	urn:www.agenziaentrate.gov.it:specificheTecniche:sco:730
type	m730:Importo_730-4
children	m730:ImportoDichiarante m730:ImportoConiuge m730:ImportoTotale

element **Importi_Trattenere_730-4_Type/CedolareTrattenere**

diagram	
namespace	urn:www.agenziaentrate.gov.it:specificheTecniche:sco:730
type	m730:Importo_730-4
children	m730:ImportoDichiarante m730:ImportoConiuge m730:ImportoTotale

element **Importi_Trattenere_730-4_Type/CedolarePrimaRataTrattenere**

diagram	
namespace	urn:www.agenziaentrate.gov.it:specificheTecniche:sco:730
type	m730:Importo_730-4
children	m730:ImportoDichiarante m730:ImportoConiuge m730:ImportoTotale

element **Importi_Trattenere_730-4_Type/CedolareSecondaRataTrattenere**

diagram	
namespace	urn:www.agenziaentrate.gov.it:specificheTecniche:sco:730
type	m730:Importo_730-4
children	m730:ImportoDichiarante m730:ImportoConiuge m730:ImportoTotale

element **Importi_Trattenere_730-4_Type/ContribSolidTrattenere**

diagram	
namespace	urn:www.agenziaentrate.gov.it:specificheTecniche:sco:730
type	m730:Importo_730-4
children	m730:ImportoDichiarante m730:ImportoConiuge m730:ImportoTotale

complexType **Importo_730-4**

diagram	
namespace	urn:www.agenziaentrate.gov.it:specificheTecniche:sco:730
children	m730:ImportoDichiarante m730:ImportoConiuge m730:ImportoTotale

element **Importo_730-4/ImportoDichiarante**

diagram	
namespace	urn:www.agenziaentrate.gov.it:specificheTecniche:sco:730

type	DatoNP_Type
facets	Kind Value pattern [1-9]{1}[0-9]*

element **Importo_730-4/ImportoConiuge**

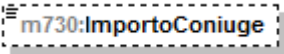
diagram	
namespace	urn:www.agenziaentrate.gov.it:specificheTecniche:sco:730
type	DatoNP_Type
facets	Kind Value pattern [1-9]{1}[0-9]*

element **Importo_730-4/ImportoTotale**

diagram	
namespace	urn:www.agenziaentrate.gov.it:specificheTecniche:sco:730
type	DatoNP_Type
facets	Kind Value pattern [1-9]{1}[0-9]*

complexType **Imposta_Lorda_Type**

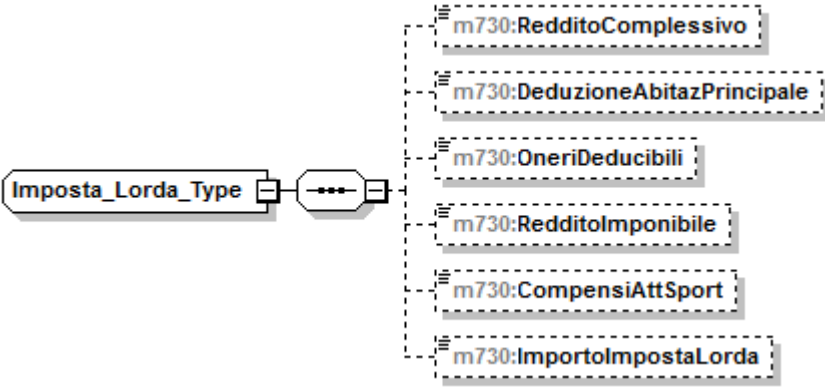
diagram	
namespace	urn:www.agenziaentrate.gov.it:specificheTecniche:sco:730
children	m730:RedditoComplessivo m730:DeduzioneAbitazPrincipale m730:OneriDeducibili m730:RedditoImponibile m730:CompensiAttSport m730:ImportoImpostaLorda

element **Imposta_Lorda_Type/RedditoComplessivo**

diagram	
namespace	urn:www.agenziaentrate.gov.it:specificheTecniche:sco:730
type	DatoNP_Type

facets	Kind Value pattern [1-9]{1}[0-9]*
--------	--------------------------------------

element **Imposta_Lorda_Type/DeduzioneAbitazPrincipale**

diagram	 m730:DeduzioneAbitazPrincipale
namespace	urn:www.agenziaentrate.gov.it:specificheTecniche:sco:730
type	DatoNP_Type
facets	Kind Value pattern [1-9]{1}[0-9]*

element **Imposta_Lorda_Type/OneriDeducibili**

diagram	 m730:OneriDeducibili
namespace	urn:www.agenziaentrate.gov.it:specificheTecniche:sco:730
type	DatoNP_Type
facets	Kind Value pattern [1-9]{1}[0-9]*

element **Imposta_Lorda_Type/RedditolImponibile**

diagram	 m730:RedditolImponibile
namespace	urn:www.agenziaentrate.gov.it:specificheTecniche:sco:730
type	DatoNP_Type
facets	Kind Value pattern [1-9]{1}[0-9]*

element **Imposta_Lorda_Type/CompensiAttSport**

diagram	 m730:CompensiAttSport
namespace	urn:www.agenziaentrate.gov.it:specificheTecniche:sco:730
type	DatoNP_Type
facets	Kind Value pattern [1-9]{1}[0-9]*

element **Imposta_Lorda_Type/ImportolImpostaLorda**

diagram	 m730:ImportolImpostaLorda
namespace	urn:www.agenziaentrate.gov.it:specificheTecniche:sco:730
type	DatoNP_Type

facets	Kind	Value
	pattern	[1-9]{1}[0-9]*

complexType **Imposta_Netta_Type**

<p>diagram</p>	
<p>namespace</p>	<p>urn:www.agenziaentrate.gov.it:specificheTecniche:sco:730</p>
<p>children</p>	<p>m730:ImportoImpostaNetta m730:CredAltriSisma m730:CredAbitazSisma m730:CredImpEstere m730:CredErogCultura m730:CredErogScuola m730:CredVideosorveglianza m730:CredCanNonPerc m730:CredDetrazIncapienti m730:Ritenute m730:Differenza m730:Eccedenzalrpef m730:AccontiVersati m730:RestituzioneBonus m730:CredRimborsatiSost m730:BonuslrpefSpettante m730:BonuslrpefRiconosciuto m730:RestituzioneBonuslrpef</p>

element **Imposta_Netta_Type/ImportoImpostaNetta**

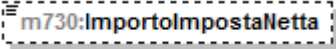
diagram	
namespace	urn:www.agenziaentrate.gov.it:specificheTecniche:sco:730
type	DatoNP_Type
facets	Kind Value pattern [1-9]{1}[0-9]*

element **Imposta_Netta_Type/CredAltriSisma**

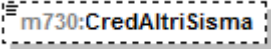
diagram	
namespace	urn:www.agenziaentrate.gov.it:specificheTecniche:sco:730
type	DatoNP_Type
facets	Kind Value pattern [1-9]{1}[0-9]*

element **Imposta_Netta_Type/CredAbitazSisma**

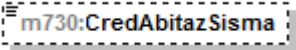
diagram	
namespace	urn:www.agenziaentrate.gov.it:specificheTecniche:sco:730
type	DatoNP_Type
facets	Kind Value pattern [1-9]{1}[0-9]*

element **Imposta_Netta_Type/CredImpEstere**

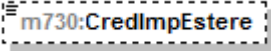
diagram	
namespace	urn:www.agenziaentrate.gov.it:specificheTecniche:sco:730
type	DatoNP_Type
facets	Kind Value pattern [1-9]{1}[0-9]*

element **Imposta_Netta_Type/CredErogCultura**

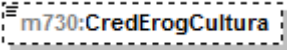
diagram	
namespace	urn:www.agenziaentrate.gov.it:specificheTecniche:sco:730
type	DatoNP_Type
facets	Kind Value pattern [1-9]{1}[0-9]*

element **Imposta_Netta_Type/CredErogScuola**

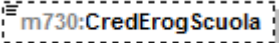
diagram					
namespace	urn:www.agenziaentrate.gov.it:specificheTecniche:sco:730				
type	DatoNP_Type				
facets	<table border="1"> <tr> <td>Kind</td> <td>Value</td> </tr> <tr> <td>pattern</td> <td>[1-9]{1}[0-9]*</td> </tr> </table>	Kind	Value	pattern	[1-9]{1}[0-9]*
Kind	Value				
pattern	[1-9]{1}[0-9]*				

element **Imposta_Netta_Type/CredVideosorveglianza**

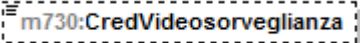
diagram					
namespace	urn:www.agenziaentrate.gov.it:specificheTecniche:sco:730				
type	DatoNP_Type				
facets	<table border="1"> <tr> <td>Kind</td> <td>Value</td> </tr> <tr> <td>pattern</td> <td>[1-9]{1}[0-9]*</td> </tr> </table>	Kind	Value	pattern	[1-9]{1}[0-9]*
Kind	Value				
pattern	[1-9]{1}[0-9]*				

element **Imposta_Netta_Type/CredCanNonPerc**

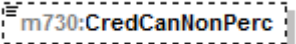
diagram					
namespace	urn:www.agenziaentrate.gov.it:specificheTecniche:sco:730				
type	DatoNP_Type				
facets	<table border="1"> <tr> <td>Kind</td> <td>Value</td> </tr> <tr> <td>pattern</td> <td>[1-9]{1}[0-9]*</td> </tr> </table>	Kind	Value	pattern	[1-9]{1}[0-9]*
Kind	Value				
pattern	[1-9]{1}[0-9]*				

element **Imposta_Netta_Type/CredDetrazIncapienti**

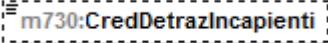
diagram					
namespace	urn:www.agenziaentrate.gov.it:specificheTecniche:sco:730				
type	DatoNP_Type				
facets	<table border="1"> <tr> <td>Kind</td> <td>Value</td> </tr> <tr> <td>pattern</td> <td>[1-9]{1}[0-9]*</td> </tr> </table>	Kind	Value	pattern	[1-9]{1}[0-9]*
Kind	Value				
pattern	[1-9]{1}[0-9]*				

element **Imposta_Netta_Type/Ritenute**

diagram					
namespace	urn:www.agenziaentrate.gov.it:specificheTecniche:sco:730				
type	DatoNP_Type				
facets	<table border="1"> <tr> <td>Kind</td> <td>Value</td> </tr> <tr> <td>pattern</td> <td>[1-9]{1}[0-9]*</td> </tr> </table>	Kind	Value	pattern	[1-9]{1}[0-9]*
Kind	Value				
pattern	[1-9]{1}[0-9]*				

element **Imposta_Netta_Type/Differenza**

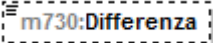
diagram	
namespace	urn:www.agenziaentrate.gov.it:specificheTecniche:sco:730
type	DatoNU_Type
facets	Kind Value pattern $(\{-[1-9]\}\{1-9\})[0-9]^*$

element **Imposta_Netta_Type/Eccedenzalrpef**

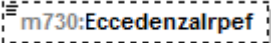
diagram	
namespace	urn:www.agenziaentrate.gov.it:specificheTecniche:sco:730
type	DatoNU_Type
facets	Kind Value pattern $(\{-[1-9]\}\{1-9\})[0-9]^*$

element **Imposta_Netta_Type/AccontiVersati**

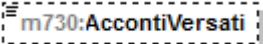
diagram	
namespace	urn:www.agenziaentrate.gov.it:specificheTecniche:sco:730
type	DatoNP_Type
facets	Kind Value pattern $[1-9]\{1\}[0-9]^*$

element **Imposta_Netta_Type/RestituzioneBonus**

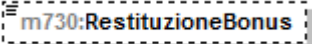
diagram	
namespace	urn:www.agenziaentrate.gov.it:specificheTecniche:sco:730
type	DatoNP_Type
facets	Kind Value pattern $[1-9]\{1\}[0-9]^*$

element **Imposta_Netta_Type/CredRimborsatiSost**

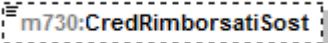
diagram	
namespace	urn:www.agenziaentrate.gov.it:specificheTecniche:sco:730
type	DatoNP_Type
facets	Kind Value pattern $[1-9]\{1\}[0-9]^*$

element **Imposta_Netta_Type/BonusIrpefSpettante**

diagram					
namespace	urn:www.agenziaentrate.gov.it:specificheTecniche:sco:730				
type	DatoNP_Type				
facets	<table border="1"> <tr> <td>Kind</td> <td>Value</td> </tr> <tr> <td>pattern</td> <td>[1-9]{1}[0-9]*</td> </tr> </table>	Kind	Value	pattern	[1-9]{1}[0-9]*
Kind	Value				
pattern	[1-9]{1}[0-9]*				

element **Imposta_Netta_Type/BonusIrpefRiconosciuto**

diagram					
namespace	urn:www.agenziaentrate.gov.it:specificheTecniche:sco:730				
type	DatoNP_Type				
facets	<table border="1"> <tr> <td>Kind</td> <td>Value</td> </tr> <tr> <td>pattern</td> <td>[1-9]{1}[0-9]*</td> </tr> </table>	Kind	Value	pattern	[1-9]{1}[0-9]*
Kind	Value				
pattern	[1-9]{1}[0-9]*				

element **Imposta_Netta_Type/RestituzioneBonusIrpef**

diagram					
namespace	urn:www.agenziaentrate.gov.it:specificheTecniche:sco:730				
type	DatoNP_Type				
facets	<table border="1"> <tr> <td>Kind</td> <td>Value</td> </tr> <tr> <td>pattern</td> <td>[1-9]{1}[0-9]*</td> </tr> </table>	Kind	Value	pattern	[1-9]{1}[0-9]*
Kind	Value				
pattern	[1-9]{1}[0-9]*				

complexType **Imposte_Rimborsate_Type**

diagram	
namespace	urn:www.agenziaentrate.gov.it:specificheTecniche:sco:730
children	m730:TipoReddito m730:TassazioneSeparata

element **Imposte_Rimborsate_Type/TipoReddito**

diagram											
namespace	urn:www.agenziaentrate.gov.it:specificheTecniche:sco:730										
type	m730:Tipo_Reddito_Da1a8_Type										
facets	<table border="1"> <tr> <td>Kind</td> <td>Value</td> </tr> <tr> <td>pattern</td> <td>[1-9]{1}[0-9]*</td> </tr> <tr> <td>enumeration</td> <td>1</td> </tr> <tr> <td>enumeration</td> <td>2</td> </tr> <tr> <td>enumeration</td> <td>3</td> </tr> </table>	Kind	Value	pattern	[1-9]{1}[0-9]*	enumeration	1	enumeration	2	enumeration	3
Kind	Value										
pattern	[1-9]{1}[0-9]*										
enumeration	1										
enumeration	2										
enumeration	3										

	enumeration	4
	enumeration	5
	enumeration	6
	enumeration	7
	enumeration	8

element **Imposte_Rimborsate_Type/TassazioneSeparata**

diagram	
namespace	urn:www.agenziaentrate.gov.it:specificheTecniche:sco:730
type	m730:Tassazione Separata Type
children	m730:Opzione m730:Anno m730:RedditoRitenute

complexType **Inquilini_Abitazione_Principale_Type**

diagram	
namespace	urn:www.agenziaentrate.gov.it:specificheTecniche:sco:730
children	m730:Tipologia m730:GiorniPercentuale

element **Inquilini_Abitazione_Principale_Type/Tipologia**

diagram													
namespace	urn:www.agenziaentrate.gov.it:specificheTecniche:sco:730												
type	m730:Tipo Inquilino Type												
facets	<table border="1"> <thead> <tr> <th>Kind</th> <th>Value</th> </tr> </thead> <tbody> <tr> <td>pattern</td> <td>[1-9]{1}[0-9]*</td> </tr> <tr> <td>enumeration</td> <td>1</td> </tr> <tr> <td>enumeration</td> <td>2</td> </tr> <tr> <td>enumeration</td> <td>3</td> </tr> <tr> <td>enumeration</td> <td>4</td> </tr> </tbody> </table>	Kind	Value	pattern	[1-9]{1}[0-9]*	enumeration	1	enumeration	2	enumeration	3	enumeration	4
Kind	Value												
pattern	[1-9]{1}[0-9]*												
enumeration	1												
enumeration	2												
enumeration	3												
enumeration	4												

element **Inquilini_Abitazione_Principale_Type/GiorniPercentuale**

diagram	
namespace	urn:www.agenziaentrate.gov.it:specificheTecniche:sco:730
type	m730:Giorni_Percentuale_Type
children	m730:Giorni m730:Percentuale

complexType **Intervento_Recupero_Patrimonio_Edilizio_Type**

diagram	
namespace	urn:www.agenziaentrate.gov.it:specificheTecniche:sco:730
children	m730:Anno m730:Periodo m730:CodiceFiscale m730:CasellaInterventiParticolari m730:CodiceSituazioniParticolari m730:Rate10 m730:Spesa m730:NOrdineImmobile

element **Intervento_Recupero_Patrimonio_Edilizio_Type/Anno**

diagram																					
namespace	urn:www.agenziaentrate.gov.it:specificheTecniche:sco:730																				
type	m730:Anno_Recupero_Patrimonio_Edilizio_Type																				
facets	<table border="1"> <thead> <tr> <th>Kind</th> <th>Value</th> </tr> </thead> <tbody> <tr> <td>pattern</td> <td>[1-9]{1}[0-9]*</td> </tr> <tr> <td>enumeration</td> <td>2007</td> </tr> <tr> <td>enumeration</td> <td>2008</td> </tr> <tr> <td>enumeration</td> <td>2009</td> </tr> <tr> <td>enumeration</td> <td>2010</td> </tr> <tr> <td>enumeration</td> <td>2011</td> </tr> <tr> <td>enumeration</td> <td>2012</td> </tr> <tr> <td>enumeration</td> <td>2013</td> </tr> <tr> <td>enumeration</td> <td>2014</td> </tr> </tbody> </table>	Kind	Value	pattern	[1-9]{1}[0-9]*	enumeration	2007	enumeration	2008	enumeration	2009	enumeration	2010	enumeration	2011	enumeration	2012	enumeration	2013	enumeration	2014
Kind	Value																				
pattern	[1-9]{1}[0-9]*																				
enumeration	2007																				
enumeration	2008																				
enumeration	2009																				
enumeration	2010																				
enumeration	2011																				
enumeration	2012																				
enumeration	2013																				
enumeration	2014																				

	enumeration 2015
	enumeration 2016

element **Intervento_Ricupero_Patrimonio_Edilizio_Type/Periodo**

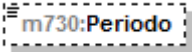
diagram											
namespace	urn:www.agenziaentrate.gov.it:specificheTecniche:sco:730										
type	m730:Periodo Spese Ristrutturazione Type										
facets	<table border="1"> <thead> <tr> <th>Kind</th> <th>Value</th> </tr> </thead> <tbody> <tr> <td>pattern</td> <td>[1-9]</td> </tr> <tr> <td>enumeration</td> <td>2</td> </tr> <tr> <td>enumeration</td> <td>3</td> </tr> <tr> <td>enumeration</td> <td>4</td> </tr> </tbody> </table>	Kind	Value	pattern	[1-9]	enumeration	2	enumeration	3	enumeration	4
Kind	Value										
pattern	[1-9]										
enumeration	2										
enumeration	3										
enumeration	4										

element **Intervento_Ricupero_Patrimonio_Edilizio_Type/CodiceFiscale**

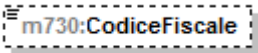
diagram					
namespace	urn:www.agenziaentrate.gov.it:specificheTecniche:sco:730				
type	DatoCF Type				
facets	<table border="1"> <thead> <tr> <th>Kind</th> <th>Value</th> </tr> </thead> <tbody> <tr> <td>pattern</td> <td>[0-9]{11}[A-Z]{6}[0-9LMNPQRSTUVWXYZ]{2}[A-Z]{1}[0-9LMNPQRSTUVWXYZ]{2}[A-Z]{1}[0-9LMNPQRSTUVWXYZ]{3}[A-Z]{1}</td> </tr> </tbody> </table>	Kind	Value	pattern	[0-9]{11}[A-Z]{6}[0-9LMNPQRSTUVWXYZ]{2}[A-Z]{1}[0-9LMNPQRSTUVWXYZ]{2}[A-Z]{1}[0-9LMNPQRSTUVWXYZ]{3}[A-Z]{1}
Kind	Value				
pattern	[0-9]{11}[A-Z]{6}[0-9LMNPQRSTUVWXYZ]{2}[A-Z]{1}[0-9LMNPQRSTUVWXYZ]{2}[A-Z]{1}[0-9LMNPQRSTUVWXYZ]{3}[A-Z]{1}				

element **Intervento_Ricupero_Patrimonio_Edilizio_Type/CasellaInterventiParticolari**

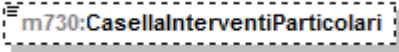
diagram									
namespace	urn:www.agenziaentrate.gov.it:specificheTecniche:sco:730								
type	restriction of DatoN1 Type								
facets	<table border="1"> <thead> <tr> <th>Kind</th> <th>Value</th> </tr> </thead> <tbody> <tr> <td>pattern</td> <td>[1-9]</td> </tr> <tr> <td>enumeration</td> <td>1</td> </tr> <tr> <td>enumeration</td> <td>4</td> </tr> </tbody> </table>	Kind	Value	pattern	[1-9]	enumeration	1	enumeration	4
Kind	Value								
pattern	[1-9]								
enumeration	1								
enumeration	4								

element **Intervento_Ricupero_Patrimonio_Edilizio_Type/CodiceSituazioniParticolari**

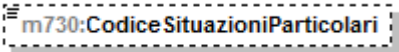
diagram							
namespace	urn:www.agenziaentrate.gov.it:specificheTecniche:sco:730						
type	restriction of DatoN1 Type						
facets	<table border="1"> <thead> <tr> <th>Kind</th> <th>Value</th> </tr> </thead> <tbody> <tr> <td>pattern</td> <td>[1-9]</td> </tr> <tr> <td>enumeration</td> <td>4</td> </tr> </tbody> </table>	Kind	Value	pattern	[1-9]	enumeration	4
Kind	Value						
pattern	[1-9]						
enumeration	4						

element **Intervento_Ricupero_Patrimonio_Edificio_Type/Rate10**

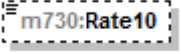
diagram																									
namespace	urn:www.agenziaentrate.gov.it:specificheTecniche:sco:730																								
type	m730:Rate10_Type																								
facets	<table border="1"> <thead> <tr> <th>Kind</th> <th>Value</th> </tr> </thead> <tbody> <tr> <td>pattern</td> <td>[1-9]{1}[0-9]*</td> </tr> <tr> <td>enumeration</td> <td>1</td> </tr> <tr> <td>enumeration</td> <td>2</td> </tr> <tr> <td>enumeration</td> <td>3</td> </tr> <tr> <td>enumeration</td> <td>4</td> </tr> <tr> <td>enumeration</td> <td>5</td> </tr> <tr> <td>enumeration</td> <td>6</td> </tr> <tr> <td>enumeration</td> <td>7</td> </tr> <tr> <td>enumeration</td> <td>8</td> </tr> <tr> <td>enumeration</td> <td>9</td> </tr> <tr> <td>enumeration</td> <td>10</td> </tr> </tbody> </table>	Kind	Value	pattern	[1-9]{1}[0-9]*	enumeration	1	enumeration	2	enumeration	3	enumeration	4	enumeration	5	enumeration	6	enumeration	7	enumeration	8	enumeration	9	enumeration	10
Kind	Value																								
pattern	[1-9]{1}[0-9]*																								
enumeration	1																								
enumeration	2																								
enumeration	3																								
enumeration	4																								
enumeration	5																								
enumeration	6																								
enumeration	7																								
enumeration	8																								
enumeration	9																								
enumeration	10																								

element **Intervento_Ricupero_Patrimonio_Edificio_Type/Spesa**

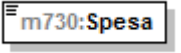
diagram					
namespace	urn:www.agenziaentrate.gov.it:specificheTecniche:sco:730				
type	DatoNP_Type				
facets	<table border="1"> <thead> <tr> <th>Kind</th> <th>Value</th> </tr> </thead> <tbody> <tr> <td>pattern</td> <td>[1-9]{1}[0-9]*</td> </tr> </tbody> </table>	Kind	Value	pattern	[1-9]{1}[0-9]*
Kind	Value				
pattern	[1-9]{1}[0-9]*				

element **Intervento_Ricupero_Patrimonio_Edificio_Type/NOrdineImmobile**

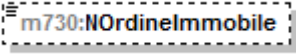
diagram					
namespace	urn:www.agenziaentrate.gov.it:specificheTecniche:sco:730				
type	DatoNP_Type				
facets	<table border="1"> <thead> <tr> <th>Kind</th> <th>Value</th> </tr> </thead> <tbody> <tr> <td>pattern</td> <td>[1-9]{1}[0-9]*</td> </tr> </tbody> </table>	Kind	Value	pattern	[1-9]{1}[0-9]*
Kind	Value				
pattern	[1-9]{1}[0-9]*				

complexType **Intervento_Risparmio_Energetico_Type**

diagram	
namespace	urn:www.agenziaentrate.gov.it:specificheTecniche:sco:730
children	m730:TipIntervento m730:Anno m730:Periodo2013 m730:CasiParticolari m730:RideterminazioneRate m730:RipartizioneRate m730:NumeroRata m730:Spesa

element **Intervento_Risparmio_Energetico_Type/TipIntervento**

diagram																			
namespace	urn:www.agenziaentrate.gov.it:specificheTecniche:sco:730																		
type	m730:Tipo_Intervento_Type																		
facets	<table border="1"> <thead> <tr> <th>Kind</th> <th>Value</th> </tr> </thead> <tbody> <tr> <td>pattern</td> <td>[1-9]</td> </tr> <tr> <td>enumeration</td> <td>1</td> </tr> <tr> <td>enumeration</td> <td>2</td> </tr> <tr> <td>enumeration</td> <td>3</td> </tr> <tr> <td>enumeration</td> <td>4</td> </tr> <tr> <td>enumeration</td> <td>5</td> </tr> <tr> <td>enumeration</td> <td>6</td> </tr> <tr> <td>enumeration</td> <td>7</td> </tr> </tbody> </table>	Kind	Value	pattern	[1-9]	enumeration	1	enumeration	2	enumeration	3	enumeration	4	enumeration	5	enumeration	6	enumeration	7
Kind	Value																		
pattern	[1-9]																		
enumeration	1																		
enumeration	2																		
enumeration	3																		
enumeration	4																		
enumeration	5																		
enumeration	6																		
enumeration	7																		

element **Intervento_Risparmio_Energetico_Type/Anno**

diagram																			
namespace	urn:www.agenziaentrate.gov.it:specificheTecniche:sco:730																		
type	m730:Anno_Risparmio_Energetico_Type																		
facets	<table border="1"> <thead> <tr> <th>Kind</th> <th>Value</th> </tr> </thead> <tbody> <tr> <td>pattern</td> <td>[1-9]{1}[0-9]*</td> </tr> <tr> <td>enumeration</td> <td>2008</td> </tr> <tr> <td>enumeration</td> <td>2011</td> </tr> <tr> <td>enumeration</td> <td>2012</td> </tr> <tr> <td>enumeration</td> <td>2013</td> </tr> <tr> <td>enumeration</td> <td>2014</td> </tr> <tr> <td>enumeration</td> <td>2015</td> </tr> <tr> <td>enumeration</td> <td>2016</td> </tr> </tbody> </table>	Kind	Value	pattern	[1-9]{1}[0-9]*	enumeration	2008	enumeration	2011	enumeration	2012	enumeration	2013	enumeration	2014	enumeration	2015	enumeration	2016
Kind	Value																		
pattern	[1-9]{1}[0-9]*																		
enumeration	2008																		
enumeration	2011																		
enumeration	2012																		
enumeration	2013																		
enumeration	2014																		
enumeration	2015																		
enumeration	2016																		

element **Intervento_Risparmio_Energetico_Type/Periodo2013**

diagram	 m730:Periodo2013								
namespace	urn:www.agenziaentrate.gov.it:specificheTecniche:sco:730								
type	restriction of DatoN1_Type								
facets	<table> <thead> <tr> <th>Kind</th> <th>Value</th> </tr> </thead> <tbody> <tr> <td>pattern</td> <td>[1-9]</td> </tr> <tr> <td>enumeration</td> <td>1</td> </tr> <tr> <td>enumeration</td> <td>2</td> </tr> </tbody> </table>	Kind	Value	pattern	[1-9]	enumeration	1	enumeration	2
Kind	Value								
pattern	[1-9]								
enumeration	1								
enumeration	2								

element **Intervento_Risparmio_Energetico_Type/CasiParticolari**

diagram	 m730:CasiParticolari										
namespace	urn:www.agenziaentrate.gov.it:specificheTecniche:sco:730										
type	m730:Casi_Particolari_Risp_Ener_Type										
facets	<table> <thead> <tr> <th>Kind</th> <th>Value</th> </tr> </thead> <tbody> <tr> <td>pattern</td> <td>[1-9]</td> </tr> <tr> <td>enumeration</td> <td>1</td> </tr> <tr> <td>enumeration</td> <td>2</td> </tr> <tr> <td>enumeration</td> <td>3</td> </tr> </tbody> </table>	Kind	Value	pattern	[1-9]	enumeration	1	enumeration	2	enumeration	3
Kind	Value										
pattern	[1-9]										
enumeration	1										
enumeration	2										
enumeration	3										

element **Intervento_Risparmio_Energetico_Type/RideterminazioneRate**

diagram	 m730:RideterminazioneRate																		
namespace	urn:www.agenziaentrate.gov.it:specificheTecniche:sco:730																		
type	m730:Rate_Risparmio_Energetico_Type																		
facets	<table> <thead> <tr> <th>Kind</th> <th>Value</th> </tr> </thead> <tbody> <tr> <td>pattern</td> <td>[1-9]{1}[0-9]*</td> </tr> <tr> <td>enumeration</td> <td>4</td> </tr> <tr> <td>enumeration</td> <td>5</td> </tr> <tr> <td>enumeration</td> <td>6</td> </tr> <tr> <td>enumeration</td> <td>7</td> </tr> <tr> <td>enumeration</td> <td>8</td> </tr> <tr> <td>enumeration</td> <td>9</td> </tr> <tr> <td>enumeration</td> <td>10</td> </tr> </tbody> </table>	Kind	Value	pattern	[1-9]{1}[0-9]*	enumeration	4	enumeration	5	enumeration	6	enumeration	7	enumeration	8	enumeration	9	enumeration	10
Kind	Value																		
pattern	[1-9]{1}[0-9]*																		
enumeration	4																		
enumeration	5																		
enumeration	6																		
enumeration	7																		
enumeration	8																		
enumeration	9																		
enumeration	10																		

element **Intervento_Risparmio_Energetico_Type/RipartizioneRate**

diagram	 m730:RipartizioneRate								
namespace	urn:www.agenziaentrate.gov.it:specificheTecniche:sco:730								
type	m730:Ripart_Risparmio_Energetico_Type								
facets	<table> <thead> <tr> <th>Kind</th> <th>Value</th> </tr> </thead> <tbody> <tr> <td>pattern</td> <td>[1-9]{1}[0-9]*</td> </tr> <tr> <td>enumeration</td> <td>9</td> </tr> <tr> <td>enumeration</td> <td>10</td> </tr> </tbody> </table>	Kind	Value	pattern	[1-9]{1}[0-9]*	enumeration	9	enumeration	10
Kind	Value								
pattern	[1-9]{1}[0-9]*								
enumeration	9								
enumeration	10								

element **Intervento_Risparmio_Energetico_Type/NumeroRata**

diagram																			
namespace	urn:www.agenziaentrate.gov.it:specificheTecniche:sco:730																		
type	m730:Numero Rata Risparmio Energetico Type																		
facets	<table border="1"> <thead> <tr> <th>Kind</th> <th>Value</th> </tr> </thead> <tbody> <tr> <td>pattern</td> <td>[1-9]{1}[0-9]*</td> </tr> <tr> <td>enumeration</td> <td>1</td> </tr> <tr> <td>enumeration</td> <td>2</td> </tr> <tr> <td>enumeration</td> <td>3</td> </tr> <tr> <td>enumeration</td> <td>4</td> </tr> <tr> <td>enumeration</td> <td>5</td> </tr> <tr> <td>enumeration</td> <td>6</td> </tr> <tr> <td>enumeration</td> <td>9</td> </tr> </tbody> </table>	Kind	Value	pattern	[1-9]{1}[0-9]*	enumeration	1	enumeration	2	enumeration	3	enumeration	4	enumeration	5	enumeration	6	enumeration	9
Kind	Value																		
pattern	[1-9]{1}[0-9]*																		
enumeration	1																		
enumeration	2																		
enumeration	3																		
enumeration	4																		
enumeration	5																		
enumeration	6																		
enumeration	9																		

element **Intervento_Risparmio_Energetico_Type/Spesa**

diagram					
namespace	urn:www.agenziaentrate.gov.it:specificheTecniche:sco:730				
type	DatoNP Type				
facets	<table border="1"> <thead> <tr> <th>Kind</th> <th>Value</th> </tr> </thead> <tbody> <tr> <td>pattern</td> <td>[1-9]{1}[0-9]*</td> </tr> </tbody> </table>	Kind	Value	pattern	[1-9]{1}[0-9]*
Kind	Value				
pattern	[1-9]{1}[0-9]*				

complexType **Iva_Acquisto_Abitazione_Type**

diagram	
namespace	urn:www.agenziaentrate.gov.it:specificheTecniche:sco:730
children	m730:NumeroRata m730:Importo

element **Iva_Acquisto_Abitazione_Type/NumeroRata**

diagram							
namespace	urn:www.agenziaentrate.gov.it:specificheTecniche:sco:730						
type	restriction of DatoNP Type						
facets	<table border="1"> <thead> <tr> <th>Kind</th> <th>Value</th> </tr> </thead> <tbody> <tr> <td>pattern</td> <td>[1-9]{1}[0-9]*</td> </tr> <tr> <td>enumeration</td> <td>1</td> </tr> </tbody> </table>	Kind	Value	pattern	[1-9]{1}[0-9]*	enumeration	1
Kind	Value						
pattern	[1-9]{1}[0-9]*						
enumeration	1						

element **Iva_Acquisto_Abitazione_Type/Importo**

diagram					
namespace	urn:www.agenziaentrate.gov.it:specificheTecniche:sco:730				
type	DatoNP_Type				
facets	<table border="1"> <tr> <th>Kind</th> <th>Value</th> </tr> <tr> <td>pattern</td> <td>[1-9]{1}[0-9]*</td> </tr> </table>	Kind	Value	pattern	[1-9]{1}[0-9]*
Kind	Value				
pattern	[1-9]{1}[0-9]*				

complexType **Lavoro_Dipendente_Type**

diagram	
namespace	urn:www.agenziaentrate.gov.it:specificheTecniche:sco:730
children	m730:TipologiaReddito m730:TipoContratto m730:Reddito

element **Lavoro_Dipendente_Type/TipologiaReddito**

diagram																	
namespace	urn:www.agenziaentrate.gov.it:specificheTecniche:sco:730																
type	restriction of DatoN1_Type																
facets	<table border="1"> <tr> <th>Kind</th> <th>Value</th> </tr> <tr> <td>pattern</td> <td>[1-9]</td> </tr> <tr> <td>enumeration</td> <td>1</td> </tr> <tr> <td>enumeration</td> <td>2</td> </tr> <tr> <td>enumeration</td> <td>3</td> </tr> <tr> <td>enumeration</td> <td>4</td> </tr> <tr> <td>enumeration</td> <td>5</td> </tr> <tr> <td>enumeration</td> <td>6</td> </tr> </table>	Kind	Value	pattern	[1-9]	enumeration	1	enumeration	2	enumeration	3	enumeration	4	enumeration	5	enumeration	6
Kind	Value																
pattern	[1-9]																
enumeration	1																
enumeration	2																
enumeration	3																
enumeration	4																
enumeration	5																
enumeration	6																

element **Lavoro_Dipendente_Type/TipoContratto**

diagram									
namespace	urn:www.agenziaentrate.gov.it:specificheTecniche:sco:730								
type	m730:Indeterminato_Determinato_Type								
facets	<table border="1"> <tr> <th>Kind</th> <th>Value</th> </tr> <tr> <td>pattern</td> <td>[1-9]</td> </tr> <tr> <td>enumeration</td> <td>1</td> </tr> <tr> <td>enumeration</td> <td>2</td> </tr> </table>	Kind	Value	pattern	[1-9]	enumeration	1	enumeration	2
Kind	Value								
pattern	[1-9]								
enumeration	1								
enumeration	2								

element **Lavoro_Dipendente_Type/Reddito**

diagram	
namespace	urn:www.agenziaentrate.gov.it:specificheTecniche:sco:730
type	DatoNP_Type
facets	Kind Value pattern [1-9]{1}[0-9]*

complexType **Misura_Acconti_Type**

diagram	
namespace	urn:www.agenziaentrate.gov.it:specificheTecniche:sco:730
children	m730:IrpefMisuralInferiore m730:AddComunaleMisuralInferiore m730:CedolareSeccaMisuralInferiore m730:NumeroRate

element **Misura_Acconti_Type/IrpefMisuralInferiore**

diagram	
namespace	urn:www.agenziaentrate.gov.it:specificheTecniche:sco:730
type	m730:Casella_Acconto_Type
children	m730:Casella m730:ImportoMisuralInferiore

element **Misura_Acconti_Type/AddComunaleMisuralInferiore**

diagram	
namespace	urn:www.agenziaentrate.gov.it:specificheTecniche:sco:730
type	m730:Casella_Acconto_Type

children	m730:Casella m730:ImportoMisuraInferiore
----------	--

element **Misura_Aconti_Type/CedolareSeccaMisuraInferiore**

diagram	
namespace	urn:www.agenziaentrate.gov.it:specificheTecniche:sco:730
type	m730:Casella_Aconto_Type
children	m730:Casella m730:ImportoMisuraInferiore

element **Misura_Aconti_Type/NumeroRate**

diagram																	
namespace	urn:www.agenziaentrate.gov.it:specificheTecniche:sco:730																
type	restriction of DatoN1_Type																
facets	<table border="1"> <thead> <tr> <th>Kind</th> <th>Value</th> </tr> </thead> <tbody> <tr> <td>pattern</td> <td>[1-9]</td> </tr> <tr> <td>enumeration</td> <td>2</td> </tr> <tr> <td>enumeration</td> <td>3</td> </tr> <tr> <td>enumeration</td> <td>4</td> </tr> <tr> <td>enumeration</td> <td>5</td> </tr> <tr> <td>enumeration</td> <td>6</td> </tr> <tr> <td>enumeration</td> <td>7</td> </tr> </tbody> </table>	Kind	Value	pattern	[1-9]	enumeration	2	enumeration	3	enumeration	4	enumeration	5	enumeration	6	enumeration	7
Kind	Value																
pattern	[1-9]																
enumeration	2																
enumeration	3																
enumeration	4																
enumeration	5																
enumeration	6																
enumeration	7																

complexType **Mod730_Integrativo_Type**

diagram	
namespace	urn:www.agenziaentrate.gov.it:specificheTecniche:sco:730
children	m730:ImportiRimborsare m730:ImportoRimborsato m730:ImportoRimborsatoAgenzia

element **Mod730_Integrativo_Type/ImportiRimborsare**

diagram	
namespace	urn:www.agenziaentrate.gov.it:specificheTecniche:sco:730
type	m730:Importi_Rimborsare_730-4_Integrativo_Type
children	m730:IrpefRimborsare m730:AddRegRimborsare m730:AddComRimborsare m730:CedolareRimborsare m730:TassazioneSepRimborsare m730:PremiRisultatoRimborsare m730:ContributoSolidarieta

element **Mod730_Integrativo_Type/ImportoRimborsato**

diagram					
namespace	urn:www.agenziaentrate.gov.it:specificheTecniche:sco:730				
type	DatoNP_Type				
facets	<table border="1"> <tr> <td>Kind</td> <td>Value</td> </tr> <tr> <td>pattern</td> <td>[1-9]{1}[0-9]*</td> </tr> </table>	Kind	Value	pattern	[1-9]{1}[0-9]*
Kind	Value				
pattern	[1-9]{1}[0-9]*				

element **Mod730_Integrativo_Type/ImportoRimborsatoAgenzia**

diagram					
namespace	urn:www.agenziaentrate.gov.it:specificheTecniche:sco:730				
type	DatoNP_Type				
facets	<table border="1"> <tr> <td>Kind</td> <td>Value</td> </tr> <tr> <td>pattern</td> <td>[1-9]{1}[0-9]*</td> </tr> </table>	Kind	Value	pattern	[1-9]{1}[0-9]*
Kind	Value				
pattern	[1-9]{1}[0-9]*				

complexType **Modulo_Altri_Reddito_Type**

diagram	
---------	--

namespace	urn:www.agenziaentrate.gov.it:specificheTecniche:sco:730
children	m730:RedditiDiCapitale m730:RedditiTassazioneSeparata

element **Modulo_Altri_Redditi_Type/RedditiDiCapitale**

diagram	
namespace	urn:www.agenziaentrate.gov.it:specificheTecniche:sco:730
type	m730:Redditi Capitale Type
children	m730:Utili m730:AltriRedditiDiCapitale m730:LavoroAutonomo m730:RedditiDiversi m730:RedditiDiversiDetraz

element **Modulo_Altri_Redditi_Type/RedditiTassazioneSeparata**

diagram	
namespace	urn:www.agenziaentrate.gov.it:specificheTecniche:sco:730
type	m730:Redditi Tassazione Separata Type
children	m730:RedditiErede m730:ImposteRimborsate

complexType **Modulo_Annotazioni_Type**

diagram	
namespace	urn:www.agenziaentrate.gov.it:specificheTecniche:sco:730
children	m730:Annotazione

element **Modulo_Anotazioni_Type/Annotazione**

diagram	
namespace	urn:www.agenziaentrate.gov.it:specificheTecniche:sco:730
type	m730:Annotazione_Type
children	m730:Codice m730:RigoQuadro m730:ModuloQuadro m730:Importo

complexType **Modulo_Comunicazione_Type**

diagram	
namespace	urn:www.agenziaentrate.gov.it:specificheTecniche:sco:730
children	m730:DatiCondominio m730:DatiCatastali m730:DomandaAccatastamento m730:DatiFornitore

element **Modulo_Comunicazione_Type/DatiCondominio**

diagram	
namespace	urn:www.agenziaentrate.gov.it:specificheTecniche:sco:730
type	m730:Dati_Condominio_Type
children	m730:CodiceFiscale m730:Denominazione

element **Modulo_Communicazione_Type/DatiCatastali**

diagram	
namespace	urn:www.agenziaentrate.gov.it:specificheTecniche:sco:730
type	m730:Dati_Catastali_Type
children	m730:CodiceComune m730:TerreniUrbano m730:SezioneUrbanaComuneCatastale m730:Foglio m730:Particella m730:Subalterno

element **Modulo_Communicazione_Type/DomandaAccatastamento**

diagram	
namespace	urn:www.agenziaentrate.gov.it:specificheTecniche:sco:730
type	m730:Domanda_Accatastamento_Type
children	m730:Data m730:Numero m730:ProvinciaUfficio

element **Modulo_Comunicazione_Type/DatiFornitore**

<p>diagram</p>	
<p>namespace</p>	<p>urn:www.agenziaentrate.gov.it:specificheTecniche:sco:730</p>
<p>type</p>	<p>m730:Dati Fornitore Type</p>
<p>children</p>	<p>m730:CodiceFiscale m730:CognomeDenom m730:Nome m730:Sesso m730:DataNascita m730:ComuneNascita m730:ProvinciaNascita m730:ImportoAcquisti</p>

complexType **Modulo_Crediti_Imposta_Type**

<p>diagram</p>	
<p>namespace</p>	<p>urn:www.agenziaentrate.gov.it:specificheTecniche:sco:730</p>
<p>children</p>	<p>m730:CreditoImpostaFondiPensione m730:CreditoImpostaRedditiEsteri m730:CreditoPrimaCasaSismaAbruzzo m730:CreditoAltriSismaAbruzzo m730:CreditoNegoziazione</p>

element **Modulo_Crediti_Imposta_Type/CreditiImpostaFondiPensione**

diagram	
namespace	urn:www.agenziaentrate.gov.it:specificheTecniche:sco:730
type	m730:Crediti_Imposta_Fondi_Pensione_Type
children	m730:AnnoAnticipazione m730:Reintegro m730:SommaReintegrata m730:CreditoAnno

element **Modulo_Crediti_Imposta_Type/CreditiImpostaRedditiEsteri**

diagram	
namespace	urn:www.agenziaentrate.gov.it:specificheTecniche:sco:730
type	m730:Crediti_Imposta_Redditi_Esteri_Type
children	m730:StatoEstero m730:Anno m730:RedditoEstero m730:ImpostaEstera m730:RedditoComplessivo m730:Imposta_Lorda m730:ImpostaNetta m730:CreditoDichiarazioniPrecedenti m730:DiCuiStatoEstero

element **Modulo_Crediti_Imposta_Type/CreditoPrimaCasaSismaAbruzzo**

diagram	
namespace	urn:www.agenziaentrate.gov.it:specificheTecniche:sco:730
type	m730:Credito_Immibile_Sisma_Abruzzo_Type
children	m730:CodiceFiscale m730:NumeroRata m730:TotaleCredito

element **Modulo_Crediti_Imposta_Type/CreditoAltriSismaAbruzzo**

diagram	
namespace	urn:www.agenziaentrate.gov.it:specificheTecniche:sco:730
type	m730:Crediti_Imposta_Altri_Sisma_Abruzzo_Type
children	m730:Impresa_Professione m730:CreditoImmibileSismaAbruzzo m730:Rateazione

element **Modulo_Crediti_Imposta_Type/CreditoNegoziazione**

diagram	
namespace	urn:www.agenziaentrate.gov.it:specificheTecniche:sco:730
type	m730:Modulo_Credito_Negoziatore_Type
children	m730:CreditoSpettante

complexType **Modulo_Credito_Negoziatore_Type**

diagram	
namespace	urn:www.agenziaentrate.gov.it:specificheTecniche:sco:730

children	m730:CreditoSpettante
----------	---------------------------------------

element **Modulo_Credito_Negoziatore_Type/CreditoSpettante**

diagram					
namespace	urn:www.agenziaentrate.gov.it:specificheTecniche:sco:730				
type	DatoNP_Type				
facets	<table border="1"> <thead> <tr> <th>Kind</th> <th>Value</th> </tr> </thead> <tbody> <tr> <td>pattern</td> <td>[1-9]{1}[0-9]*</td> </tr> </tbody> </table>	Kind	Value	pattern	[1-9]{1}[0-9]*
Kind	Value				
pattern	[1-9]{1}[0-9]*				

complexType **Modulo_Fabbricato_Type**

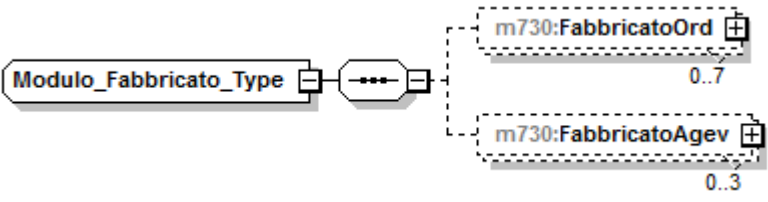
diagram	
namespace	urn:www.agenziaentrate.gov.it:specificheTecniche:sco:730
children	m730:FabbricatoOrd m730:FabbricatoAgev

element **Modulo_Fabbricato_Type/FabbricatoOrd**

<p>diagram</p>	
<p>namespace</p>	<p>urn:www.agenziaentrate.gov.it:specificheTecniche:sco:730</p>
<p>type</p>	<p>m730:Fabbricato_Ord_Type</p>
<p>children</p>	<p>m730:Rendita m730:Utilizzo m730:GiorniPossesso m730:PercPossesso m730:CodiceCanone m730:CanoneLocazione m730:CasiParticolari m730:CasellaContinuazione m730:CodiceComune m730:OpzioneCedolare m730:CasellaCasiPartimu</p>

element **Modulo_Fabbricato_Type/FabbricatoAgev**

<p>diagram</p>	
<p>namespace</p>	<p>urn:www.agenziaentrate.gov.it:specificheTecniche:sco:730</p>

type	m730:Fabbricato_Agev_Type
children	m730:NumeroRigoRiferimento m730:NumModuloRiferimento m730:DatiContratto m730:CasellaInf30Giorni m730:AnnoDichiarazioneIcilmu m730:StatoEmergenza

complexType **Modulo_Familiari_Type**

diagram	
namespace	urn:www.agenziaentrate.gov.it:specificheTecniche:sco:730
children	m730:Coniuge m730:PrimoFiglio m730:Familiari

element **Modulo_Familiari_Type/Coniuge**

diagram	
namespace	urn:www.agenziaentrate.gov.it:specificheTecniche:sco:730
type	m730:Dati_Coniuge_Type
children	m730:Tipo m730:CodiceFiscale m730:Mesi

element **Modulo_Familiari_Type/PrimoFiglio**

diagram	<p>The diagram illustrates the class m730:PrimoFiglio as an extension of m730:Dati_Familiare_Type. The extension is highlighted in a yellow dashed box and includes the following elements: m730:CodiceFiscale, m730:Mesi, m730:MesiMinore, m730:PercDetraz, m730:PercDetrazCon, m730:Affidamento, and m730:Tipo. The m730:PercDetraz and m730:PercDetrazCon elements are shown as a pair within a dashed box, indicating a relationship between them.</p>
namespace	urn:www.agenziaentrate.gov.it:specificheTecniche:sco:730
type	extension of m730:Dati_Familiare_Type
children	m730:CodiceFiscale m730:Mesi m730:MesiMinore m730:PercDetraz m730:PercDetrazCon m730:Affidamento m730:Tipo

element **Modulo_Familiari_Type/PrimoFiglio/Tipo**

diagram	<p>The diagram shows the class m730:Tipo as a restriction of DatoAN_Type.</p>								
namespace	urn:www.agenziaentrate.gov.it:specificheTecniche:sco:730								
type	restriction of DatoAN_Type								
facets	<table border="1"> <thead> <tr> <th>Kind</th> <th>Value</th> </tr> </thead> <tbody> <tr> <td>pattern</td> <td>(([0-9A-Z-] &quot;){1}([0-9A-Z&amp;:] ' - \- . \./ ° °\°\(\)\ À É È Ì Ò Ù Û &quot; \N \+)*</td> </tr> <tr> <td>enumeration</td> <td>F</td> </tr> <tr> <td>enumeration</td> <td>D</td> </tr> </tbody> </table>	Kind	Value	pattern	(([0-9A-Z-] "){1}([0-9A-Z&:] ' - \- . \./ ° °\°\(\)\ À É È Ì Ò Ù Û " \N \+)*	enumeration	F	enumeration	D
Kind	Value								
pattern	(([0-9A-Z-] "){1}([0-9A-Z&:] ' - \- . \./ ° °\°\(\)\ À É È Ì Ò Ù Û " \N \+)*								
enumeration	F								
enumeration	D								

element **Modulo_Familiari_Type/Familiari**

diagram	
namespace	urn:www.agenziaentrate.gov.it:specificheTecniche:sco:730
type	extension of m730:Dati_Familiare_Type
children	m730:CodiceFiscale m730:Mesi m730:MesiMinore m730:PercDetraz m730:PercDetrazCon m730:Affidamento m730:Tipo

element **Modulo_Familiari_Type/Familiari/Tipo**

diagram											
namespace	urn:www.agenziaentrate.gov.it:specificheTecniche:sco:730										
type	restriction of DatoAN_Type										
facets	<table border="0"> <thead> <tr> <th>Kind</th> <th>Value</th> </tr> </thead> <tbody> <tr> <td>pattern</td> <td>(([0-9A-Z-] &quot;){1}([0-9A-Z&amp;:] ' - \- . \./ ° \\ \\(\\) À É È Ì Ò Ù Û &quot; \\N \\+)*</td> </tr> <tr> <td>enumeration</td> <td>F</td> </tr> <tr> <td>enumeration</td> <td>D</td> </tr> <tr> <td>enumeration</td> <td>A</td> </tr> </tbody> </table>	Kind	Value	pattern	(([0-9A-Z-] "){1}([0-9A-Z&:] ' - \- . \./ ° \\ \\(\\) À É È Ì Ò Ù Û " \\N \\+)*	enumeration	F	enumeration	D	enumeration	A
Kind	Value										
pattern	(([0-9A-Z-] "){1}([0-9A-Z&:] ' - \- . \./ ° \\ \\(\\) À É È Ì Ò Ù Û " \\N \\+)*										
enumeration	F										
enumeration	D										
enumeration	A										

complexType **Modulo_Lavoro_Dip_Type**

diagram	
namespace	urn:www.agenziaentrate.gov.it:specificheTecniche:sco:730

children	m730:LavoroDipendente m730:PremiRisultato m730:AltriRedditiAssLavDip m730:BonusIrfp
----------	---

element **Modulo_Lavoro_Dip_Type/LavoroDipendente**

diagram	
namespace	urn:www.agenziaentrate.gov.it:specificheTecniche:sco:730
type	m730:Lavoro_Dipendente_Type
children	m730:TipologiaReddito m730:TipoContratto m730:Reddito

element **Modulo_Lavoro_Dip_Type/PremiRisultato**

diagram	
namespace	urn:www.agenziaentrate.gov.it:specificheTecniche:sco:730
type	m730:Premi_Risultato_Modulo_Type
children	m730:TipoLimite m730:ImportoTassazOrdinaria m730:ImportoImpostaSostitutiva m730:RitenuteImpostaSostitutiva m730:Benefit

element **Modulo_Lavoro_Dip_Type/AltriRedditiAssLavDip**

diagram	
namespace	urn:www.agenziaentrate.gov.it:specificheTecniche:sco:730

type	m730:Altri Redditi Ass Lav Type
children	m730:AssegnoDelConiuge m730:ImportoRedditoAssimilato

element **Modulo_Lavoro_Dip_Type/BonusIrpef**

diagram	
namespace	urn:www.agenziaentrate.gov.it:specificheTecniche:sco:730
children	m730:Esenzione

element **Modulo_Lavoro_Dip_Type/BonusIrpef/Esenzione**

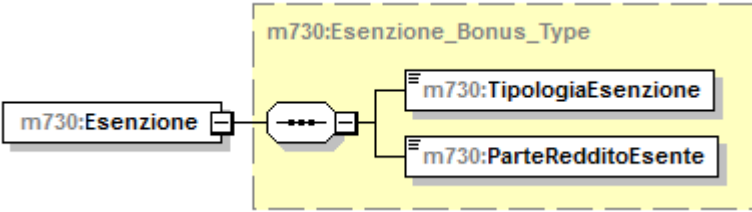
diagram	
namespace	urn:www.agenziaentrate.gov.it:specificheTecniche:sco:730
type	m730:Esenzione Bonus Type
children	m730:TipologiaEsenzione m730:ParteRedditoEsente

complexType **Modulo_Oneri_Type**

<p>diagram</p>	
<p>namespace</p>	<p>urn:www.agenziaentrate.gov.it:specificheTecniche:sco:730</p>
<p>children</p>	<p>m730:SpeseDetrazioni m730:SpeseDeduzioni m730:InterventoRecuperoPatrimonioEdilizio m730:DatiCatastaliRecuperoPatrimonioEdilizio m730:InterventoRisparmioEnergetico m730:CanoniLocazione m730:DatiAltreDetrazioni m730:SpeseArredo m730:SpeseArredoGiovaniCoppie m730:IvaAcquistoAbitazione</p>

element **Modulo_Oneri_Type/SpeseDetrazioni**

<p>diagram</p>	
<p>namespace</p>	<p>urn:www.agenziaentrate.gov.it:specificheTecniche:sco:730</p>
<p>type</p>	<p>m730:Detrazioni Modulo Type</p>
<p>children</p>	<p>m730:VeicoliDisabili m730:AcquistoCaniGuida m730:SpeseRateizzate m730:AltreSpese m730:SpeseLeasing</p>

element **Modulo_Oneri_Type/SpeseDeduzioni**

diagram	<p>The diagram shows a class <code>m730:SpeseDeduzioni</code> on the left, connected by a solid line to a composition symbol (a circle with three dots). This symbol is connected to three child classes: <code>m730:AssegnoConiuge</code>, <code>m730:AltriOneri</code>, and <code>m730:AcquistoCostruzioneAbit...</code>. All these classes are enclosed in a dashed box labeled <code>m730:Deduzioni_Modulo_Type</code>.</p>
namespace	urn:www.agenziaentrate.gov.it:specificheTecniche:sco:730
type	m730:Deduzioni_Modulo_Type
children	m730:AssegnoConiuge m730:AltriOneri m730:AcquistoCostruzioneAbitLocazione

element **Modulo_Oneri_Type/InterventoRecuperoPatrimonioEdilizio**

diagram	<p>The diagram shows a class <code>m730:InterventoRecuperoPatri...</code> on the left, connected by a solid line to a composition symbol (a circle with three dots). This symbol is connected to eight child classes: <code>m730:Anno</code>, <code>m730:Periodo</code>, <code>m730:CodiceFiscale</code>, <code>m730:CasellaInterventiParticolari</code>, <code>m730:Codice SituazioniParticolari</code>, <code>m730:Rate10</code>, <code>m730:Spesa</code>, and <code>m730:NOrdineImmobile</code>. All these classes are enclosed in a dashed box labeled <code>m730:Intervento_Recupero_Patrimonio_Edilizio_Type</code>. The number <code>0..3</code> is written below the composition line.</p>
namespace	urn:www.agenziaentrate.gov.it:specificheTecniche:sco:730
type	m730:Intervento_Recupero_Patrimonio_Edilizio_Type
children	m730:Anno m730:Periodo m730:CodiceFiscale m730:CasellaInterventiParticolari m730:CodiceSituazioniParticolari m730:Rate10 m730:Spesa m730:NOrdineImmobile

element **Modulo_Oneri_Type/DatiCatastaliRecuperoPatrimonioEdilizio**

diagram	
namespace	urn:www.agenziaentrate.gov.it:specificheTecniche:sco:730
type	m730:Sezione Dati Catastali Recupero Patrimonio Edilizio Type
children	m730:DatiCatastaliRecuperoPatrimonioEdilizio m730:DatiRegistrazioneAccatastamentoRecuperoPatrimonio Edilizio

element **Modulo_Oneri_Type/InterventoRisparmioEnergetico**

diagram	
namespace	urn:www.agenziaentrate.gov.it:specificheTecniche:sco:730
type	m730:Intervento Risparmio Energetico Type
children	m730:TipoIntervento m730:Anno m730:Periodo2013 m730:CasiParticolari m730:RideterminazioneRate m730:RipartizioneRate m730:NumeroRata m730:Spesa

element **Modulo_Oneri_Type/CanoniLocazione**

diagram	
---------	--

namespace	urn:www.agenziaentrate.gov.it:specificheTecniche:sco:730
type	m730:Detrazioni Canoni Locazione Type
children	m730:InquiliniAbitazionePrincipale m730:DipendentiTrasferiti

element **Modulo_Oneri_Type/DatiAltreDetrazioni**

diagram	
namespace	urn:www.agenziaentrate.gov.it:specificheTecniche:sco:730
type	m730:Dati Altre Detrazioni Modulo Type
children	m730:AltreDetrazioni

element **Modulo_Oneri_Type/SpeseArredo**

diagram	
namespace	urn:www.agenziaentrate.gov.it:specificheTecniche:sco:730
type	m730:Spese Arredo Type
children	m730:NumeroRata m730:Importo

element **Modulo_Oneri_Type/SpeseArredoGiovaniCoppie**

diagram	
namespace	urn:www.agenziaentrate.gov.it:specificheTecniche:sco:730
type	m730:Spese Arredo Giovani Coppie Type
children	m730:Meno35Anni m730:NumeroRata m730:Importo

element **Modulo_Oneri_Type/IvaAcquistoAbitazione**

diagram	
namespace	urn:www.agenziaentrate.gov.it:specificheTecniche:sco:730
type	m730:Iva_Acquisto_Abitazione_Type
children	m730:NumeroRata m730:Importo

complexType **Modulo_PL_Type**

diagram	
namespace	urn:www.agenziaentrate.gov.it:specificheTecniche:sco:730
children	m730:CredImpEsteri

element **Modulo_PL_Type/CredImpEsteri**

diagram	
namespace	urn:www.agenziaentrate.gov.it:specificheTecniche:sco:730
type	m730:Cred_Imp_Esteri_Type
children	m730:Anno m730:TotCredito m730:CreditoStato

complexType **Modulo_Terreno_Type**

diagram	
namespace	urn:www.agenziaentrate.gov.it:specificheTecniche:sco:730
children	m730:Terreno

element **Modulo_Terreno_Type/Terreno**

<p>diagram</p>	<p>The diagram illustrates the structure of the m730:Terreno_Type element. It is a complex type containing several child elements, each represented by a dashed box. The elements are:</p> <ul style="list-style-type: none"> m730:RedDominicale m730:Titolo m730:RedAgrario m730:GiorniPossesso m730:PercPossesso m730:CanoneVincolistico m730:CasiParticolari m730:CasellaContinuazione m730:CasellalmuNonDovuta m730:CasellaColtivatoreDiretto <p>The m730:Terreno_Type element is connected to the m730:Terreno element via a composition relationship, indicated by a solid line with an open arrowhead pointing to m730:Terreno_Type. The multiplicity of m730:Terreno is 1..6.</p>
<p>namespace</p>	<p>urn:www.agenziaentrate.gov.it:specificheTecniche:sco:730</p>
<p>type</p>	<p>m730:Terreno_Type</p>
<p>children</p>	<p>m730:RedDominicale m730:Titolo m730:RedAgrario m730:GiorniPossesso m730:PercPossesso m730:CanoneVincolistico m730:CasiParticolari m730:CasellaContinuazione m730:CasellalmuNonDovuta m730:CasellaColtivatoreDiretto</p>

complexType Oneri_Non_Abbattuti_Type

diagram	
namespace	urn:www.agenziaentrate.gov.it:specificheTecniche:sco:730
children	m730:DetrazSpeseAssPersonale m730:DetrazErogazBiennaleVenezia m730:DetrazErogazSpettacolo m730:DetrazErogazSettoreMusicale m730:DeduzContributiPaesiSviluppo m730:DeduzOnlus m730:DetrazOspedaleGalliera m730:PrevidenzaCompIDipPubblici m730:InteressiMutuiAgrari m730:DeduzTrust

element Oneri_Non_Abbattuti_Type/DetrazSpeseAssPersonale

diagram					
namespace	urn:www.agenziaentrate.gov.it:specificheTecniche:sco:730				
type	DatoNP_Type				
facets	<table border="1"> <thead> <tr> <th>Kind</th> <th>Value</th> </tr> </thead> <tbody> <tr> <td>pattern</td> <td>[1-9]{1}[0-9]*</td> </tr> </tbody> </table>	Kind	Value	pattern	[1-9]{1}[0-9]*
Kind	Value				
pattern	[1-9]{1}[0-9]*				

element Oneri_Non_Abbattuti_Type/DetrazErogazBiennaleVenezia

diagram					
namespace	urn:www.agenziaentrate.gov.it:specificheTecniche:sco:730				
type	DatoNP_Type				
facets	<table border="1"> <thead> <tr> <th>Kind</th> <th>Value</th> </tr> </thead> <tbody> <tr> <td>pattern</td> <td>[1-9]{1}[0-9]*</td> </tr> </tbody> </table>	Kind	Value	pattern	[1-9]{1}[0-9]*
Kind	Value				
pattern	[1-9]{1}[0-9]*				

element **Oneri_Non_Abbattuti_Type/DetrazErogazSpettacolo**

diagram	 m730:DetrazErogazSpettacolo
namespace	urn:www.agenziaentrate.gov.it:specificheTecniche:sco:730
type	DatoNP_Type
facets	Kind Value pattern [1-9]{1}[0-9]*

element **Oneri_Non_Abbattuti_Type/DetrazErogazSettoreMusicale**

diagram	 m730:DetrazErogazSettoreMus...
namespace	urn:www.agenziaentrate.gov.it:specificheTecniche:sco:730
type	DatoNP_Type
facets	Kind Value pattern [1-9]{1}[0-9]*

element **Oneri_Non_Abbattuti_Type/DeduzContributiPaesiSviluppo**

diagram	 m730:DeduzContributiPaesiSvilu...
namespace	urn:www.agenziaentrate.gov.it:specificheTecniche:sco:730
type	DatoNP_Type
facets	Kind Value pattern [1-9]{1}[0-9]*

element **Oneri_Non_Abbattuti_Type/DeduzOnlus**

diagram	 m730:DeduzOnlus
namespace	urn:www.agenziaentrate.gov.it:specificheTecniche:sco:730
type	DatoNP_Type
facets	Kind Value pattern [1-9]{1}[0-9]*

element **Oneri_Non_Abbattuti_Type/DetrazOspedaleGalliera**

diagram	 m730:DetrazOspedaleGalliera
namespace	urn:www.agenziaentrate.gov.it:specificheTecniche:sco:730
type	DatoNP_Type
facets	Kind Value pattern [1-9]{1}[0-9]*

element Oneri_Non_Abbattuti_Type/PrevidenzaComplDipPubblici

diagram	
namespace	urn:www.agenziaentrate.gov.it:specificheTecniche:sco:730
type	DatoNP_Type
facets	Kind Value pattern [1-9]{1}[0-9]*

element Oneri_Non_Abbattuti_Type/InteressiMutuiAgrari

diagram	
namespace	urn:www.agenziaentrate.gov.it:specificheTecniche:sco:730
type	DatoNP_Type
facets	Kind Value pattern [1-9]{1}[0-9]*

element Oneri_Non_Abbattuti_Type/DeduzTrust

diagram	
namespace	urn:www.agenziaentrate.gov.it:specificheTecniche:sco:730
type	DatoNP_Type
facets	Kind Value pattern [1-9]{1}[0-9]*

complexType Oneri_Type

diagram	
namespace	urn:www.agenziaentrate.gov.it:specificheTecniche:sco:730
children	m730:PrimoModulo m730:Modulo

element **Oneri_Type/PrimoModulo**

<p>diagram</p>	
<p>namespace</p>	<p>urn:www.agenziaentrate.gov.it:specificheTecniche:sco:730</p>
<p>type</p>	<p>m730:Primo_Modulo_Oneri_Type</p>
<p>children</p>	<p>m730:SpeseDetrazioni m730:SpeseDeduzioni m730:InterventoRecuperoPatrimonioEdilizio m730:DatiCatastaliRecuperoPatrimonioEdilizio m730:InterventoRisparmioEnergetico m730:CanoniLocazione m730:DatiAltreDetrazioni m730:OneriNonAbbattuti m730:SpeseArredo m730:SpeseArredoGiovani m730:IvaAcquistoAbitazione</p>

element **Oneri_Type/Modulo**

<p>diagram</p>	
<p>namespace</p>	<p>urn:www.agenziaentrate.gov.it:specificheTecniche:sco:730</p>
<p>type</p>	<p>m730:Modulo_Oneri_Type</p>
<p>children</p>	<p>m730:SpeseDetrazioni m730:SpeseDeduzioni m730:InterventoRecuperoPatrimonioEdilizio m730:DatiCatastaliRecuperoPatrimonioEdilizio m730:InterventoRisparmioEnergetico m730:CanoniLocazione m730:DatiAltreDetrazioni m730:SpeseArredo m730:SpeseArredoGiovaniCoppie m730:IvaAcquistoAbitazione</p>

complexType **Opzione_Produttivita_Type**

<p>diagram</p>	
<p>namespace</p>	<p>urn:www.agenziaentrate.gov.it:specificheTecniche:sco:730</p>

complexType **Periodo_Di_Lavoro_Type**

<p>diagram</p>	
<p>namespace</p>	<p>urn:www.agenziaentrate.gov.it:specificheTecniche:sco:730</p>
<p>children</p>	<p>m730:GiorniLavoroDipendente m730:GiorniPensione</p>

element **Periodo_Di_Lavoro_Type/GiorniLavoroDipendente**

diagram					
namespace	urn:www.agenziaentrate.gov.it:specificheTecniche:sco:730				
type	DatoGA_Type				
facets	<table border="1"> <thead> <tr> <th>Kind</th> <th>Value</th> </tr> </thead> <tbody> <tr> <td>pattern</td> <td>[1-9]((1-9)[0-9])((12)[0-9][0-9])(3[0-5][0-9])(36[0-5])</td> </tr> </tbody> </table>	Kind	Value	pattern	[1-9]((1-9)[0-9])((12)[0-9][0-9])(3[0-5][0-9])(36[0-5])
Kind	Value				
pattern	[1-9]((1-9)[0-9])((12)[0-9][0-9])(3[0-5][0-9])(36[0-5])				

element **Periodo_Di_Lavoro_Type/GiorniPensione**

diagram					
namespace	urn:www.agenziaentrate.gov.it:specificheTecniche:sco:730				
type	DatoGA_Type				
facets	<table border="1"> <thead> <tr> <th>Kind</th> <th>Value</th> </tr> </thead> <tbody> <tr> <td>pattern</td> <td>[1-9]((1-9)[0-9])((12)[0-9][0-9])(3[0-5][0-9])(36[0-5])</td> </tr> </tbody> </table>	Kind	Value	pattern	[1-9]((1-9)[0-9])((12)[0-9][0-9])(3[0-5][0-9])(36[0-5])
Kind	Value				
pattern	[1-9]((1-9)[0-9])((12)[0-9][0-9])(3[0-5][0-9])(36[0-5])				

complexType **Pignoramento_Type**

diagram	
namespace	urn:www.agenziaentrate.gov.it:specificheTecniche:sco:730
children	m730:TipoRedditoPignoramento m730:RitenutePignoramento

element **Pignoramento_Type/TipoRedditoPignoramento**

diagram																	
namespace	urn:www.agenziaentrate.gov.it:specificheTecniche:sco:730																
type	restriction of DatoN1_Type																
facets	<table border="1"> <thead> <tr> <th>Kind</th> <th>Value</th> </tr> </thead> <tbody> <tr> <td>pattern</td> <td>[1-9]</td> </tr> <tr> <td>enumeration</td> <td>1</td> </tr> <tr> <td>enumeration</td> <td>2</td> </tr> <tr> <td>enumeration</td> <td>3</td> </tr> <tr> <td>enumeration</td> <td>4</td> </tr> <tr> <td>enumeration</td> <td>5</td> </tr> <tr> <td>enumeration</td> <td>6</td> </tr> </tbody> </table>	Kind	Value	pattern	[1-9]	enumeration	1	enumeration	2	enumeration	3	enumeration	4	enumeration	5	enumeration	6
Kind	Value																
pattern	[1-9]																
enumeration	1																
enumeration	2																
enumeration	3																
enumeration	4																
enumeration	5																
enumeration	6																

element **Pignoramento_Type/RitenutePignoramento**

diagram	
---------	--

namespace	urn:www.agenziaentrate.gov.it:specificheTecniche:sco:730
type	DatoNP_Type
facets	Kind Value pattern [1-9]{1}[0-9]*

complexType Premi_Risultato_Modulo_Type

diagram	
namespace	urn:www.agenziaentrate.gov.it:specificheTecniche:sco:730
children	m730:TipoLimite m730:ImportoTassazOrdinaria m730:ImportoImpostaSostitutiva m730:RitenuteImpostaSostitutiva m730:Benefit

element Premi_Risultato_Modulo_Type/TipoLimite

diagram	
namespace	urn:www.agenziaentrate.gov.it:specificheTecniche:sco:730
type	restriction of DatoN1_Type
facets	Kind Value pattern [1-9] enumeration 1 enumeration 2

element Premi_Risultato_Modulo_Type/ImportoTassazOrdinaria

diagram	
namespace	urn:www.agenziaentrate.gov.it:specificheTecniche:sco:730
type	DatoNP_Type
facets	Kind Value pattern [1-9]{1}[0-9]*

element Premi_Risultato_Modulo_Type/ImportoImpostaSostitutiva

diagram	
namespace	urn:www.agenziaentrate.gov.it:specificheTecniche:sco:730

type	DatoNP_Type
facets	Kind Value pattern [1-9]{1}[0-9]*

element **Premi_Risultato_Modulo_Type/RitenuteImpostaSostitutiva**

diagram	
namespace	urn:www.agenziaentrate.gov.it:specificheTecniche:sco:730
type	DatoNP_Type
facets	Kind Value pattern [1-9]{1}[0-9]*

element **Premi_Risultato_Modulo_Type/Benefit**

diagram	
namespace	urn:www.agenziaentrate.gov.it:specificheTecniche:sco:730
type	DatoNP_Type
facets	Kind Value pattern [1-9]{1}[0-9]*

complexType **Premi_Risultato_Type**

diagram	
namespace	urn:www.agenziaentrate.gov.it:specificheTecniche:sco:730
type	extension of m730:Premi_Risultato_Modulo_Type
children	m730:TipoLimite m730:ImportoTassazOrdinaria m730:ImportoImpostaSostitutiva m730:RitenuteImpostaSostitutiva m730:Benefit m730:TassazOrdinaria m730:TassazSostitutiva

element **Premi_Risultato_Type/TassazOrdinaria**

diagram	
namespace	urn:www.agenziaentrate.gov.it:specificheTecniche:sco:730
type	DatoCB_Type
facets	Kind Value pattern [01]

element **Premi_Risultato_Type/TassazSostitutiva**

diagram	
namespace	urn:www.agenziaentrate.gov.it:specificheTecniche:sco:730
type	DatoCB_Type
facets	Kind Value pattern [01]

complexType **Primo_Modulo_Acconti_Ritenute_Type**

diagram	
namespace	urn:www.agenziaentrate.gov.it:specificheTecniche:sco:730
children	m730:Accontilrpef m730:AltreRitenute m730:Eccedenze m730:EccedenzeOltreAnno m730:RitenuteAccontiSospesi m730:MisuraAcconti m730:EsenzioneAddComunale m730:Dati730Integrativo m730:AccontiAltriDati

element **Primo_Modulo_Acconti_Ritenute_Type/Accontilrpef**

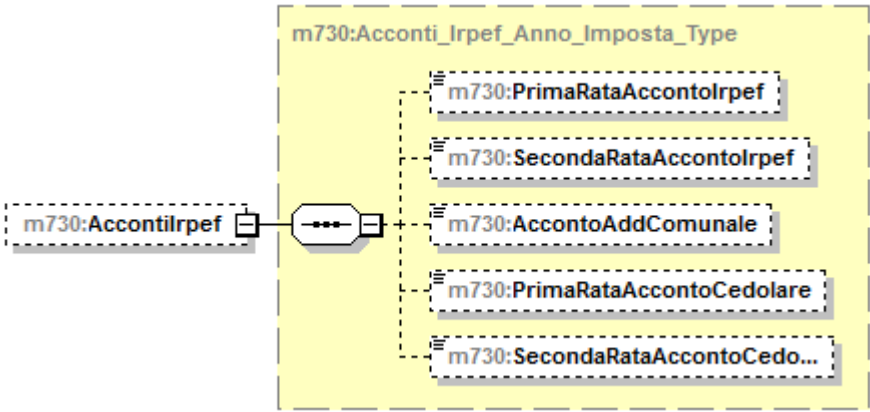
diagram	
namespace	urn:www.agenziaentrate.gov.it:specificheTecniche:sco:730
type	m730:Acconti_Irpef_Anno_Imposta_Type
children	m730:PrimaRataAccontolrpef m730:SecondaRataAccontolrpef m730:AccontoAddComunale m730:PrimaRataAccontoCedolare m730:SecondaRataAccontoCedolare

element **Primo_Modulo_Acconti_Ritenute_Type/AltreRitenute**

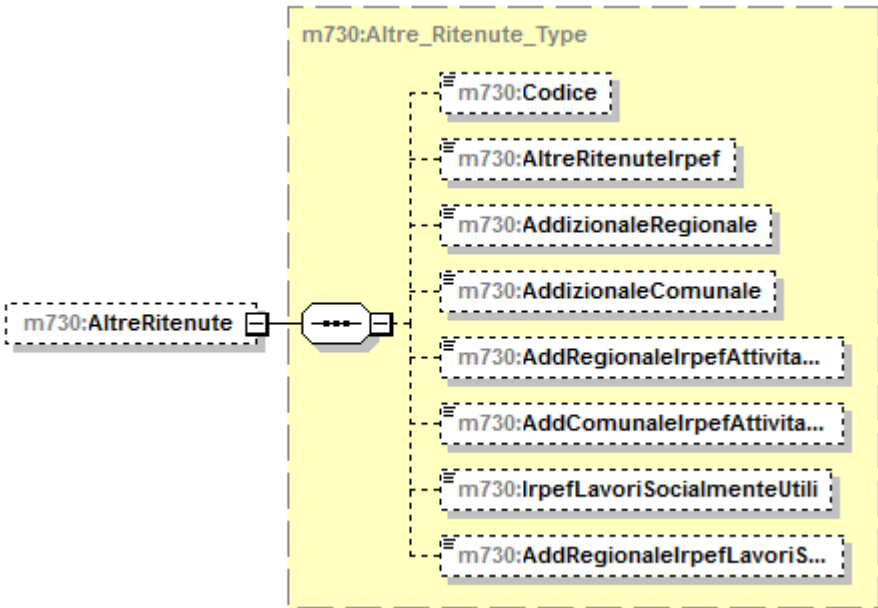
diagram	
namespace	urn:www.agenziaentrate.gov.it:specificheTecniche:sco:730
type	m730:Altre_Ritenute_Type
children	m730:Codice m730:AltreRitenuteIrpef m730:AddizionaleRegionale m730:AddizionaleComunale m730:AddRegionaleIrpefAttivitaSport m730:AddComunaleIrpefAttivitaSport m730:IrpefLavoriSocialmenteUtili m730:AddRegionaleIrpefLavoriSoc Utili

element **Primo_Modulo_Acconti_Ritenute_Type/Eccedenze**

<p>diagram</p>	
<p>namespace</p>	<p>urn:www.agenziaentrate.gov.it:specificheTecniche:sco:730</p>
<p>type</p>	<p>m730:Eccedenze_Type</p>
<p>children</p>	<p>m730:Irpef m730:IrpefCompF24 m730:SostitutivaQuadroRT m730:SostitutivaQuadroRTcompF24 m730:CedolareSecca m730:CedolareSeccaCompF24 m730:CodiceRegione m730:AddRegionaleIrpef m730:AddRegionaleIrpefCompF24 m730:CodiceCatastaleComune m730:AddComunaleIrpef m730:AddComunaleIrpefF24</p>

element **Primo_Modulo_Acconti_Ritenute_Type/EccedenzeOltreAnno**

<p>diagram</p>	
<p>namespace</p>	<p>urn:www.agenziaentrate.gov.it:specificheTecniche:sco:730</p>
<p>type</p>	<p>m730:Eccedenze Oltre Anno Type</p>
<p>children</p>	<p>m730:Anno m730:Irpef m730:SostitutivaQuadroRT m730:CedolareSecca m730:CodiceRegione m730:AddRegionaleIrpef m730:CodiceCatastaleComune m730:AddComunaleIrpef m730:ImpostaSostitutiva</p>

element **Primo_Modulo_Acconti_Ritenute_Type/RitenuteAccontiSospesi**

<p>diagram</p>	
<p>namespace</p>	<p>urn:www.agenziaentrate.gov.it:specificheTecniche:sco:730</p>
<p>type</p>	<p>m730:Ritenute Acconti Sospesi Type</p>
<p>children</p>	<p>m730:CodiceEvento m730:Irpef m730:AddRegionaleIrpef m730:AddComunaleIrpef m730:SostitutivaPremi</p>

[m730:CedolareSecca](#) [m730:ContribSolidarieta](#)

element **Primo_Modulo_Acconti_Ritenute_Type/MisuraAcconti**

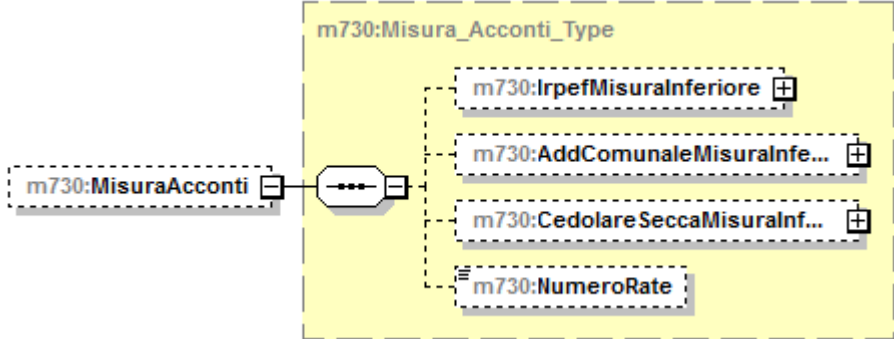
diagram	
namespace	urn:www.agenziaentrate.gov.it:specificheTecniche:sco:730
type	m730:Misura_Acconti_Type
children	m730:IrpefMisuralInferiore m730:AddComunaleMisuralInferiore m730:CedolareSeccaMisuralInferiore m730:NumeroRate

element **Primo_Modulo_Acconti_Ritenute_Type/EsenzioneAddComunale**

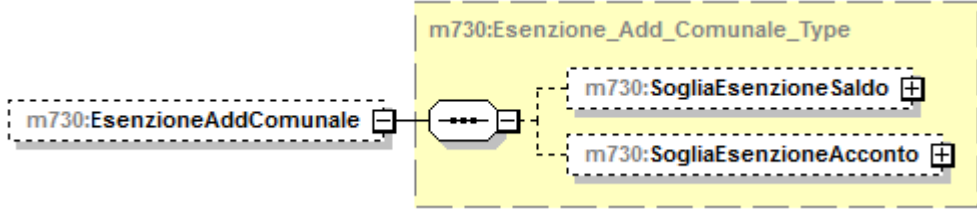
diagram	
namespace	urn:www.agenziaentrate.gov.it:specificheTecniche:sco:730
type	m730:Esenzione_Add_Comunale_Type
children	m730:SogliaEsenzioneSaldo m730:SogliaEsenzioneAcconto

element **Primo_Modulo_Acconti_Ritenute_Type/Dati730Integrativo**

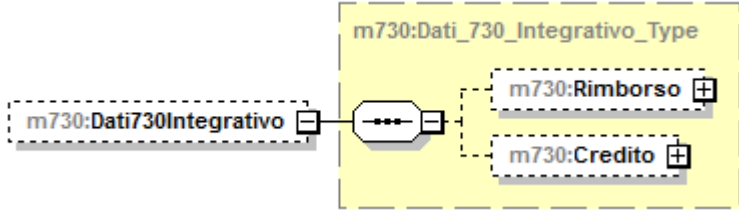
diagram	
namespace	urn:www.agenziaentrate.gov.it:specificheTecniche:sco:730
type	m730:Dati_730_Integrativo_Type
children	m730:Rimborso m730:Credito

element **Primo Modulo Acconti Ritenute Type/AccontiAltriDati**

diagram	
namespace	urn:www.agenziaentrate.gov.it:specificheTecniche:sco:730
type	m730:Acconti_Altri_Dati_Type
children	m730:IncapientiDetrazioneFigli m730:IncapientiDetrazioneLocazione m730:RestituzioneBonusFiscale m730:RestituzioneBonusStraordinario m730:Pignoramento

complexType **Primo Modulo Crediti Imposta Type**

diagram	
namespace	urn:www.agenziaentrate.gov.it:specificheTecniche:sco:730
children	m730:CreditoImpostaFabbricati m730:CreditoImpostaFondiPensione m730:CreditoImpostaRedditiEsteri m730:CreditoPrimaCasaSismaAbruzzo m730:CreditoAltriSismaAbruzzo m730:CreditoIncrementoOccupazione m730:CreditoImpostaMediazioni m730:CreditoErogazioniCultura m730:CreditoNegoziazione m730:CreditoErogazioniScuola m730:CreditoVideosorveglianza

element **Primo_Modulo_Crediti_Imposta_Type/CreditiImpostaFabbricati**

diagram	
namespace	urn:www.agenziaentrate.gov.it:specificheTecniche:sco:730
type	m730:Crediti Imposta Fabbricati Type
children	m730:ResiduoFabbricati m730:CanoniLocazioneNonPercepiti

element **Primo_Modulo_Crediti_Imposta_Type/CreditiImpostaFondiPensione**

diagram	
namespace	urn:www.agenziaentrate.gov.it:specificheTecniche:sco:730
type	extension of m730:Crediti Imposta Fondi Pensione Type
children	m730:AnnoAnticipazione m730:Reintegro m730:SommaReintegrata m730:CreditoAnno m730:ResiduoPrecedenteDichiarazione m730:DiCuiCompensatoF24

element

Primo_Modulo_Crediti_Imposta_Type/CreditiImpostaFondiPensione/ResiduoPrecedenteDichiarazione

diagram					
namespace	urn:www.agenziaentrate.gov.it:specificheTecniche:sco:730				
type	DatoNP_Type				
facets	<table border="1"> <thead> <tr> <th>Kind</th> <th>Value</th> </tr> </thead> <tbody> <tr> <td>pattern</td> <td>[1-9]{1}[0-9]*</td> </tr> </tbody> </table>	Kind	Value	pattern	[1-9]{1}[0-9]*
Kind	Value				
pattern	[1-9]{1}[0-9]*				

element **Primo Modulo Crediti Imposta Type/CreditImpostaFondiPensione/DiCuiCompensatoF24**

diagram	
namespace	urn:www.agenziaentrate.gov.it:specificheTecniche:sco:730
type	DatoNP_Type
facets	Kind Value pattern [1-9]{1}[0-9]*

element **Primo Modulo Crediti Imposta Type/CreditImpostaRedditiEsteri**

diagram	
namespace	urn:www.agenziaentrate.gov.it:specificheTecniche:sco:730
type	m730:Crediti Imposta Redditi Esteri Type
children	m730:StatoEstero m730:Anno m730:RedditoEstero m730:ImpostaEstera m730:RedditoComplessivo m730:Imposta_Lorda m730:ImpostaNetta m730:CreditoDichiarazioniPrecedenti m730:DiCuiStatoEstero

element **Primo Modulo Crediti Imposta Type/CreditoPrimaCasaSismaAbruzzo**

diagram	
---------	--

namespace	urn:www.agenziaentrate.gov.it:specificheTecniche:sco:730
type	extension of m730:Credito Immobile Sisma Abruzzo Type
children	m730:CodiceFiscale m730:NumeroRata m730:TotaleCredito m730:ResiduoPrecedenteDichiarazione

element

Primo_Modulo_Crediti_Imposta_Type/CreditoPrimaCasaSismaAbruzzo/ResiduoPrecedenteDichiarazione

diagram	
namespace	urn:www.agenziaentrate.gov.it:specificheTecniche:sco:730
type	DatoNP Type
facets	Kind Value pattern [1-9]{1}[0-9]*

element Primo_Modulo_Crediti_Imposta_Type/CreditoAltriSismaAbruzzo

diagram	
namespace	urn:www.agenziaentrate.gov.it:specificheTecniche:sco:730
type	m730:Crediti Imposta Altri Sisma Abruzzo Type
children	m730:Impresa Professione m730:CreditoImmobileSismaAbruzzo m730:Rateazione

element Primo_Modulo_Crediti_Imposta_Type/CreditoIncrementoOccupazione

diagram	
namespace	urn:www.agenziaentrate.gov.it:specificheTecniche:sco:730
type	m730:Credito Incremento Occupazione Type
children	m730:ResiduoPrecedenteDichiarazione m730:DiCuiCompensatoF24

element **Primo_Modulo_Crediti_Imposta_Type/CreditoImpostaMediazioni**

diagram	
namespace	urn:www.agenziaentrate.gov.it:specificheTecniche:sco:730
type	m730:Residuo_Credito_Compens_AnnoImposta_Type
children	m730:CreditoAnno m730:DiCuiCompensatoF24

element **Primo_Modulo_Crediti_Imposta_Type/CreditoErogazioniCultura**

diagram	
namespace	urn:www.agenziaentrate.gov.it:specificheTecniche:sco:730
type	m730:Credito_Erogazioni_Cultura_Type
children	m730:SpesaAnno m730:ResiduoAnnoPrec m730:RataAnnoPrec m730:RataDueAnniPrec

element **Primo_Modulo_Crediti_Imposta_Type/CreditoNegoziazione**

diagram	
namespace	urn:www.agenziaentrate.gov.it:specificheTecniche:sco:730
type	m730:Credito_Negoziiazione_Type
children	m730:CreditoSpettante m730:ResiduoAnnoPrec m730:DiCuiCompensatoF24

element **Primo_Modulo_Crediti_Imposta_Type/CreditoErogazioniScuola**

diagram	
namespace	urn:www.agenziaentrate.gov.it:specificheTecniche:sco:730
type	m730:Credito_Erogazioni_Scuola_Type
children	m730:SpesaAnno

element **Primo_Modulo_Crediti_Imposta_Type/CreditoVideosorveglianza**

diagram	
namespace	urn:www.agenziaentrate.gov.it:specificheTecniche:sco:730
type	m730:Credito_Videosorveglianza_Type
children	m730:CreditoSpettante m730:DiCuiCompensatoF24

complexType **Primo_Modulo_Familiari_Type**

diagram	
namespace	urn:www.agenziaentrate.gov.it:specificheTecniche:sco:730
type	extension of m730:Modulo_Familiari_Type
children	m730:Coniuge m730:PrimoFiglio m730:Familiari m730:PercUlteriore m730:FigliAffidoPread

element **Primo_Modulo_Familiari_Type/PercUlteriore**

diagram					
namespace	urn:www.agenziaentrate.gov.it:specificheTecniche:sco:730				
type	DatoPC_Type				
facets	<table border="1"> <tr> <td>Kind</td> <td>Value</td> </tr> <tr> <td>pattern</td> <td>[0-9]?[0-9](, d{1,3})? 100,0{1,3})?</td> </tr> </table>	Kind	Value	pattern	[0-9]?[0-9](, d{1,3})? 100,0{1,3})?
Kind	Value				
pattern	[0-9]?[0-9](, d{1,3})? 100,0{1,3})?				

element **Primo_Modulo_Familiari_Type/FigliAffidoPread**

diagram					
namespace	urn:www.agenziaentrate.gov.it:specificheTecniche:sco:730				
type	DatoNP_Type				
facets	<table border="1"> <tr> <td>Kind</td> <td>Value</td> </tr> <tr> <td>pattern</td> <td>[1-9]{1}[0-9]*</td> </tr> </table>	Kind	Value	pattern	[1-9]{1}[0-9]*
Kind	Value				
pattern	[1-9]{1}[0-9]*				

complexType **Primo_Modulo_Lavoro_Dip_Type**

diagram	
namespace	urn:www.agenziaentrate.gov.it:specificheTecniche:sco:730
children	m730:LavoroDipendente m730:PremiRisultato m730:PeriodoLavoro m730:AltriRedditiAssLavDip m730:RitenuteLavoroDipendente m730:Bonuslrpef m730:RedditoAlNettoContribPensioni m730:ContribSolidarietaTrattenuto m730:CasellaCasiParticolari

element **Primo_Modulo_Lavoro_Dip_Type/LavoroDipendente**

diagram	
namespace	urn:www.agenziaentrate.gov.it:specificheTecniche:sco:730
type	m730:Lavoro_Dipendente_Type
children	m730:TipologiaReddito m730:TipoContratto m730:Reddito

element **Primo_Modulo_Lavoro_Dip_Type/PremiRisultato**

diagram	
namespace	urn:www.agenziaentrate.gov.it:specificheTecniche:sco:730
type	m730:Premi_Risultato_Type
children	m730:TipoLimite m730:ImportoTassazOrdinaria m730:ImportoImpostaSostitutiva m730:RitenuteImpostaSostitutiva m730:Benefit m730:TassazOrdinaria m730:TassazSostitutiva

element **Primo_Modulo_Lavoro_Dip_Type/PeriodoLavoro**

diagram	
namespace	urn:www.agenziaentrate.gov.it:specificheTecniche:sco:730

type	m730:Periodo Di Lavoro Type
children	m730:GiorniLavoroDipendente m730:GiorniPensione

element **Primo Modulo Lavoro Dip Type/AltriRedditiAssLavDip**

diagram	<pre> classDiagram class m730AltriRedditiAssLavDip { 0..3 } class m730Altri_Redditi_Ass_Lav_Type { m730AssegnoDelConiuge m730ImportoRedditoAssimilato } m730AltriRedditiAssLavDip -- m730Altri_Redditi_Ass_Lav_Type </pre>
namespace	urn:www.agenziaentrate.gov.it:specificheTecniche:sco:730
type	m730:Altri_Redditi_Ass_Lav_Type
children	m730:AssegnoDelConiuge m730:ImportoRedditoAssimilato

element **Primo Modulo Lavoro Dip Type/RitenuteLavoroDipendente**

diagram	<pre> classDiagram class m730RitenuteLavoroDipendente { } class m730Ritenute_Lavoro_Dip_Type { m730Ritlrpef m730RitAddRegionale m730RitAccAddComunale m730RitSaldoAddComunale m730RitAccAddComAnnoPres } m730RitenuteLavoroDipendente -- m730Ritenute_Lavoro_Dip_Type </pre>
namespace	urn:www.agenziaentrate.gov.it:specificheTecniche:sco:730
type	m730:Ritenute_Lavoro_Dip_Type
children	m730:Ritlrpef m730:RitAddRegionale m730:RitAccAddComunale m730:RitSaldoAddComunale m730:RitAccAddComAnnoPres

element **Primo_Modulo_Lavoro_Dip_Type/BonusIrpef**

diagram	
namespace	urn:www.agenziaentrate.gov.it:specificheTecniche:sco:730
type	m730:Bonus_Irpef_Type
children	m730:CodiceBonus m730:BonusErogato m730:Esenzione m730:QuotaTfr

element **Primo_Modulo_Lavoro_Dip_Type/RedditoAlNettoContribPensioni**

diagram					
namespace	urn:www.agenziaentrate.gov.it:specificheTecniche:sco:730				
type	DatoNP_Type				
facets	<table border="1"> <thead> <tr> <th>Kind</th> <th>Value</th> </tr> </thead> <tbody> <tr> <td>pattern</td> <td>[1-9]{1}[0-9]*</td> </tr> </tbody> </table>	Kind	Value	pattern	[1-9]{1}[0-9]*
Kind	Value				
pattern	[1-9]{1}[0-9]*				

element **Primo_Modulo_Lavoro_Dip_Type/ContribSolidarietaTrattenuto**

diagram					
namespace	urn:www.agenziaentrate.gov.it:specificheTecniche:sco:730				
type	DatoNP_Type				
facets	<table border="1"> <thead> <tr> <th>Kind</th> <th>Value</th> </tr> </thead> <tbody> <tr> <td>pattern</td> <td>[1-9]{1}[0-9]*</td> </tr> </tbody> </table>	Kind	Value	pattern	[1-9]{1}[0-9]*
Kind	Value				
pattern	[1-9]{1}[0-9]*				

element **Primo_Modulo_Lavoro_Dip_Type/CasellaCasiParticolari**

diagram													
namespace	urn:www.agenziaentrate.gov.it:specificheTecniche:sco:730												
type	restriction of DatoN1_Type												
facets	<table border="1"> <thead> <tr> <th>Kind</th> <th>Value</th> </tr> </thead> <tbody> <tr> <td>pattern</td> <td>[1-9]</td> </tr> <tr> <td>enumeration</td> <td>1</td> </tr> <tr> <td>enumeration</td> <td>2</td> </tr> <tr> <td>enumeration</td> <td>4</td> </tr> <tr> <td>enumeration</td> <td>5</td> </tr> </tbody> </table>	Kind	Value	pattern	[1-9]	enumeration	1	enumeration	2	enumeration	4	enumeration	5
Kind	Value												
pattern	[1-9]												
enumeration	1												
enumeration	2												
enumeration	4												
enumeration	5												

complexType **Primo_Modulo_Oneri_Type**

<p>diagram</p>	
<p>namespace</p>	<p>urn:www.agenziaentrate.gov.it:specificheTecniche:sco:730</p>
<p>children</p>	<p>m730:SpeseDetrazioni m730:SpeseDeduzioni m730:InterventoRecuperoPatrimonioEdilizio m730:DatiCatastaliRecuperoPatrimonioEdilizio m730:InterventoRisparmioEnergetico m730:CanoniLocazione m730:DatiAltreDetrazioni m730:OneriNonAbbattuti m730:SpeseArredo m730:SpeseArredoGiovani m730:IvaAcquistoAbitazione</p>

element **Primo_Modulo_Oneri_Type/SpeseDetrazioni**

<p>diagram</p>	
<p>namespace</p>	<p>urn:www.agenziaentrate.gov.it:specificheTecniche:sco:730</p>
<p>type</p>	<p>m730:Detrazioni_Type</p>
<p>children</p>	<p>m730:CasellaRateazione m730:SpeseDeterminatePatologie m730:SpeseSanitarie m730:SpeseFamNonACarico m730:SpeseSanitarieDisabili m730:VeicoliDisabili m730:AcquistoCaniGuida m730:SpeseRateizzate m730:MutuiAbPrincipale m730:AltreSpese m730:SpeseLeasing</p>

element **Primo_Modulo_Oneri_Type/SpeseDeduzioni**

<p>diagram</p>	
<p>namespace</p>	<p>urn:www.agenziaentrate.gov.it:specificheTecniche:sco:730</p>
<p>type</p>	<p>m730:Deduzioni_Type</p>
<p>children</p>	<p>m730:ContributiPrevAss m730:AssegnoConiuge m730:ContributiColf m730:ErogazionilstituzioniReligiose m730:SpesePortatoriHandicap m730:AltriOneri m730:DeducibilitaOrdinaria m730:LavoratoriPrimaOccupazione m730:FondiInSquilibrioFinanziario m730:FamiliariACarico m730:FondoPensioneDipendentiPubblici m730:AcquistoCostruzioneAbitLocazione m730:RestituzioneSomme</p>

element **Primo_Modulo_Oneri_Type/InterventoRecuperoPatrimonioEdilizio**

<p>diagram</p>	
<p>namespace</p>	<p>urn:www.agenziaentrate.gov.it:specificheTecniche:sco:730</p>
<p>type</p>	<p>m730:Intervento Recupero Patrimonio Edilizio Type</p>
<p>children</p>	<p>m730:Anno m730:Periodo m730:CodiceFiscale m730:CasellaInterventiParticolari m730:CodiceSituazioniParticolari m730:Rate10 m730:Spesa m730:NOrdineImmobile</p>

element **Primo_Modulo_Oneri_Type/DatiCatastaliRecuperoPatrimonioEdilizio**

<p>diagram</p>	
<p>namespace</p>	<p>urn:www.agenziaentrate.gov.it:specificheTecniche:sco:730</p>
<p>type</p>	<p>m730:Sezione Dati Catastali Recupero Patrimonio Edilizio Type</p>
<p>children</p>	<p>m730:DatiCatastaliRecuperoPatrimonioEdilizio m730:DatiRegistrazioneAccatastamentoRecuperoPatrimonio Edilizio</p>

element **Primo_Modulo_Oneri_Type/InterventoRisparmioEnergico**

<p>diagram</p>	
<p>namespace</p>	<p>urn:www.agenziaentrate.gov.it:specificheTecniche:sco:730</p>
<p>type</p>	<p>m730:Intervento Risparmio Energetico Type</p>
<p>children</p>	<p>m730:TipoIntervento m730:Anno m730:Periodo2013 m730:CasiParticolari m730:RideterminazioneRate m730:RipartizioneRate m730:NumeroRata m730:Spesa</p>

element **Primo_Modulo_Oneri_Type/CanoniLocazione**

<p>diagram</p>	
<p>namespace</p>	<p>urn:www.agenziaentrate.gov.it:specificheTecniche:sco:730</p>
<p>type</p>	<p>m730:Detrazioni Canoni Locazione Type</p>
<p>children</p>	<p>m730:InquiliniAbitazionePrincipale m730:DipendentiTrasferiti</p>

element **Primo_Modulo_Oneri_Type/DatiAltreDetrazioni**

diagram	
namespace	urn:www.agenziaentrate.gov.it:specificheTecniche:sco:730
type	m730:Dati_Altre_Detrazioni_Type
children	m730:SpeseCaniGuida m730:AffittoTerreniAgricoliGiovani m730:AltreDetrazioni

element **Primo_Modulo_Oneri_Type/OneriNonAbbattuti**

diagram	
namespace	urn:www.agenziaentrate.gov.it:specificheTecniche:sco:730
type	m730:Oneri Non Abbattuti_Type
children	m730:DetrazSpeseAssPersonale m730:DetrazErogazBiennaleVenezia m730:DetrazErogazSpettacolo m730:DetrazErogazSettoreMusicale m730:DeduzContributiPaesiSviluppo m730:DeduzOnlus m730:DetrazOspedaleGalliera m730:PrevidenzaCompIDipPubblici m730:InteressiMutuiAgrari m730:DeduzTrust

element **Primo_Modulo_Oneri_Type/SpeseArredo**

diagram	
namespace	urn:www.agenziaentrate.gov.it:specificheTecniche:sco:730
type	m730:Spese_Arredo_Type
children	m730:NumeroRata m730:Importo

element **Primo_Modulo_Oneri_Type/SpeseArredoGiovani**

diagram	
namespace	urn:www.agenziaentrate.gov.it:specificheTecniche:sco:730
type	m730:Spese_Arredo_Giovani_Coppie_Type
children	m730:Meno35Anni m730:NumeroRata m730:Importo

element **Primo_Modulo_Oneri_Type/IvaAcquistoAbitazione**

diagram	
namespace	urn:www.agenziaentrate.gov.it:specificheTecniche:sco:730
type	m730:Iva_Acquisto_Abitazione_Type
children	m730:NumeroRata m730:Importo

complexType **Primo_Modulo_PL_Type**

diagram	
---------	--

namespace	urn:www.agenziaentrate.gov.it:specificheTecniche:sco:730
children	m730:Prospetto m730:ProspettoRideterminato

element **Primo_Modulo_PL_Type/Prospetto**

diagram	
namespace	urn:www.agenziaentrate.gov.it:specificheTecniche:sco:730
type	extension of m730:Prospetto_Type
children	m730:RiepilogoRedditi m730:ImpostaLorda m730:DetrazioniCrediti m730:ImpostaNetta m730:Addizionali m730:CedolareSecca m730:ContributoSolidarieta m730:LiquidazioneImposte m730:AltriDati m730:CredImpEstero m730:DatiCreditiF24

element **Primo_Modulo_PL_Type/Prospetto/Addizionali**

<p>diagram</p>	
<p>namespace</p>	<p>urn:www.agenziaentrate.gov.it:specificheTecniche:sco:730</p>
<p>type</p>	<p>m730:Addizionali_Type</p>
<p>children</p>	<p>m730:Imponibile m730:AddRegDovuta m730:AddRegCertif m730:EccedenzaAddReg m730:AddComDovuta m730:AddComCertif m730:EccedenzaAddCom m730:AccontoAddCom m730:AccontoAddComCertif</p>

element **Primo_Modulo_PL_Type/Prospetto/CedolareSecca**

<p>diagram</p>	
<p>namespace</p>	<p>urn:www.agenziaentrate.gov.it:specificheTecniche:sco:730</p>
<p>type</p>	<p>m730:Cedolare_Secca_Type</p>
<p>children</p>	<p>m730:CedolareDovuta m730:EccedenzaCedolareSecca m730:AccontoCedolare</p>

element **Primo_Modulo_PL_Type/Prospetto/ContributoSolidarieta**

diagram	<pre> classDiagram class m730_ContributoSolidarieta class m730_Contributo_Solidarieta_Type { m730:ImponibileContributo m730:ContributoDovuto m730:ContributoCertificaz } m730_ContributoSolidarieta < -- m730_Contributo_Solidarieta_Type </pre>
namespace	urn:www.agenziaentrate.gov.it:specificheTecniche:sco:730
type	m730:Contributo_Solidarieta_Type
children	m730:ImponibileContributo m730:ContributoDovuto m730:ContributoCertificaz

element **Primo_Modulo_PL_Type/Prospetto/LiquidazioneImposte**

diagram	<pre> classDiagram class m730_LiquidazioneImposte class m730_EsitoIrpref class m730_EsitoAddRegionale class m730_EsitoAddComunale class m730_PrimaRataAcclrpref class m730_SecondaRataAcclrpref class m730_AccontoTassSep class m730_AccontoAddComunale class m730_ImpostaSostitutiva class m730_EsitoCedolareSecca class m730_PrimaRataAccCedolare class m730_SecondaRataAccCedolare class m730_ContribSolidarietaDebito m730_LiquidazioneImposte < -- m730_EsitoIrpref m730_LiquidazioneImposte < -- m730_EsitoAddRegionale m730_LiquidazioneImposte < -- m730_EsitoAddComunale m730_LiquidazioneImposte < -- m730_PrimaRataAcclrpref m730_LiquidazioneImposte < -- m730_SecondaRataAcclrpref m730_LiquidazioneImposte < -- m730_AccontoTassSep m730_LiquidazioneImposte < -- m730_AccontoAddComunale m730_LiquidazioneImposte < -- m730_ImpostaSostitutiva m730_LiquidazioneImposte < -- m730_EsitoCedolareSecca m730_LiquidazioneImposte < -- m730_PrimaRataAccCedolare m730_LiquidazioneImposte < -- m730_SecondaRataAccCedolare m730_LiquidazioneImposte < -- m730_ContribSolidarietaDebito </pre>
namespace	urn:www.agenziaentrate.gov.it:specificheTecniche:sco:730
children	m730:EsitoIrpref m730:EsitoAddRegionale m730:EsitoAddComunale m730:PrimaRataAcclrpref m730:SecondaRataAcclrpref m730:AccontoTassSep m730:AccontoAddComunale m730:ImpostaSostitutiva m730:EsitoCedolareSecca m730:PrimaRataAccCedolare m730:SecondaRataAccCedolare m730:ContribSolidarietaDebito

element **Primo_Modulo_PL_Type/Prospetto/LiquidazioneImposte/EsitoIrpef**

diagram	
namespace	urn:www.agenziaentrate.gov.it:specificheTecniche:sco:730
type	m730:Esito_Liquidazione_Type
children	m730:Credito m730:Debito

element **Primo_Modulo_PL_Type/Prospetto/LiquidazioneImposte/EsitoAddRegionale**

diagram	
namespace	urn:www.agenziaentrate.gov.it:specificheTecniche:sco:730
type	extension of m730:Esito_Liquidazione_Type
children	m730:Credito m730:Debito m730:CodAddReg

element **Primo_Modulo_PL_Type/Prospetto/LiquidazioneImposte/EsitoAddRegionale/CodAddReg**

diagram																																					
namespace	urn:www.agenziaentrate.gov.it:specificheTecniche:sco:730																																				
type	Codice Regione Type																																				
facets	<table border="1"> <thead> <tr> <th>Kind</th> <th>Value</th> </tr> </thead> <tbody> <tr> <td>pattern</td> <td>(([0-9A-Z-] &quot;){1}([0-9A-Z&amp;] ' - \., /° √\(\) À É Ê Ï Ò Ù Ü &quot;; \\ / +)*</td> </tr> <tr><td>enumeration</td><td>1</td></tr> <tr><td>enumeration</td><td>2</td></tr> <tr><td>enumeration</td><td>3</td></tr> <tr><td>enumeration</td><td>4</td></tr> <tr><td>enumeration</td><td>5</td></tr> <tr><td>enumeration</td><td>6</td></tr> <tr><td>enumeration</td><td>7</td></tr> <tr><td>enumeration</td><td>8</td></tr> <tr><td>enumeration</td><td>9</td></tr> <tr><td>enumeration</td><td>10</td></tr> <tr><td>enumeration</td><td>11</td></tr> <tr><td>enumeration</td><td>12</td></tr> <tr><td>enumeration</td><td>13</td></tr> <tr><td>enumeration</td><td>14</td></tr> <tr><td>enumeration</td><td>15</td></tr> <tr><td>enumeration</td><td>16</td></tr> </tbody> </table>	Kind	Value	pattern	(([0-9A-Z-] "){1}([0-9A-Z&] ' - \., /° √\(\) À É Ê Ï Ò Ù Ü "; \\ / +)*	enumeration	1	enumeration	2	enumeration	3	enumeration	4	enumeration	5	enumeration	6	enumeration	7	enumeration	8	enumeration	9	enumeration	10	enumeration	11	enumeration	12	enumeration	13	enumeration	14	enumeration	15	enumeration	16
Kind	Value																																				
pattern	(([0-9A-Z-] "){1}([0-9A-Z&] ' - \., /° √\(\) À É Ê Ï Ò Ù Ü "; \\ / +)*																																				
enumeration	1																																				
enumeration	2																																				
enumeration	3																																				
enumeration	4																																				
enumeration	5																																				
enumeration	6																																				
enumeration	7																																				
enumeration	8																																				
enumeration	9																																				
enumeration	10																																				
enumeration	11																																				
enumeration	12																																				
enumeration	13																																				
enumeration	14																																				
enumeration	15																																				
enumeration	16																																				

	enumeration	17
	enumeration	18
	enumeration	19
	enumeration	20
	enumeration	21

element **Primo_Modulo_PL_Type/Prospetto/LiquidazioneImposte/EsitoAddComunale**

diagram	<p>The diagram shows a class <code>m730:EsitoAddComunale</code> (dashed border) extending <code>m730:Esito_Liquidazione_Type</code> (yellow background). The extension includes three elements: <code>m730:Credito</code>, <code>m730:Debito</code>, and <code>m730:CodiceAddCom</code>.</p>
namespace	urn:www.agenziaentrate.gov.it:specificheTecniche:sco:730
type	extension of m730:Esito_Liquidazione_Type
children	m730:Credito m730:Debito m730:CodiceAddCom

element **Primo_Modulo_PL_Type/Prospetto/LiquidazioneImposte/EsitoAddComunale/CodiceAddCom**

diagram	<p>The diagram shows a class <code>m730:CodiceAddCom</code>.</p>				
namespace	urn:www.agenziaentrate.gov.it:specificheTecniche:sco:730				
type	DatoAN_Type				
facets	<table border="1"> <tr> <th>Kind</th> <th>Value</th> </tr> <tr> <td>pattern</td> <td>(([0-9A-Z-] &quot;){1})([0-9A-Z&amp;] " - \., / "^\(\ \)\ À É È Ì Ò Ù Ü &quot; \ \\ / +)*</td> </tr> </table>	Kind	Value	pattern	(([0-9A-Z-] "){1})([0-9A-Z&] " - \., / "^\(\ \)\ À É È Ì Ò Ù Ü " \ \\ / +)*
Kind	Value				
pattern	(([0-9A-Z-] "){1})([0-9A-Z&] " - \., / "^\(\ \)\ À É È Ì Ò Ù Ü " \ \\ / +)*				

element **Primo_Modulo_PL_Type/Prospetto/LiquidazioneImposte/PrimaRataAcclrpef**

diagram	<p>The diagram shows a class <code>m730:PrimaRataAcclrpef</code>.</p>				
namespace	urn:www.agenziaentrate.gov.it:specificheTecniche:sco:730				
type	DatoNP_Type				
facets	<table border="1"> <tr> <th>Kind</th> <th>Value</th> </tr> <tr> <td>pattern</td> <td>[1-9]{1}[0-9]*</td> </tr> </table>	Kind	Value	pattern	[1-9]{1}[0-9]*
Kind	Value				
pattern	[1-9]{1}[0-9]*				

element **Primo_Modulo_PL_Type/Prospetto/LiquidazioneImposte/SecondaRataAcclrpef**

diagram	<p>The diagram shows a class <code>m730:SecondaRataAcclrpef</code>.</p>				
namespace	urn:www.agenziaentrate.gov.it:specificheTecniche:sco:730				
type	DatoNP_Type				
facets	<table border="1"> <tr> <th>Kind</th> <th>Value</th> </tr> <tr> <td>pattern</td> <td>[1-9]{1}[0-9]*</td> </tr> </table>	Kind	Value	pattern	[1-9]{1}[0-9]*
Kind	Value				
pattern	[1-9]{1}[0-9]*				

element **Primo_Modulo_PL_Type/Prospetto/LiquidazioneImposte/AccontoTassSep**

diagram	
namespace	urn:www.agenziaentrate.gov.it:specificheTecniche:sco:730
type	m730:Debito_Type
children	m730:NonVersare m730:ImportoDaTrattenere

element **Primo_Modulo_PL_Type/Prospetto/LiquidazioneImposte/AccontoAddComunale**

diagram	
namespace	urn:www.agenziaentrate.gov.it:specificheTecniche:sco:730
children	m730:CodiceAddComAcconto m730:AccontoAddCom

element

Primo_Modulo_PL_Type/Prospetto/LiquidazioneImposte/AccontoAddComunale/CodiceAddComAcconto

diagram					
namespace	urn:www.agenziaentrate.gov.it:specificheTecniche:sco:730				
type	DatoAN_Type				
facets	<table border="1"> <thead> <tr> <th>Kind</th> <th>Value</th> </tr> </thead> <tbody> <tr> <td>pattern</td> <td>([0-9A-Z\-\ &quot;]{1})([0-9A-Z&amp;] '\ -\ \. \, \° \^ \(\) À È É Ì Ò Ù Û &quot; \ \\ \ +)*</td> </tr> </tbody> </table>	Kind	Value	pattern	([0-9A-Z\-\ "]{1})([0-9A-Z&] '\ -\ \. \, \° \^ \(\) À È É Ì Ò Ù Û " \ \\ \ +)*
Kind	Value				
pattern	([0-9A-Z\-\ "]{1})([0-9A-Z&] '\ -\ \. \, \° \^ \(\) À È É Ì Ò Ù Û " \ \\ \ +)*				

element

Primo_Modulo_PL_Type/Prospetto/LiquidazioneImposte/AccontoAddComunale/AccontoAddCom

diagram					
namespace	urn:www.agenziaentrate.gov.it:specificheTecniche:sco:730				
type	DatoNP_Type				
facets	<table border="1"> <thead> <tr> <th>Kind</th> <th>Value</th> </tr> </thead> <tbody> <tr> <td>pattern</td> <td>[1-9]{1}[0-9]*</td> </tr> </tbody> </table>	Kind	Value	pattern	[1-9]{1}[0-9]*
Kind	Value				
pattern	[1-9]{1}[0-9]*				

element **Primo_Modulo_PL_Type/Prospetto/LiquidazioneImposte/ImpostaSostitutiva**

diagram	<p>The diagram shows a dashed box labeled 'm730:ImpostaSostitutiva' connected to a central node. This node is connected to a larger dashed box labeled 'm730:Debito_Type'. Inside 'm730:Debito_Type', there are two sub-nodes: 'm730:NonVersare' and 'm730:ImportoDaTrattenere'.</p>
namespace	urn:www.agenziaentrate.gov.it:specificheTecniche:sco:730
type	m730:Debito_Type
children	m730:NonVersare m730:ImportoDaTrattenere

element **Primo_Modulo_PL_Type/Prospetto/LiquidazioneImposte/EsitoCedolareSecca**

diagram	<p>The diagram shows a dashed box labeled 'm730:EsitoCedolareSecca' connected to a central node. This node is connected to a larger dashed box labeled 'm730:Esito_Liquidazione_Type'. Inside 'm730:Esito_Liquidazione_Type', there are two sub-nodes: 'm730:Credito' and 'm730:Debito'.</p>
namespace	urn:www.agenziaentrate.gov.it:specificheTecniche:sco:730
type	m730:Esito_Liquidazione_Type
children	m730:Credito m730:Debito

element **Primo_Modulo_PL_Type/Prospetto/LiquidazioneImposte/PrimaRataAccCedolare**

diagram	<p>The diagram shows a dashed box labeled 'm730:PrimaRataAccCedolare'.</p>				
namespace	urn:www.agenziaentrate.gov.it:specificheTecniche:sco:730				
type	DatoNP_Type				
facets	<table border="1"> <thead> <tr> <th>Kind</th> <th>Value</th> </tr> </thead> <tbody> <tr> <td>pattern</td> <td>[1-9]{1}[0-9]*</td> </tr> </tbody> </table>	Kind	Value	pattern	[1-9]{1}[0-9]*
Kind	Value				
pattern	[1-9]{1}[0-9]*				

element **Primo_Modulo_PL_Type/Prospetto/LiquidazioneImposte/SecondaRataAccCedolare**

diagram	<p>The diagram shows a dashed box labeled 'm730:SecondaRataAccCedolare'.</p>				
namespace	urn:www.agenziaentrate.gov.it:specificheTecniche:sco:730				
type	DatoNP_Type				
facets	<table border="1"> <thead> <tr> <th>Kind</th> <th>Value</th> </tr> </thead> <tbody> <tr> <td>pattern</td> <td>[1-9]{1}[0-9]*</td> </tr> </tbody> </table>	Kind	Value	pattern	[1-9]{1}[0-9]*
Kind	Value				
pattern	[1-9]{1}[0-9]*				

element **Primo_Modulo_PL_Type/Prospetto/LiquidazioneImposte/ContribSolidarietaDebito**

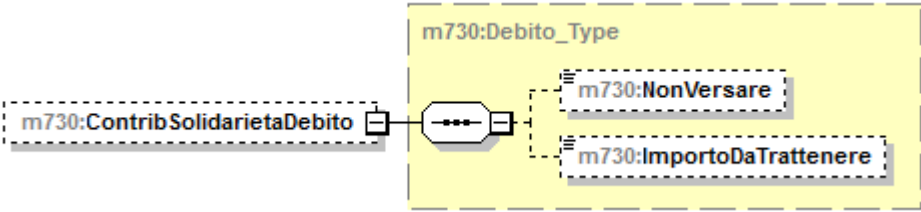
<p>diagram</p>	 <p>The diagram shows a class <code>m730:ContribSolidarietaDebito</code> (represented by a dashed box) associated with a class <code>m730:Debito_Type</code> (represented by a yellow box). The association is shown as a solid line with an open arrowhead pointing to <code>m730:Debito_Type</code>. Inside <code>m730:Debito_Type</code>, there are two subclasses: <code>m730:NonVersare</code> and <code>m730:ImportoDaTrattenere</code>, both shown in dashed boxes.</p>
<p>namespace</p>	<p>urn:www.agenziaentrate.gov.it:specificheTecniche:sco:730</p>
<p>type</p>	<p>m730:Debito_Type</p>
<p>children</p>	<p>m730:NonVersare m730:ImportoDaTrattenere</p>

element **Primo_Modulo_PL_Type/Prospetto/AltriDati**

<p>diagram</p>	
<p>namespace</p>	<p>urn:www.agenziaentrate.gov.it:specificheTecniche:sco:730</p>
<p>type</p>	<p>m730:Altri_Dati_Type</p>
<p>children</p>	<p> m730:ResiduoCreditoErogazioneCultura m730:ResiduoCreditoPrimaCasa m730:ResiduoCreditoOccupazione m730:ResiduoCreditoSisma m730:ResiduoCreditoFondiPensione m730:ResiduoCreditoMediazioni m730:TotSpeseSanitarieRateizzate m730:RedditoAgevolazioniFiscali m730:RedditoComplessivoAcconto m730:RigoDifferenzaAcconto m730:AccontiCompensatiIntern m730:RedditiFondiariniNonImponibili m730:RedditoAbitazionePrincipalePertinenze m730:ResiduoDeduzioneSommeRestituite m730:ResiduoErogazioniScuola m730:ResiduoCreditoNegoziazione m730:ResiduoCreditoVideosorveglianza m730:CreditoErogazioneCultura </p>

element **Primo_Modulo_PL_Type/Prospetto/CredImpEstero**

<p>diagram</p>	
<p>namespace</p>	<p>urn:www.agenziaentrate.gov.it:specificheTecniche:sco:730</p>
<p>type</p>	<p>m730:Cred_Imp_Estero_Type</p>
<p>children</p>	<p>m730:Anno m730:TotCredito m730:CreditoStato</p>

element **Primo_Modulo_PL_Type/Prospetto/DatiCreditiF24**

<p>diagram</p>	
----------------	--

namespace	urn:www.agenziaentrate.gov.it:specificheTecniche:sco:730
type	m730:Crediti_F24_Type
children	m730:Credlrpef m730:CredlrpefDipNoSostituto m730:CodAddReg m730:CredAddReg m730:CredAddRegDipNoSostituto m730:CodiceAddCom m730:CredAddCom m730:CredAddComDipNoSostituto m730:CredCedolare m730:CredCedolareDipNoSostituto m730:CredTassSeparDipNoSostituto m730:CredImpostaSostDipNoSostituto m730:CredSolidarietaDipNoSostituto m730:Totale m730:TotaleDipNoSostituto

element **Primo_Modulo_PL_Type/ProspettoRideterminato**

diagram	<p>The diagram illustrates the structure of <code>m730:ProspettoRideterminato</code> as an extension of <code>m730:Prospetto_Type</code>. The base type is shown in a dashed box on the left. The extension is highlighted in a yellow box on the right and contains five elements, each in a dashed box with a plus sign: <code>m730:RiepilogoRedditi</code>, <code>m730:ImpostaLorda</code>, <code>m730:DetrazioniCrediti</code>, <code>m730:ImpostaNetta</code>, and <code>m730:RedditoAgevolazioniFiscali</code>. The extension is connected to the base type via a solid line with a plus sign.</p>
namespace	urn:www.agenziaentrate.gov.it:specificheTecniche:sco:730
type	extension of m730:Prospetto_Type
children	m730:RiepilogoRedditi m730:ImpostaLorda m730:DetrazioniCrediti m730:ImpostaNetta m730:RedditoAgevolazioniFiscali

element **Primo_Modulo_PL_Type/ProspettoRideterminato/RedditoAgevolazioniFiscali**

diagram	<p>The diagram shows <code>m730:RedditoAgevolazioniFiscali</code> as a <code>DatoNP_Type</code>, represented by a dashed box with a plus sign.</p>				
namespace	urn:www.agenziaentrate.gov.it:specificheTecniche:sco:730				
type	DatoNP_Type				
facets	<table border="1"> <thead> <tr> <th>Kind</th> <th>Value</th> </tr> </thead> <tbody> <tr> <td>pattern</td> <td>[1-9]{1}[0-9]*</td> </tr> </tbody> </table>	Kind	Value	pattern	[1-9]{1}[0-9]*
Kind	Value				
pattern	[1-9]{1}[0-9]*				

complexType **Prospetto_Annotazioni_Type**

diagram	<p>The diagram shows <code>Prospetto_Annotazioni_Type</code> as a complex type containing <code>m730:Modulo_Annotazioni</code> with a cardinality of <code>1..∞</code>. The complex type is shown in a solid box with a plus sign, and the child element is in a dashed box with a plus sign.</p>
namespace	urn:www.agenziaentrate.gov.it:specificheTecniche:sco:730
children	m730:Modulo_Annotazioni

element Prospetto_Annotazioni_Type/Modulo_Annotazioni

diagram	
namespace	urn:www.agenziaentrate.gov.it:specificheTecniche:sco:730
type	m730:Modulo_Annotazioni_Type
children	m730:Annotazione

complexType Prospetto_Liquidazione_Type

diagram	
namespace	urn:www.agenziaentrate.gov.it:specificheTecniche:sco:730
children	m730:PrimoModulo m730:Modulo

element Prospetto_Liquidazione_Type/PrimoModulo

diagram	
namespace	urn:www.agenziaentrate.gov.it:specificheTecniche:sco:730
type	m730:Primo_Modulo_PL_Type
children	m730:Prospetto m730:ProspettoRideterminato

element Prospetto_Liquidazione_Type/Modulo

diagram	
namespace	urn:www.agenziaentrate.gov.it:specificheTecniche:sco:730
type	m730:Modulo_PL_Type
children	m730:CredImpEestero

complexType **Prospetto_Type**

diagram	
namespace	urn:www.agenziaentrate.gov.it:specificheTecniche:sco:730
children	m730:RiepilogoRedditi m730:ImpostaLorda m730:DetrazioniCrediti m730:ImpostaNetta

element **Prospetto_Type/RiepilogoRedditi**

diagram	
namespace	urn:www.agenziaentrate.gov.it:specificheTecniche:sco:730
type	m730:Riepilogo_Redditi_Type
children	m730:Dominicali m730:Agrari m730:Fabbricati m730:LavDip m730:AltriRedditi m730:ImponibileCedolare m730:ImponibileCedolareOrdinario m730:ImponibileCedolareAgevolato m730:AbitazionePrincipalePertinenze

element **Prospetto_Type/ImpostaLorda**

<p>diagram</p>	<pre> classDiagram class m730:ImpostaLorda class m730:Imposta_Lorda_Type class m730:RedditoComplessivo class m730:DeduzioneAbitazPrincipale class m730:OneriDeducibili class m730:RedditoImponibile class m730:CompensiAttSport class m730:ImportoImpostaLorda m730:ImpostaLorda "1" *-- "1" m730:Imposta_Lorda_Type m730:Imposta_Lorda_Type "1" *-- "1" m730:RedditoComplessivo m730:Imposta_Lorda_Type "1" *-- "1" m730:DeduzioneAbitazPrincipale m730:Imposta_Lorda_Type "1" *-- "1" m730:OneriDeducibili m730:Imposta_Lorda_Type "1" *-- "1" m730:RedditoImponibile m730:Imposta_Lorda_Type "1" *-- "1" m730:CompensiAttSport m730:Imposta_Lorda_Type "1" *-- "1" m730:ImportoImpostaLorda </pre>
<p>namespace</p>	<p>urn:www.agenziaentrato.gov.it:specificheTecniche:sco:730</p>
<p>type</p>	<p>m730:Imposta_Lorda_Type</p>
<p>children</p>	<p>m730:RedditoComplessivo m730:DeduzioneAbitazPrincipale m730:OneriDeducibili m730:RedditoImponibile m730:CompensiAttSport m730:ImportoImpostaLorda</p>

element **Prospetto_Type/DetrazioniCrediti**

<p>diagram</p>	
<p>namespace</p>	<p>urn:www.agenziaentrate.gov.it:specificheTecniche:sco:730</p>
<p>type</p>	<p>m730:Detrazione_Crediti_Type</p>
<p>children</p>	<p>m730:DetrazioneConiuge m730:DetrazioneFigli m730:UlterioreDetrazioneFigli m730:DetrazioneFamiliari m730:DetrazioneLavDip m730:DetrazionePens m730:DetrazioneAltriRedditi m730:DetrazioneOneri m730:DetrazioneRistrutturazione m730:DetrazioniArredolmmobili m730:DetrazioneRisparmioEnergetico m730:DetrazioneArredoGiovani... m730:DetrazioneIvaAcquistoAbit... m730:DetrazioneLocEAgricoliGio... m730:AltreDetrazioni m730:CreditoPrimaCasa m730:CreditoOccupazione m730:CreditoFondiPensione m730:CreditoMediazioni m730:CreditoNegoziazione m730:TotaleDetrazioniCrediti</p>

[m730:DetrazioneArredoGiovaniCoppie](#) [m730:DetrazioneIvaAcquistoAbitaz](#) [m730:DetrazioneLocEAgricoliGiovani](#)
[m730:AltreDetrazioni](#) [m730:CreditoPrimaCasa](#) [m730:CreditoOccupazione](#) [m730:CreditoFondiPensione](#)
[m730:CreditoMediazioni](#) [m730:CreditoNegoziazione](#) [m730:TotaleDetrazioniCrediti](#)

element **Prospetto_Type/ImpostaNetta**

<p>diagram</p>	
<p>namespace</p>	<p>urn:www.agenziaentrate.gov.it:specificheTecniche:sco:730</p>
<p>type</p>	<p>m730:Imposta_Netta_Type</p>
<p>children</p>	<p>m730:ImportoImpostaNetta m730:CredAltriSisma m730:CredAbitazSisma m730:CredImpEstere m730:CredErogCultura m730:CredErogScuola m730:CredVideosorveglianza m730:CredCanNonPerc m730:CredDetrazIncapienti m730:Ritenute m730:Differenza m730:EccedenzaIrpéf m730:AccontiVersati m730:RestituzioneBonus m730:CredRimborsatiSost m730:BonusIrpéfSpettante m730:BonusIrpéfRiconosciuto m730:RestituzioneBonusIrpéf</p>

	m730:RestituzioneBonuslrpef
--	---

complexType **Quadro_I_Type**

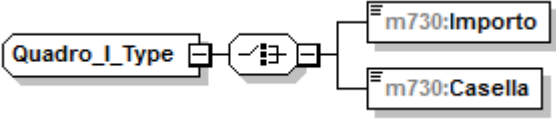
diagram	
namespace	urn:www.agenziaentrate.gov.it:specificheTecniche:sco:730
children	m730:Importo m730:Casella

element **Quadro_I_Type/Importo**

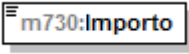
diagram					
namespace	urn:www.agenziaentrate.gov.it:specificheTecniche:sco:730				
type	DatoNP_Type				
facets	<table border="1"> <thead> <tr> <th>Kind</th> <th>Value</th> </tr> </thead> <tbody> <tr> <td>pattern</td> <td>[1-9]{1}[0-9]*</td> </tr> </tbody> </table>	Kind	Value	pattern	[1-9]{1}[0-9]*
Kind	Value				
pattern	[1-9]{1}[0-9]*				

element **Quadro_I_Type/Casella**

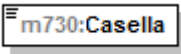
diagram					
namespace	urn:www.agenziaentrate.gov.it:specificheTecniche:sco:730				
type	DatoCB_Type				
facets	<table border="1"> <thead> <tr> <th>Kind</th> <th>Value</th> </tr> </thead> <tbody> <tr> <td>pattern</td> <td>[01]</td> </tr> </tbody> </table>	Kind	Value	pattern	[01]
Kind	Value				
pattern	[01]				

complexType **Quadro_K_Type**

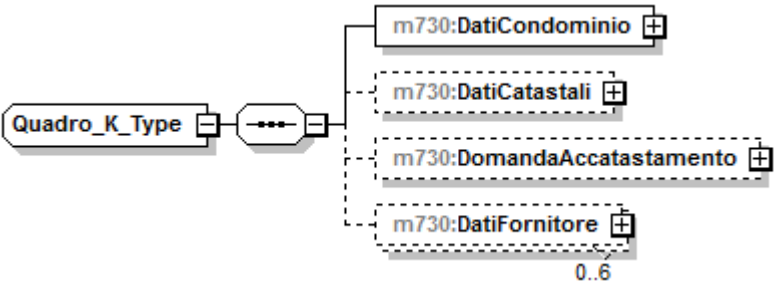
diagram	
namespace	urn:www.agenziaentrate.gov.it:specificheTecniche:sco:730
children	m730:DatiCondominio m730:DatiCatastali m730:DomandaAccatastamento m730:DatiFornitore

element **Quadro_K_Type/DatiCondominio**

diagram	<p>The diagram shows a box labeled 'm730:DatiCondominio' connected to a central connector box. This connector is linked to a larger dashed box labeled 'm730:Dati_Condominio_Type'. Inside this dashed box, there are two smaller boxes: 'm730:CodiceFiscale' and 'm730:Denominazione'.</p>
namespace	urn:www.agenziaentrate.gov.it:specificheTecniche:sco:730
type	m730:Dati_Condominio_Type
children	m730:CodiceFiscale m730:Denominazione

element **Quadro_K_Type/DatiCatastali**

diagram	<p>The diagram shows a dashed box labeled 'm730:DatiCatastali' connected to a central connector box. This connector is linked to a larger dashed box labeled 'm730:Dati_Catastali_Type'. Inside this dashed box, there are six smaller boxes: 'm730:CodiceComune', 'm730:TerreniUrbano', 'm730:SezioneUrbanaComuneCatastale', 'm730:Foglio', 'm730:Particella', and 'm730:Subalterno'.</p>
namespace	urn:www.agenziaentrate.gov.it:specificheTecniche:sco:730
type	m730:Dati_Catastali_Type
children	m730:CodiceComune m730:TerreniUrbano m730:SezioneUrbanaComuneCatastale m730:Foglio m730:Particella m730:Subalterno

element **Quadro_K_Type/DomandaAccatastamento**

diagram	<p>The diagram shows a dashed box labeled 'm730:DomandaAccatastamento' connected to a central connector box. This connector is linked to a larger dashed box labeled 'm730:Domanda_Accatastamento_Type'. Inside this dashed box, there are three smaller boxes: 'm730:Data', 'm730:Numero', and 'm730:ProvinciaUfficio'.</p>
namespace	urn:www.agenziaentrate.gov.it:specificheTecniche:sco:730
type	m730:Domanda_Accatastamento_Type

children	m730:Data m730:Numero m730:ProvinciaUfficio
----------	---

element **Quadro_K_Type/DatiFornitore**

diagram	
namespace	urn:www.agenziaentrate.gov.it:specificheTecniche:sco:730
type	m730:Dati_Fornitore_Type
children	m730:CodiceFiscale m730:CognomeDenom m730:Nome m730:Sesso m730:DataNascita m730:ComuneNascita m730:ProvinciaNascita m730:ImportoAcquisti

complexType **Rappresentante_Type**

diagram	
namespace	urn:www.agenziaentrate.gov.it:specificheTecniche:sco:730
children	m730:SoggettoFiscale m730:DatiAnagrafici m730:ResidenzaAnagrafica m730:Firma

element **Rappresentante_Type/SoggettoFiscale**

diagram	
namespace	urn:www.agenziaentrate.gov.it:specificheTecniche:sco:730
type	m730:Soggetto_Fiscale_730_Type
children	m730:CodiceFiscale m730:Email m730:Telefono m730:Cellulare

element **Rappresentante_Type/DatiAnagrafici**

diagram	
namespace	urn:www.agenziaentrate.gov.it:specificheTecniche:sco:730
type	Dati_Anagrafici_Type
children	Cognome Nome Sesso DataNascita ComuneNascita ProvinciaNascita

element **Rappresentante_Type/ResidenzaAnagrafica**

diagram	
namespace	urn:www.agenziaentrate.gov.it:specificheTecniche:sco:730
type	m730:Residenza_Rappresentante_Type
children	Comune Provincia CodiceComune Indirizzo Cap m730:Tipologia m730:NumCivico m730:Frazione

element **Rappresentante_Type/Firma**

diagram					
namespace	urn:www.agenziaentrate.gov.it:specificheTecniche:sco:730				
type	DatoCB_Type				
facets	<table border="1"> <thead> <tr> <th>Kind</th> <th>Value</th> </tr> </thead> <tbody> <tr> <td>pattern</td> <td>[01]</td> </tr> </tbody> </table>	Kind	Value	pattern	[01]
Kind	Value				
pattern	[01]				

complexType **Redditi_Capitale_Type**

diagram	
namespace	urn:www.agenziaentrate.gov.it:specificheTecniche:sco:730
children	m730:Utili m730:AltriRedditiDiCapitale m730:LavoroAutonomo m730:RedditiDiversi m730:RedditiDiversiDetraz

element **Redditi_Capitale_Type/Utili**

diagram	
namespace	urn:www.agenziaentrate.gov.it:specificheTecniche:sco:730
type	m730:Altri_Redditi_Utili_Type
children	m730:Tipo_Reddito m730:RedditiRitenute

element **Redditi_Capitale_Type/AltriRedditiDiCapitale**

diagram	
namespace	urn:www.agenziaentrate.gov.it:specificheTecniche:sco:730
type	m730:Sezione_Altri_Redd_Type
children	m730:TipoReddito m730:RedditiRitenute

element **Redditi_Capitale_Type/LavoroAutonomo**

diagram	
namespace	urn:www.agenziaentrate.gov.it:specificheTecniche:sco:730
type	m730:Altri_Redditi_Lavoro_Autonomo_Type
children	m730:TipoReddito m730:RedditiRitenute

element **Redditi_Capitale_Type/RedditiDiversi**

diagram	
namespace	urn:www.agenziaentrate.gov.it:specificheTecniche:sco:730
type	m730:Altri_Redditi_Diversi_Type
children	m730:TipoReddito m730:RedditiRitenuteSpese

element **Redditi_Capitale_Type/RedditiDiversiDetraz**

diagram	
namespace	urn:www.agenziaentrate.gov.it:specificheTecniche:sco:730
type	m730:Altri_Redditi_Diversi_Detr_Type
children	m730:Tipo_Reddito m730:RedditiRitenuteSpese

complexType **Redditi_Eredi_Legatari_Type**

diagram	
namespace	urn:www.agenziaentrate.gov.it:specificheTecniche:sco:730
type	extension of m730:Tassazione_Separata_Type
children	m730:Opzione m730:Anno m730:RedditoRitenute m730:TipoReddito m730:RedditoTotale m730:QuotaImposteSuccessioni

element **Redditi_Eredi_Legatari_Type/TipoReddito**

diagram																													
namespace	urn:www.agenziaentrate.gov.it:specificheTecniche:sco:730																												
type	m730:Tipo_Reddito_Da1a12_Type																												
facets	<table border="1"> <thead> <tr> <th>Kind</th> <th>Value</th> </tr> </thead> <tbody> <tr> <td>pattern</td> <td>[1-9]{1}[0-9]*</td> </tr> <tr> <td>enumeration</td> <td>1</td> </tr> <tr> <td>enumeration</td> <td>2</td> </tr> <tr> <td>enumeration</td> <td>3</td> </tr> <tr> <td>enumeration</td> <td>4</td> </tr> <tr> <td>enumeration</td> <td>5</td> </tr> <tr> <td>enumeration</td> <td>6</td> </tr> <tr> <td>enumeration</td> <td>7</td> </tr> <tr> <td>enumeration</td> <td>8</td> </tr> <tr> <td>enumeration</td> <td>9</td> </tr> <tr> <td>enumeration</td> <td>10</td> </tr> <tr> <td>enumeration</td> <td>11</td> </tr> <tr> <td>enumeration</td> <td>12</td> </tr> </tbody> </table>	Kind	Value	pattern	[1-9]{1}[0-9]*	enumeration	1	enumeration	2	enumeration	3	enumeration	4	enumeration	5	enumeration	6	enumeration	7	enumeration	8	enumeration	9	enumeration	10	enumeration	11	enumeration	12
Kind	Value																												
pattern	[1-9]{1}[0-9]*																												
enumeration	1																												
enumeration	2																												
enumeration	3																												
enumeration	4																												
enumeration	5																												
enumeration	6																												
enumeration	7																												
enumeration	8																												
enumeration	9																												
enumeration	10																												
enumeration	11																												
enumeration	12																												

element **Redditi_Eredi_Legatari_Type/RedditoTotale**

diagram					
namespace	urn:www.agenziaentrate.gov.it:specificheTecniche:sco:730				
type	DatoNP_Type				
facets	<table border="1"> <thead> <tr> <th>Kind</th> <th>Value</th> </tr> </thead> <tbody> <tr> <td>pattern</td> <td>[1-9]{1}[0-9]*</td> </tr> </tbody> </table>	Kind	Value	pattern	[1-9]{1}[0-9]*
Kind	Value				
pattern	[1-9]{1}[0-9]*				

element **Redditi_Eredi_Legatari_Type/QuotalImposteSuccessioni**

diagram					
namespace	urn:www.agenziaentrate.gov.it:specificheTecniche:sco:730				
type	DatoNP_Type				
facets	<table border="1"> <thead> <tr> <th>Kind</th> <th>Value</th> </tr> </thead> <tbody> <tr> <td>pattern</td> <td>[1-9]{1}[0-9]*</td> </tr> </tbody> </table>	Kind	Value	pattern	[1-9]{1}[0-9]*
Kind	Value				
pattern	[1-9]{1}[0-9]*				

complexType **Redditi_Fabbricati_Type**

diagram	
namespace	urn:www.agenziaentrate.gov.it:specificheTecniche:sco:730
children	m730:Modulo

element **Redditi_Fabbricati_Type/Modulo**

diagram	
namespace	urn:www.agenziaentrate.gov.it:specificheTecniche:sco:730
type	m730:Modulo_Fabbricato_Type
children	m730:FabbricatoOrd m730:FabbricatoAgev

complexType **Redditi_Lavoro_Dip_Type**

diagram	
namespace	urn:www.agenziaentrate.gov.it:specificheTecniche:sco:730
children	m730:PrimoModulo m730:Modulo

element **Redditi_Lavoro_Dip_Type/PrimoModulo**

<p>diagram</p>	
<p>namespace</p>	<p>urn:www.agenziaentrate.gov.it:specificheTecniche:sco:730</p>
<p>type</p>	<p>m730:Primo Modulo Lavoro Dip Type</p>
<p>children</p>	<p>m730:LavoroDipendente m730:PremiRisultato m730:PeriodoLavoro m730:AltriRedditiAssLavDip m730:RitenuteLavoroDipendente m730:Bonuslrpef m730:RedditoAlNettoContribPensioni m730:ContribSolidarietaTrattenuto m730:CasellaCasiParticolari</p>

element **Redditi_Lavoro_Dip_Type/Modulo**

<p>diagram</p>	
<p>namespace</p>	<p>urn:www.agenziaentrate.gov.it:specificheTecniche:sco:730</p>
<p>type</p>	<p>m730:Modulo Lavoro Dip Type</p>
<p>children</p>	<p>m730:LavoroDipendente m730:PremiRisultato m730:AltriRedditiAssLavDip m730:Bonuslrpef</p>

complexType Redditi_Ritenute_Spese_Type

diagram	
namespace	urn:www.agenziaentrate.gov.it:specificheTecniche:sco:730
type	extension of m730:Redditi_Ritenute_Type
children	m730:ImportoRedditi m730:ImportoRitenute m730:ImportoSpese

element Redditi_Ritenute_Spese_Type/ImportoSpese

diagram					
namespace	urn:www.agenziaentrate.gov.it:specificheTecniche:sco:730				
type	DatoNP_Type				
facets	<table border="1"> <thead> <tr> <th>Kind</th> <th>Value</th> </tr> </thead> <tbody> <tr> <td>pattern</td> <td>[1-9]{1}[0-9]*</td> </tr> </tbody> </table>	Kind	Value	pattern	[1-9]{1}[0-9]*
Kind	Value				
pattern	[1-9]{1}[0-9]*				

complexType Redditi_Ritenute_Type

diagram	
namespace	urn:www.agenziaentrate.gov.it:specificheTecniche:sco:730
children	m730:ImportoRedditi m730:ImportoRitenute

element Redditi_Ritenute_Type/ImportoRedditi

diagram					
namespace	urn:www.agenziaentrate.gov.it:specificheTecniche:sco:730				
type	DatoNP_Type				
facets	<table border="1"> <thead> <tr> <th>Kind</th> <th>Value</th> </tr> </thead> <tbody> <tr> <td>pattern</td> <td>[1-9]{1}[0-9]*</td> </tr> </tbody> </table>	Kind	Value	pattern	[1-9]{1}[0-9]*
Kind	Value				
pattern	[1-9]{1}[0-9]*				

element **Redditi_Ritenute_Type/ImportoRitenute**

diagram	
namespace	urn:www.agenziaentrate.gov.it:specificheTecniche:sco:730
type	DatoNP_Type
facets	Kind Value pattern [1-9]{1}[0-9]*

complexType **Redditi_Tassazione_Separata_Type**

diagram	
namespace	urn:www.agenziaentrate.gov.it:specificheTecniche:sco:730
children	m730:RedditiErede m730:ImposteRimborsate

element **Redditi_Tassazione_Separata_Type/RedditiErede**

diagram	
namespace	urn:www.agenziaentrate.gov.it:specificheTecniche:sco:730
type	m730:Redditi_Eredi_Legatari_Type
children	m730:Opzione m730:Anno m730:RedditoRitenute m730:TipoReddito m730:RedditoTotale m730:QuotaImposteSuccessioni

element **Redditi_Tassazione_Separata_Type/ImposteRimborsate**

diagram	
namespace	urn:www.agenziaentrate.gov.it:specificheTecniche:sco:730
type	m730:Imposte_Rimborsate_Type
children	m730:TipoReddito m730:TassazioneSeparata

complexType **Redditi_Terreni_Type**

diagram	
namespace	urn:www.agenziaentrate.gov.it:specificheTecniche:sco:730
children	m730:Modulo

element **Redditi_Terreni_Type/Modulo**

diagram	
namespace	urn:www.agenziaentrate.gov.it:specificheTecniche:sco:730
type	m730:Modulo_Terreno_Type
children	m730:Terreno

complexType **Reddito_Erede_Type**

diagram	
namespace	urn:www.agenziaentrate.gov.it:specificheTecniche:sco:730
type	extension of m730:Tassazione_Separata_Type

children	m730:Opzione m730:Anno m730:RedditoRitenute
----------	---

complexType **Residenza_Anagrafica_730_Type**

diagram	
namespace	urn:www.agenziaentrate.gov.it:specificheTecniche:sco:730
type	extension of Residenza_Anagrafica_Type
children	Comune Provincia CodiceComune Indirizzo Cap DataVariazione m730:Tipologia m730:NumCivico m730:Frazione m730:PrimaPresentazione

element **Residenza_Anagrafica_730_Type/Tipologia**

diagram					
namespace	urn:www.agenziaentrate.gov.it:specificheTecniche:sco:730				
type	DatoAN_Type				
facets	<table border="0"> <tr> <td>Kind</td> <td>Value</td> </tr> <tr> <td>pattern</td> <td>([0-9A-Z\-\]]&quot;){1}([0-9A-Z&amp;:] ' - \., / "^\(\ \)\À É È Ì Ò Ù Ü &quot; \\ / +)*</td> </tr> </table>	Kind	Value	pattern	([0-9A-Z\-\]]"){1}([0-9A-Z&:] ' - \., / "^\(\ \)\À É È Ì Ò Ù Ü " \\ / +)*
Kind	Value				
pattern	([0-9A-Z\-\]]"){1}([0-9A-Z&:] ' - \., / "^\(\ \)\À É È Ì Ò Ù Ü " \\ / +)*				

element **Residenza_Anagrafica_730_Type/NumCivico**

diagram	
namespace	urn:www.agenziaentrate.gov.it:specificheTecniche:sco:730
type	DatoAN_Type

facets	Kind Value pattern (([0-9A-Z-] \"){1}([0-9A-Z&#39; ! - \., / ^\\(\\) À É È Ì Ò Ù Û " \\ \\ \\+)*
--------	--

element **Residenza_Anagrafica_730_Type/Frazione**

diagram	
namespace	urn:www.agenziaentrate.gov.it:specificheTecniche:sco:730
type	DatoAN_Type
facets	Kind Value pattern (([0-9A-Z-] \"){1}([0-9A-Z&#39; ! - \., / ^\\(\\) À É È Ì Ò Ù Û " \\ \\ \\+)*

element **Residenza_Anagrafica_730_Type/PrimaPresentazione**

diagram	
namespace	urn:www.agenziaentrate.gov.it:specificheTecniche:sco:730
type	DatoCB_Type
facets	Kind Value pattern [01]

complexType **Residenza_Rappresentante_Type**

diagram	
namespace	urn:www.agenziaentrate.gov.it:specificheTecniche:sco:730
type	extension of Domicilio_Ita_Type
children	Comune Provincia CodiceComune Indirizzo Cap m730:Tipologia m730:NumCivico m730:Frazione

element **Residenza_Rappresentante_Type/Tipologia**

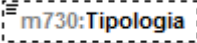
diagram	
namespace	urn:www.agenziaentrate.gov.it:specificheTecniche:sco:730
type	DatoAN_Type
facets	Kind Value pattern ([0-9A-Z-]*)"}{1}([0-9A-Z&:] ' - \., / ^\\(\\) À É È Ì Ò Ù Ü " \\ \\ \\+)*

element **Residenza_Rappresentante_Type/NumCivico**

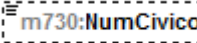
diagram	
namespace	urn:www.agenziaentrate.gov.it:specificheTecniche:sco:730
type	DatoAN_Type
facets	Kind Value pattern ([0-9A-Z-]*)"}{1}([0-9A-Z&:] ' - \., / ^\\(\\) À É È Ì Ò Ù Ü " \\ \\ \\+)*

element **Residenza_Rappresentante_Type/Frazione**

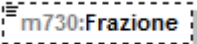
diagram	
namespace	urn:www.agenziaentrate.gov.it:specificheTecniche:sco:730
type	DatoAN_Type
facets	Kind Value pattern ([0-9A-Z-]*)"}{1}([0-9A-Z&:] ' - \., / ^\\(\\) À É È Ì Ò Ù Ü " \\ \\ \\+)*

complexType **Residenza_Type**

diagram	
namespace	urn:www.agenziaentrate.gov.it:specificheTecniche:sco:730
children	m730:Comune m730:Provincia m730:CodiceComune m730:Cap m730:Tipologia m730:Indirizzo m730:NumCivico m730:Frazione m730:Email m730:Telefono

element **Residenza_Type/Comune**

diagram					
namespace	urn:www.agenziaentrate.gov.it:specificheTecniche:sco:730				
type	DatoAN_Type				
facets	<table border="0"> <tr> <td>Kind</td> <td>Value</td> </tr> <tr> <td>pattern</td> <td>(([0-9A-Z-] \&quot;){1}([0-9A-Z&amp;:] \- \., / \^\(\ \)\ À È É Ì Ò Ù Û &quot; \ \\ /+)*</td> </tr> </table>	Kind	Value	pattern	(([0-9A-Z-] \"){1}([0-9A-Z&:] \- \., / \^\(\ \)\ À È É Ì Ò Ù Û " \ \\ /+)*
Kind	Value				
pattern	(([0-9A-Z-] \"){1}([0-9A-Z&:] \- \., / \^\(\ \)\ À È É Ì Ò Ù Û " \ \\ /+)*				

element **Residenza_Type/Provincia**

diagram	
namespace	urn:www.agenziaentrate.gov.it:specificheTecniche:sco:730
type	PR_Type

element **Residenza_Type/CodiceComune**

diagram	
namespace	urn:www.agenziaentrate.gov.it:specificheTecniche:sco:730

type	DatoAN_Type
facets	Kind Value pattern ([0-9A-Z\-_]"){1}([0-9A-Z&:] \- \., / ^ \^\(\ \)\ À É È Ì Ò Ù Û " \ \\ \ +)*

element **Residenza_Type/Cap**

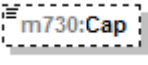
diagram	
namespace	urn:www.agenziaentrate.gov.it:specificheTecniche:sco:730
type	DatoAN_Type
facets	Kind Value pattern ([0-9A-Z\-_]"){1}([0-9A-Z&:] \- \., / ^ \^\(\ \)\ À É È Ì Ò Ù Û " \ \\ \ +)*

element **Residenza_Type/Tipologia**

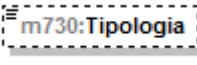
diagram	
namespace	urn:www.agenziaentrate.gov.it:specificheTecniche:sco:730
type	DatoAN_Type
facets	Kind Value pattern ([0-9A-Z\-_]"){1}([0-9A-Z&:] \- \., / ^ \^\(\ \)\ À É È Ì Ò Ù Û " \ \\ \ +)*

element **Residenza_Type/Indirizzo**

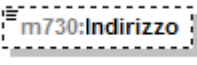
diagram	
namespace	urn:www.agenziaentrate.gov.it:specificheTecniche:sco:730
type	DatoAN_Type
facets	Kind Value pattern ([0-9A-Z\-_]"){1}([0-9A-Z&:] \- \., / ^ \^\(\ \)\ À É È Ì Ò Ù Û " \ \\ \ +)*

element **Residenza_Type/NumCivico**

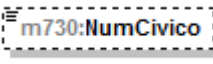
diagram	
namespace	urn:www.agenziaentrate.gov.it:specificheTecniche:sco:730
type	DatoAN_Type
facets	Kind Value pattern ([0-9A-Z\-_]"){1}([0-9A-Z&:] \- \., / ^ \^\(\ \)\ À É È Ì Ò Ù Û " \ \\ \ +)*

element **Residenza_Type/Frazione**

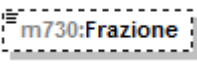
diagram	
namespace	urn:www.agenziaentrate.gov.it:specificheTecniche:sco:730

type	DatoAN_Type
facets	Kind Value pattern ([0-9A-Z\-\"]{1}([0-9A-Z&#92; \-\.\, / \^\(\ \)\ \À \É \Ì \Ò \Ù \Ü " \ \ +)*

element **Residenza_Type/Email**

diagram	
namespace	urn:www.agenziaentrate.gov.it:specificheTecniche:sco:730
type	DatoEM_Type
facets	Kind Value pattern [a-zA-Z0-9_\%"?^~=]+@[a-zA-Z0-9\-\.\, / \^\(\ \)\ \À \É \Ì \Ò \Ù \Ü " \ \ +)*

element **Residenza_Type/Telefono**

diagram	
namespace	urn:www.agenziaentrate.gov.it:specificheTecniche:sco:730
type	DatoAN_Type
facets	Kind Value pattern ([0-9A-Z\-\"]{1}([0-9A-Z&#92; \-\.\, / \^\(\ \)\ \À \É \Ì \Ò \Ù \Ü " \ \ +)*

complexType **Residuo_Credito_Compens_Annolmposta_Type**

diagram	
namespace	urn:www.agenziaentrate.gov.it:specificheTecniche:sco:730
type	extension of m730:Residuo_Credito_Compens_Type
children	m730:CreditoAnno m730:DiCuiCompensatoF24

complexType **Residuo_Credito_Compens_Type**

diagram	
namespace	urn:www.agenziaentrate.gov.it:specificheTecniche:sco:730
children	m730:CreditoAnno m730:DiCuiCompensatoF24

element **Residuo_Credito_Compens_Type/CreditoAnno**

diagram	
namespace	urn:www.agenziaentrate.gov.it:specificheTecniche:sco:730
type	DatoNP_Type
facets	Kind Value pattern [1-9]{1}[0-9]*

element **Residuo_Credito_Compens_Type/DiCuiCompensatoF24**

diagram	
namespace	urn:www.agenziaentrate.gov.it:specificheTecniche:sco:730
type	DatoNP_Type
facets	Kind Value pattern [1-9]{1}[0-9]*

complexType **Residuo_Fabbricati_Type**

diagram	
namespace	urn:www.agenziaentrate.gov.it:specificheTecniche:sco:730
children	m730:ResiduoPrecedenteDichiarazione m730:CreditoAnno m730:DiCuiCompensatoF24

element **Residuo_Fabbricati_Type/ResiduoPrecedenteDichiarazione**

diagram	
namespace	urn:www.agenziaentrate.gov.it:specificheTecniche:sco:730
type	DatoNP_Type
facets	Kind Value pattern [1-9]{1}[0-9]*

element **Residuo_Fabbricati_Type/CreditoAnno**

diagram	
namespace	urn:www.agenziaentrate.gov.it:specificheTecniche:sco:730
type	DatoNP_Type
facets	Kind Value pattern [1-9]{1}[0-9]*

element Residuo_Fabbricati_Type/DiCuiCompensatoF24

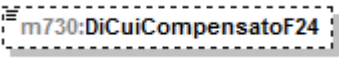
diagram	
namespace	urn:www.agenziaentrate.gov.it:specificheTecniche:sco:730
type	DatoNP_Type
facets	Kind Value pattern [1-9]{1}[0-9]*

complexType Restituzione_Somme_Type

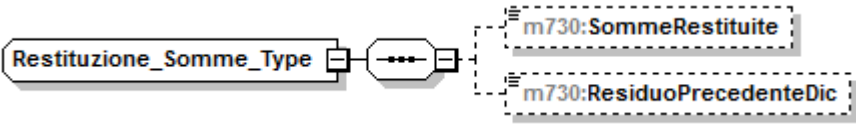
diagram	
namespace	urn:www.agenziaentrate.gov.it:specificheTecniche:sco:730
children	m730:SommeRestituite m730:ResiduoPrecedenteDic

element Restituzione_Somme_Type/SommeRestituite

diagram	
namespace	urn:www.agenziaentrate.gov.it:specificheTecniche:sco:730
type	DatoNP_Type
facets	Kind Value pattern [1-9]{1}[0-9]*

element Restituzione_Somme_Type/ResiduoPrecedenteDic

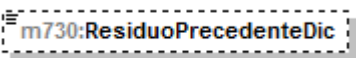
diagram	
namespace	urn:www.agenziaentrate.gov.it:specificheTecniche:sco:730
type	DatoNP_Type
facets	Kind Value pattern [1-9]{1}[0-9]*

complexType Rettifica_Type

diagram	
namespace	urn:www.agenziaentrate.gov.it:specificheTecniche:sco:730
children	m730:Quadro m730:Rigo m730:Colonna m730:Modulo m730:DatoRimosso

element Rettifica_Type/Quadro

diagram					
namespace	urn:www.agenziaentrate.gov.it:specificheTecniche:sco:730				
type	DatoAN_Type				
facets	<table border="1"> <tr> <td>Kind</td> <td>Value</td> </tr> <tr> <td>pattern</td> <td>([0-9A-Z-]*)&quot;}{1}([0-9A-Z&amp;:] ' - \., / ^*\(\) \) À É È Ò Ù Û &quot; \ \ /+)*</td> </tr> </table>	Kind	Value	pattern	([0-9A-Z-]*)"}{1}([0-9A-Z&:] ' - \., / ^*\(\) \) À É È Ò Ù Û " \ \ /+)*
Kind	Value				
pattern	([0-9A-Z-]*)"}{1}([0-9A-Z&:] ' - \., / ^*\(\) \) À É È Ò Ù Û " \ \ /+)*				

element Rettifica_Type/Rigo

diagram					
namespace	urn:www.agenziaentrate.gov.it:specificheTecniche:sco:730				
type	DatoNP_Type				
facets	<table border="1"> <tr> <td>Kind</td> <td>Value</td> </tr> <tr> <td>pattern</td> <td>[1-9]{1}[0-9]*</td> </tr> </table>	Kind	Value	pattern	[1-9]{1}[0-9]*
Kind	Value				
pattern	[1-9]{1}[0-9]*				

element Rettifica_Type/Colonna

diagram					
namespace	urn:www.agenziaentrate.gov.it:specificheTecniche:sco:730				
type	DatoNP_Type				
facets	<table border="1"> <tr> <td>Kind</td> <td>Value</td> </tr> <tr> <td>pattern</td> <td>[1-9]{1}[0-9]*</td> </tr> </table>	Kind	Value	pattern	[1-9]{1}[0-9]*
Kind	Value				
pattern	[1-9]{1}[0-9]*				

element Rettifica_Type/Modulo

diagram	
---------	--

namespace	urn:www.agenziaentrate.gov.it:specificheTecniche:sco:730
type	DatoNP_Type
facets	Kind Value pattern [1-9]{1}[0-9]*

element Rettifica_Type/DatoRimosso

diagram	
namespace	urn:www.agenziaentrate.gov.it:specificheTecniche:sco:730
type	DatoCB_Type
facets	Kind Value pattern [01]

complexType Riepilogo_Redditi_Type

diagram	
namespace	urn:www.agenziaentrate.gov.it:specificheTecniche:sco:730
children	m730:Dominicali m730:Agrari m730:Fabbricati m730:LavDip m730:AltriRedditi m730:ImponibileCedolare m730:ImponibileCedolareOrdinario m730:ImponibileCedolareAgevolato m730:AbitazionePrincipalePertinenze

element Riepilogo_Redditi_Type/Dominicali

diagram	
namespace	urn:www.agenziaentrate.gov.it:specificheTecniche:sco:730
type	DatoNP_Type
facets	Kind Value pattern [1-9]{1}[0-9]*

element Riepilogo_Redditi_Type/Agrari

diagram	
namespace	urn:www.agenziaentrate.gov.it:specificheTecniche:sco:730
type	DatoNP_Type
facets	Kind Value pattern [1-9]{1}[0-9]*

element Riepilogo_Redditi_Type/Fabbricati

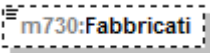
diagram	
namespace	urn:www.agenziaentrate.gov.it:specificheTecniche:sco:730
type	DatoNP_Type
facets	Kind Value pattern [1-9]{1}[0-9]*

element Riepilogo_Redditi_Type/LavDip

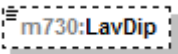
diagram	
namespace	urn:www.agenziaentrate.gov.it:specificheTecniche:sco:730
type	DatoNP_Type
facets	Kind Value pattern [1-9]{1}[0-9]*

element Riepilogo_Redditi_Type/AltriRedditi

diagram	
namespace	urn:www.agenziaentrate.gov.it:specificheTecniche:sco:730
type	DatoNP_Type
facets	Kind Value pattern [1-9]{1}[0-9]*

element Riepilogo_Redditi_Type/ImponibileCedolare

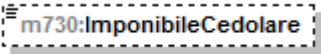
diagram	
namespace	urn:www.agenziaentrate.gov.it:specificheTecniche:sco:730
type	DatoNP_Type
facets	Kind Value pattern [1-9]{1}[0-9]*

element **Riepilogo_Reddi_Type/ImponibileCedolareOrdinario**

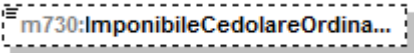
diagram	
namespace	urn:www.agenziaentrate.gov.it:specificheTecniche:sco:730
type	DatoNP_Type
facets	Kind Value pattern [1-9]{1}[0-9]*

element **Riepilogo_Reddi_Type/ImponibileCedolareAgevolato**

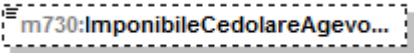
diagram	
namespace	urn:www.agenziaentrate.gov.it:specificheTecniche:sco:730
type	DatoNP_Type
facets	Kind Value pattern [1-9]{1}[0-9]*

element **Riepilogo_Reddi_Type/AbitazionePrincipalePertinenze**

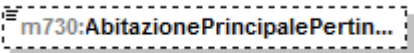
diagram	
namespace	urn:www.agenziaentrate.gov.it:specificheTecniche:sco:730
type	DatoNP_Type
facets	Kind Value pattern [1-9]{1}[0-9]*

complexType **Ritenute_Acconti_Sospesi_Type**

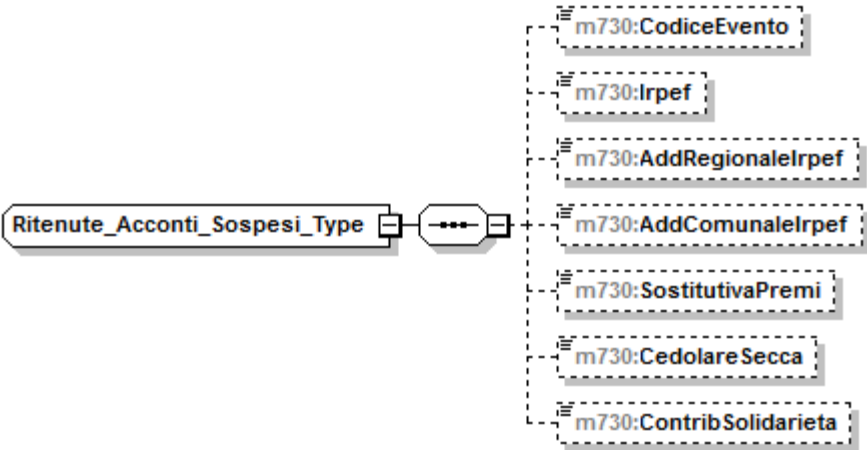
diagram	
namespace	urn:www.agenziaentrate.gov.it:specificheTecniche:sco:730
children	m730:CodiceEvento m730:lrpef m730:AddRegionalelrpef m730:AddComunalelrpef m730:SostitutivaPremi m730:CedolareSecca m730:ContribSolidarieta

element **Ritenute_Acconti_Sospesi_Type/CodiceEvento**

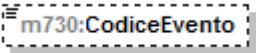
diagram																	
namespace	urn:www.agenziaentrate.gov.it:specificheTecniche:sco:730																
type	m730:Codice_Evento_Eccezionale_Type																
facets	<table border="0"> <tr> <td>Kind</td> <td>Value</td> </tr> <tr> <td>pattern</td> <td>[1-9]{1}[0-9]*</td> </tr> <tr> <td>enumeration</td> <td>1</td> </tr> <tr> <td>enumeration</td> <td>2</td> </tr> <tr> <td>enumeration</td> <td>3</td> </tr> <tr> <td>enumeration</td> <td>4</td> </tr> <tr> <td>enumeration</td> <td>5</td> </tr> <tr> <td>enumeration</td> <td>6</td> </tr> </table>	Kind	Value	pattern	[1-9]{1}[0-9]*	enumeration	1	enumeration	2	enumeration	3	enumeration	4	enumeration	5	enumeration	6
Kind	Value																
pattern	[1-9]{1}[0-9]*																
enumeration	1																
enumeration	2																
enumeration	3																
enumeration	4																
enumeration	5																
enumeration	6																

element **Ritenute_Acconti_Sospesi_Type/lrpef**

diagram					
namespace	urn:www.agenziaentrate.gov.it:specificheTecniche:sco:730				
type	DatoNP_Type				
facets	<table border="0"> <tr> <td>Kind</td> <td>Value</td> </tr> <tr> <td>pattern</td> <td>[1-9]{1}[0-9]*</td> </tr> </table>	Kind	Value	pattern	[1-9]{1}[0-9]*
Kind	Value				
pattern	[1-9]{1}[0-9]*				

element **Ritenute_Acconti_Sospesi_Type/AddRegionalelrpef**

diagram					
namespace	urn:www.agenziaentrate.gov.it:specificheTecniche:sco:730				
type	DatoNP_Type				
facets	<table border="0"> <tr> <td>Kind</td> <td>Value</td> </tr> <tr> <td>pattern</td> <td>[1-9]{1}[0-9]*</td> </tr> </table>	Kind	Value	pattern	[1-9]{1}[0-9]*
Kind	Value				
pattern	[1-9]{1}[0-9]*				

element **Ritenute_Acconti_Sospesi_Type/AddComunalelrpef**

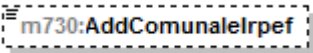
diagram					
namespace	urn:www.agenziaentrate.gov.it:specificheTecniche:sco:730				
type	DatoNP_Type				
facets	<table border="0"> <tr> <td>Kind</td> <td>Value</td> </tr> <tr> <td>pattern</td> <td>[1-9]{1}[0-9]*</td> </tr> </table>	Kind	Value	pattern	[1-9]{1}[0-9]*
Kind	Value				
pattern	[1-9]{1}[0-9]*				

element **Ritenute_Acconti_Sospesi_Type/SostitutivaPremi**

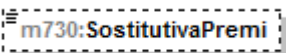
diagram	
namespace	urn:www.agenziaentrate.gov.it:specificheTecniche:sco:730

type	DatoNP_Type
facets	Kind Value pattern [1-9]{1}[0-9]*

element **Ritenute_Acconti_Sospesi_Type/CedolareSecca**

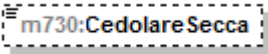
diagram	
namespace	urn:www.agenziaentrate.gov.it:specificheTecniche:sco:730
type	DatoNP_Type
facets	Kind Value pattern [1-9]{1}[0-9]*

element **Ritenute_Acconti_Sospesi_Type/ContribSolidarieta**

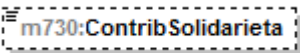
diagram	
namespace	urn:www.agenziaentrate.gov.it:specificheTecniche:sco:730
type	DatoNP_Type
facets	Kind Value pattern [1-9]{1}[0-9]*

complexType **Ritenute_Lavoro_Dip_Type**

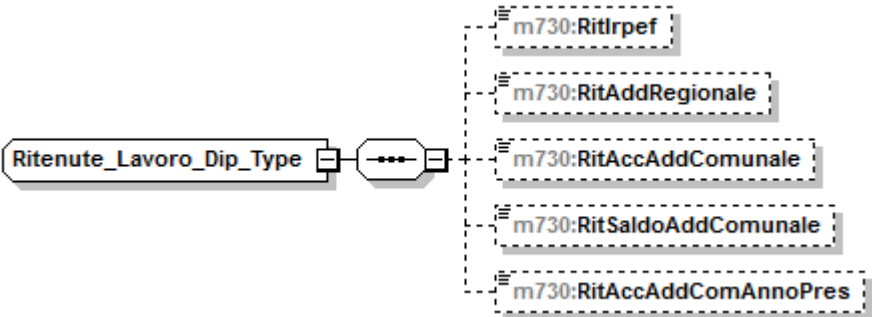
diagram	
namespace	urn:www.agenziaentrate.gov.it:specificheTecniche:sco:730
children	m730:Ritlrpef m730:RitAddRegionale m730:RitAccAddComunale m730:RitSaldoAddComunale m730:RitAccAddComAnnoPres

element **Ritenute_Lavoro_Dip_Type/Ritlrpef**

diagram	
namespace	urn:www.agenziaentrate.gov.it:specificheTecniche:sco:730
type	DatoNP_Type
facets	Kind Value pattern [1-9]{1}[0-9]*

element Ritenute_Lavoro_Dip_Type/RitAddRegionale

diagram	
namespace	urn:www.agenziaentrate.gov.it:specificheTecniche:sco:730
type	DatoNP_Type
facets	Kind Value pattern [1-9]{1}[0-9]*

element Ritenute_Lavoro_Dip_Type/RitAccAddComunale

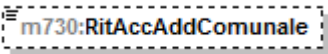
diagram	
namespace	urn:www.agenziaentrate.gov.it:specificheTecniche:sco:730
type	DatoNP_Type
facets	Kind Value pattern [1-9]{1}[0-9]*

element Ritenute_Lavoro_Dip_Type/RitSaldoAddComunale

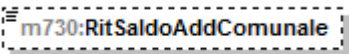
diagram	
namespace	urn:www.agenziaentrate.gov.it:specificheTecniche:sco:730
type	DatoNP_Type
facets	Kind Value pattern [1-9]{1}[0-9]*

element Ritenute_Lavoro_Dip_Type/RitAccAddComAnnoPres

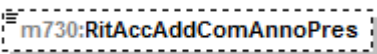
diagram	
namespace	urn:www.agenziaentrate.gov.it:specificheTecniche:sco:730
type	DatoNP_Type
facets	Kind Value pattern [1-9]{1}[0-9]*

complexType Sezione_Altri_Redd_Type

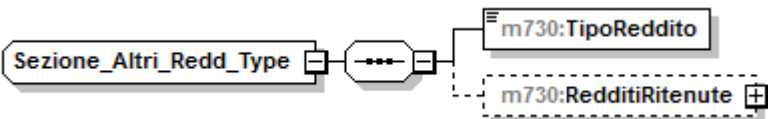
diagram	
namespace	urn:www.agenziaentrate.gov.it:specificheTecniche:sco:730
children	m730:TipoReddito m730:RedditiRitenute

element **Sezione_Altri_Redd_Type/TipoReddito**

diagram																					
namespace	urn:www.agenziaentrate.gov.it:specificheTecniche:sco:730																				
type	m730:Tipo_Reddito_Da1a8_Type																				
facets	<table border="1"> <thead> <tr> <th>Kind</th> <th>Value</th> </tr> </thead> <tbody> <tr> <td>pattern</td> <td>[1-9]{1}[0-9]*</td> </tr> <tr> <td>enumeration</td> <td>1</td> </tr> <tr> <td>enumeration</td> <td>2</td> </tr> <tr> <td>enumeration</td> <td>3</td> </tr> <tr> <td>enumeration</td> <td>4</td> </tr> <tr> <td>enumeration</td> <td>5</td> </tr> <tr> <td>enumeration</td> <td>6</td> </tr> <tr> <td>enumeration</td> <td>7</td> </tr> <tr> <td>enumeration</td> <td>8</td> </tr> </tbody> </table>	Kind	Value	pattern	[1-9]{1}[0-9]*	enumeration	1	enumeration	2	enumeration	3	enumeration	4	enumeration	5	enumeration	6	enumeration	7	enumeration	8
Kind	Value																				
pattern	[1-9]{1}[0-9]*																				
enumeration	1																				
enumeration	2																				
enumeration	3																				
enumeration	4																				
enumeration	5																				
enumeration	6																				
enumeration	7																				
enumeration	8																				

element **Sezione_Altri_Redd_Type/RedditiRitenute**

diagram	
namespace	urn:www.agenziaentrate.gov.it:specificheTecniche:sco:730
type	m730:Redditi_Ritenute_Type
children	m730:ImportoRedditi m730:ImportoRitenute

complexType **Sezione_Dati_Catastali_Recupero_Patrimonio_Edilizio_Type**

diagram	
namespace	urn:www.agenziaentrate.gov.it:specificheTecniche:sco:730
children	m730:DatiCatastaliRecuperoPatrimonioEdilizio m730:DatiRegistrazioneAccatastamentoRecuperoPatrimonio_Edilizio

element

Sezione Dati Catastali Recupero Patrimonio Edilizio Type/DatiCatastaliRecuperoPatrimonioEdilizio

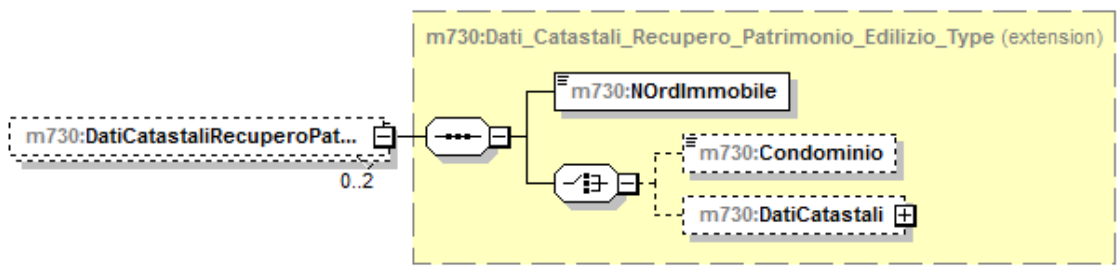
diagram	
namespace	urn:www.agenziaentrate.gov.it:specificheTecniche:sco:730
type	extension of m730:Dati Catastali Recupero Patrimonio Edilizio Type
children	m730:NOrdImmobile m730:Condominio m730:DatiCatastali

element

Sezione Dati Catastali Recupero Patrimonio Edilizio Type/DatiRegistrazioneAccatastamentoRecuperoPatrimonio Edilizio

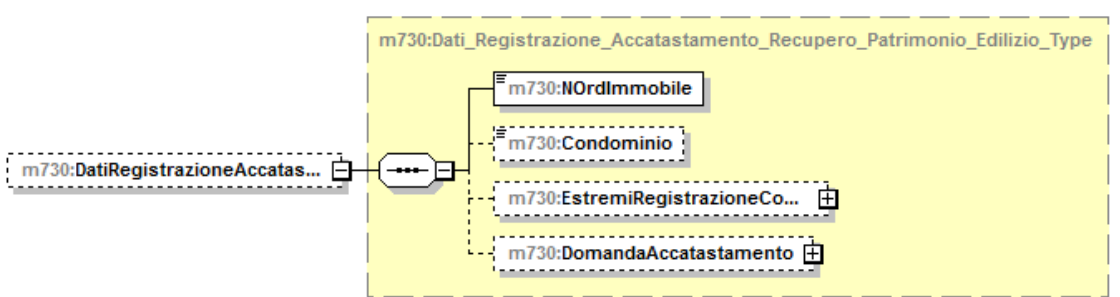
diagram	
namespace	urn:www.agenziaentrate.gov.it:specificheTecniche:sco:730
type	m730:Dati_Registrazione_Accatastamento_Recupero_Patrimonio_Edilizio_Type
children	m730:NOrdImmobile m730:Condominio m730:EstremiRegistrazioneContratto m730:DomandaAccatastamento

complexType Soggetto Assistenza Fiscale Doc Type

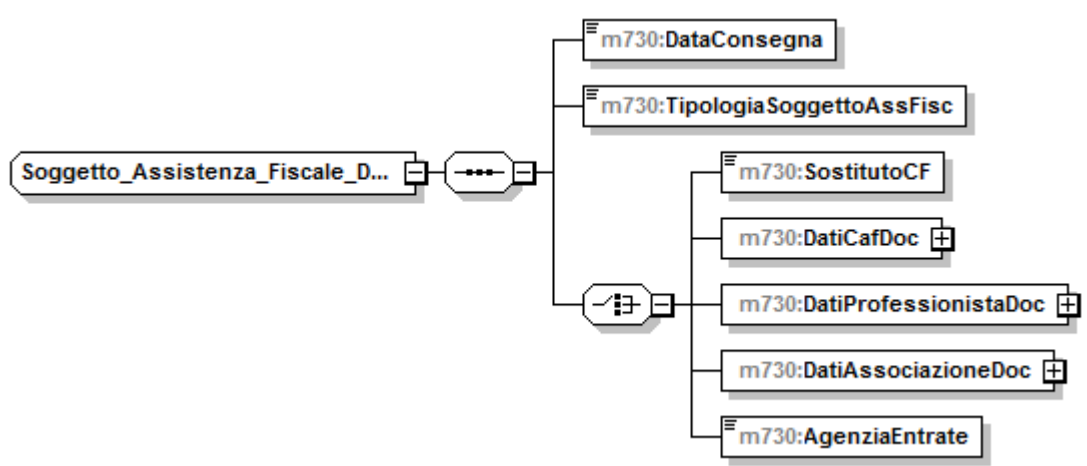
diagram	
---------	--

namespace	urn:www.agenziaentrate.gov.it:specificheTecniche:sco:730
children	m730:DataConsegna m730:TipologiaSoggettoAssFisc m730:SostitutoCF m730:DatiCafDoc m730:DatiProfessionistaDoc m730:DatiAssociazioneDoc m730:AgenziaEntrate

element **Soggetto_Assistenza_Fiscale_Doc_Type/DataConsegna**

diagram					
namespace	urn:www.agenziaentrate.gov.it:specificheTecniche:sco:730				
type	DatoDT_Type				
facets	<table border="1"> <thead> <tr> <th>Kind</th> <th>Value</th> </tr> </thead> <tbody> <tr> <td>pattern</td> <td>((([0-9]{12}[0-9]{3}[01])([0-9]{10}[12]{1}(\d{4}))) ([0-9]{12}[0-9]{30}([469]{11}(\d{4}))) ([0-9]{11}[0-9]{2}[0-8])([02]{1}(\d{4}))) ((29)(02)([02468]{048}00)) ((29)(02)([13579]{26}00)) ((29)(02)([0-9]{0-9}[0]{48})) ((29)(02)([0-9]{0-9}[2468]{048})) ((29)(02)([0-9]{0-9}[13579]{26})))</td> </tr> </tbody> </table>	Kind	Value	pattern	((([0-9]{12}[0-9]{3}[01])([0-9]{10}[12]{1}(\d{4}))) ([0-9]{12}[0-9]{30}([469]{11}(\d{4}))) ([0-9]{11}[0-9]{2}[0-8])([02]{1}(\d{4}))) ((29)(02)([02468]{048}00)) ((29)(02)([13579]{26}00)) ((29)(02)([0-9]{0-9}[0]{48})) ((29)(02)([0-9]{0-9}[2468]{048})) ((29)(02)([0-9]{0-9}[13579]{26})))
Kind	Value				
pattern	((([0-9]{12}[0-9]{3}[01])([0-9]{10}[12]{1}(\d{4}))) ([0-9]{12}[0-9]{30}([469]{11}(\d{4}))) ([0-9]{11}[0-9]{2}[0-8])([02]{1}(\d{4}))) ((29)(02)([02468]{048}00)) ((29)(02)([13579]{26}00)) ((29)(02)([0-9]{0-9}[0]{48})) ((29)(02)([0-9]{0-9}[2468]{048})) ((29)(02)([0-9]{0-9}[13579]{26})))				

element **Soggetto_Assistenza_Fiscale_Doc_Type/TipologiaSoggettoAssFisc**

diagram															
namespace	urn:www.agenziaentrate.gov.it:specificheTecniche:sco:730														
type	m730:Tipologia_Soggetto_Ass_Fisc_Type														
facets	<table border="1"> <thead> <tr> <th>Kind</th> <th>Value</th> </tr> </thead> <tbody> <tr> <td>pattern</td> <td>[1-9]</td> </tr> <tr> <td>enumeration</td> <td>1</td> </tr> <tr> <td>enumeration</td> <td>2</td> </tr> <tr> <td>enumeration</td> <td>3</td> </tr> <tr> <td>enumeration</td> <td>4</td> </tr> <tr> <td>enumeration</td> <td>5</td> </tr> </tbody> </table>	Kind	Value	pattern	[1-9]	enumeration	1	enumeration	2	enumeration	3	enumeration	4	enumeration	5
Kind	Value														
pattern	[1-9]														
enumeration	1														
enumeration	2														
enumeration	3														
enumeration	4														
enumeration	5														

element **Soggetto_Assistenza_Fiscale_Doc_Type/SostitutoCF**

diagram					
namespace	urn:www.agenziaentrate.gov.it:specificheTecniche:sco:730				
type	DatoCF_Type				
facets	<table border="1"> <thead> <tr> <th>Kind</th> <th>Value</th> </tr> </thead> <tbody> <tr> <td>pattern</td> <td>[0-9]{11}[A-Z]{6}[0-9LMNPQRSTU]{2}[A-Z]{1}[0-9LMNPQRSTU]{2}[A-Z]{1}[0-9LMNPQRSTU]{3}[A-Z]{1}</td> </tr> </tbody> </table>	Kind	Value	pattern	[0-9]{11}[A-Z]{6}[0-9LMNPQRSTU]{2}[A-Z]{1}[0-9LMNPQRSTU]{2}[A-Z]{1}[0-9LMNPQRSTU]{3}[A-Z]{1}
Kind	Value				
pattern	[0-9]{11}[A-Z]{6}[0-9LMNPQRSTU]{2}[A-Z]{1}[0-9LMNPQRSTU]{2}[A-Z]{1}[0-9LMNPQRSTU]{3}[A-Z]{1}				

element **Soggetto_Assistenza_Fiscale_Doc_Type/DatiCafDoc**

diagram	
namespace	urn:www.agenziaentrate.gov.it:specificheTecniche:sco:730
type	extension of m730:Dati_CAF_Type
children	m730:CFCaf m730:DenominazioneCaf m730:NumeroAlbo m730:CFResponsabile m730:CognomeResponsabile m730:NomeResponsabile m730:CF Soc Servizi m730:Id Sede Periferica m730:Casella Attestazione Caf

element **Soggetto_Assistenza_Fiscale_Doc_Type/DatiCafDoc/CFResponsabile**

diagram					
namespace	urn:www.agenziaentrate.gov.it:specificheTecniche:sco:730				
type	DatoCF_Type				
facets	<table border="1"> <thead> <tr> <th>Kind</th> <th>Value</th> </tr> </thead> <tbody> <tr> <td>pattern</td> <td>[0-9]{11}[A-Z]{6}[0-9LMNPQRSTU]{2}[A-Z]{1}[0-9LMNPQRSTU]{2}[A-Z]{1}[0-9LMNPQRSTU]{3}[A-Z]{1}</td> </tr> </tbody> </table>	Kind	Value	pattern	[0-9]{11}[A-Z]{6}[0-9LMNPQRSTU]{2}[A-Z]{1}[0-9LMNPQRSTU]{2}[A-Z]{1}[0-9LMNPQRSTU]{3}[A-Z]{1}
Kind	Value				
pattern	[0-9]{11}[A-Z]{6}[0-9LMNPQRSTU]{2}[A-Z]{1}[0-9LMNPQRSTU]{2}[A-Z]{1}[0-9LMNPQRSTU]{3}[A-Z]{1}				

element **Soggetto_Assistenza_Fiscale_Doc_Type/DatiCafDoc/CognomeResponsabile**

diagram					
namespace	urn:www.agenziaentrate.gov.it:specificheTecniche:sco:730				
type	DatoAN_Type				
facets	<table border="1"> <thead> <tr> <th>Kind</th> <th>Value</th> </tr> </thead> <tbody> <tr> <td>pattern</td> <td>(([0-9A-Z-] \&quot;){1}([0-9A-Z&amp;#39; \- \., / \°\^\(\)\À É È Ì Ò Ù Û &quot; \N \+)*</td> </tr> </tbody> </table>	Kind	Value	pattern	(([0-9A-Z-] \"){1}([0-9A-Z&#39; \- \., / \°\^\(\)\À É È Ì Ò Ù Û " \N \+)*
Kind	Value				
pattern	(([0-9A-Z-] \"){1}([0-9A-Z&#39; \- \., / \°\^\(\)\À É È Ì Ò Ù Û " \N \+)*				

element **Soggetto_Assistenza_Fiscale_Doc_Type/DatiCafDoc/NomeResponsabile**

diagram					
namespace	urn:www.agenziaentrate.gov.it:specificheTecniche:sco:730				
type	DatoAN_Type				
facets	<table border="1"> <tr> <td>Kind</td> <td>Value</td> </tr> <tr> <td>pattern</td> <td>(([0-9A-Z\-\-]&quot;){1}([0-9A-Z&amp;:] '\-\-\. / °\^\(\)\) À É È Ì Ò Ù Û &quot; \ \ /+)*</td> </tr> </table>	Kind	Value	pattern	(([0-9A-Z\-\-]"){1}([0-9A-Z&:] '\-\-\. / °\^\(\)\) À É È Ì Ò Ù Û " \ \ /+)*
Kind	Value				
pattern	(([0-9A-Z\-\-]"){1}([0-9A-Z&:] '\-\-\. / °\^\(\)\) À É È Ì Ò Ù Û " \ \ /+)*				

element **Soggetto_Assistenza_Fiscale_Doc_Type/DatiCafDoc/CF Soc Servizi**

diagram					
namespace	urn:www.agenziaentrate.gov.it:specificheTecniche:sco:730				
type	DatoCN_Type				
facets	<table border="1"> <tr> <td>Kind</td> <td>Value</td> </tr> <tr> <td>pattern</td> <td>[0-9]{11}</td> </tr> </table>	Kind	Value	pattern	[0-9]{11}
Kind	Value				
pattern	[0-9]{11}				

element **Soggetto_Assistenza_Fiscale_Doc_Type/DatiCafDoc/IdSedePeriferica**

diagram					
namespace	urn:www.agenziaentrate.gov.it:specificheTecniche:sco:730				
type	DatoAN_Type				
facets	<table border="1"> <tr> <td>Kind</td> <td>Value</td> </tr> <tr> <td>pattern</td> <td>(([0-9A-Z\-\-]&quot;){1}([0-9A-Z&amp;:] '\-\-\. / °\^\(\)\) À É È Ì Ò Ù Û &quot; \ \ /+)*</td> </tr> </table>	Kind	Value	pattern	(([0-9A-Z\-\-]"){1}([0-9A-Z&:] '\-\-\. / °\^\(\)\) À É È Ì Ò Ù Û " \ \ /+)*
Kind	Value				
pattern	(([0-9A-Z\-\-]"){1}([0-9A-Z&:] '\-\-\. / °\^\(\)\) À É È Ì Ò Ù Û " \ \ /+)*				

element **Soggetto_Assistenza_Fiscale_Doc_Type/DatiCafDoc/CasellaAttestazioneCaf**

diagram					
namespace	urn:www.agenziaentrate.gov.it:specificheTecniche:sco:730				
type	DatoCB_Type				
facets	<table border="1"> <tr> <td>Kind</td> <td>Value</td> </tr> <tr> <td>pattern</td> <td>[01]</td> </tr> </table>	Kind	Value	pattern	[01]
Kind	Value				
pattern	[01]				

element **Soggetto_Assistenza_Fiscale_Doc_Type/DatiProfessionistaDoc**

diagram	
namespace	urn:www.agenziaentrate.gov.it:specificheTecniche:sco:730
type	extension of m730:Dati Professionista Type
children	m730:CFProfessionista m730:CognomeProfessionista m730:NomeProfessionista m730:DatiNascitaProfessionista

element **Soggetto_Assistenza_Fiscale_Doc_Type/DatiProfessionistaDoc/DatiNascitaProfessionista**

diagram	
namespace	urn:www.agenziaentrate.gov.it:specificheTecniche:sco:730
type	m730:Dati_Nascita_PF_Type
children	m730:Sesso m730:DataNascita m730:ComuneNascita m730:ProvinciaNascita

element **Soggetto_Assistenza_Fiscale_Doc_Type/DatiAssociazioneDoc**

diagram	
namespace	urn:www.agenziaentrate.gov.it:specificheTecniche:sco:730
type	extension of m730:Dati_Associazioni_Professionale_Type
children	m730:CFAssociazione m730:DenominazioneAssociazione m730:CFProfessionista m730:CognomeProfessionista m730:NomeProfessionista m730:DatiNascitaProfessionista

element **Soggetto_Assistenza_Fiscale_Doc_Type/DatiAssociazioneDoc/DatiNascitaProfessionista**

diagram	
namespace	urn:www.agenziaentrate.gov.it:specificheTecniche:sco:730
type	m730:Dati_Nascita_PF_Type
children	m730:Sesso m730:DataNascita m730:ComuneNascita m730:ProvinciaNascita

element **Soggetto_Assistenza_Fiscale_Doc_Type/AgenziaEntrate**

diagram					
namespace	urn:www.agenziaentrate.gov.it:specificheTecniche:sco:730				
type	DatoCB_Type				
facets	<table border="1"> <tr> <td>Kind</td> <td>Value</td> </tr> <tr> <td>pattern</td> <td>[01]</td> </tr> </table>	Kind	Value	pattern	[01]
Kind	Value				
pattern	[01]				

complexType **Soggetto_Fiscale_730_Type**

diagram	
namespace	urn:www.agenziaentrate.gov.it:specificheTecniche:sco:730
children	m730:CodiceFiscale m730:Email m730:Telefono m730:Cellulare

element **Soggetto_Fiscale_730_Type/CodiceFiscale**

diagram					
namespace	urn:www.agenziaentrate.gov.it:specificheTecniche:sco:730				
type	DatoCF_Type				
facets	<table border="0"> <tr> <td>Kind</td> <td>Value</td> </tr> <tr> <td>pattern</td> <td>[0-9]{11}[A-Z]{6}[0-9LMNPQRSTUUV]{2}[A-Z]{1}[0-9LMNPQRSTUUV]{2}[A-Z]{1}[0-9LMNPQRSTUUV]{3}[A-Z]{1}</td> </tr> </table>	Kind	Value	pattern	[0-9]{11}[A-Z]{6}[0-9LMNPQRSTUUV]{2}[A-Z]{1}[0-9LMNPQRSTUUV]{2}[A-Z]{1}[0-9LMNPQRSTUUV]{3}[A-Z]{1}
Kind	Value				
pattern	[0-9]{11}[A-Z]{6}[0-9LMNPQRSTUUV]{2}[A-Z]{1}[0-9LMNPQRSTUUV]{2}[A-Z]{1}[0-9LMNPQRSTUUV]{3}[A-Z]{1}				

element **Soggetto_Fiscale_730_Type/Email**

diagram					
namespace	urn:www.agenziaentrate.gov.it:specificheTecniche:sco:730				
type	DatoEM_Type				
facets	<table border="0"> <tr> <td>Kind</td> <td>Value</td> </tr> <tr> <td>pattern</td> <td>[a-zA-Z0-9_%\-'&quot;?^~=]+@[a-zA-Z0-9\.\+\.[a-zA-Z]{2,4}</td> </tr> </table>	Kind	Value	pattern	[a-zA-Z0-9_%\-'"?^~=]+@[a-zA-Z0-9\.\+\.[a-zA-Z]{2,4}
Kind	Value				
pattern	[a-zA-Z0-9_%\-'"?^~=]+@[a-zA-Z0-9\.\+\.[a-zA-Z]{2,4}				

element **Soggetto_Fiscale_730_Type/Telefono**

diagram					
namespace	urn:www.agenziaentrate.gov.it:specificheTecniche:sco:730				
type	DatoAN_Type				
facets	<table border="0"> <tr> <td>Kind</td> <td>Value</td> </tr> <tr> <td>pattern</td> <td>([0-9A-Z\-\&quot;]{1})([0-9A-Z&amp;#39; \- \., / \°\^\(\)\ À É È Ì Ò Ù Û Ü&quot;; \\ / \+)*</td> </tr> </table>	Kind	Value	pattern	([0-9A-Z\-\"]{1})([0-9A-Z&#39; \- \., / \°\^\(\)\ À É È Ì Ò Ù Û Ü"; \\ / \+)*
Kind	Value				
pattern	([0-9A-Z\-\"]{1})([0-9A-Z&#39; \- \., / \°\^\(\)\ À É È Ì Ò Ù Û Ü"; \\ / \+)*				

element **Soggetto_Fiscale_730_Type/Cellulare**

diagram	
namespace	urn:www.agenziaentrate.gov.it:specificheTecniche:sco:730

type	DatoAN_Type
facets	Kind Value pattern ([0-9A-Z\-_]"){1}([0-9A-Z&:] \- \., / \^\(\ \) À É È Ì Ò Ù Û " \ \ / +)*

complexType **Soglie_Esenzione_Type**

diagram	
namespace	urn:www.agenziaentrate.gov.it:specificheTecniche:sco:730
children	m730:SogliaEsenzione m730:EsenzioneTotale

element **Soglie_Esenzione_Type/SogliaEsenzione**

diagram	
namespace	urn:www.agenziaentrate.gov.it:specificheTecniche:sco:730
type	DatoNP_Type
facets	Kind Value pattern [1-9]{1}[0-9]*

element **Soglie_Esenzione_Type/EsenzioneTotale**

diagram	
namespace	urn:www.agenziaentrate.gov.it:specificheTecniche:sco:730
type	restriction of DatoN1_Type
facets	Kind Value pattern [1-9] enumeration 1 enumeration 2

complexType **Sostituto_Type**

diagram	
---------	--

namespace	urn:www.agenziaentrate.gov.it:specificheTecniche:sco:730
children	m730:CodiceFiscale m730:DatiAnagraficiPF m730:DenominazionePNF m730:Residenza m730:Fax m730:CodiceSede

element Sostituto_Type/CodiceFiscale

diagram	
namespace	urn:www.agenziaentrate.gov.it:specificheTecniche:sco:730
type	DatoCF_Type
facets	Kind Value pattern [0-9]{11}[[A-Z]{6}[0-9LMNPQRSTU]{2}[A-Z]{1}[0-9LMNPQRSTU]{2}[A-Z]{1}[0-9LMNPQRSTU]{3}[A-Z]{1}

element Sostituto_Type/DatiAnagraficiPF

diagram	
namespace	urn:www.agenziaentrate.gov.it:specificheTecniche:sco:730
children	m730:Cognome m730:Nome

element Sostituto_Type/DatiAnagraficiPF/Cognome

diagram	
namespace	urn:www.agenziaentrate.gov.it:specificheTecniche:sco:730
type	DatoAN_Type
facets	Kind Value pattern ([0-9A-Z\-\"]{1}([0-9A-Z&] \- \., / \° \^ \(\) À È É Ì Ò Ù Û " \ \\ \+)*

element Sostituto_Type/DatiAnagraficiPF/Nome

diagram	
namespace	urn:www.agenziaentrate.gov.it:specificheTecniche:sco:730
type	DatoAN_Type
facets	Kind Value pattern ([0-9A-Z\-\"]{1}([0-9A-Z&] \- \., / \° \^ \(\) À È É Ì Ò Ù Û " \ \\ \+)*

element Sostituto_Type/DenominazionePNF

diagram	
---------	--

namespace	urn:www.agenziaentrate.gov.it:specificheTecniche:sco:730
type	DatoAN_Type
facets	Kind Value pattern ([0-9A-Z-] \"){1}([0-9A-Z&#39; ! ~ \- _ / ° ^\(\\(\) À É È Ì Ò Ù Û " \\ / +)*

element **Sostituto_Type/Residenza**

diagram	
namespace	urn:www.agenziaentrate.gov.it:specificheTecniche:sco:730
type	m730:Residenza_Type
children	m730:Comune m730:Provincia m730:CodiceComune m730:Cap m730:Tipologia m730:Indirizzo m730:NumCivico m730:Frazione m730:Email m730:Telefono

element **Sostituto_Type/Fax**

diagram	
namespace	urn:www.agenziaentrate.gov.it:specificheTecniche:sco:730
type	DatoAN_Type
facets	Kind Value pattern ([0-9A-Z-] \"){1}([0-9A-Z&#39; ! ~ \- _ / ° ^\(\\(\) À É È Ì Ò Ù Û " \\ / +)*

element **Sostituto_Type/CodiceSede**

diagram	
---------	--

namespace	urn:www.agenziaentrate.gov.it:specificheTecniche:sco:730				
type	DatoAN_Type				
facets	<table border="1"> <tr> <td>Kind</td> <td>Value</td> </tr> <tr> <td>pattern</td> <td>([0-9A-Z\-_]\&quot;){1}([0-9A-Z&amp;:] ! - \. , / ^ \^\(\ \)\ À É È Ì Ò Ù Ú &quot; \ \\ \ +)*</td> </tr> </table>	Kind	Value	pattern	([0-9A-Z\-_]\"){1}([0-9A-Z&:] ! - \. , / ^ \^\(\ \)\ À É È Ì Ò Ù Ú " \ \\ \ +)*
Kind	Value				
pattern	([0-9A-Z\-_]\"){1}([0-9A-Z&:] ! - \. , / ^ \^\(\ \)\ À É È Ì Ò Ù Ú " \ \\ \ +)*				

complexType **Spese_Arredo_Giovani_Coppie_Type**

diagram	
namespace	urn:www.agenziaentrate.gov.it:specificheTecniche:sco:730
children	m730:Meno35Anni m730:NumeroRata m730:Importo

element **Spese_Arredo_Giovani_Coppie_Type/Meno35Anni**

diagram					
namespace	urn:www.agenziaentrate.gov.it:specificheTecniche:sco:730				
type	DatoCB_Type				
facets	<table border="1"> <tr> <td>Kind</td> <td>Value</td> </tr> <tr> <td>pattern</td> <td>[01]</td> </tr> </table>	Kind	Value	pattern	[01]
Kind	Value				
pattern	[01]				

element **Spese_Arredo_Giovani_Coppie_Type/NumeroRata**

diagram							
namespace	urn:www.agenziaentrate.gov.it:specificheTecniche:sco:730						
type	restriction of DatoNP_Type						
facets	<table border="1"> <tr> <td>Kind</td> <td>Value</td> </tr> <tr> <td>pattern</td> <td>[1-9]{1}[0-9]*</td> </tr> <tr> <td>enumeration</td> <td>1</td> </tr> </table>	Kind	Value	pattern	[1-9]{1}[0-9]*	enumeration	1
Kind	Value						
pattern	[1-9]{1}[0-9]*						
enumeration	1						

element **Spese_Arredo_Giovani_Coppie_Type/Importo**

diagram					
namespace	urn:www.agenziaentrate.gov.it:specificheTecniche:sco:730				
type	DatoNP_Type				
facets	<table border="1"> <tr> <td>Kind</td> <td>Value</td> </tr> <tr> <td>pattern</td> <td>[1-9]{1}[0-9]*</td> </tr> </table>	Kind	Value	pattern	[1-9]{1}[0-9]*
Kind	Value				
pattern	[1-9]{1}[0-9]*				

complexType Spese_Arredo_Type

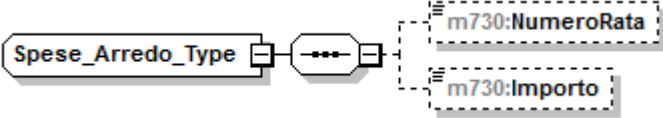
diagram	
namespace	urn:www.agenziaentrate.gov.it:specificheTecniche:sco:730
children	m730:NumeroRata m730:Importo

element Spese_Arredo_Type/NumeroRata

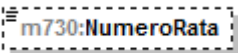
diagram													
namespace	urn:www.agenziaentrate.gov.it:specificheTecniche:sco:730												
type	restriction of DatoNP_Type												
facets	<table border="1"> <thead> <tr> <th>Kind</th> <th>Value</th> </tr> </thead> <tbody> <tr> <td>pattern</td> <td>[1-9]{1}[0-9]*</td> </tr> <tr> <td>enumeration</td> <td>1</td> </tr> <tr> <td>enumeration</td> <td>2</td> </tr> <tr> <td>enumeration</td> <td>3</td> </tr> <tr> <td>enumeration</td> <td>4</td> </tr> </tbody> </table>	Kind	Value	pattern	[1-9]{1}[0-9]*	enumeration	1	enumeration	2	enumeration	3	enumeration	4
Kind	Value												
pattern	[1-9]{1}[0-9]*												
enumeration	1												
enumeration	2												
enumeration	3												
enumeration	4												

element Spese_Arredo_Type/Importo

diagram					
namespace	urn:www.agenziaentrate.gov.it:specificheTecniche:sco:730				
type	DatoNP_Type				
facets	<table border="1"> <thead> <tr> <th>Kind</th> <th>Value</th> </tr> </thead> <tbody> <tr> <td>pattern</td> <td>[1-9]{1}[0-9]*</td> </tr> </tbody> </table>	Kind	Value	pattern	[1-9]{1}[0-9]*
Kind	Value				
pattern	[1-9]{1}[0-9]*				

complexType Spese_Leasing_Type

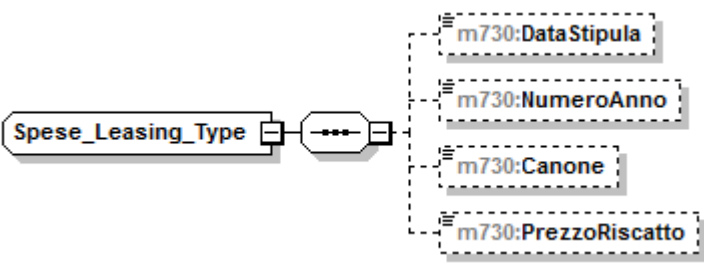
diagram	
namespace	urn:www.agenziaentrate.gov.it:specificheTecniche:sco:730
children	m730:DataStipula m730:NumeroAnno m730:Canone m730:PrezzoRiscatto

element **Spese_Leasing_Type/DataStipula**

diagram					
namespace	urn:www.agenziaentrate.gov.it:specificheTecniche:sco:730				
type	DatoDT_Type				
facets	<table border="1"> <thead> <tr> <th>Kind</th> <th>Value</th> </tr> </thead> <tbody> <tr> <td>pattern</td> <td>((([0-9]{1,12}[0-9]{3}[01])(0[13578]10 12)\d{4})) ((([0-9]{1,12}[0-9]{30}(0[469]11)\d{4})) ((([0-9]{1,12}[0-9]{2}[0-8])(02)\d{4})) ((29)(02)([02468][048]00)) ((29)(02)([13579][26]00)) ((29)(02)([0-9][0-9][0][48])) ((29)(02)([0-9][0-9][2468][048])) ((29)(02)([0-9][0-9][13579][26]))))</td> </tr> </tbody> </table>	Kind	Value	pattern	((([0-9]{1,12}[0-9]{3}[01])(0[13578]10 12)\d{4})) ((([0-9]{1,12}[0-9]{30}(0[469]11)\d{4})) ((([0-9]{1,12}[0-9]{2}[0-8])(02)\d{4})) ((29)(02)([02468][048]00)) ((29)(02)([13579][26]00)) ((29)(02)([0-9][0-9][0][48])) ((29)(02)([0-9][0-9][2468][048])) ((29)(02)([0-9][0-9][13579][26]))))
Kind	Value				
pattern	((([0-9]{1,12}[0-9]{3}[01])(0[13578]10 12)\d{4})) ((([0-9]{1,12}[0-9]{30}(0[469]11)\d{4})) ((([0-9]{1,12}[0-9]{2}[0-8])(02)\d{4})) ((29)(02)([02468][048]00)) ((29)(02)([13579][26]00)) ((29)(02)([0-9][0-9][0][48])) ((29)(02)([0-9][0-9][2468][048])) ((29)(02)([0-9][0-9][13579][26]))))				

element **Spese_Leasing_Type/NumeroAnno**

diagram							
namespace	urn:www.agenziaentrate.gov.it:specificheTecniche:sco:730						
type	restriction of DatoNP_Type						
facets	<table border="1"> <thead> <tr> <th>Kind</th> <th>Value</th> </tr> </thead> <tbody> <tr> <td>pattern</td> <td>[1-9]{1}[0-9]*</td> </tr> <tr> <td>enumeration</td> <td>1</td> </tr> </tbody> </table>	Kind	Value	pattern	[1-9]{1}[0-9]*	enumeration	1
Kind	Value						
pattern	[1-9]{1}[0-9]*						
enumeration	1						

element **Spese_Leasing_Type/Canone**

diagram					
namespace	urn:www.agenziaentrate.gov.it:specificheTecniche:sco:730				
type	restriction of DatoNP_Type				
facets	<table border="1"> <thead> <tr> <th>Kind</th> <th>Value</th> </tr> </thead> <tbody> <tr> <td>pattern</td> <td>[1-9]{1}[0-9]*</td> </tr> </tbody> </table>	Kind	Value	pattern	[1-9]{1}[0-9]*
Kind	Value				
pattern	[1-9]{1}[0-9]*				

element **Spese_Leasing_Type/PrezzoRiscatto**

diagram					
namespace	urn:www.agenziaentrate.gov.it:specificheTecniche:sco:730				
type	restriction of DatoNP_Type				
facets	<table border="1"> <thead> <tr> <th>Kind</th> <th>Value</th> </tr> </thead> <tbody> <tr> <td>pattern</td> <td>[1-9]{1}[0-9]*</td> </tr> </tbody> </table>	Kind	Value	pattern	[1-9]{1}[0-9]*
Kind	Value				
pattern	[1-9]{1}[0-9]*				

complexType **Spese_Rateizzate_Anni_Precedenti_Type**

diagram	
namespace	urn:www.agenziaentrate.gov.it:specificheTecniche:sco:730
children	m730:Codice m730:Importo

element **Spese_Rateizzate_Anni_Precedenti_Type/Codice**

diagram											
namespace	urn:www.agenziaentrate.gov.it:specificheTecniche:sco:730										
type	m730:Codice Spese Rateizzate Anni Precedenti Type										
facets	<table border="0"> <tr> <td>Kind</td> <td>Value</td> </tr> <tr> <td>pattern</td> <td>[1-9]{1}[0-9]*</td> </tr> <tr> <td>enumeration</td> <td>2</td> </tr> <tr> <td>enumeration</td> <td>3</td> </tr> <tr> <td>enumeration</td> <td>4</td> </tr> </table>	Kind	Value	pattern	[1-9]{1}[0-9]*	enumeration	2	enumeration	3	enumeration	4
Kind	Value										
pattern	[1-9]{1}[0-9]*										
enumeration	2										
enumeration	3										
enumeration	4										

element **Spese_Rateizzate_Anni_Precedenti_Type/Importo**

diagram					
namespace	urn:www.agenziaentrate.gov.it:specificheTecniche:sco:730				
type	DatoNP Type				
facets	<table border="0"> <tr> <td>Kind</td> <td>Value</td> </tr> <tr> <td>pattern</td> <td>[1-9]{1}[0-9]*</td> </tr> </table>	Kind	Value	pattern	[1-9]{1}[0-9]*
Kind	Value				
pattern	[1-9]{1}[0-9]*				

complexType **Spese_Rateizzate_Type**

diagram	
namespace	urn:www.agenziaentrate.gov.it:specificheTecniche:sco:730
children	m730:Codice m730:Importo

element **Spese_Rateizzate_Type/Codice**

diagram													
namespace	urn:www.agenziaentrate.gov.it:specificheTecniche:sco:730												
type	m730:Codice Spese Rateizzate Type												
facets	<table border="0"> <tr> <td>Kind</td> <td>Value</td> </tr> <tr> <td>pattern</td> <td>[1-9]{1}[0-9]*</td> </tr> <tr> <td>enumeration</td> <td>1</td> </tr> <tr> <td>enumeration</td> <td>2</td> </tr> <tr> <td>enumeration</td> <td>3</td> </tr> <tr> <td>enumeration</td> <td>4</td> </tr> </table>	Kind	Value	pattern	[1-9]{1}[0-9]*	enumeration	1	enumeration	2	enumeration	3	enumeration	4
Kind	Value												
pattern	[1-9]{1}[0-9]*												
enumeration	1												
enumeration	2												
enumeration	3												
enumeration	4												

element **Spese_Rateizzate_Type/Importo**

diagram	
namespace	urn:www.agenziaentrate.gov.it:specificheTecniche:sco:730
type	DatoNP_Type
facets	Kind Value pattern [1-9]{1}[0-9]*

complexType **Tassazione_Separata_Type**

diagram	
namespace	urn:www.agenziaentrate.gov.it:specificheTecniche:sco:730
children	m730:Opzione m730:Anno m730:RedditoRitenute

element **Tassazione_Separata_Type/Opzione**

diagram	
namespace	urn:www.agenziaentrate.gov.it:specificheTecniche:sco:730
type	DatoCB_Type
facets	Kind Value pattern [01]

element **Tassazione_Separata_Type/Anno**

diagram	
namespace	urn:www.agenziaentrate.gov.it:specificheTecniche:sco:730
type	DatoDA_Type
facets	Kind Value pattern (18 19 20)[0-9]{2}

element **Tassazione_Separata_Type/RedditoRitenute**

diagram	
---------	--

namespace	urn:www.agenziaentrate.gov.it:specificheTecniche:sco:730
type	m730:Redditi Ritenute Type
children	m730:ImportoRedditi m730:ImportoRitenute

complexType Terreno_Type

diagram	
namespace	urn:www.agenziaentrate.gov.it:specificheTecniche:sco:730
children	m730:RedDominicale m730:Titolo m730:RedAgrario m730:GiorniPossesso m730:PercPossesso m730:CanoneVincolistico m730:CasiParticolari m730:CasellaContinuazione m730:CasellalmuNonDovuta m730:CasellaColtivatoreDiretto

element Terreno_Type/RedDominicale

diagram					
namespace	urn:www.agenziaentrate.gov.it:specificheTecniche:sco:730				
type	DatoNP Type				
facets	<table border="1"> <thead> <tr> <th>Kind</th> <th>Value</th> </tr> </thead> <tbody> <tr> <td>pattern</td> <td>[1-9]{1}[0-9]*</td> </tr> </tbody> </table>	Kind	Value	pattern	[1-9]{1}[0-9]*
Kind	Value				
pattern	[1-9]{1}[0-9]*				

element Terreno_Type/Titolo

diagram	
namespace	urn:www.agenziaentrate.gov.it:specificheTecniche:sco:730
type	m730:Titolo Terreno_Type

facets	Kind	Value
	pattern	[1-9]{1}[0-9]*
	enumeration	1
	enumeration	2
	enumeration	3
	enumeration	4
	enumeration	5
	enumeration	6
	enumeration	7
	enumeration	10

element Terreno_Type/RedAgrario

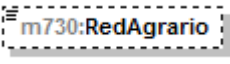
diagram	
namespace	urn:www.agenziaentrate.gov.it:specificheTecniche:sco:730
type	DatoNP_Type
facets	Kind Value pattern [1-9]{1}[0-9]*

element Terreno_Type/GiorniPossesso

diagram	
namespace	urn:www.agenziaentrate.gov.it:specificheTecniche:sco:730
type	DatoGA_Type
facets	Kind Value pattern [1-9](((1-9)[0-9]) ((12)[0-9][0-9]) (3[0-5][0-9]) (36[0-5]))

element Terreno_Type/PercPossesso

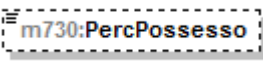
diagram	
namespace	urn:www.agenziaentrate.gov.it:specificheTecniche:sco:730
type	DatoPC_Type
facets	Kind Value pattern [0-9]?[0-9](,\d{1,3})? 100,0{1,3}?

element Terreno_Type/CanoneVincolistico

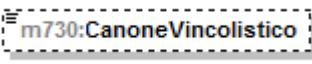
diagram	
namespace	urn:www.agenziaentrate.gov.it:specificheTecniche:sco:730
type	DatoNP_Type
facets	Kind Value pattern [1-9]{1}[0-9]*

element Terreno_Type/CasiParticolari

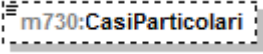
diagram													
namespace	urn:www.agenziaentrate.gov.it:specificheTecniche:sco:730												
type	m730:Casi_Particolari_Terreni_Type												
facets	<table><thead><tr><th>Kind</th><th>Value</th></tr></thead><tbody><tr><td>pattern</td><td>[1-9]</td></tr><tr><td>enumeration</td><td>2</td></tr><tr><td>enumeration</td><td>3</td></tr><tr><td>enumeration</td><td>4</td></tr><tr><td>enumeration</td><td>6</td></tr></tbody></table>	Kind	Value	pattern	[1-9]	enumeration	2	enumeration	3	enumeration	4	enumeration	6
Kind	Value												
pattern	[1-9]												
enumeration	2												
enumeration	3												
enumeration	4												
enumeration	6												

element Terreno_Type/CasellaContinuazione

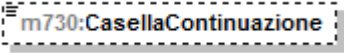
diagram					
namespace	urn:www.agenziaentrate.gov.it:specificheTecniche:sco:730				
type	DatoCB_Type				
facets	<table><thead><tr><th>Kind</th><th>Value</th></tr></thead><tbody><tr><td>pattern</td><td>[01]</td></tr></tbody></table>	Kind	Value	pattern	[01]
Kind	Value				
pattern	[01]				

element Terreno_Type/CasellaImuNonDovuta

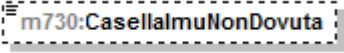
diagram					
namespace	urn:www.agenziaentrate.gov.it:specificheTecniche:sco:730				
type	DatoCB_Type				
facets	<table><thead><tr><th>Kind</th><th>Value</th></tr></thead><tbody><tr><td>pattern</td><td>[01]</td></tr></tbody></table>	Kind	Value	pattern	[01]
Kind	Value				
pattern	[01]				

element Terreno_Type/CasellaColtivatoreDiretto

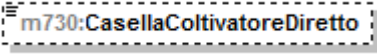
diagram					
namespace	urn:www.agenziaentrate.gov.it:specificheTecniche:sco:730				
type	DatoCB_Type				
facets	<table><thead><tr><th>Kind</th><th>Value</th></tr></thead><tbody><tr><td>pattern</td><td>[01]</td></tr></tbody></table>	Kind	Value	pattern	[01]
Kind	Value				
pattern	[01]				

complexType **Versamenti_F24_Type**

<p>diagram</p>	
<p>namespace</p>	<p>urn:www.agenziaentrate.gov.it:specificheTecniche:sco:730</p>
<p>children</p>	<p>m730:F24DebitoIrpef m730:F24DebitoCodRegione m730:F24DebitoAddReg m730:F24DebitoCodComune m730:F24DebitoAddCom m730:F24DebitoPrimaRataAcclrpef m730:F24DebitoAccontoTassSep m730:F24DebitoCodComuneAcconto m730:F24DebitoAccontoAddCom m730:F24DebitoImpostaSost m730:F24DebitoCedolare m730:F24DebitoPrimaRataAccCedolare m730:F24DebitoContribSolidarieta m730:F24DebitoCodRegioneConiuge m730:F24DebitoAddRegConiuge m730:F24DebitoCodComuneConiuge m730:F24DebitoAddComConiuge m730:F24DebitoCodComuneAccontoConiuge m730:F24DebitoAccontoAddComConiuge m730:F24DebitoSecondaRataAcclrpef m730:F24DebitoSecondaRataAccCedolare</p>

element **Versamenti_F24_Type/F24Debitolrpef**

diagram	 m730:F24Debitolrpef				
namespace	urn:www.agenziaentrate.gov.it:specificheTecniche:sco:730				
type	DatoNP_Type				
facets	<table border="1"> <thead> <tr> <th>Kind</th> <th>Value</th> </tr> </thead> <tbody> <tr> <td>pattern</td> <td>[1-9]{1}[0-9]*</td> </tr> </tbody> </table>	Kind	Value	pattern	[1-9]{1}[0-9]*
Kind	Value				
pattern	[1-9]{1}[0-9]*				

element **Versamenti_F24_Type/F24DebitoCodRegione**

diagram	 m730:F24DebitoCodRegione																																														
namespace	urn:www.agenziaentrate.gov.it:specificheTecniche:sco:730																																														
type	Codice_Regione_Type																																														
facets	<table border="1"> <thead> <tr> <th>Kind</th> <th>Value</th> </tr> </thead> <tbody> <tr> <td>pattern</td> <td>([0-9A-Z\-\]&quot;){1}([0-9A-Z&amp;] \- \., / \^\(\ \)\À È É Ì Ò Ù Ü &quot; \ \ / +)*</td> </tr> <tr><td>enumeration</td><td>1</td></tr> <tr><td>enumeration</td><td>2</td></tr> <tr><td>enumeration</td><td>3</td></tr> <tr><td>enumeration</td><td>4</td></tr> <tr><td>enumeration</td><td>5</td></tr> <tr><td>enumeration</td><td>6</td></tr> <tr><td>enumeration</td><td>7</td></tr> <tr><td>enumeration</td><td>8</td></tr> <tr><td>enumeration</td><td>9</td></tr> <tr><td>enumeration</td><td>10</td></tr> <tr><td>enumeration</td><td>11</td></tr> <tr><td>enumeration</td><td>12</td></tr> <tr><td>enumeration</td><td>13</td></tr> <tr><td>enumeration</td><td>14</td></tr> <tr><td>enumeration</td><td>15</td></tr> <tr><td>enumeration</td><td>16</td></tr> <tr><td>enumeration</td><td>17</td></tr> <tr><td>enumeration</td><td>18</td></tr> <tr><td>enumeration</td><td>19</td></tr> <tr><td>enumeration</td><td>20</td></tr> <tr><td>enumeration</td><td>21</td></tr> </tbody> </table>	Kind	Value	pattern	([0-9A-Z\-\]"){1}([0-9A-Z&] \- \., / \^\(\ \)\À È É Ì Ò Ù Ü " \ \ / +)*	enumeration	1	enumeration	2	enumeration	3	enumeration	4	enumeration	5	enumeration	6	enumeration	7	enumeration	8	enumeration	9	enumeration	10	enumeration	11	enumeration	12	enumeration	13	enumeration	14	enumeration	15	enumeration	16	enumeration	17	enumeration	18	enumeration	19	enumeration	20	enumeration	21
Kind	Value																																														
pattern	([0-9A-Z\-\]"){1}([0-9A-Z&] \- \., / \^\(\ \)\À È É Ì Ò Ù Ü " \ \ / +)*																																														
enumeration	1																																														
enumeration	2																																														
enumeration	3																																														
enumeration	4																																														
enumeration	5																																														
enumeration	6																																														
enumeration	7																																														
enumeration	8																																														
enumeration	9																																														
enumeration	10																																														
enumeration	11																																														
enumeration	12																																														
enumeration	13																																														
enumeration	14																																														
enumeration	15																																														
enumeration	16																																														
enumeration	17																																														
enumeration	18																																														
enumeration	19																																														
enumeration	20																																														
enumeration	21																																														

element **Versamenti_F24_Type/F24DebitoAddReg**

diagram	 m730:F24DebitoAddReg				
namespace	urn:www.agenziaentrate.gov.it:specificheTecniche:sco:730				
type	DatoNP_Type				
facets	<table border="1"> <thead> <tr> <th>Kind</th> <th>Value</th> </tr> </thead> <tbody> <tr> <td>pattern</td> <td>[1-9]{1}[0-9]*</td> </tr> </tbody> </table>	Kind	Value	pattern	[1-9]{1}[0-9]*
Kind	Value				
pattern	[1-9]{1}[0-9]*				

element **Versamenti_F24_Type/F24DebitoCodComune**

diagram	 m730:F24DebitoCodComune
namespace	urn:www.agenziaentrate.gov.it:specificheTecniche:sco:730
type	DatoAN_Type
facets	Kind Value pattern (([0-9A-Z\-\] "){1}([0-9A-Z&:] \- \., / \^\(\)\) À É È Ì Ò Ù Û " \N \\+)*

element **Versamenti_F24_Type/F24DebitoAddCom**

diagram	 m730:F24DebitoAddCom
namespace	urn:www.agenziaentrate.gov.it:specificheTecniche:sco:730
type	DatoNP_Type
facets	Kind Value pattern [1-9]{1}[0-9]*

element **Versamenti_F24_Type/F24DebitoPrimaRataAcclrpef**

diagram	 m730:F24DebitoPrimaRataAcclrpef
namespace	urn:www.agenziaentrate.gov.it:specificheTecniche:sco:730
type	DatoNP_Type
facets	Kind Value pattern [1-9]{1}[0-9]*

element **Versamenti_F24_Type/F24DebitoAccontoTassSep**

diagram	 m730:F24DebitoAccontoTass Sep
namespace	urn:www.agenziaentrate.gov.it:specificheTecniche:sco:730
type	DatoNP_Type
facets	Kind Value pattern [1-9]{1}[0-9]*

element **Versamenti_F24_Type/F24DebitoCodComuneAcconto**

diagram	 m730:F24DebitoCodComuneAcc...
namespace	urn:www.agenziaentrate.gov.it:specificheTecniche:sco:730
type	DatoAN_Type
facets	Kind Value pattern (([0-9A-Z\-\] "){1}([0-9A-Z&:] \- \., / \^\(\)\) À É È Ì Ò Ù Û " \N \\+)*

element **Versamenti_F24_Type/F24DebitoAccontoAddCom**

diagram	 m730:F24DebitoAccontoAddCom
namespace	urn:www.agenziaentrate.gov.it:specificheTecniche:sco:730
type	DatoNP_Type
facets	Kind Value pattern [1-9]{1}[0-9]*

element **Versamenti_F24_Type/F24DebitoImpostaSost**

diagram	 m730:F24DebitoImpostaSost
namespace	urn:www.agenziaentrate.gov.it:specificheTecniche:sco:730
type	DatoNP_Type
facets	Kind Value pattern [1-9]{1}[0-9]*

element **Versamenti_F24_Type/F24DebitoCedolare**

diagram	 m730:F24DebitoCedolare
namespace	urn:www.agenziaentrate.gov.it:specificheTecniche:sco:730
type	DatoNP_Type
facets	Kind Value pattern [1-9]{1}[0-9]*

element **Versamenti_F24_Type/F24DebitoPrimaRataAccCedolare**

diagram	 m730:F24DebitoPrimaRataAccCe...
namespace	urn:www.agenziaentrate.gov.it:specificheTecniche:sco:730
type	DatoNP_Type
facets	Kind Value pattern [1-9]{1}[0-9]*

element **Versamenti_F24_Type/F24DebitoContribSolidarieta**

diagram	 m730:F24DebitoContribSolidarieta
namespace	urn:www.agenziaentrate.gov.it:specificheTecniche:sco:730
type	DatoNP_Type
facets	Kind Value pattern [1-9]{1}[0-9]*

element **Versamenti_F24_Type/F24DebitoCodRegioneConiuge**

diagram	 m730:F24DebitoCodRegioneConi...																																														
namespace	urn:www.agenziaentrate.gov.it:specificheTecniche:sco:730																																														
type	Codice Regione Type																																														
facets	<table border="1"> <thead> <tr> <th>Kind</th> <th>Value</th> </tr> </thead> <tbody> <tr> <td>pattern</td> <td>(([0-9A-Z-] \&quot;){1}([0-9A-Z&amp;] '\ -\ \. , / \° \^ \(\) À È É Ì Ò Ù Û \&quot; \ \\ \ +)*</td> </tr> <tr><td>enumeration</td><td>1</td></tr> <tr><td>enumeration</td><td>2</td></tr> <tr><td>enumeration</td><td>3</td></tr> <tr><td>enumeration</td><td>4</td></tr> <tr><td>enumeration</td><td>5</td></tr> <tr><td>enumeration</td><td>6</td></tr> <tr><td>enumeration</td><td>7</td></tr> <tr><td>enumeration</td><td>8</td></tr> <tr><td>enumeration</td><td>9</td></tr> <tr><td>enumeration</td><td>10</td></tr> <tr><td>enumeration</td><td>11</td></tr> <tr><td>enumeration</td><td>12</td></tr> <tr><td>enumeration</td><td>13</td></tr> <tr><td>enumeration</td><td>14</td></tr> <tr><td>enumeration</td><td>15</td></tr> <tr><td>enumeration</td><td>16</td></tr> <tr><td>enumeration</td><td>17</td></tr> <tr><td>enumeration</td><td>18</td></tr> <tr><td>enumeration</td><td>19</td></tr> <tr><td>enumeration</td><td>20</td></tr> <tr><td>enumeration</td><td>21</td></tr> </tbody> </table>	Kind	Value	pattern	(([0-9A-Z-] \"){1}([0-9A-Z&] '\ -\ \. , / \° \^ \(\) À È É Ì Ò Ù Û \" \ \\ \ +)*	enumeration	1	enumeration	2	enumeration	3	enumeration	4	enumeration	5	enumeration	6	enumeration	7	enumeration	8	enumeration	9	enumeration	10	enumeration	11	enumeration	12	enumeration	13	enumeration	14	enumeration	15	enumeration	16	enumeration	17	enumeration	18	enumeration	19	enumeration	20	enumeration	21
Kind	Value																																														
pattern	(([0-9A-Z-] \"){1}([0-9A-Z&] '\ -\ \. , / \° \^ \(\) À È É Ì Ò Ù Û \" \ \\ \ +)*																																														
enumeration	1																																														
enumeration	2																																														
enumeration	3																																														
enumeration	4																																														
enumeration	5																																														
enumeration	6																																														
enumeration	7																																														
enumeration	8																																														
enumeration	9																																														
enumeration	10																																														
enumeration	11																																														
enumeration	12																																														
enumeration	13																																														
enumeration	14																																														
enumeration	15																																														
enumeration	16																																														
enumeration	17																																														
enumeration	18																																														
enumeration	19																																														
enumeration	20																																														
enumeration	21																																														

element **Versamenti_F24_Type/F24DebitoAddRegConiuge**

diagram	 m730:F24DebitoAddRegConiuge				
namespace	urn:www.agenziaentrate.gov.it:specificheTecniche:sco:730				
type	DatoNP Type				
facets	<table border="1"> <thead> <tr> <th>Kind</th> <th>Value</th> </tr> </thead> <tbody> <tr> <td>pattern</td> <td>[1-9]{1}[0-9]*</td> </tr> </tbody> </table>	Kind	Value	pattern	[1-9]{1}[0-9]*
Kind	Value				
pattern	[1-9]{1}[0-9]*				

element **Versamenti_F24_Type/F24DebitoCodComuneConiuge**

diagram	 m730:F24DebitoCodComuneCon...				
namespace	urn:www.agenziaentrate.gov.it:specificheTecniche:sco:730				
type	DatoAN Type				
facets	<table border="1"> <thead> <tr> <th>Kind</th> <th>Value</th> </tr> </thead> <tbody> <tr> <td>pattern</td> <td>(([0-9A-Z-] \&quot;){1}([0-9A-Z&amp;] '\ -\ \. , / \° \^ \(\) À È É Ì Ò Ù Û \&quot; \ \\ \ +)*</td> </tr> </tbody> </table>	Kind	Value	pattern	(([0-9A-Z-] \"){1}([0-9A-Z&] '\ -\ \. , / \° \^ \(\) À È É Ì Ò Ù Û \" \ \\ \ +)*
Kind	Value				
pattern	(([0-9A-Z-] \"){1}([0-9A-Z&] '\ -\ \. , / \° \^ \(\) À È É Ì Ò Ù Û \" \ \\ \ +)*				

element **Versamenti_F24_Type/F24DebitoAddComConiuge**

diagram	 m730:F24DebitoAddComConiuge
namespace	urn:www.agenziaentrate.gov.it:specificheTecniche:sco:730

type	DatoNP_Type
facets	Kind Value pattern [1-9]{1}[0-9]*

element [Versamenti_F24_Type/F24DebitoCodComuneAccontoConiuge](#)

diagram	
namespace	urn:www.agenziaentrate.gov.it:specificheTecniche:sco:730
type	DatoAN_Type
facets	Kind Value pattern (([0-9A-Z\-\]]"){1}([0-9A-Z&:] \" \- \., / ° \" \(\) À È É Ì Ò Ù Û " \\ / +)*

element [Versamenti_F24_Type/F24DebitoAccontoAddComConiuge](#)

diagram	
namespace	urn:www.agenziaentrate.gov.it:specificheTecniche:sco:730
type	DatoNP_Type
facets	Kind Value pattern [1-9]{1}[0-9]*

element [Versamenti_F24_Type/F24DebitoSecondaRataAcclrpef](#)

diagram	
namespace	urn:www.agenziaentrate.gov.it:specificheTecniche:sco:730
type	DatoNP_Type
facets	Kind Value pattern [1-9]{1}[0-9]*

element [Versamenti_F24_Type/F24DebitoSecondaRataAccCedolare](#)

diagram	
namespace	urn:www.agenziaentrate.gov.it:specificheTecniche:sco:730
type	DatoNP_Type
facets	Kind Value pattern [1-9]{1}[0-9]*

element Intestazione

diagram	
namespace	urn:www.agenziaentrate.gov.it:specificheTecniche:sco:730
type	m730:Intestazione_730_Type
children	m730:TipoFornitore m730:SpazioUtente

complexType Intestazione_730_Type

diagram	
namespace	urn:www.agenziaentrate.gov.it:specificheTecniche:sco:730
children	m730:TipoFornitore m730:SpazioUtente

element Intestazione_730_Type/TipoFornitore

diagram																	
namespace	urn:www.agenziaentrate.gov.it:specificheTecniche:sco:730																
type	restriction of DatoAN_Type																
facets	<table border="1"> <thead> <tr> <th>Kind</th> <th>Value</th> </tr> </thead> <tbody> <tr> <td>pattern</td> <td>([0-9A-Z-] &quot;){1}([0-9A-Z&amp;] ' \" . / ° ^\(\\) À É È Ì Ò Ù Û &quot;; \\ / +)*</td> </tr> <tr> <td>enumeration</td> <td>1</td> </tr> <tr> <td>enumeration</td> <td>2</td> </tr> <tr> <td>enumeration</td> <td>3</td> </tr> <tr> <td>enumeration</td> <td>5</td> </tr> <tr> <td>enumeration</td> <td>6</td> </tr> <tr> <td>enumeration</td> <td>10</td> </tr> </tbody> </table>	Kind	Value	pattern	([0-9A-Z-] "){1}([0-9A-Z&] ' \" . / ° ^\(\\) À É È Ì Ò Ù Û "; \\ / +)*	enumeration	1	enumeration	2	enumeration	3	enumeration	5	enumeration	6	enumeration	10
Kind	Value																
pattern	([0-9A-Z-] "){1}([0-9A-Z&] ' \" . / ° ^\(\\) À É È Ì Ò Ù Û "; \\ / +)*																
enumeration	1																
enumeration	2																
enumeration	3																
enumeration	5																
enumeration	6																
enumeration	10																

element Intestazione_730_Type/SpazioUtente

diagram					
namespace	urn:www.agenziaentrate.gov.it:specificheTecniche:sco:730				
type	DatoAN_Type				
facets	<table border="1"> <thead> <tr> <th>Kind</th> <th>Value</th> </tr> </thead> <tbody> <tr> <td>pattern</td> <td>([0-9A-Z-] &quot;){1}([0-9A-Z&amp;] ' \" . / ° ^\(\\) À É È Ì Ò Ù Û &quot;; \\ / +)*</td> </tr> </tbody> </table>	Kind	Value	pattern	([0-9A-Z-] "){1}([0-9A-Z&] ' \" . / ° ^\(\\) À É È Ì Ò Ù Û "; \\ / +)*
Kind	Value				
pattern	([0-9A-Z-] "){1}([0-9A-Z&] ' \" . / ° ^\(\\) À É È Ì Ò Ù Û "; \\ / +)*				

element Fornitura

diagram	
namespace	www.agenziaentrate.gov.it:specificheTecniche:telent:v1

element Messaggio

diagram	
namespace	www.agenziaentrate.gov.it:specificheTecniche:telent:v1
children	tm:Intestazione tm:Contenuto

element Messaggio/Intestazione

diagram	
namespace	www.agenziaentrate.gov.it:specificheTecniche:telent:v1
type	tm:IntestazioneType
children	tm:CodiceFiscaleFornitore tm:SpazioServizioTelematico

element Messaggio/Contenuto

diagram	
namespace	www.agenziaentrate.gov.it:specificheTecniche:telent:v1
type	tm:ContenutoType

children	tm:Fornitura				
attributes	Name CodiceFornitura	Type derived by: xs:string	Use	Default	Fixed

complexType **ContenutoType**

diagram					
namespace	www.agenziaentrate.gov.it:specificheTecniche:telent:v1				
children	tm:Fornitura				
attributes	Name CodiceFornitura	Type derived by: xs:string	Use	Default	Fixed

attribute **ContenutoType/@CodiceFornitura**

type	restriction of xs:string			
facets	Kind pattern	Value [A-Z0-9]{5}		

complexType **IntestazioneType**

diagram					
namespace	www.agenziaentrate.gov.it:specificheTecniche:telent:v1				
children	tm:CodiceFiscaleFornitore tm:Spazio Servizio Telematico				

element **IntestazioneType/CodiceFiscaleFornitore**

diagram					
namespace	www.agenziaentrate.gov.it:specificheTecniche:telent:v1				
type	restriction of xs:string				
facets	Kind pattern	Value [0-9]{11}[A-Z0-9]{16}			

element IntestazioneType/SpazioServizioTelematico

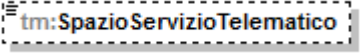
diagram	
namespace	www.agenziaentrate.gov.it:specificheTecniche:telent:v1
type	restriction of xs:string

simpleType Anno_Anticipazione_Fondo_Pensione_Type

namespace	urn:www.agenziaentrate.gov.it:specificheTecniche:sco:730																								
type	restriction of DatoNP_Type																								
facets	<table border="1"> <thead> <tr> <th>Kind</th> <th>Value</th> </tr> </thead> <tbody> <tr> <td>pattern</td> <td>[1-9]{1}[0-9]*</td> </tr> <tr> <td>enumeration</td> <td>2007</td> </tr> <tr> <td>enumeration</td> <td>2008</td> </tr> <tr> <td>enumeration</td> <td>2009</td> </tr> <tr> <td>enumeration</td> <td>2010</td> </tr> <tr> <td>enumeration</td> <td>2011</td> </tr> <tr> <td>enumeration</td> <td>2012</td> </tr> <tr> <td>enumeration</td> <td>2013</td> </tr> <tr> <td>enumeration</td> <td>2014</td> </tr> <tr> <td>enumeration</td> <td>2015</td> </tr> <tr> <td>enumeration</td> <td>2016</td> </tr> </tbody> </table>	Kind	Value	pattern	[1-9]{1}[0-9]*	enumeration	2007	enumeration	2008	enumeration	2009	enumeration	2010	enumeration	2011	enumeration	2012	enumeration	2013	enumeration	2014	enumeration	2015	enumeration	2016
Kind	Value																								
pattern	[1-9]{1}[0-9]*																								
enumeration	2007																								
enumeration	2008																								
enumeration	2009																								
enumeration	2010																								
enumeration	2011																								
enumeration	2012																								
enumeration	2013																								
enumeration	2014																								
enumeration	2015																								
enumeration	2016																								

simpleType Anno_Recupero_Patrimonio_Edilizio_Type

namespace	urn:www.agenziaentrate.gov.it:specificheTecniche:sco:730																								
type	restriction of DatoNP_Type																								
facets	<table border="1"> <thead> <tr> <th>Kind</th> <th>Value</th> </tr> </thead> <tbody> <tr> <td>pattern</td> <td>[1-9]{1}[0-9]*</td> </tr> <tr> <td>enumeration</td> <td>2007</td> </tr> <tr> <td>enumeration</td> <td>2008</td> </tr> <tr> <td>enumeration</td> <td>2009</td> </tr> <tr> <td>enumeration</td> <td>2010</td> </tr> <tr> <td>enumeration</td> <td>2011</td> </tr> <tr> <td>enumeration</td> <td>2012</td> </tr> <tr> <td>enumeration</td> <td>2013</td> </tr> <tr> <td>enumeration</td> <td>2014</td> </tr> <tr> <td>enumeration</td> <td>2015</td> </tr> <tr> <td>enumeration</td> <td>2016</td> </tr> </tbody> </table>	Kind	Value	pattern	[1-9]{1}[0-9]*	enumeration	2007	enumeration	2008	enumeration	2009	enumeration	2010	enumeration	2011	enumeration	2012	enumeration	2013	enumeration	2014	enumeration	2015	enumeration	2016
Kind	Value																								
pattern	[1-9]{1}[0-9]*																								
enumeration	2007																								
enumeration	2008																								
enumeration	2009																								
enumeration	2010																								
enumeration	2011																								
enumeration	2012																								
enumeration	2013																								
enumeration	2014																								
enumeration	2015																								
enumeration	2016																								

simpleType Anno_Risparmio_Energetico_Type

namespace	urn:www.agenziaentrate.gov.it:specificheTecniche:sco:730																		
type	restriction of DatoNP_Type																		
facets	<table border="1"> <thead> <tr> <th>Kind</th> <th>Value</th> </tr> </thead> <tbody> <tr> <td>pattern</td> <td>[1-9]{1}[0-9]*</td> </tr> <tr> <td>enumeration</td> <td>2008</td> </tr> <tr> <td>enumeration</td> <td>2011</td> </tr> <tr> <td>enumeration</td> <td>2012</td> </tr> <tr> <td>enumeration</td> <td>2013</td> </tr> <tr> <td>enumeration</td> <td>2014</td> </tr> <tr> <td>enumeration</td> <td>2015</td> </tr> <tr> <td>enumeration</td> <td>2016</td> </tr> </tbody> </table>	Kind	Value	pattern	[1-9]{1}[0-9]*	enumeration	2008	enumeration	2011	enumeration	2012	enumeration	2013	enumeration	2014	enumeration	2015	enumeration	2016
Kind	Value																		
pattern	[1-9]{1}[0-9]*																		
enumeration	2008																		
enumeration	2011																		
enumeration	2012																		
enumeration	2013																		
enumeration	2014																		
enumeration	2015																		
enumeration	2016																		

simpleType **Casi_Particolari_Fabbricato_Type**

namespace	urn:www.agenziaentrate.gov.it:specificheTecniche:sco:730												
type	restriction of DatoN1_Type												
facets	<table><thead><tr><th>Kind</th><th>Value</th></tr></thead><tbody><tr><td>pattern</td><td>[1-9]</td></tr><tr><td>enumeration</td><td>1</td></tr><tr><td>enumeration</td><td>3</td></tr><tr><td>enumeration</td><td>4</td></tr><tr><td>enumeration</td><td>5</td></tr></tbody></table>	Kind	Value	pattern	[1-9]	enumeration	1	enumeration	3	enumeration	4	enumeration	5
Kind	Value												
pattern	[1-9]												
enumeration	1												
enumeration	3												
enumeration	4												
enumeration	5												

simpleType **Casi_Particolari_Risp_Ener_Type**

namespace	urn:www.agenziaentrate.gov.it:specificheTecniche:sco:730										
type	restriction of DatoN1_Type										
facets	<table><thead><tr><th>Kind</th><th>Value</th></tr></thead><tbody><tr><td>pattern</td><td>[1-9]</td></tr><tr><td>enumeration</td><td>1</td></tr><tr><td>enumeration</td><td>2</td></tr><tr><td>enumeration</td><td>3</td></tr></tbody></table>	Kind	Value	pattern	[1-9]	enumeration	1	enumeration	2	enumeration	3
Kind	Value										
pattern	[1-9]										
enumeration	1										
enumeration	2										
enumeration	3										

simpleType **Casi_Particolari_Terreni_Type**

namespace	urn:www.agenziaentrate.gov.it:specificheTecniche:sco:730												
type	restriction of DatoN1_Type												
facets	<table><thead><tr><th>Kind</th><th>Value</th></tr></thead><tbody><tr><td>pattern</td><td>[1-9]</td></tr><tr><td>enumeration</td><td>2</td></tr><tr><td>enumeration</td><td>3</td></tr><tr><td>enumeration</td><td>4</td></tr><tr><td>enumeration</td><td>6</td></tr></tbody></table>	Kind	Value	pattern	[1-9]	enumeration	2	enumeration	3	enumeration	4	enumeration	6
Kind	Value												
pattern	[1-9]												
enumeration	2												
enumeration	3												
enumeration	4												
enumeration	6												

simpleType **Codice_Altre_Detrazioni_Type**

namespace	urn:www.agenziaentrate.gov.it:specificheTecniche:sco:730								
type	restriction of DatoNP_Type								
facets	<table><thead><tr><th>Kind</th><th>Value</th></tr></thead><tbody><tr><td>pattern</td><td>[1-9]{1}[0-9]*</td></tr><tr><td>enumeration</td><td>1</td></tr><tr><td>enumeration</td><td>2</td></tr></tbody></table>	Kind	Value	pattern	[1-9]{1}[0-9]*	enumeration	1	enumeration	2
Kind	Value								
pattern	[1-9]{1}[0-9]*								
enumeration	1								
enumeration	2								

simpleType **Codice_Altre_Spese_Type**

namespace	urn:www.agenziaentrate.gov.it:specificheTecniche:sco:730																						
type	restriction of DatoNP_Type																						
facets	<table><thead><tr><th>Kind</th><th>Value</th></tr></thead><tbody><tr><td>pattern</td><td>[1-9]{1}[0-9]*</td></tr><tr><td>enumeration</td><td>8</td></tr><tr><td>enumeration</td><td>9</td></tr><tr><td>enumeration</td><td>10</td></tr><tr><td>enumeration</td><td>11</td></tr><tr><td>enumeration</td><td>12</td></tr><tr><td>enumeration</td><td>13</td></tr><tr><td>enumeration</td><td>14</td></tr><tr><td>enumeration</td><td>15</td></tr><tr><td>enumeration</td><td>16</td></tr></tbody></table>	Kind	Value	pattern	[1-9]{1}[0-9]*	enumeration	8	enumeration	9	enumeration	10	enumeration	11	enumeration	12	enumeration	13	enumeration	14	enumeration	15	enumeration	16
Kind	Value																						
pattern	[1-9]{1}[0-9]*																						
enumeration	8																						
enumeration	9																						
enumeration	10																						
enumeration	11																						
enumeration	12																						
enumeration	13																						
enumeration	14																						
enumeration	15																						
enumeration	16																						

enumeration	17
enumeration	18
enumeration	20
enumeration	21
enumeration	22
enumeration	23
enumeration	24
enumeration	25
enumeration	26
enumeration	27
enumeration	28
enumeration	29
enumeration	30
enumeration	31
enumeration	32
enumeration	33
enumeration	35
enumeration	36
enumeration	38
enumeration	39
enumeration	41
enumeration	42
enumeration	99

simpleType **Codice_Altri_Oneri_Type**

namespace	urn:www.agenziaentrate.gov.it:specificheTecniche:sco:730																		
type	restriction of DatoNP_Type																		
facets	<table border="1"> <thead> <tr><th>Kind</th><th>Value</th></tr> </thead> <tbody> <tr><td>pattern</td><td>[1-9]{1}[0-9]*</td></tr> <tr><td>enumeration</td><td>6</td></tr> <tr><td>enumeration</td><td>7</td></tr> <tr><td>enumeration</td><td>8</td></tr> <tr><td>enumeration</td><td>9</td></tr> <tr><td>enumeration</td><td>12</td></tr> <tr><td>enumeration</td><td>13</td></tr> <tr><td>enumeration</td><td>21</td></tr> </tbody> </table>	Kind	Value	pattern	[1-9]{1}[0-9]*	enumeration	6	enumeration	7	enumeration	8	enumeration	9	enumeration	12	enumeration	13	enumeration	21
Kind	Value																		
pattern	[1-9]{1}[0-9]*																		
enumeration	6																		
enumeration	7																		
enumeration	8																		
enumeration	9																		
enumeration	12																		
enumeration	13																		
enumeration	21																		

simpleType **Codice_Canone_Type**

namespace	urn:www.agenziaentrate.gov.it:specificheTecniche:sco:730												
type	restriction of DatoN1_Type												
facets	<table border="1"> <thead> <tr><th>Kind</th><th>Value</th></tr> </thead> <tbody> <tr><td>pattern</td><td>[1-9]</td></tr> <tr><td>enumeration</td><td>1</td></tr> <tr><td>enumeration</td><td>2</td></tr> <tr><td>enumeration</td><td>3</td></tr> <tr><td>enumeration</td><td>4</td></tr> </tbody> </table>	Kind	Value	pattern	[1-9]	enumeration	1	enumeration	2	enumeration	3	enumeration	4
Kind	Value												
pattern	[1-9]												
enumeration	1												
enumeration	2												
enumeration	3												
enumeration	4												

simpleType **Codice_Evento_Eccezionale_Type**

namespace	urn:www.agenziaentrate.gov.it:specificheTecniche:sco:730																
type	restriction of DatoNP_Type																
facets	<table border="1"> <thead> <tr><th>Kind</th><th>Value</th></tr> </thead> <tbody> <tr><td>pattern</td><td>[1-9]{1}[0-9]*</td></tr> <tr><td>enumeration</td><td>1</td></tr> <tr><td>enumeration</td><td>2</td></tr> <tr><td>enumeration</td><td>3</td></tr> <tr><td>enumeration</td><td>4</td></tr> <tr><td>enumeration</td><td>5</td></tr> <tr><td>enumeration</td><td>6</td></tr> </tbody> </table>	Kind	Value	pattern	[1-9]{1}[0-9]*	enumeration	1	enumeration	2	enumeration	3	enumeration	4	enumeration	5	enumeration	6
Kind	Value																
pattern	[1-9]{1}[0-9]*																
enumeration	1																
enumeration	2																
enumeration	3																
enumeration	4																
enumeration	5																
enumeration	6																

simpleType Codice_Spese_Rateizzate_Anni_Precedenti_Type

namespace	urn:www.agenziaentrate.gov.it:specificheTecniche:sco:730										
type	restriction of DatoNP_Type										
facets	<table><thead><tr><th>Kind</th><th>Value</th></tr></thead><tbody><tr><td>pattern</td><td>[1-9]{1}[0-9]*</td></tr><tr><td>enumeration</td><td>2</td></tr><tr><td>enumeration</td><td>3</td></tr><tr><td>enumeration</td><td>4</td></tr></tbody></table>	Kind	Value	pattern	[1-9]{1}[0-9]*	enumeration	2	enumeration	3	enumeration	4
Kind	Value										
pattern	[1-9]{1}[0-9]*										
enumeration	2										
enumeration	3										
enumeration	4										

simpleType Codice_Spese_Rateizzate_Type

namespace	urn:www.agenziaentrate.gov.it:specificheTecniche:sco:730												
type	restriction of DatoNP_Type												
facets	<table><thead><tr><th>Kind</th><th>Value</th></tr></thead><tbody><tr><td>pattern</td><td>[1-9]{1}[0-9]*</td></tr><tr><td>enumeration</td><td>1</td></tr><tr><td>enumeration</td><td>2</td></tr><tr><td>enumeration</td><td>3</td></tr><tr><td>enumeration</td><td>4</td></tr></tbody></table>	Kind	Value	pattern	[1-9]{1}[0-9]*	enumeration	1	enumeration	2	enumeration	3	enumeration	4
Kind	Value												
pattern	[1-9]{1}[0-9]*												
enumeration	1												
enumeration	2												
enumeration	3												
enumeration	4												

simpleType Fabbricato_Agev_Numero_Rigo_Type

namespace	urn:www.agenziaentrate.gov.it:specificheTecniche:sco:730																								
type	restriction of DatoNP_Type																								
facets	<table><thead><tr><th>Kind</th><th>Value</th></tr></thead><tbody><tr><td>pattern</td><td>[1-9]{1}[0-9]*</td></tr><tr><td>enumeration</td><td>1</td></tr><tr><td>enumeration</td><td>2</td></tr><tr><td>enumeration</td><td>3</td></tr><tr><td>enumeration</td><td>4</td></tr><tr><td>enumeration</td><td>5</td></tr><tr><td>enumeration</td><td>6</td></tr><tr><td>enumeration</td><td>7</td></tr><tr><td>enumeration</td><td>8</td></tr><tr><td>enumeration</td><td>9</td></tr><tr><td>enumeration</td><td>10</td></tr></tbody></table>	Kind	Value	pattern	[1-9]{1}[0-9]*	enumeration	1	enumeration	2	enumeration	3	enumeration	4	enumeration	5	enumeration	6	enumeration	7	enumeration	8	enumeration	9	enumeration	10
Kind	Value																								
pattern	[1-9]{1}[0-9]*																								
enumeration	1																								
enumeration	2																								
enumeration	3																								
enumeration	4																								
enumeration	5																								
enumeration	6																								
enumeration	7																								
enumeration	8																								
enumeration	9																								
enumeration	10																								

simpleType Indeterminato_Determinato_Type

namespace	urn:www.agenziaentrate.gov.it:specificheTecniche:sco:730								
type	restriction of DatoN1_Type								
facets	<table><thead><tr><th>Kind</th><th>Value</th></tr></thead><tbody><tr><td>pattern</td><td>[1-9]</td></tr><tr><td>enumeration</td><td>1</td></tr><tr><td>enumeration</td><td>2</td></tr></tbody></table>	Kind	Value	pattern	[1-9]	enumeration	1	enumeration	2
Kind	Value								
pattern	[1-9]								
enumeration	1								
enumeration	2								

simpleType Integrativo_Type

namespace	urn:www.agenziaentrate.gov.it:specificheTecniche:sco:730				
type	restriction of DatoN1_Type				
facets	<table><thead><tr><th>Kind</th><th>Value</th></tr></thead><tbody><tr><td>pattern</td><td>[1-9]</td></tr></tbody></table>	Kind	Value	pattern	[1-9]
Kind	Value				
pattern	[1-9]				

	enumeration	1
	enumeration	2
	enumeration	3

simpleType **Mesi_Type**

namespace	urn:www.agenziaentrate.gov.it:specificheTecniche:sco:730	
type	restriction of DatoNP_Type	
facets	Kind	Value
	pattern	[1-9]{1}[0-9]*
	enumeration	1
	enumeration	2
	enumeration	3
	enumeration	4
	enumeration	5
	enumeration	6
	enumeration	7
	enumeration	8
	enumeration	9
	enumeration	10
	enumeration	11
	enumeration	12

simpleType **Numero_Rata_Risparmio_Energetico_Type**

namespace	urn:www.agenziaentrate.gov.it:specificheTecniche:sco:730	
type	restriction of DatoNP_Type	
facets	Kind	Value
	pattern	[1-9]{1}[0-9]*
	enumeration	1
	enumeration	2
	enumeration	3
	enumeration	4
	enumeration	5
	enumeration	6
	enumeration	9

simpleType **Periodo_Spese_Ristrutturazione_Type**

namespace	urn:www.agenziaentrate.gov.it:specificheTecniche:sco:730	
type	restriction of DatoN1_Type	
facets	Kind	Value
	pattern	[1-9]
	enumeration	2
	enumeration	3
	enumeration	4

simpleType **Rate10_Type**

namespace	urn:www.agenziaentrate.gov.it:specificheTecniche:sco:730	
type	restriction of DatoNP_Type	
facets	Kind	Value
	pattern	[1-9]{1}[0-9]*
	enumeration	1
	enumeration	2
	enumeration	3
	enumeration	4

	enumeration	5
	enumeration	6
	enumeration	7
	enumeration	8
	enumeration	9
	enumeration	10

simpleType **Rate_Risparmio_Energetico_Type**

namespace	urn:www.agenziaentrate.gov.it:specificheTecniche:sco:730	
type	restriction of DatoNP_Type	
facets	Kind	Value
	pattern	[1-9]{1}[0-9]*
	enumeration	4
	enumeration	5
	enumeration	6
	enumeration	7
	enumeration	8
	enumeration	9
	enumeration	10

simpleType **Reintegro_Totale_Parziale_Type**

namespace	urn:www.agenziaentrate.gov.it:specificheTecniche:sco:730	
type	restriction of DatoN1_Type	
facets	Kind	Value
	pattern	[1-9]
	enumeration	1
	enumeration	2

simpleType **Rettificativo_Type**

namespace	urn:www.agenziaentrate.gov.it:specificheTecniche:sco:730	
type	restriction of DatoN1_Type	
facets	Kind	Value
	pattern	[1-9]
	enumeration	1
	enumeration	2
	enumeration	3

simpleType **Ripart_Risparmio_Energetico_Type**

namespace	urn:www.agenziaentrate.gov.it:specificheTecniche:sco:730	
type	restriction of DatoNP_Type	
facets	Kind	Value
	pattern	[1-9]{1}[0-9]*
	enumeration	9
	enumeration	10

simpleType **Serie_Registrazione_Contratto_Type**

namespace	urn:www.agenziaentrate.gov.it:specificheTecniche:sco:730	
type	restriction of DatoAN_Type	
facets	Kind	Value

	pattern	(([0-9A-Z-] "){1}([0-9A-Z&] ' - \., / ° °\ (\)A É É Ï Ï Ü Ü "; \\ / +)*
	enumeration	3
	enumeration	3A
	enumeration	3B
	enumeration	3P
	enumeration	3T

simpleType **Stato_Civile_Type**

namespace	urn:www.agenziaentrate.gov.it:specificheTecniche:sco:730	
type	restriction of DatoNP_Type	
facets	Kind	Value
	pattern	[1-9]{1}[0-9]*
	enumeration	7
	enumeration	8

simpleType **Terreni_Urbano_Type**

namespace	urn:www.agenziaentrate.gov.it:specificheTecniche:sco:730	
type	restriction of DatoAN_Type	
facets	Kind	Value
	pattern	(([0-9A-Z-] "){1}([0-9A-Z&] ' - \., / ° °\ (\)A É É Ï Ï Ü Ü "; \\ / +)*
	enumeration	T
	enumeration	U

simpleType **Tipo_Inquilino_Type**

namespace	urn:www.agenziaentrate.gov.it:specificheTecniche:sco:730	
type	restriction of DatoNP_Type	
facets	Kind	Value
	pattern	[1-9]{1}[0-9]*
	enumeration	1
	enumeration	2
	enumeration	3
	enumeration	4

simpleType **Tipo_Intervento_Type**

namespace	urn:www.agenziaentrate.gov.it:specificheTecniche:sco:730	
type	restriction of DatoN1_Type	
facets	Kind	Value
	pattern	[1-9]
	enumeration	1
	enumeration	2
	enumeration	3
	enumeration	4
	enumeration	5
	enumeration	6
	enumeration	7

simpleType **Tipo_Reddito_Da1a12_Type**

namespace	urn:www.agenziaentrate.gov.it:specificheTecniche:sco:730	
type	restriction of DatoNP_Type	

facets	Kind	Value
	pattern	[1-9]{1}[0-9]*
	enumeration	1
	enumeration	2
	enumeration	3
	enumeration	4
	enumeration	5
	enumeration	6
	enumeration	7
	enumeration	8
	enumeration	9
	enumeration	10
	enumeration	11
enumeration	12	

simpleType **Tipo_Redito_Da1a3_Type**

namespace	urn:www.agenziaentrate.gov.it:specificheTecniche:sco:730	
type	restriction of DatoN1_Type	
facets	Kind	Value
	pattern	[1-9]
	enumeration	1
	enumeration	2
	enumeration	3
	enumeration	3

simpleType **Tipo_Redito_Da1a4_Type**

namespace	urn:www.agenziaentrate.gov.it:specificheTecniche:sco:730	
type	restriction of DatoN1_Type	
facets	Kind	Value
	pattern	[1-9]
	enumeration	1
	enumeration	2
	enumeration	3
	enumeration	4

simpleType **Tipo_Redito_Da1a8_Type**

namespace	urn:www.agenziaentrate.gov.it:specificheTecniche:sco:730	
type	restriction of DatoNP_Type	
facets	Kind	Value
	pattern	[1-9]{1}[0-9]*
	enumeration	1
	enumeration	2
	enumeration	3
	enumeration	4
	enumeration	5
	enumeration	6
	enumeration	7
	enumeration	8

simpleType **Tipo_Redito_Da1a9_Type**

namespace	urn:www.agenziaentrate.gov.it:specificheTecniche:sco:730	
type	restriction of DatoNP_Type	
facets	Kind	Value
	pattern	[1-9]{1}[0-9]*

	enumeration	1
	enumeration	2
	enumeration	3
	enumeration	4
	enumeration	5
	enumeration	6
	enumeration	7
	enumeration	8
	enumeration	9

simpleType **Tipologia_Soggetto_Ass_Fisc_Type**

namespace	urn:www.agenziaentrate.gov.it:specificheTecniche:sco:730	
type	restriction of DatoN1_Type	
facets	Kind	Value
	pattern	[1-9]
	enumeration	1
	enumeration	2
	enumeration	3
	enumeration	4
	enumeration	5

simpleType **Titolo_Terreno_Type**

namespace	urn:www.agenziaentrate.gov.it:specificheTecniche:sco:730	
type	restriction of DatoNP_Type	
facets	Kind	Value
	pattern	[1-9]{1}[0-9]*
	enumeration	1
	enumeration	2
	enumeration	3
	enumeration	4
	enumeration	5
	enumeration	6
	enumeration	7
	enumeration	10

simpleType **Utilizzo_Fabbricato_Type**

namespace	urn:www.agenziaentrate.gov.it:specificheTecniche:sco:730	
type	restriction of DatoNP_Type	
facets	Kind	Value
	pattern	[1-9]{1}[0-9]*
	enumeration	1
	enumeration	2
	enumeration	3
	enumeration	4
	enumeration	5
	enumeration	8
	enumeration	9
	enumeration	10
	enumeration	11
	enumeration	12
	enumeration	14
	enumeration	15
	enumeration	16
	enumeration	17

element Documento

diagram					
namespace	urn:www.agenziaentrate.gov.it:specificheTecniche:common				
type	Documento Type				
attributes	Name	Type	Use	Default	Fixed
	identificativo	Identificativo Type	required		

complexType Documento_Type

diagram					
namespace	urn:www.agenziaentrate.gov.it:specificheTecniche:common				
attributes	Name	Type	Use	Default	Fixed
	identificativo	Identificativo Type	required		

attribute Documento_Type/@identificativo

type	Identificativo Type				
facets	Kind	Value			
	pattern	[0-9]{4}[1-9] [0-9]{3}[1-9][0-9] [0-9]{2}[1-9][0-9]{2} [0-9][1-9][0-9]{3} [1-9][0-9]{4}			

simpleType Identificativo_Type

namespace	urn:www.agenziaentrate.gov.it:specificheTecniche:common				
type	restriction of xs:string				
facets	Kind	Value			
	pattern	[0-9]{4}[1-9] [0-9]{3}[1-9][0-9] [0-9]{2}[1-9][0-9]{2} [0-9][1-9][0-9]{3} [1-9][0-9]{4}			

complexType Dati_Anagrafici_Type

diagram	
namespace	urn:www.agenziaentrate.gov.it:specificheTecniche:sco:common
children	Cognome Nome Sesso DataNascita ComuneNascita ProvinciaNascita

element Dati_Anagrafici_Type/Cognome

diagram					
namespace	urn:www.agenziaentrate.gov.it:specificheTecniche:sco:common				
type	DatoAN_Type				
facets	<table border="0"> <tr> <td>Kind</td> <td>Value</td> </tr> <tr> <td>pattern</td> <td>(([0-9A-Z\-\]&quot;){1}([0-9A-Z&amp;] \- \., / \° \^ \(\) À É È Ì Ò Ù Ü &quot; \ \\ \ +)*</td> </tr> </table>	Kind	Value	pattern	(([0-9A-Z\-\]"){1}([0-9A-Z&] \- \., / \° \^ \(\) À É È Ì Ò Ù Ü " \ \\ \ +)*
Kind	Value				
pattern	(([0-9A-Z\-\]"){1}([0-9A-Z&] \- \., / \° \^ \(\) À É È Ì Ò Ù Ü " \ \\ \ +)*				

element Dati_Anagrafici_Type/Nome

diagram					
namespace	urn:www.agenziaentrate.gov.it:specificheTecniche:sco:common				
type	DatoAN_Type				
facets	<table border="0"> <tr> <td>Kind</td> <td>Value</td> </tr> <tr> <td>pattern</td> <td>(([0-9A-Z\-\]&quot;){1}([0-9A-Z&amp;] \- \., / \° \^ \(\) À É È Ì Ò Ù Ü &quot; \ \\ \ +)*</td> </tr> </table>	Kind	Value	pattern	(([0-9A-Z\-\]"){1}([0-9A-Z&] \- \., / \° \^ \(\) À É È Ì Ò Ù Ü " \ \\ \ +)*
Kind	Value				
pattern	(([0-9A-Z\-\]"){1}([0-9A-Z&] \- \., / \° \^ \(\) À É È Ì Ò Ù Ü " \ \\ \ +)*				

element Dati_Anagrafici_Type/Sesso

diagram									
namespace	urn:www.agenziaentrate.gov.it:specificheTecniche:sco:common								
type	Sesso_Type								
facets	<table border="0"> <tr> <td>Kind</td> <td>Value</td> </tr> <tr> <td>pattern</td> <td>(([0-9A-Z\-\]&quot;){1}([0-9A-Z&amp;] \- \., / \° \^ \(\) À É È Ì Ò Ù Ü &quot; \ \\ \ +)*</td> </tr> <tr> <td>enumeration</td> <td>M</td> </tr> <tr> <td>enumeration</td> <td>F</td> </tr> </table>	Kind	Value	pattern	(([0-9A-Z\-\]"){1}([0-9A-Z&] \- \., / \° \^ \(\) À É È Ì Ò Ù Ü " \ \\ \ +)*	enumeration	M	enumeration	F
Kind	Value								
pattern	(([0-9A-Z\-\]"){1}([0-9A-Z&] \- \., / \° \^ \(\) À É È Ì Ò Ù Ü " \ \\ \ +)*								
enumeration	M								
enumeration	F								

complexType **Dati_Sottoscrittore_Type**

diagram	
namespace	urn:www.agenziaentrate.gov.it:specificheTecniche:sco:common
children	CodiceFiscale CodiceCarica CodiceFiscaleSocieta DatiAnagrafici ResidenzaEstera Telefono DataCarica InizioProcedura ProceduraNonTerminata FineProcedura

element **Dati_Sottoscrittore_Type/CodiceFiscale**

diagram					
namespace	urn:www.agenziaentrate.gov.it:specificheTecniche:sco:common				
type	DatoCF_Type				
facets	<table border="1"> <thead> <tr> <th>Kind</th> <th>Value</th> </tr> </thead> <tbody> <tr> <td>pattern</td> <td>[0-9]{11}[A-Z]{6}[0-9LMNPQRSTUUV]{2}[A-Z]{1}[0-9LMNPQRSTUUV]{2}[A-Z]{1}[0-9LMNPQRSTUUV]{3}[A-Z]{1}</td> </tr> </tbody> </table>	Kind	Value	pattern	[0-9]{11}[A-Z]{6}[0-9LMNPQRSTUUV]{2}[A-Z]{1}[0-9LMNPQRSTUUV]{2}[A-Z]{1}[0-9LMNPQRSTUUV]{3}[A-Z]{1}
Kind	Value				
pattern	[0-9]{11}[A-Z]{6}[0-9LMNPQRSTUUV]{2}[A-Z]{1}[0-9LMNPQRSTUUV]{2}[A-Z]{1}[0-9LMNPQRSTUUV]{3}[A-Z]{1}				

element **Dati_Sottoscrittore_Type/CodiceCarica**

diagram																					
namespace	urn:www.agenziaentrate.gov.it:specificheTecniche:sco:common																				
type	Codice_Carica_Type																				
facets	<table border="1"> <thead> <tr> <th>Kind</th> <th>Value</th> </tr> </thead> <tbody> <tr> <td>pattern</td> <td>[1-9]{1}[0-9]*</td> </tr> <tr> <td>enumeration</td> <td>1</td> </tr> <tr> <td>enumeration</td> <td>2</td> </tr> <tr> <td>enumeration</td> <td>3</td> </tr> <tr> <td>enumeration</td> <td>4</td> </tr> <tr> <td>enumeration</td> <td>5</td> </tr> <tr> <td>enumeration</td> <td>6</td> </tr> <tr> <td>enumeration</td> <td>7</td> </tr> <tr> <td>enumeration</td> <td>8</td> </tr> </tbody> </table>	Kind	Value	pattern	[1-9]{1}[0-9]*	enumeration	1	enumeration	2	enumeration	3	enumeration	4	enumeration	5	enumeration	6	enumeration	7	enumeration	8
Kind	Value																				
pattern	[1-9]{1}[0-9]*																				
enumeration	1																				
enumeration	2																				
enumeration	3																				
enumeration	4																				
enumeration	5																				
enumeration	6																				
enumeration	7																				
enumeration	8																				

	enumeration	9
	enumeration	10
	enumeration	11
	enumeration	12
	enumeration	13
	enumeration	14
	enumeration	15

element Dati_Sottoscrittore_Type/CodiceFiscaleSocieta

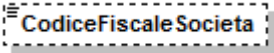
diagram	
namespace	urn:www.agenziaentrate.gov.it:specificheTecniche:sco:common
type	DatoCN Type
facets	Kind Value pattern [0-9]{11}

element Dati_Sottoscrittore_Type/DatiAnagrafici

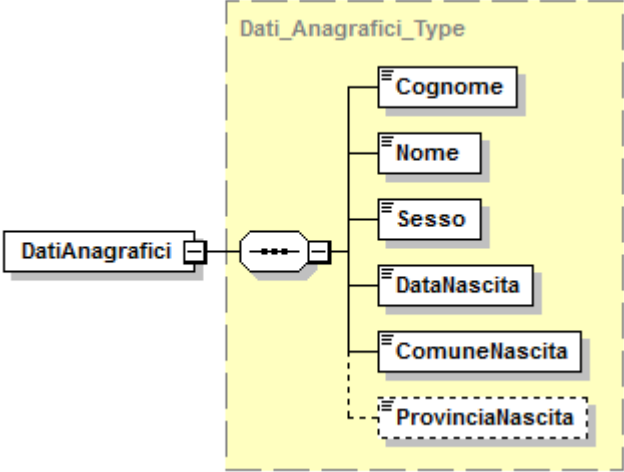
diagram	
namespace	urn:www.agenziaentrate.gov.it:specificheTecniche:sco:common
type	Dati_Anagrafici Type
children	Cognome Nome Sesso DataNascita ComuneNascita ProvinciaNascita

element **Dati_Sottoscrittore_Type/ResidenzaEstera**

diagram	
namespace	urn:www.agenziaentrate.gov.it:specificheTecniche:sco:common
type	Residenza_Estera_Type
children	CodiceStatoEstero StatoFederato LocalitaEstero IndirizzoEstero

element **Dati_Sottoscrittore_Type/Telefono**

diagram					
namespace	urn:www.agenziaentrate.gov.it:specificheTecniche:sco:common				
type	DatoTL_Type				
facets	<table border="1"> <thead> <tr> <th>Kind</th> <th>Value</th> </tr> </thead> <tbody> <tr> <td>pattern</td> <td>[0-9]*</td> </tr> </tbody> </table>	Kind	Value	pattern	[0-9]*
Kind	Value				
pattern	[0-9]*				

element **Dati_Sottoscrittore_Type/DataCarica**

diagram					
namespace	urn:www.agenziaentrate.gov.it:specificheTecniche:sco:common				
type	DatoDT_Type				
facets	<table border="1"> <thead> <tr> <th>Kind</th> <th>Value</th> </tr> </thead> <tbody> <tr> <td>pattern</td> <td>((([0-9]{1,12}[0-9]{3,01})(0[13578][10]12\d{4})) ([0-9]{1,12}[0-9]{30}(0[469][11]\d{4})) ([0-9]{1,12}[0-9]{2[0-8]}(02\d{4})) ((29)(02)[02468][048]00)) ((29)(02)[13579][26]00)) ((29)(02)[0-9][0-9][0148])) ((29)(02)[0-9][0-9][2468][048])) ((29)(02)[0-9][0-9][13579][26]))</td> </tr> </tbody> </table>	Kind	Value	pattern	((([0-9]{1,12}[0-9]{3,01})(0[13578][10]12\d{4})) ([0-9]{1,12}[0-9]{30}(0[469][11]\d{4})) ([0-9]{1,12}[0-9]{2[0-8]}(02\d{4})) ((29)(02)[02468][048]00)) ((29)(02)[13579][26]00)) ((29)(02)[0-9][0-9][0148])) ((29)(02)[0-9][0-9][2468][048])) ((29)(02)[0-9][0-9][13579][26]))
Kind	Value				
pattern	((([0-9]{1,12}[0-9]{3,01})(0[13578][10]12\d{4})) ([0-9]{1,12}[0-9]{30}(0[469][11]\d{4})) ([0-9]{1,12}[0-9]{2[0-8]}(02\d{4})) ((29)(02)[02468][048]00)) ((29)(02)[13579][26]00)) ((29)(02)[0-9][0-9][0148])) ((29)(02)[0-9][0-9][2468][048])) ((29)(02)[0-9][0-9][13579][26]))				

element **Dati_Sottoscrittore_Type/InizioProcedura**

diagram					
namespace	urn:www.agenziaentrate.gov.it:specificheTecniche:sco:common				
type	DatoDT_Type				
facets	<table border="1"> <thead> <tr> <th>Kind</th> <th>Value</th> </tr> </thead> <tbody> <tr> <td>pattern</td> <td>((([0-9]{1,12}[0-9]{3,01})(0[13578][10]12\d{4})) ([0-9]{1,12}[0-9]{30}(0[469][11]\d{4})) ([0-9]{1,12}[0-9]{2[0-8]}(02\d{4})) ((29)(02)[02468][048]00)) ((29)(02)[13579][26]00)) ((29)(02)[0-9][0-9][0148])) ((29)(02)[0-9][0-9][2468][048])) ((29)(02)[0-9][0-9][13579][26]))</td> </tr> </tbody> </table>	Kind	Value	pattern	((([0-9]{1,12}[0-9]{3,01})(0[13578][10]12\d{4})) ([0-9]{1,12}[0-9]{30}(0[469][11]\d{4})) ([0-9]{1,12}[0-9]{2[0-8]}(02\d{4})) ((29)(02)[02468][048]00)) ((29)(02)[13579][26]00)) ((29)(02)[0-9][0-9][0148])) ((29)(02)[0-9][0-9][2468][048])) ((29)(02)[0-9][0-9][13579][26]))
Kind	Value				
pattern	((([0-9]{1,12}[0-9]{3,01})(0[13578][10]12\d{4})) ([0-9]{1,12}[0-9]{30}(0[469][11]\d{4})) ([0-9]{1,12}[0-9]{2[0-8]}(02\d{4})) ((29)(02)[02468][048]00)) ((29)(02)[13579][26]00)) ((29)(02)[0-9][0-9][0148])) ((29)(02)[0-9][0-9][2468][048])) ((29)(02)[0-9][0-9][13579][26]))				

element **Dati_Sottoscrittore_Type/ProceduraNonTerminata**

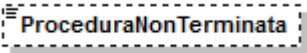
diagram	
namespace	urn:www.agenziaentrate.gov.it:specificheTecniche:sco:common
type	DatoCB_Type
facets	Kind Value pattern [01]

element **Dati_Sottoscrittore_Type/FineProcedura**

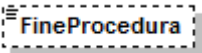
diagram	
namespace	urn:www.agenziaentrate.gov.it:specificheTecniche:sco:common
type	DatoDT_Type
facets	Kind Value pattern (((([0-9]{12} [0-9]{3}[01]) (0[13578] 10 12)\d{4})) ((([0-9]{1-9} [12][0-9] 30)(0[469] 11)\d{4})) ((([0-9]{1}[0-9] 2[0-8])(02)\d{4})) ((29)(02)([02468][048]00)) ((29)(02)([13579][26]00)) ((29)(02)([0-9][0-9][0][48])) ((29)(02)([0-9][0-9][2468][048])) ((29)(02)([0-9][0-9][13579][26]))))

complexType **Domicilio_EE_Type**

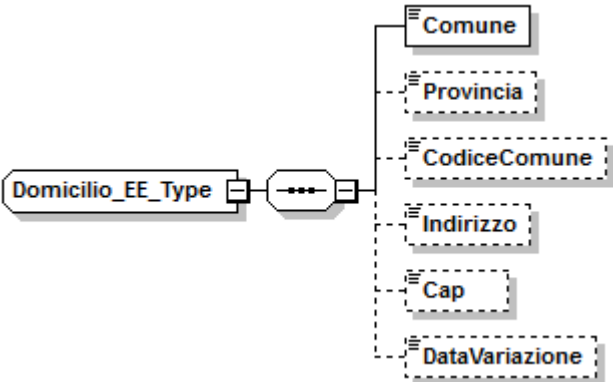
diagram	
namespace	urn:www.agenziaentrate.gov.it:specificheTecniche:sco:common
children	Comune Provincia CodiceComune Indirizzo Cap DataVariazione

element **Domicilio_EE_Type/Comune**

diagram	
namespace	urn:www.agenziaentrate.gov.it:specificheTecniche:sco:common
type	DatoAN_Type
facets	Kind Value pattern ([0-9A-Z-] \"){1}([0-9A-Z&#39; \- \., / ° ^\(\)\ À È É Ì Ò Ù Û \" \ \ / +)*

element Domicilio_EE_Type/Provincia

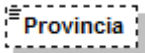
diagram	
namespace	urn:www.agenziaentrate.gov.it:specificheTecniche:sco:common
type	PE_Type

element Domicilio_EE_Type/CodiceComune

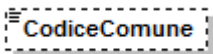
diagram					
namespace	urn:www.agenziaentrate.gov.it:specificheTecniche:sco:common				
type	DatoAN_Type				
facets	<table border="0"> <tr> <td>Kind</td> <td>Value</td> </tr> <tr> <td>pattern</td> <td>(([0-9A-Z\-_]&quot;){1}([0-9A-Z&amp;:] \-\ \. , / \^\(\ \)\À É È Ì Ò Ù Û &quot; \ \ /+)*</td> </tr> </table>	Kind	Value	pattern	(([0-9A-Z\-_]"){1}([0-9A-Z&:] \-\ \. , / \^\(\ \)\À É È Ì Ò Ù Û " \ \ /+)*
Kind	Value				
pattern	(([0-9A-Z\-_]"){1}([0-9A-Z&:] \-\ \. , / \^\(\ \)\À É È Ì Ò Ù Û " \ \ /+)*				

element Domicilio_EE_Type/Indirizzo

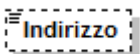
diagram					
namespace	urn:www.agenziaentrate.gov.it:specificheTecniche:sco:common				
type	DatoAN_Type				
facets	<table border="0"> <tr> <td>Kind</td> <td>Value</td> </tr> <tr> <td>pattern</td> <td>(([0-9A-Z\-_]&quot;){1}([0-9A-Z&amp;:] \-\ \. , / \^\(\ \)\À É È Ì Ò Ù Û &quot; \ \ /+)*</td> </tr> </table>	Kind	Value	pattern	(([0-9A-Z\-_]"){1}([0-9A-Z&:] \-\ \. , / \^\(\ \)\À É È Ì Ò Ù Û " \ \ /+)*
Kind	Value				
pattern	(([0-9A-Z\-_]"){1}([0-9A-Z&:] \-\ \. , / \^\(\ \)\À É È Ì Ò Ù Û " \ \ /+)*				

element Domicilio_EE_Type/Cap

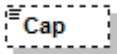
diagram					
namespace	urn:www.agenziaentrate.gov.it:specificheTecniche:sco:common				
type	DatoCP_Type				
facets	<table border="0"> <tr> <td>Kind</td> <td>Value</td> </tr> <tr> <td>pattern</td> <td>[0-9]{5}</td> </tr> </table>	Kind	Value	pattern	[0-9]{5}
Kind	Value				
pattern	[0-9]{5}				

element Domicilio_EE_Type/DataVariazione

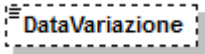
diagram					
namespace	urn:www.agenziaentrate.gov.it:specificheTecniche:sco:common				
type	DatoD6_Type				
facets	<table border="0"> <tr> <td>Kind</td> <td>Value</td> </tr> <tr> <td>pattern</td> <td>((0[0-9])(1[0-2]))((19 20)[0-9][0-9])</td> </tr> </table>	Kind	Value	pattern	((0[0-9])(1[0-2]))((19 20)[0-9][0-9])
Kind	Value				
pattern	((0[0-9])(1[0-2]))((19 20)[0-9][0-9])				

complexType **Domicilio_Fiscale_Type**

diagram	
namespace	urn:www.agenziaentrate.gov.it:specificheTecniche:sco:common
type	extension of Domicilio_Ita_Type
children	Comune Provincia CodiceComune Indirizzo Cap DataVariazione

element **Domicilio_Fiscale_Type/DataVariazione**

diagram					
namespace	urn:www.agenziaentrate.gov.it:specificheTecniche:sco:common				
type	DatoD6_Type				
facets	<table border="0"> <tr> <td>Kind</td> <td>Value</td> </tr> <tr> <td>pattern</td> <td>((0[0-9]) (1[0-2]))((19 20)[0-9][0-9])</td> </tr> </table>	Kind	Value	pattern	((0[0-9]) (1[0-2]))((19 20)[0-9][0-9])
Kind	Value				
pattern	((0[0-9]) (1[0-2]))((19 20)[0-9][0-9])				

complexType **Domicilio_Ita_Type**

diagram	
namespace	urn:www.agenziaentrate.gov.it:specificheTecniche:sco:common
children	Comune Provincia CodiceComune Indirizzo Cap

element **Domicilio_Ita_Type/Comune**

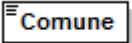
diagram	
namespace	urn:www.agenziaentrategov.it:specificheTecniche:sco:common
type	DatoAN_Type
facets	Kind Value pattern ([0-9A-Z\-\"]{1}([0-9A-Z&#39; \-\ \. / \^\(\ \)\À É È Ì Ò Ù Û " \ \ /+)*

element **Domicilio_Ita_Type/Provincia**

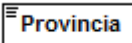
diagram	
namespace	urn:www.agenziaentrategov.it:specificheTecniche:sco:common
type	PR_Type

element **Domicilio_Ita_Type/CodiceComune**

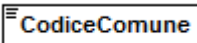
diagram	
namespace	urn:www.agenziaentrategov.it:specificheTecniche:sco:common
type	DatoAN_Type
facets	Kind Value pattern ([0-9A-Z\-\"]{1}([0-9A-Z&#39; \-\ \. / \^\(\ \)\À É È Ì Ò Ù Û " \ \ /+)*

element **Domicilio_Ita_Type/Indirizzo**

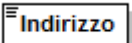
diagram	
namespace	urn:www.agenziaentrategov.it:specificheTecniche:sco:common
type	DatoAN_Type
facets	Kind Value pattern ([0-9A-Z\-\"]{1}([0-9A-Z&#39; \-\ \. / \^\(\ \)\À É È Ì Ò Ù Û " \ \ /+)*

element **Domicilio_Ita_Type/Cap**

diagram	
namespace	urn:www.agenziaentrategov.it:specificheTecniche:sco:common
type	DatoCP_Type
facets	Kind Value pattern [0-9]{5}

complexType Firma_Revisione_Type

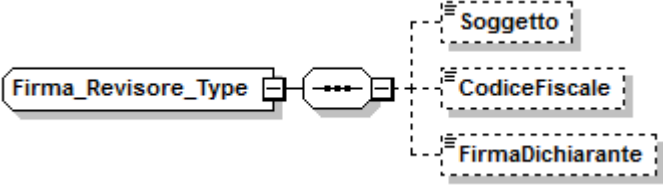
diagram	
namespace	urn:www.agenziaentrate.gov.it:specificheTecniche:sco:common
children	Soggetto CodiceFiscale FirmaDichiarante

element Firma_Revisione_Type/Soggetto

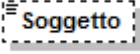
diagram					
namespace	urn:www.agenziaentrate.gov.it:specificheTecniche:sco:common				
type	restriction of DatoNP_Type				
facets	<table border="1"> <tr> <td>Kind</td> <td>Value</td> </tr> <tr> <td>pattern</td> <td>[1-4]</td> </tr> </table>	Kind	Value	pattern	[1-4]
Kind	Value				
pattern	[1-4]				

element Firma_Revisione_Type/CodiceFiscale

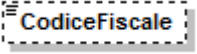
diagram					
namespace	urn:www.agenziaentrate.gov.it:specificheTecniche:sco:common				
type	DatoCF_Type				
facets	<table border="1"> <tr> <td>Kind</td> <td>Value</td> </tr> <tr> <td>pattern</td> <td>[0-9]{11}[A-Z]{6}[0-9LMNPQRSTU]{2}[A-Z]{1}[0-9LMNPQRSTU]{2}[A-Z]{1}[0-9LMNPQRSTU]{3}[A-Z]{1}</td> </tr> </table>	Kind	Value	pattern	[0-9]{11}[A-Z]{6}[0-9LMNPQRSTU]{2}[A-Z]{1}[0-9LMNPQRSTU]{2}[A-Z]{1}[0-9LMNPQRSTU]{3}[A-Z]{1}
Kind	Value				
pattern	[0-9]{11}[A-Z]{6}[0-9LMNPQRSTU]{2}[A-Z]{1}[0-9LMNPQRSTU]{2}[A-Z]{1}[0-9LMNPQRSTU]{3}[A-Z]{1}				

element Firma_Revisione_Type/FirmaDichiarante

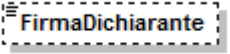
diagram					
namespace	urn:www.agenziaentrate.gov.it:specificheTecniche:sco:common				
type	DatoCB_Type				
facets	<table border="1"> <tr> <td>Kind</td> <td>Value</td> </tr> <tr> <td>pattern</td> <td>[01]</td> </tr> </table>	Kind	Value	pattern	[01]
Kind	Value				
pattern	[01]				

complexType Firma_Type

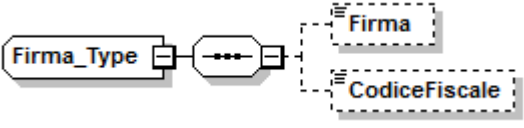
diagram	
namespace	urn:www.agenziaentrate.gov.it:specificheTecniche:sco:common
children	Firma CodiceFiscale

element Firma_Type/Firma

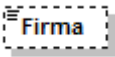
diagram	
namespace	urn:www.agenziaentrate.gov.it:specificheTecniche:sco:common
type	DatoCB_Type
facets	Kind Value pattern [01]

element Firma_Type/CodiceFiscale

diagram	
namespace	urn:www.agenziaentrate.gov.it:specificheTecniche:sco:common
type	restriction of xs:string
facets	Kind Value pattern ([0-9A-Z-])"{0,1}([0-9A-Z&#x2011;] ' \\- \\. \\s / ^\\^\\(\\) À É È Ì Ò Ù Ü " \\N \\ +)*

complexType Frontespizio_Type

diagram	
namespace	urn:www.agenziaentrate.gov.it:specificheTecniche:sco:common
children	SoggettoFiscale

element Frontespizio_Type/SoggettoFiscale

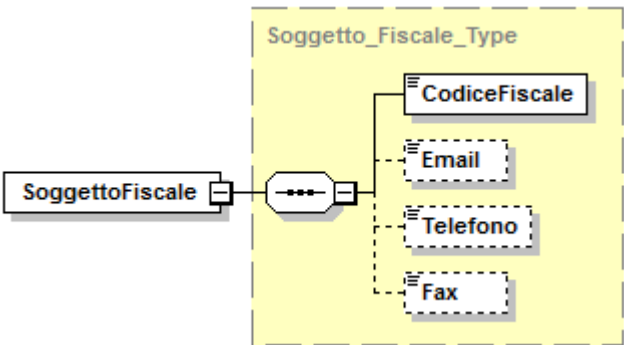
diagram	
namespace	urn:www.agenziaentrate.gov.it:specificheTecniche:sco:common
type	Soggetto_Fiscale_Type
children	CodiceFiscale Email Telefono Fax

complexType Impegno_A_Trasmettere_Type

diagram	
namespace	urn:www.agenziaentrate.gov.it:specificheTecniche:sco:common
children	CFintermediario NumerolscrAlboCAF ImpegnoATrasmettere RicezioneAvvisoTelem DataImpegno FirmaIntermediario

element Impegno_A_Trasmettere_Type/CFintermediario

diagram					
namespace	urn:www.agenziaentrate.gov.it:specificheTecniche:sco:common				
type	DatoCF_Type				
facets	<table border="1"> <thead> <tr> <th>Kind</th> <th>Value</th> </tr> </thead> <tbody> <tr> <td>pattern</td> <td>[0-9]{11}[A-Z]{6}[0-9LMNPQRSTU]{2}[A-Z]{1}[0-9LMNPQRSTU]{2}[A-Z]{1}[0-9LMNPQRSTU]{3}[A-Z]{1}</td> </tr> </tbody> </table>	Kind	Value	pattern	[0-9]{11}[A-Z]{6}[0-9LMNPQRSTU]{2}[A-Z]{1}[0-9LMNPQRSTU]{2}[A-Z]{1}[0-9LMNPQRSTU]{3}[A-Z]{1}
Kind	Value				
pattern	[0-9]{11}[A-Z]{6}[0-9LMNPQRSTU]{2}[A-Z]{1}[0-9LMNPQRSTU]{2}[A-Z]{1}[0-9LMNPQRSTU]{3}[A-Z]{1}				

element Impegno_A_Trasmettere_Type/NumerolscrAlboCAF

diagram					
namespace	urn:www.agenziaentrate.gov.it:specificheTecniche:sco:common				
type	restriction of DatoNU_Type				
facets	<table border="1"> <thead> <tr> <th>Kind</th> <th>Value</th> </tr> </thead> <tbody> <tr> <td>pattern</td> <td>(\-[1-9] [1-9])[0-9]*</td> </tr> </tbody> </table>	Kind	Value	pattern	(\-[1-9] [1-9])[0-9]*
Kind	Value				
pattern	(\-[1-9] [1-9])[0-9]*				

element Impegno_A_Trasmettere_Type/ImpegnoATrasmettere

diagram									
namespace	urn:www.agenziaentrate.gov.it:specificheTecniche:sco:common								
type	restriction of DatoNP_Type								
facets	<table border="1"> <thead> <tr> <th>Kind</th> <th>Value</th> </tr> </thead> <tbody> <tr> <td>pattern</td> <td>1 2</td> </tr> <tr> <td>enumeration</td> <td>1</td> </tr> <tr> <td>enumeration</td> <td>2</td> </tr> </tbody> </table>	Kind	Value	pattern	1 2	enumeration	1	enumeration	2
Kind	Value								
pattern	1 2								
enumeration	1								
enumeration	2								

element **Impegno_A_Trasmettere_Type/RicezioneAvvisoTelem**

diagram	
namespace	urn:www.agenziaentrate.gov.it:specificheTecniche:sco:common
type	DatoCB_Type
facets	Kind Value pattern [01]

element **Impegno_A_Trasmettere_Type/DataImpegno**

diagram	
namespace	urn:www.agenziaentrate.gov.it:specificheTecniche:sco:common
type	DatoDT_Type
facets	Kind Value pattern (((([01-9][12][0-9]3[01])(0[13578]10[12](\d{4})) ((([0][1-9][12][0-9]30)(0[469]11)(\d{4})) ((0[1-9]1[0-9]2[0-8])(02)(\d{4})) ((29)(02)([02468][048]00)) ((29)(02)([13579][26]00)) ((29)(02)([0-9][0-9][048])) ((29)(02)([0-9][0-9][2468][048])) ((29)(02)([0-9][0-9][13579][26])))))

element **Impegno_A_Trasmettere_Type/FirmaIntermediario**

diagram	
namespace	urn:www.agenziaentrate.gov.it:specificheTecniche:sco:common
type	DatoCB_Type
facets	Kind Value pattern [01]

complexType **Persone_Fisiche_Type**

diagram	
namespace	urn:www.agenziaentrate.gov.it:specificheTecniche:sco:common
children	DatiAnagrafici ResidenzaAnagrafica

element **Persone_Fisiche_Type/DatiAnagrafici**

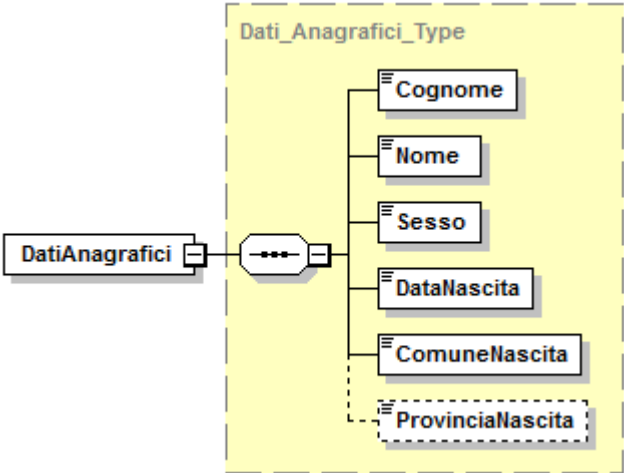
<p>diagram</p>	
<p>namespace</p>	<p>urn:www.agenziaentrate.gov.it:specificheTecniche:sco:common</p>
<p>type</p>	<p>Dati_Anagrafici_Type</p>
<p>children</p>	<p>Cognome Nome Sesso DataNascita ComuneNascita ProvinciaNascita</p>

element **Persone_Fisiche_Type/ResidenzaAnagrafica**

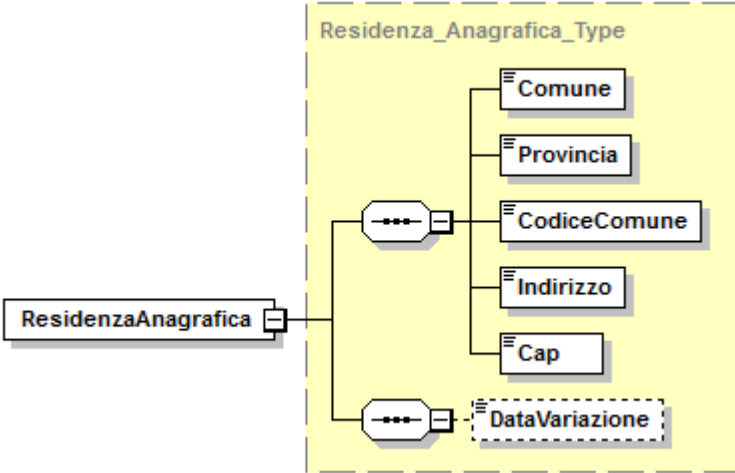
<p>diagram</p>	
<p>namespace</p>	<p>urn:www.agenziaentrate.gov.it:specificheTecniche:sco:common</p>
<p>type</p>	<p>Residenza_Anagrafica_Type</p>
<p>children</p>	<p>Comune Provincia CodiceComune Indirizzo Cap DataVariazione</p>

complexType **Residenza_Anagrafica_Type**

diagram	
namespace	urn:www.agenziaentrate.gov.it:specificheTecniche:sco:common
type	extension of Domicilio_Ita_Type
children	Comune Provincia CodiceComune Indirizzo Cap DataVariazione

element **Residenza_Anagrafica_Type/DataVariazione**

diagram					
namespace	urn:www.agenziaentrate.gov.it:specificheTecniche:sco:common				
type	DatoDT_Type				
facets	<table border="0"> <thead> <tr> <th>Kind</th> <th>Value</th> </tr> </thead> <tbody> <tr> <td>pattern</td> <td>((([0-9]{1,2} [12][0-9] 301 013578 1012)\d{4}) ([0-9]{1,2} [12][0-9] 30 0469 11)\d{4}) ([0-9]{1,2} [0-8])\d{4} ((29 02)(02468 048 00)) ((29 02)(13579 26 00)) ((29 02)([0-9] 0148)) ((29 02)([0-9] 0-9 2468 048)) ((29 02)([0-9] 0-9 13579 26)))</td> </tr> </tbody> </table>	Kind	Value	pattern	((([0-9]{1,2} [12][0-9] 301 013578 1012)\d{4}) ([0-9]{1,2} [12][0-9] 30 0469 11)\d{4}) ([0-9]{1,2} [0-8])\d{4} ((29 02)(02468 048 00)) ((29 02)(13579 26 00)) ((29 02)([0-9] 0148)) ((29 02)([0-9] 0-9 2468 048)) ((29 02)([0-9] 0-9 13579 26)))
Kind	Value				
pattern	((([0-9]{1,2} [12][0-9] 301 013578 1012)\d{4}) ([0-9]{1,2} [12][0-9] 30 0469 11)\d{4}) ([0-9]{1,2} [0-8])\d{4} ((29 02)(02468 048 00)) ((29 02)(13579 26 00)) ((29 02)([0-9] 0148)) ((29 02)([0-9] 0-9 2468 048)) ((29 02)([0-9] 0-9 13579 26)))				

complexType **Residenza_Estera_Type**

diagram	
namespace	urn:www.agenziaentrate.gov.it:specificheTecniche:sco:common
children	CodiceStatoEstero StatoFederato LocalitaEstero IndirizzoEstero

element **Residenza_Estera_Type/CodiceStatoEstero**

diagram	
namespace	urn:www.agenziaentrate.gov.it:specificheTecniche:sco:common
type	restriction of DatoAN_Type
facets	Kind Value pattern ([0-9A-Z\-\]*)"}{1}([0-9A-Z&:] \-\ \., / ^ \^\(\ \)\) À É È Ì Ò Ù Û " \ \ \ +)*

element **Residenza_Estera_Type/StatoFederato**

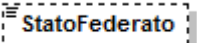
diagram	
namespace	urn:www.agenziaentrate.gov.it:specificheTecniche:sco:common
type	restriction of DatoAN_Type
facets	Kind Value pattern ([0-9A-Z\-\]*)"}{1}([0-9A-Z&:] \-\ \., / ^ \^\(\ \)\) À É È Ì Ò Ù Û " \ \ \ +)*

element **Residenza_Estera_Type/LocalitaEstero**

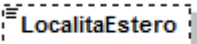
diagram	
namespace	urn:www.agenziaentrate.gov.it:specificheTecniche:sco:common
type	DatoAN_Type
facets	Kind Value pattern ([0-9A-Z\-\]*)"}{1}([0-9A-Z&:] \-\ \., / ^ \^\(\ \)\) À É È Ì Ò Ù Û " \ \ \ +)*

element **Residenza_Estera_Type/IndirizzoEstero**

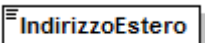
diagram	
namespace	urn:www.agenziaentrate.gov.it:specificheTecniche:sco:common
type	DatoAN_Type
facets	Kind Value pattern ([0-9A-Z\-\]*)"}{1}([0-9A-Z&:] \-\ \., / ^ \^\(\ \)\) À É È Ì Ò Ù Û " \ \ \ +)*

complexType **Soggetti_Diversi_Da_PF_Type**

diagram	
namespace	urn:www.agenziaentrate.gov.it:specificheTecniche:sco:common
children	Denominazione SedeLegale DomicilioFiscale DataApprovazioneBilancio TermineApprovazioneBilancio InizioPeriodoImposta FinePeriodoImposta Stato NaturaGiuridica Situazione

element **Soggetti_Diversi_Da_PF_Type/Denominazione**

diagram					
namespace	urn:www.agenziaentrate.gov.it:specificheTecniche:sco:common				
type	DatoAN_Type				
facets	<table border="0"> <tr> <td>Kind</td> <td>Value</td> </tr> <tr> <td>pattern</td> <td>(([0-9A-Z-] \&quot;){1}([0-9A-Z&amp;#39; "- \., / "^\(\)\ À É È Ì Ò Ù Û &quot; \ \\ +)*</td> </tr> </table>	Kind	Value	pattern	(([0-9A-Z-] \"){1}([0-9A-Z&#39; "- \., / "^\(\)\ À É È Ì Ò Ù Û " \ \\ +)*
Kind	Value				
pattern	(([0-9A-Z-] \"){1}([0-9A-Z&#39; "- \., / "^\(\)\ À É È Ì Ò Ù Û " \ \\ +)*				

element **Soggetti_Diversi_Da_PF_Type/SedeLegale**

diagram	
namespace	urn:www.agenziaentrate.gov.it:specificheTecniche:sco:common
type	Domicilio_EE_Type
children	Comune Provincia CodiceComune Indirizzo Cap DataVariazione

element **Soggetti_Diversi_Da_PF_Type/DomicilioFiscale**

diagram	
namespace	urn:www.agenziaentrate.gov.it:specificheTecniche:sco:common
type	Domicilio_Fiscale_Type
children	Comune Provincia CodiceComune Indirizzo Cap DataVariazione

element **Soggetti_Diversi_Da_PF_Type/DataApprovazioneBilancio**

diagram	
namespace	urn:www.agenziaentrate.gov.it:specificheTecniche:sco:common
type	DatoDT_Type

facets	Kind	Value
	pattern	((([0-9]{1,2}[0-9]{3,4}) (0[13578][10]12)\d{4}))((([0-9]{1,2}[0-9]{3,4}) (0[469][11]\d{4}))((([0-9]{1,2}[0-9]{2}[0-8])(02)\d{4})) ((29)(02)([02468][048]00)) ((29)(02)([13579][26]00)) ((29)(02)([0-9][0-9][0][48])) ((29)(02)([0-9][0-9][2468][048])) ((29)(02)([0-9][0-9][13579][26]))))

element **Soggetti_Diversi_Da_PF_Type/TermineApprovazioneBilancio**

diagram		
namespace	urn:www.agenziaentrate.gov.it:specificheTecniche:sco:common	
type	DatoDT_Type	
facets	Kind	Value
	pattern	((([0-9]{1,2}[0-9]{3,4}) (0[13578][10]12)\d{4}))((([0-9]{1,2}[0-9]{3,4}) (0[469][11]\d{4}))((([0-9]{1,2}[0-9]{2}[0-8])(02)\d{4})) ((29)(02)([02468][048]00)) ((29)(02)([13579][26]00)) ((29)(02)([0-9][0-9][0][48])) ((29)(02)([0-9][0-9][2468][048])) ((29)(02)([0-9][0-9][13579][26]))))

element **Soggetti_Diversi_Da_PF_Type/InizioPeriodoImposta**

diagram		
namespace	urn:www.agenziaentrate.gov.it:specificheTecniche:sco:common	
type	DatoDT_Type	
facets	Kind	Value
	pattern	((([0-9]{1,2}[0-9]{3,4}) (0[13578][10]12)\d{4}))((([0-9]{1,2}[0-9]{3,4}) (0[469][11]\d{4}))((([0-9]{1,2}[0-9]{2}[0-8])(02)\d{4})) ((29)(02)([02468][048]00)) ((29)(02)([13579][26]00)) ((29)(02)([0-9][0-9][0][48])) ((29)(02)([0-9][0-9][2468][048])) ((29)(02)([0-9][0-9][13579][26]))))

element **Soggetti_Diversi_Da_PF_Type/FinePeriodoImposta**

diagram		
namespace	urn:www.agenziaentrate.gov.it:specificheTecniche:sco:common	
type	DatoDT_Type	
facets	Kind	Value
	pattern	((([0-9]{1,2}[0-9]{3,4}) (0[13578][10]12)\d{4}))((([0-9]{1,2}[0-9]{3,4}) (0[469][11]\d{4}))((([0-9]{1,2}[0-9]{2}[0-8])(02)\d{4})) ((29)(02)([02468][048]00)) ((29)(02)([13579][26]00)) ((29)(02)([0-9][0-9][0][48])) ((29)(02)([0-9][0-9][2468][048])) ((29)(02)([0-9][0-9][13579][26]))))

element **Soggetti_Diversi_Da_PF_Type/Stato**

diagram		
namespace	urn:www.agenziaentrate.gov.it:specificheTecniche:sco:common	
type	Stato_Type	
facets	Kind	Value
	pattern	[1-9]{1}[0-9]*
	enumeration	1
	enumeration	2
	enumeration	3
	enumeration	4

element **Soggetti_Diversi_Da_PF_Type/NaturaGiuridica**

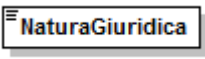
diagram		
namespace	urn:www.agenziaentrate.gov.it:specificheTecniche:sco:common	
type	Natura Giuridica Type	
facets	Kind	Value
	pattern	[1-9]{1}[0-9]*
	enumeration	1
	enumeration	2
	enumeration	3
	enumeration	4
	enumeration	5
	enumeration	6
	enumeration	7
	enumeration	8
	enumeration	9
	enumeration	10
	enumeration	11
	enumeration	12
	enumeration	13
	enumeration	14
	enumeration	15
	enumeration	16
	enumeration	17
	enumeration	18
	enumeration	19
	enumeration	20
	enumeration	21
	enumeration	22
	enumeration	23
	enumeration	24
	enumeration	25
	enumeration	26
	enumeration	27
	enumeration	28
	enumeration	29
	enumeration	30
	enumeration	31
	enumeration	32
	enumeration	33
	enumeration	34
	enumeration	35
	enumeration	36
	enumeration	37
	enumeration	38
	enumeration	39
	enumeration	40
	enumeration	41
	enumeration	42
	enumeration	43
	enumeration	44
	enumeration	45
	enumeration	50
	enumeration	51
	enumeration	52
	enumeration	53
	enumeration	54
	enumeration	55
	enumeration	56
	enumeration	57
	enumeration	58
	enumeration	59

element **Soggetti_Diversi_Da_PF_Type/Situazione**

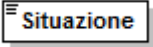
diagram																			
namespace	urn:www.agenziaentrate.gov.it:specificheTecniche:sco:common																		
type	Situazione_Type																		
facets	<table border="1"> <thead> <tr> <th>Kind</th> <th>Value</th> </tr> </thead> <tbody> <tr> <td>pattern</td> <td>[1-9]{1}[0-9]*</td> </tr> <tr> <td>enumeration</td> <td>1</td> </tr> <tr> <td>enumeration</td> <td>2</td> </tr> <tr> <td>enumeration</td> <td>3</td> </tr> <tr> <td>enumeration</td> <td>4</td> </tr> <tr> <td>enumeration</td> <td>5</td> </tr> <tr> <td>enumeration</td> <td>6</td> </tr> <tr> <td>enumeration</td> <td>7</td> </tr> </tbody> </table>	Kind	Value	pattern	[1-9]{1}[0-9]*	enumeration	1	enumeration	2	enumeration	3	enumeration	4	enumeration	5	enumeration	6	enumeration	7
Kind	Value																		
pattern	[1-9]{1}[0-9]*																		
enumeration	1																		
enumeration	2																		
enumeration	3																		
enumeration	4																		
enumeration	5																		
enumeration	6																		
enumeration	7																		

complexType **Soggetti_Non_Residenti_Type**

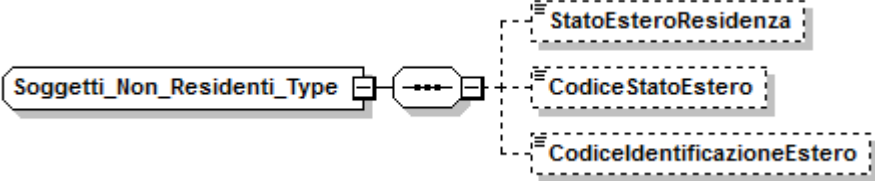
diagram	
namespace	urn:www.agenziaentrate.gov.it:specificheTecniche:sco:common
children	StatoEsteroSede CodiceStatoEsteroSede CodicelIdentificazioneEsteroSede

element **Soggetti_Non_Residenti_Type/StatoEsteroSede**

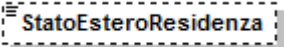
diagram					
namespace	urn:www.agenziaentrate.gov.it:specificheTecniche:sco:common				
type	DatoAN_Type				
facets	<table border="1"> <thead> <tr> <th>Kind</th> <th>Value</th> </tr> </thead> <tbody> <tr> <td>pattern</td> <td>(([0-9A-Z-] \&quot;){1}([0-9A-Z&amp;:] \- \., / ^*\^\(\ \)\^ À È É Ì Ò Ù Û &quot; \ \ /+)*</td> </tr> </tbody> </table>	Kind	Value	pattern	(([0-9A-Z-] \"){1}([0-9A-Z&:] \- \., / ^*\^\(\ \)\^ À È É Ì Ò Ù Û " \ \ /+)*
Kind	Value				
pattern	(([0-9A-Z-] \"){1}([0-9A-Z&:] \- \., / ^*\^\(\ \)\^ À È É Ì Ò Ù Û " \ \ /+)*				

element **Soggetti_Non_Residenti_Type/CodiceStatoEsteroSede**

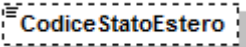
diagram					
namespace	urn:www.agenziaentrate.gov.it:specificheTecniche:sco:common				
type	DatoAN_Type				
facets	<table border="1"> <thead> <tr> <th>Kind</th> <th>Value</th> </tr> </thead> <tbody> <tr> <td>pattern</td> <td>(([0-9A-Z-] \&quot;){1}([0-9A-Z&amp;:] \- \., / ^*\^\(\ \)\^ À È É Ì Ò Ù Û &quot; \ \ /+)*</td> </tr> </tbody> </table>	Kind	Value	pattern	(([0-9A-Z-] \"){1}([0-9A-Z&:] \- \., / ^*\^\(\ \)\^ À È É Ì Ò Ù Û " \ \ /+)*
Kind	Value				
pattern	(([0-9A-Z-] \"){1}([0-9A-Z&:] \- \., / ^*\^\(\ \)\^ À È É Ì Ò Ù Û " \ \ /+)*				

element **Soggetti_Non_Residenti_Type/CodicelIdentificazioneEestero**

diagram	
namespace	urn:www.agenziaentrate.gov.it:specificheTecniche:sco:common
type	DatoAN_Type
facets	Kind Value pattern ([0-9A-Z-]*)"){1}([0-9A-Z&:] ' - \., / ^ \(\) \) À É Ì Ò Ù Ü " \ \\ / +)*

complexType **Soggetto_Fiscale_Type**

diagram	
namespace	urn:www.agenziaentrate.gov.it:specificheTecniche:sco:common
children	CodiceFiscale Email Telefono Fax

element **Soggetto_Fiscale_Type/CodiceFiscale**

diagram	
namespace	urn:www.agenziaentrate.gov.it:specificheTecniche:sco:common
type	DatoCF_Type
facets	Kind Value pattern [0-9]{11}[A-Z]{6}[0-9LMNPQRSTUUV]{2}[A-Z]{1}[0-9LMNPQRSTUUV]{2}[A-Z]{1}[0-9LMNPQRSTUUV]{3}[A-Z]{1}

element **Soggetto_Fiscale_Type/Email**

diagram	
namespace	urn:www.agenziaentrate.gov.it:specificheTecniche:sco:common
type	DatoEM_Type
facets	Kind Value pattern [a-zA-Z0-9._%"?^~=]+@[a-zA-Z0-9.\-].{2,4}

element **Soggetto_Fiscale_Type/Telefono**

diagram	
namespace	urn:www.agenziaentrate.gov.it:specificheTecniche:sco:common
type	DatoTL_Type

facets	Kind pattern	Value [0-9]*
--------	-----------------	-----------------

element **Soggetto_Fiscale_Type/Fax**

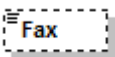
diagram		
namespace	urn:www.agenziaentrate.gov.it:specificheTecniche:sco:common	
type	DatoTL_Type	
facets	Kind pattern	Value [0-9]*

complexType **Tipo_Dichiarazione_Type**

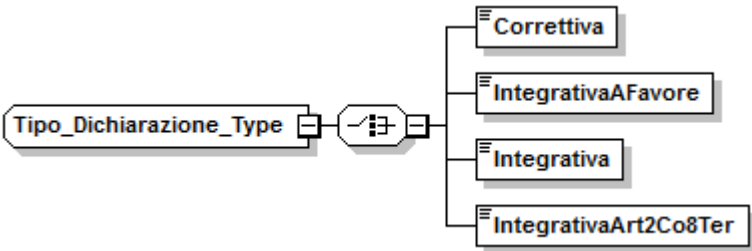
diagram		
namespace	urn:www.agenziaentrate.gov.it:specificheTecniche:sco:common	
children	Correttiva IntegrativaAFavore Integrativa IntegrativaArt2Co8Ter	

element **Tipo_Dichiarazione_Type/Correttiva**

diagram		
namespace	urn:www.agenziaentrate.gov.it:specificheTecniche:sco:common	
type	DatoCB_Type	
facets	Kind pattern	Value [01]

element **Tipo_Dichiarazione_Type/IntegrativaAFavore**

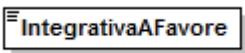
diagram		
namespace	urn:www.agenziaentrate.gov.it:specificheTecniche:sco:common	
type	DatoCB_Type	
facets	Kind pattern	Value [01]

element **Tipo_Dichiarazione_Type/Integrativa**

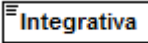
diagram	
namespace	urn:www.agenziaentrate.gov.it:specificheTecniche:sco:common
type	DatoCB_Type
facets	Kind Value pattern [01]

element **Tipo_Dichiarazione_Type/IntegrativaArt2Co8Ter**

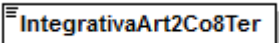
diagram	
namespace	urn:www.agenziaentrate.gov.it:specificheTecniche:sco:common
type	DatoCB_Type
facets	Kind Value pattern [01]

complexType **Visto_Conformita_Type**

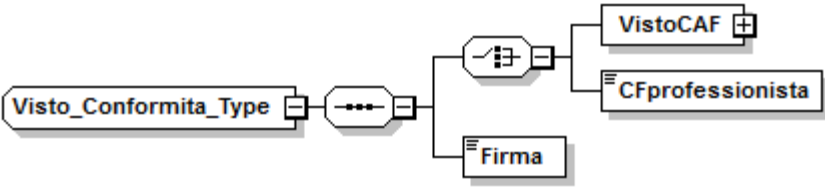
diagram	
namespace	urn:www.agenziaentrate.gov.it:specificheTecniche:sco:common
children	VistoCAF CFprofessionista Firma

element **Visto_Conformita_Type/VistoCAF**

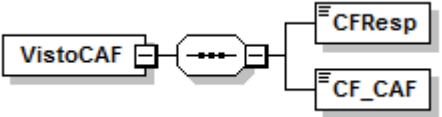
diagram	
namespace	urn:www.agenziaentrate.gov.it:specificheTecniche:sco:common
children	CFResp CF_CAF

element **Visto_Conformita_Type/VistoCAF/CFResp**

diagram	
namespace	urn:www.agenziaentrate.gov.it:specificheTecniche:sco:common
type	DatoCF_Type
facets	Kind Value pattern [0-9]{11}[[A-Z]{6}[0-9LMNPQRSTUUV]{2}[A-Z]{1}[0-9LMNPQRSTUUV]{2}[A-Z]{1}[0-9LMNPQRSTUUV]{3}[A-Z]{1}

element **Visto_Conformita_Type/VistoCAF/CF_CAF**

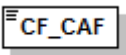
diagram	
namespace	urn:www.agenziaentrate.gov.it:specificheTecniche:sco:common
type	DatoCN_Type
facets	Kind Value pattern [0-9]{11}

element **Visto_Conformita_Type/CFprofessionista**

diagram	
namespace	urn:www.agenziaentrate.gov.it:specificheTecniche:sco:common
type	DatoCF_Type
facets	Kind Value pattern [0-9]{11}[A-Z]{6}[0-9LMNPQRSTUWV]{2}[A-Z]{1}[0-9LMNPQRSTUWV]{2}[A-Z]{1}[0-9LMNPQRSTUWV]{3}[A-Z]{1}

element **Visto_Conformita_Type/Firma**

diagram	
namespace	urn:www.agenziaentrate.gov.it:specificheTecniche:sco:common
type	DatoCB_Type
facets	Kind Value pattern [01]

complexType **Scelta2PerMille_Type**

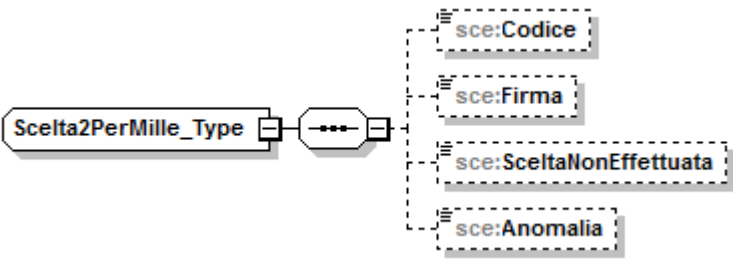
diagram	
namespace	urn:www.agenziaentrate.gov.it:specificheTecniche:sco:sce
children	sce:Codice sce:Firma sce:SceltaNonEffettuata sce:Anomalia

element **Scelta2PerMille_Type/Codice**

diagram	
---------	---

namespace	urn:www.agenziaentrate.gov.it:specificheTecniche:sco:sce				
type	DatoAN_Type				
facets	<table border="1"> <tr> <td>Kind</td> <td>Value</td> </tr> <tr> <td>pattern</td> <td>([0-9A-Z\-_]&quot;){1}([0-9A-Z&amp;:] ' \" \- _ / ' ^\(\\)\ À É È Ì Ò Ù Ú &quot; \\\" \+)*</td> </tr> </table>	Kind	Value	pattern	([0-9A-Z\-_]"){1}([0-9A-Z&:] ' \" \- _ / ' ^\(\\)\ À É È Ì Ò Ù Ú " \\\" \+)*
Kind	Value				
pattern	([0-9A-Z\-_]"){1}([0-9A-Z&:] ' \" \- _ / ' ^\(\\)\ À É È Ì Ò Ù Ú " \\\" \+)*				

element **Scelta2PerMille_Type/Firma**

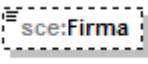
diagram					
namespace	urn:www.agenziaentrate.gov.it:specificheTecniche:sco:sce				
type	DatoCB_Type				
facets	<table border="1"> <tr> <td>Kind</td> <td>Value</td> </tr> <tr> <td>pattern</td> <td>[01]</td> </tr> </table>	Kind	Value	pattern	[01]
Kind	Value				
pattern	[01]				

element **Scelta2PerMille_Type/SceltaNonEffettuata**

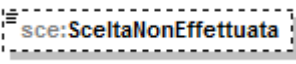
diagram					
namespace	urn:www.agenziaentrate.gov.it:specificheTecniche:sco:sce				
type	DatoCB_Type				
facets	<table border="1"> <tr> <td>Kind</td> <td>Value</td> </tr> <tr> <td>pattern</td> <td>[01]</td> </tr> </table>	Kind	Value	pattern	[01]
Kind	Value				
pattern	[01]				

element **Scelta2PerMille_Type/Anomalia**

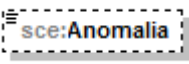
diagram													
namespace	urn:www.agenziaentrate.gov.it:specificheTecniche:sco:sce												
type	restriction of DatoN1_Type												
facets	<table border="1"> <tr> <td>Kind</td> <td>Value</td> </tr> <tr> <td>pattern</td> <td>[1-9]</td> </tr> <tr> <td>enumeration</td> <td>1</td> </tr> <tr> <td>enumeration</td> <td>2</td> </tr> <tr> <td>enumeration</td> <td>3</td> </tr> <tr> <td>enumeration</td> <td>4</td> </tr> </table>	Kind	Value	pattern	[1-9]	enumeration	1	enumeration	2	enumeration	3	enumeration	4
Kind	Value												
pattern	[1-9]												
enumeration	1												
enumeration	2												
enumeration	3												
enumeration	4												

complexType **Scelta2PerMilleAssCult_Type**

diagram	<p>The diagram illustrates the XSD structure for the complex type <code>Scelta2PerMilleAssCult_Type</code>. It is an extension of the <code>sc:Firma_Type</code> (highlighted in yellow). The base type <code>sc:Firma_Type</code> contains two elements: <code>Firma</code> and <code>CodiceFiscale</code>. The extension <code>Scelta2PerMilleAssCult_Type</code> inherits these elements and adds two more: <code>sce:SceltaNonEffettuata</code> and <code>sce:Anomalia</code>.</p>
namespace	urn:www.agenziaentrate.gov.it:specificheTecniche:sco:sce
type	extension of Firma_Type
children	Firma CodiceFiscale sce:SceltaNonEffettuata sce:Anomalia

element **Scelta2PerMilleAssCult_Type/SceltaNonEffettuata**

diagram	<p>The diagram shows the element <code>sce:SceltaNonEffettuata</code> represented as a dashed box with a small icon on the left.</p>				
namespace	urn:www.agenziaentrate.gov.it:specificheTecniche:sco:sce				
type	DatoCB_Type				
facets	<table border="1"> <thead> <tr> <th>Kind</th> <th>Value</th> </tr> </thead> <tbody> <tr> <td>pattern</td> <td>[01]</td> </tr> </tbody> </table>	Kind	Value	pattern	[01]
Kind	Value				
pattern	[01]				

element **Scelta2PerMilleAssCult_Type/Anomalia**

diagram	<p>The diagram shows the element <code>sce:Anomalia</code> represented as a dashed box with a small icon on the left.</p>												
namespace	urn:www.agenziaentrate.gov.it:specificheTecniche:sco:sce												
type	restriction of DatoN1_Type												
facets	<table border="1"> <thead> <tr> <th>Kind</th> <th>Value</th> </tr> </thead> <tbody> <tr> <td>pattern</td> <td>[1-9]</td> </tr> <tr> <td>enumeration</td> <td>1</td> </tr> <tr> <td>enumeration</td> <td>2</td> </tr> <tr> <td>enumeration</td> <td>4</td> </tr> <tr> <td>enumeration</td> <td>5</td> </tr> </tbody> </table>	Kind	Value	pattern	[1-9]	enumeration	1	enumeration	2	enumeration	4	enumeration	5
Kind	Value												
pattern	[1-9]												
enumeration	1												
enumeration	2												
enumeration	4												
enumeration	5												

complexType **Scelta5PerMille_Type**

diagram	
namespace	urn:www.agenziaentrate.gov.it:specificheTecniche:sco:sce
children	sce:SostegnoVolontariatoNonLucrative sce:RicercaScientifica sce:RicercaSanitaria sce:BeniCulturaliPaesaggistici sce:SostegnoSocialeComune sce:SostegnoAssociazioniSportive sce:SceltaNonEffettuata sce:Anomalia sce:FlagAnomaliaCFbeneficiario

element **Scelta5PerMille_Type/SostegnoVolontariatoNonLucrative**

diagram	
namespace	urn:www.agenziaentrate.gov.it:specificheTecniche:sco:sce
type	Firma_Type
children	Firma CodiceFiscale

element **Scelta5PerMille_Type/RicercaScientifica**

diagram	
namespace	urn:www.agenziaentrate.gov.it:specificheTecniche:sco:sce
type	Firma_Type

children	Firma CodiceFiscale
----------	-------------------------------------

element **Scelta5PerMille_Type/RicercaSanitaria**

diagram	
namespace	urn:www.agenziaentrate.gov.it:specificheTecniche:sco:sce
type	Firma_Type
children	Firma CodiceFiscale

element **Scelta5PerMille_Type/BeniCulturaliPaesaggistici**

diagram	
namespace	urn:www.agenziaentrate.gov.it:specificheTecniche:sco:sce
type	Firma_Type
children	Firma CodiceFiscale

element **Scelta5PerMille_Type/SostegnoSocialeComune**

diagram	
namespace	urn:www.agenziaentrate.gov.it:specificheTecniche:sco:sce
children	sce:Firma

element **Scelta5PerMille_Type/SostegnoSocialeComune/Firma**

diagram					
namespace	urn:www.agenziaentrate.gov.it:specificheTecniche:sco:sce				
type	DatoCB_Type				
facets	<table border="1"> <thead> <tr> <th>Kind</th> <th>Value</th> </tr> </thead> <tbody> <tr> <td>pattern</td> <td>[01]</td> </tr> </tbody> </table>	Kind	Value	pattern	[01]
Kind	Value				
pattern	[01]				

element **Scelta5PerMille_Type/SostegnoAssociazioniSportive**

diagram	
namespace	urn:www.agenziaentrate.gov.it:specificheTecniche:sco:sce
type	Firma_Type
children	Firma CodiceFiscale

element **Scelta5PerMille_Type/SceltaNonEffettuata**

diagram					
namespace	urn:www.agenziaentrate.gov.it:specificheTecniche:sco:sce				
type	DatoCB_Type				
facets	<table border="1"> <thead> <tr> <th>Kind</th> <th>Value</th> </tr> </thead> <tbody> <tr> <td>pattern</td> <td>[01]</td> </tr> </tbody> </table>	Kind	Value	pattern	[01]
Kind	Value				
pattern	[01]				

element **Scelta5PerMille_Type/Anomalia**

diagram															
namespace	urn:www.agenziaentrate.gov.it:specificheTecniche:sco:sce														
type	restriction of DatoN1_Type														
facets	<table border="1"> <thead> <tr> <th>Kind</th> <th>Value</th> </tr> </thead> <tbody> <tr> <td>pattern</td> <td>[1-9]</td> </tr> <tr> <td>enumeration</td> <td>1</td> </tr> <tr> <td>enumeration</td> <td>2</td> </tr> <tr> <td>enumeration</td> <td>3</td> </tr> <tr> <td>enumeration</td> <td>4</td> </tr> <tr> <td>enumeration</td> <td>5</td> </tr> </tbody> </table>	Kind	Value	pattern	[1-9]	enumeration	1	enumeration	2	enumeration	3	enumeration	4	enumeration	5
Kind	Value														
pattern	[1-9]														
enumeration	1														
enumeration	2														
enumeration	3														
enumeration	4														
enumeration	5														

element **Scelta5PerMille_Type/FlagAnomaliaCFbeneficiario**

diagram					
namespace	urn:www.agenziaentrate.gov.it:specificheTecniche:sco:sce				
type	DatoCB_Type				
facets	<table border="1"> <thead> <tr> <th>Kind</th> <th>Value</th> </tr> </thead> <tbody> <tr> <td>pattern</td> <td>[01]</td> </tr> </tbody> </table>	Kind	Value	pattern	[01]
Kind	Value				
pattern	[01]				

complexType **Scelta8PerMille_Type**

diagram	
namespace	urn:www.agenziaentrate.gov.it:specificheTecniche:sco:sce
children	sce:Stato sce:ChiesaCattolica sce:UnioneChieseCristianeAvventiste7giorno sce:AssembleeDiDioInItalia sce:UnioneDelleChieseMetodisteValdesi sce:ChiesaEvangelicaLuteranaInItalia sce:UnioneComunitaEbraicheItaliane sce:SacraArcidiocesiOrtodossaEsarcato sce:ChiesaApostolicaitalia sce:UnioneCristianaEvangelicaBattista sce:UnioneBuddhistaitaliana sce:UnioneInduistaitaliana sce:IstitutoBuddistalbisg sce:SceltaNonEffettuata sce:Anomalia

element **Scelta8PerMille_Type/Stato**

diagram					
namespace	urn:www.agenziaentrate.gov.it:specificheTecniche:sco:sce				
type	DatoCB_Type				
facets	<table border="1"> <tr> <td>Kind</td> <td>Value</td> </tr> <tr> <td>pattern</td> <td>[01]</td> </tr> </table>	Kind	Value	pattern	[01]
Kind	Value				
pattern	[01]				

element **Scelta8PerMille_Type/ChiesaCattolica**

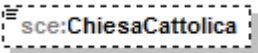
diagram	
namespace	urn:www.agenziaentrate.gov.it:specificheTecniche:sco:sce
type	DatoCB_Type
facets	Kind Value pattern [01]

element **Scelta8PerMille_Type/UnioneChieseCristianeAvventiste7giorno**

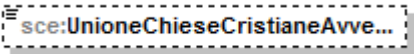
diagram	
namespace	urn:www.agenziaentrate.gov.it:specificheTecniche:sco:sce
type	DatoCB_Type
facets	Kind Value pattern [01]

element **Scelta8PerMille_Type/AssembleeDiDiolnItalia**

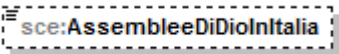
diagram	
namespace	urn:www.agenziaentrate.gov.it:specificheTecniche:sco:sce
type	DatoCB_Type
facets	Kind Value pattern [01]

element **Scelta8PerMille_Type/UnioneDelleChieseMetodisteValdesi**

diagram	
namespace	urn:www.agenziaentrate.gov.it:specificheTecniche:sco:sce
type	DatoCB_Type
facets	Kind Value pattern [01]

element **Scelta8PerMille_Type/ChiesaEvangelicaLuteranaInItalia**

diagram	
namespace	urn:www.agenziaentrate.gov.it:specificheTecniche:sco:sce
type	DatoCB_Type
facets	Kind Value pattern [01]

element **Scelta8PerMille_Type/UnioneComunitaEbraicheItaliane**

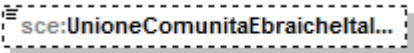
diagram	
namespace	urn:www.agenziaentrate.gov.it:specificheTecniche:sco:sce
type	DatoCB_Type
facets	Kind Value pattern [01]

element **Scelta8PerMille_Type/SacraArcidiocesiOrtodossaEsarcato**

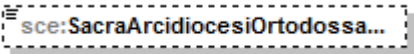
diagram	
namespace	urn:www.agenziaentrate.gov.it:specificheTecniche:sco:sce
type	DatoCB_Type
facets	Kind Value pattern [01]

element **Scelta8PerMille_Type/ChiesaApostolicaItalia**

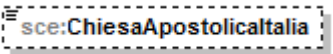
diagram	
namespace	urn:www.agenziaentrate.gov.it:specificheTecniche:sco:sce
type	DatoCB_Type
facets	Kind Value pattern [01]

element **Scelta8PerMille_Type/UnioneCristianaEvangelicaBattista**

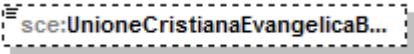
diagram	
namespace	urn:www.agenziaentrate.gov.it:specificheTecniche:sco:sce
type	DatoCB_Type
facets	Kind Value pattern [01]

element **Scelta8PerMille_Type/UnioneBuddhistaitaliana**

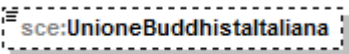
diagram	
namespace	urn:www.agenziaentrate.gov.it:specificheTecniche:sco:sce
type	DatoCB_Type
facets	Kind Value pattern [01]

element **Scelta8PerMille_Type/UnioneInduistaltaliana**

diagram	
namespace	urn:www.agenziaentrate.gov.it:specificheTecniche:sco:sce
type	DatoCB_Type
facets	Kind Value pattern [01]

element **Scelta8PerMille_Type/IstitutoBuddistalbisg**

diagram	
namespace	urn:www.agenziaentrate.gov.it:specificheTecniche:sco:sce
type	DatoCB_Type
facets	Kind Value pattern [01]

element **Scelta8PerMille_Type/SceltaNonEffettuata**

diagram	
namespace	urn:www.agenziaentrate.gov.it:specificheTecniche:sco:sce
type	DatoCB_Type
facets	Kind Value pattern [01]

element **Scelta8PerMille_Type/Anomalia**

diagram	
namespace	urn:www.agenziaentrate.gov.it:specificheTecniche:sco:sce
type	restriction of DatoN1_Type
facets	Kind Value pattern [1-9] enumeration 1 enumeration 2 enumeration 3

complexType **Scelte_Type**

diagram	
---------	--

namespace	urn:www.agenziaentrate.gov.it:specificheTecniche:sco:sce
children	sce:Scelta5PerMille sce:Scelta8PerMille sce:Scelta2PerMille

element **Scelte_Type/Scelta5PerMille**

diagram	<pre> classDiagram class Scelta5PerMille_Type { +SostegnoVolontariatoNonL... +RicercaScientifica +RicercaSanitaria +BeniCulturaliPaesaggistici +SostegnoSocialeComune +SostegnoAssociazioniSpor... +SceltaNonEffettuata +Anomalia +FlagAnomaliaCFbeneficiario } Scelta5PerMille_Type --> SostegnoVolontariatoNonL... Scelta5PerMille_Type --> RicercaScientifica Scelta5PerMille_Type --> RicercaSanitaria Scelta5PerMille_Type --> BeniCulturaliPaesaggistici Scelta5PerMille_Type --> SostegnoSocialeComune Scelta5PerMille_Type --> SostegnoAssociazioniSpor... Scelta5PerMille_Type --> SceltaNonEffettuata Scelta5PerMille_Type --> Anomalia Scelta5PerMille_Type --> FlagAnomaliaCFbeneficiario </pre>
namespace	urn:www.agenziaentrate.gov.it:specificheTecniche:sco:sce
type	sce:Scelta5PerMille_Type
children	sce:SostegnoVolontariatoNonLucrative sce:RicercaScientifica sce:RicercaSanitaria sce:BeniCulturaliPaesaggistici sce:SostegnoSocialeComune sce:SostegnoAssociazioniSportive sce:SceltaNonEffettuata sce:Anomalia sce:FlagAnomaliaCFbeneficiario

element **Scelte_Type/Scelta8PerMille**

<p>diagram</p>	
<p>namespace</p>	<p>urn:www.agenziaentrate.gov.it:specificheTecniche:sco:sce</p>
<p>type</p>	<p>sce:Scelta8PerMille_Type</p>
<p>children</p>	<p>sce:Stato sce:ChiesaCattolica sce:UnioneChieseCristianeAvventiste7giorno sce:AssembleeDiDiolnItalia sce:UnioneDelleChieseMetodisteValdesi sce:ChiesaEvangelicaLuteranaInItalia sce:UnioneComunitaEbraicheitaliane sce:SacraArcidiocesiOrtodossaEsarcato sce:ChiesaApostolicaitalia sce:UnioneCristianaEvangelicaBattista sce:UnioneBuddhistaitaliana sce:UnioneInduistaitaliana sce:IstitutoBuddistalbisg sce:SceltaNonEffettuata sce:Anomalia</p>

element **Scelte_Type/Scelta2PerMille**

diagram	
namespace	urn:www.agenziaentrate.gov.it:specificheTecniche:sco:sce
type	sce:Scelta2PerMille_Type
children	sce:Codice sce:Firma sce:SceltaNonEffettuata sce:Anomalia

simpleType **DatoAN_Type**

namespace	urn:www.agenziaentrate.gov.it:specificheTecniche:common				
type	restriction of xs:string				
facets	<table border="1"> <tr> <td>Kind</td> <td>Value</td> </tr> <tr> <td>pattern</td> <td>([0-9A-Z\-_]&quot;){1}([0-9A-Z&amp;:] ' - \., / ^ \^\(\ \)\À É È Ì Ò Ù Û &quot; \\ / +)*</td> </tr> </table>	Kind	Value	pattern	([0-9A-Z\-_]"){1}([0-9A-Z&:] ' - \., / ^ \^\(\ \)\À É È Ì Ò Ù Û " \\ / +)*
Kind	Value				
pattern	([0-9A-Z\-_]"){1}([0-9A-Z&:] ' - \., / ^ \^\(\ \)\À É È Ì Ò Ù Û " \\ / +)*				

simpleType **DatoCB12_Type**

namespace	urn:www.agenziaentrate.gov.it:specificheTecniche:common				
type	restriction of xs:byte				
facets	<table border="1"> <tr> <td>Kind</td> <td>Value</td> </tr> <tr> <td>pattern</td> <td>[10]{12}</td> </tr> </table>	Kind	Value	pattern	[10]{12}
Kind	Value				
pattern	[10]{12}				

simpleType **DatoCB_Type**

namespace	urn:www.agenziaentrate.gov.it:specificheTecniche:common				
type	restriction of xs:byte				
facets	<table border="1"> <tr> <td>Kind</td> <td>Value</td> </tr> <tr> <td>pattern</td> <td>[01]</td> </tr> </table>	Kind	Value	pattern	[01]
Kind	Value				
pattern	[01]				

simpleType **DatoCF_Type**

namespace	urn:www.agenziaentrate.gov.it:specificheTecniche:common				
type	restriction of xs:string				
facets	<table border="1"> <tr> <td>Kind</td> <td>Value</td> </tr> <tr> <td>pattern</td> <td>[0-9]{11}[A-Z]{6}[0-9LMNPQRSTUWV]{2}[A-Z]{1}[0-9LMNPQRSTUWV]{2}[A-Z]{1}[0-9LMNPQRSTUWV]{3}[A-Z]{1}</td> </tr> </table>	Kind	Value	pattern	[0-9]{11}[A-Z]{6}[0-9LMNPQRSTUWV]{2}[A-Z]{1}[0-9LMNPQRSTUWV]{2}[A-Z]{1}[0-9LMNPQRSTUWV]{3}[A-Z]{1}
Kind	Value				
pattern	[0-9]{11}[A-Z]{6}[0-9LMNPQRSTUWV]{2}[A-Z]{1}[0-9LMNPQRSTUWV]{2}[A-Z]{1}[0-9LMNPQRSTUWV]{3}[A-Z]{1}				

simpleType **DatoCN_Type**

namespace	urn:www.agenziaentrate.gov.it:specificheTecniche:common
-----------	---

type	restriction of xs:string
facets	Kind Value pattern [0-9]{11}

simpleType **DatoCP_Type**

namespace	urn:www.agenziaentrate.gov.it:specificheTecniche:common
type	restriction of xs:string
facets	Kind Value pattern [0-9]{5}

simpleType **DatoD6_Type**

namespace	urn:www.agenziaentrate.gov.it:specificheTecniche:common
type	restriction of xs:string
facets	Kind Value pattern ((0[0-9]) (1[0-2]))((19 20)[0-9][0-9])

simpleType **DatoDA_Type**

namespace	urn:www.agenziaentrate.gov.it:specificheTecniche:common
type	restriction of xs:string
facets	Kind Value pattern (18 19 20)[0-9]{2}

simpleType **DatoDN_Type**

namespace	urn:www.agenziaentrate.gov.it:specificheTecniche:common
type	restriction of xs:string
facets	Kind Value pattern (((([0-9]{12} [0-9]{3}[01]) (0[13578] 10 12)\d{4})) (((0[1-9] 12)[0-9]{30}(0[469] 11)\d{4})) ((0[1-9] 1[0-9] 2[0-8])(02)\d{4})) ((29)(02)([02468][048]00)) ((29)(02)([13579][26]00)) ((29)(02)([0-9][0-9][0][48])) ((29)(02)([0-9][0-9][2468][048])) ((29)(02)([0-9][0-9][13579][26]))))

simpleType **DatoDT_Type**

namespace	urn:www.agenziaentrate.gov.it:specificheTecniche:common
type	restriction of xs:string
facets	Kind Value pattern (((([0-9]{12} [0-9]{3}[01]) (0[13578] 10 12)\d{4})) (((0[1-9] 12)[0-9]{30}(0[469] 11)\d{4})) ((0[1-9] 1[0-9] 2[0-8])(02)\d{4})) ((29)(02)([02468][048]00)) ((29)(02)([13579][26]00)) ((29)(02)([0-9][0-9][0][48])) ((29)(02)([0-9][0-9][2468][048])) ((29)(02)([0-9][0-9][13579][26]))))

simpleType **DatoEM_Type**

namespace	urn:www.agenziaentrate.gov.it:specificheTecniche:common
type	restriction of xs:string
facets	Kind Value pattern [a-zA-Z0-9._%'\-"?^~=]+@[a-zA-Z0-9.\-]+\.[a-zA-Z]{2,4}

simpleType DatoGA_Type

namespace	urn:www.agenziaentrate.gov.it:specificheTecniche:common				
type	restriction of xs:string				
facets	<table border="1"><tr><td>Kind</td><td>Value</td></tr><tr><td>pattern</td><td>[1-9]{1}([1-9][0-9])?([12][0-9][0-9])?(3[0-5][0-9])?(36[0-5])?</td></tr></table>	Kind	Value	pattern	[1-9]{1}([1-9][0-9])?([12][0-9][0-9])?(3[0-5][0-9])?(36[0-5])?
Kind	Value				
pattern	[1-9]{1}([1-9][0-9])?([12][0-9][0-9])?(3[0-5][0-9])?(36[0-5])?				

simpleType DatoN1_Type

namespace	urn:www.agenziaentrate.gov.it:specificheTecniche:common				
type	restriction of xs:string				
facets	<table border="1"><tr><td>Kind</td><td>Value</td></tr><tr><td>pattern</td><td>[1-9]</td></tr></table>	Kind	Value	pattern	[1-9]
Kind	Value				
pattern	[1-9]				

simpleType DatoNP_Type

namespace	urn:www.agenziaentrate.gov.it:specificheTecniche:common				
type	restriction of xs:string				
facets	<table border="1"><tr><td>Kind</td><td>Value</td></tr><tr><td>pattern</td><td>[1-9]{1}[0-9]*</td></tr></table>	Kind	Value	pattern	[1-9]{1}[0-9]*
Kind	Value				
pattern	[1-9]{1}[0-9]*				

simpleType DatoNU_Type

namespace	urn:www.agenziaentrate.gov.it:specificheTecniche:common				
type	restriction of xs:string				
facets	<table border="1"><tr><td>Kind</td><td>Value</td></tr><tr><td>pattern</td><td>(\-[1-9] [1-9])[0-9]*</td></tr></table>	Kind	Value	pattern	(\-[1-9] [1-9])[0-9]*
Kind	Value				
pattern	(\-[1-9] [1-9])[0-9]*				

simpleType DatoPC_Type

namespace	urn:www.agenziaentrate.gov.it:specificheTecniche:common				
type	restriction of xs:string				
facets	<table border="1"><tr><td>Kind</td><td>Value</td></tr><tr><td>pattern</td><td>[0-9]?[0-9](,\d{1,3})?100(,0{1,3})?</td></tr></table>	Kind	Value	pattern	[0-9]?[0-9](,\d{1,3})?100(,0{1,3})?
Kind	Value				
pattern	[0-9]?[0-9](,\d{1,3})?100(,0{1,3})?				

simpleType DatoPI_Type

namespace	urn:www.agenziaentrate.gov.it:specificheTecniche:common				
type	restriction of xs:string				
facets	<table border="1"><tr><td>Kind</td><td>Value</td></tr><tr><td>pattern</td><td>[0-7][0-9]{10}</td></tr></table>	Kind	Value	pattern	[0-7][0-9]{10}
Kind	Value				
pattern	[0-7][0-9]{10}				

simpleType DatoQU_Type

namespace	urn:www.agenziaentrate.gov.it:specificheTecniche:common				
type	restriction of xs:string				
facets	<table border="1"><tr><td>Kind</td><td>Value</td></tr><tr><td>pattern</td><td>[0-9]+(,[0-9]{1,5})?</td></tr></table>	Kind	Value	pattern	[0-9]+(,[0-9]{1,5})?
Kind	Value				
pattern	[0-9]+(,[0-9]{1,5})?				

simpleType **DatoTL_Type**

namespace	urn:www.agenziaentrate.gov.it:specificheTecniche:common				
type	restriction of xs:string				
facets	<table><thead><tr><th>Kind</th><th>Value</th></tr></thead><tbody><tr><td>pattern</td><td>[0-9]*</td></tr></tbody></table>	Kind	Value	pattern	[0-9]*
Kind	Value				
pattern	[0-9]*				

simpleType **DatoVP_Type**

namespace	urn:www.agenziaentrate.gov.it:specificheTecniche:common				
type	restriction of xs:string				
facets	<table><thead><tr><th>Kind</th><th>Value</th></tr></thead><tbody><tr><td>pattern</td><td>[0-9]+,[0-9]{2}</td></tr></tbody></table>	Kind	Value	pattern	[0-9]+,[0-9]{2}
Kind	Value				
pattern	[0-9]+,[0-9]{2}				

simpleType **Casella_Quadro_Type**

namespace	urn:www.agenziaentrate.gov.it:specificheTecniche:sco:common												
type	restriction of DatoAN_Type												
facets	<table><thead><tr><th>Kind</th><th>Value</th></tr></thead><tbody><tr><td>pattern</td><td>(([0-9A-Z-] &quot;){1}([0-9A-Z&amp;] ' \" . / ° \\ \\(\\) À È É Ì Ò Ù Û &quot;; \\ \\ \\ +)*</td></tr><tr><td>enumeration</td><td>0</td></tr><tr><td>enumeration</td><td>1</td></tr><tr><td>enumeration</td><td>2</td></tr><tr><td>enumeration</td><td>3</td></tr></tbody></table>	Kind	Value	pattern	(([0-9A-Z-] "){1}([0-9A-Z&] ' \" . / ° \\ \\(\\) À È É Ì Ò Ù Û "; \\ \\ \\ +)*	enumeration	0	enumeration	1	enumeration	2	enumeration	3
Kind	Value												
pattern	(([0-9A-Z-] "){1}([0-9A-Z&] ' \" . / ° \\ \\(\\) À È É Ì Ò Ù Û "; \\ \\ \\ +)*												
enumeration	0												
enumeration	1												
enumeration	2												
enumeration	3												

simpleType **Codice_Carica_Type**

namespace	urn:www.agenziaentrate.gov.it:specificheTecniche:sco:common																																		
type	restriction of DatoNP_Type																																		
facets	<table><thead><tr><th>Kind</th><th>Value</th></tr></thead><tbody><tr><td>pattern</td><td>[1-9]{1}[0-9]*</td></tr><tr><td>enumeration</td><td>1</td></tr><tr><td>enumeration</td><td>2</td></tr><tr><td>enumeration</td><td>3</td></tr><tr><td>enumeration</td><td>4</td></tr><tr><td>enumeration</td><td>5</td></tr><tr><td>enumeration</td><td>6</td></tr><tr><td>enumeration</td><td>7</td></tr><tr><td>enumeration</td><td>8</td></tr><tr><td>enumeration</td><td>9</td></tr><tr><td>enumeration</td><td>10</td></tr><tr><td>enumeration</td><td>11</td></tr><tr><td>enumeration</td><td>12</td></tr><tr><td>enumeration</td><td>13</td></tr><tr><td>enumeration</td><td>14</td></tr><tr><td>enumeration</td><td>15</td></tr></tbody></table>	Kind	Value	pattern	[1-9]{1}[0-9]*	enumeration	1	enumeration	2	enumeration	3	enumeration	4	enumeration	5	enumeration	6	enumeration	7	enumeration	8	enumeration	9	enumeration	10	enumeration	11	enumeration	12	enumeration	13	enumeration	14	enumeration	15
Kind	Value																																		
pattern	[1-9]{1}[0-9]*																																		
enumeration	1																																		
enumeration	2																																		
enumeration	3																																		
enumeration	4																																		
enumeration	5																																		
enumeration	6																																		
enumeration	7																																		
enumeration	8																																		
enumeration	9																																		
enumeration	10																																		
enumeration	11																																		
enumeration	12																																		
enumeration	13																																		
enumeration	14																																		
enumeration	15																																		

simpleType **Codice_Regione_Type**

namespace	urn:www.agenziaentrate.gov.it:specificheTecniche:sco:common				
type	restriction of DatoAN_Type				
facets	<table><thead><tr><th>Kind</th><th>Value</th></tr></thead><tbody><tr><td>pattern</td><td>(([0-9A-Z-] &quot;){1}([0-9A-Z&amp;] ' \" . / ° \\ \\(\\) À È É Ì Ò Ù Û &quot;; \\ \\ \\ +)*</td></tr></tbody></table>	Kind	Value	pattern	(([0-9A-Z-] "){1}([0-9A-Z&] ' \" . / ° \\ \\(\\) À È É Ì Ò Ù Û "; \\ \\ \\ +)*
Kind	Value				
pattern	(([0-9A-Z-] "){1}([0-9A-Z&] ' \" . / ° \\ \\(\\) À È É Ì Ò Ù Û "; \\ \\ \\ +)*				

	enumeration	1
	enumeration	2
	enumeration	3
	enumeration	4
	enumeration	5
	enumeration	6
	enumeration	7
	enumeration	8
	enumeration	9
	enumeration	10
	enumeration	11
	enumeration	12
	enumeration	13
	enumeration	14
	enumeration	15
	enumeration	16
	enumeration	17
	enumeration	18
	enumeration	19
	enumeration	20
	enumeration	21

simpleType **Natura_Giuridica_Type**

namespace	urn:www.agenziaentrate.gov.it:specificheTecniche:sco:common	
type	restriction of DatoNP_Type	
facets	Kind	Value
	pattern	[1-9]{1}[0-9]*
	enumeration	1
	enumeration	2
	enumeration	3
	enumeration	4
	enumeration	5
	enumeration	6
	enumeration	7
	enumeration	8
	enumeration	9
	enumeration	10
	enumeration	11
	enumeration	12
	enumeration	13
	enumeration	14
	enumeration	15
	enumeration	16
	enumeration	17
	enumeration	18
	enumeration	19
	enumeration	20
	enumeration	21
	enumeration	22
	enumeration	23
	enumeration	24
	enumeration	25
	enumeration	26
	enumeration	27
	enumeration	28
	enumeration	29
	enumeration	30
	enumeration	31
	enumeration	32
	enumeration	33
	enumeration	34
	enumeration	35
	enumeration	36
	enumeration	37
	enumeration	38
	enumeration	39

	enumeration	40
	enumeration	41
	enumeration	42
	enumeration	43
	enumeration	44
	enumeration	45
	enumeration	50
	enumeration	51
	enumeration	52
	enumeration	53
	enumeration	54
	enumeration	55
	enumeration	56
	enumeration	57
	enumeration	58
	enumeration	59

simpleType Sesso_Type

namespace	urn:www.agenziaentrate.gov.it:specificheTecniche:sco:common	
type	restriction of DatoAN_Type	
facets	Kind	Value
	pattern	{([0-9A-Z-])"}{1}([0-9A-Z&:] ' - \. , / ° ^\ \\(\) À È É ì Ò Ù Ü " \ \\ /+)*
	enumeration	M
	enumeration	F

simpleType Situazione_Type

namespace	urn:www.agenziaentrate.gov.it:specificheTecniche:sco:common	
type	restriction of DatoNP_Type	
facets	Kind	Value
	pattern	[1-9]{1}[0-9]*
	enumeration	1
	enumeration	2
	enumeration	3
	enumeration	4
	enumeration	5
	enumeration	6
	enumeration	7

simpleType Stato_Type

namespace	urn:www.agenziaentrate.gov.it:specificheTecniche:sco:common	
type	restriction of DatoNP_Type	
facets	Kind	Value
	pattern	[1-9]{1}[0-9]*
	enumeration	1
	enumeration	2
	enumeration	3
	enumeration	4

simpleType Eventi_Ecc_Type

namespace	urn:www.agenziaentrate.gov.it:specificheTecniche:sco:common	
type	restriction of xs:string	
facets	Kind	Value
	enumeration	1

	enumeration	2
	enumeration	3
	enumeration	4

simpleType **Estero**

namespace	urn:www.agenziaentrate.gov.it:specificheTecniche:common	
type	restriction of xs:string	
facets	Kind	Value
	enumeration	EE

simpleType **PE_Type**

namespace	urn:www.agenziaentrate.gov.it:specificheTecniche:common	
type	union of (ProvinciItaliane , Estero)	

simpleType **PN_Type**

namespace	urn:www.agenziaentrate.gov.it:specificheTecniche:common	
type	union of (ProvinciItaliane , ProvincieCroate , Estero , ProvincieSoppresse)	

simpleType **PR_Type**

namespace	urn:www.agenziaentrate.gov.it:specificheTecniche:common	
type	union of (ProvinciItaliane)	

simpleType **ProvincieCroate**

namespace	urn:www.agenziaentrate.gov.it:specificheTecniche:common	
type	restriction of xs:string	
facets	Kind	Value
	enumeration	FU
	enumeration	PL
	enumeration	ZA

simpleType **ProvinciItaliane**

namespace	urn:www.agenziaentrate.gov.it:specificheTecniche:common	
type	restriction of xs:string	
facets	Kind	Value
	enumeration	AG
	enumeration	AL
	enumeration	AN
	enumeration	AO
	enumeration	AP
	enumeration	AQ
	enumeration	AR
	enumeration	AT
	enumeration	AV
	enumeration	BA
	enumeration	BG

enumeration	BI
enumeration	BL
enumeration	BN
enumeration	BO
enumeration	BR
enumeration	BS
enumeration	BT
enumeration	BZ
enumeration	CA
enumeration	CB
enumeration	CE
enumeration	CH
enumeration	CI
enumeration	CL
enumeration	CN
enumeration	CO
enumeration	CR
enumeration	CS
enumeration	CT
enumeration	CZ
enumeration	EN
enumeration	FC
enumeration	FE
enumeration	FG
enumeration	FI
enumeration	FM
enumeration	FR
enumeration	GE
enumeration	GO
enumeration	GR
enumeration	IM
enumeration	IS
enumeration	KR
enumeration	LC
enumeration	LE
enumeration	LI
enumeration	LO
enumeration	LT
enumeration	LU
enumeration	MB
enumeration	MC
enumeration	ME
enumeration	MI
enumeration	MN
enumeration	MO
enumeration	MS
enumeration	MT
enumeration	NA
enumeration	NO
enumeration	NU
enumeration	OG
enumeration	OR
enumeration	OT
enumeration	PA
enumeration	PC
enumeration	PD
enumeration	PE
enumeration	PG
enumeration	PI
enumeration	PN
enumeration	PO
enumeration	PR
enumeration	PT
enumeration	PU
enumeration	PV
enumeration	PZ
enumeration	RA
enumeration	RC
enumeration	RE
enumeration	RG

	enumeration	RI
	enumeration	RM
	enumeration	RN
	enumeration	RO
	enumeration	SA
	enumeration	SI
	enumeration	SO
	enumeration	SP
	enumeration	SR
	enumeration	SS
	enumeration	SV
	enumeration	TA
	enumeration	TE
	enumeration	TN
	enumeration	TO
	enumeration	TP
	enumeration	TR
	enumeration	TS
	enumeration	TV
	enumeration	UD
	enumeration	VA
	enumeration	VB
	enumeration	VC
	enumeration	VE
	enumeration	VI
	enumeration	VR
	enumeration	VS
	enumeration	VT
	enumeration	VV

simpleType **ProvinciaSopresse**

namespace	urn:www.agenziaentrate.gov.it:specificheTecniche:common	
type	restriction of xs:string	
facets	Kind	Value
	enumeration	FO
	enumeration	PS

schema location: **fornitura734_2017_v1.xsd**
 attribute form default: **unqualified**
 element form default: **qualified**
 targetNamespace: **urn:www.agenziaentrate.gov.it:specificheTecniche:sco:730**

Elements

[Fornitura730-4](#)

element Fornitura730-4

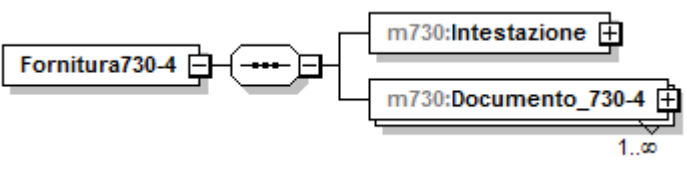
diagram	
namespace	urn:www.agenziaentrate.gov.it:specificheTecniche:sco:730
children	m730:Intestazione m730:Documento_730-4

element Fornitura730-4/Intestazione

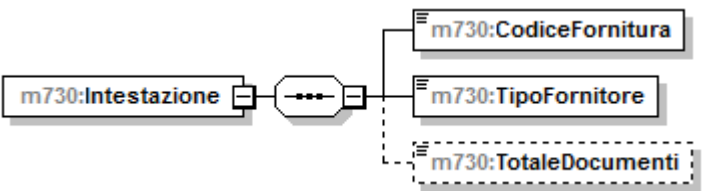
diagram	
namespace	urn:www.agenziaentrate.gov.it:specificheTecniche:sco:730
children	m730:CodiceFornitura m730:TipoFornitore m730:TotaleDocumenti

element Fornitura730-4/Intestazione/CodiceFornitura

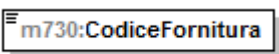
diagram					
namespace	urn:www.agenziaentrate.gov.it:specificheTecniche:sco:730				
type	DatoAN_Type				
facets	<table border="0"> <tr> <td>Kind</td> <td>Value</td> </tr> <tr> <td>pattern</td> <td>(([0-9A-Z-])&quot;){1}([0-9A-Z&amp;:] "- \., / "^\(\ \)\ À È É Ì Ò Ù Û &quot; \\ / +)*</td> </tr> </table>	Kind	Value	pattern	(([0-9A-Z-])"){1}([0-9A-Z&:] "- \., / "^\(\ \)\ À È É Ì Ò Ù Û " \\ / +)*
Kind	Value				
pattern	(([0-9A-Z-])"){1}([0-9A-Z&:] "- \., / "^\(\ \)\ À È É Ì Ò Ù Û " \\ / +)*				

element Fornitura730-4/Intestazione/TipoFornitore

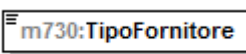
diagram	
namespace	urn:www.agenziaentrate.gov.it:specificheTecniche:sco:730

type	DatoNP_Type	
facets	Kind	Value
	pattern	[1-9]{1}[0-9]*

element Fornitura730-4/Intestazione/TotaleDocumenti

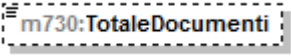
diagram		
namespace	urn:www.agenziaentrate.gov.it:specificheTecniche:sco:730	
type	DatoNP_Type	
facets	Kind	Value
	pattern	[1-9]{1}[0-9]*

element Fornitura730-4/Documento_730-4

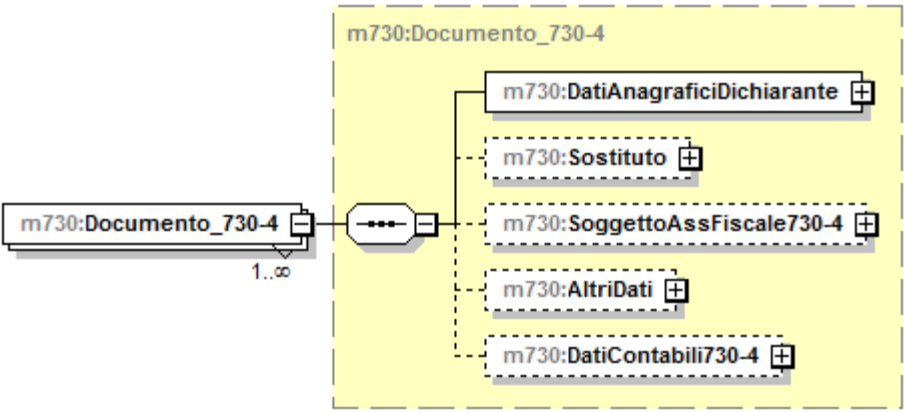
diagram		
namespace	urn:www.agenziaentrate.gov.it:specificheTecniche:sco:730	
type	m730:Documento_730-4	
children	m730:DatiAnagraficiDichiarante m730:Sostituto m730:SoggettoAssFiscale730-4 m730:AltriDati m730:DatiContabili730-4	