

## **ALLEGATO A**

### **Specifiche tecniche per la trasmissione telematica Modello 730/2018**

## INDICE

<b>1</b>	<b>AVVERTENZE GENERALI .....</b>	<b>3</b>
<b>2</b>	<b>BREVI CENNI SUL LINGUAGGIO XML.....</b>	<b>3</b>
<b>3</b>	<b>CONTENUTO DELLA FORNITURA .....</b>	<b>5</b>
3.1	GENERALITÀ.....	5
3.2	COERENZA DEI DATI DELLA DICHIARAZIONE .....	6
3.3	IL TRATTAMENTO DEL CODICE FISCALE .....	6
3.4	SOGGETTO CHE PRESTA L'ASSISTENZA FISCALE .....	7
<b>4</b>	<b>TRASMISSIONE TELEMATICA DEL MOD. 730-4 DA PARTE DEI CAF, DEL PROFESSIONISTA ABILITATO O DI UNA ASSOCIAZIONE PROFESSIONALE ALL'AGENZIA DELLE ENTRATE E DESTINATO AI SOSTITUTI D'IMPOSTA.....</b>	<b>8</b>
4.1	TRASMISSIONE TELEMATICA DEL MOD. 730-4: CASI PARTICOLARI.....	8
4.2	DATI MOD. 730-4 RESI DISPONIBILI DALL'AGENZIA DELLE ENTRATE AI SOSTITUTI O INTERMEDIARI .....	9
<b>5</b>	<b>SPECIFICHE TECNICHE IN FORMATO XML.....</b>	<b>10</b>
5.1	GENERALITÀ SPECIFICHE TECNICHE IN FORMATO XML.....	10
5.1.1	<i>Messaggio</i> .....	10
5.1.2	<i>Intestazione</i> .....	10
5.1.3	<i>Contenuto</i> .....	10
5.1.4	<i>Fornitura</i> .....	11
5.1.5	<i>Intestazione</i> .....	11
5.1.6	<i>Documento 730</i> .....	12
5.2	SPECIFICHE TECNICHE IN FORMATO XML .....	12

# CONTENUTO E CARATTERISTICHE TECNICHE DEI DATI DELLE DICHIARAZIONI DEI REDDITI MODELLO 730/2018 DA INVIARE ALL'AMMINISTRAZIONE FINANZIARIA IN VIA TELEMATICA

## 1 AVVERTENZE GENERALI

I Sostituti d'imposta, i Centri di Assistenza Fiscale, i professionisti abilitati, le società e gli enti di grandi dimensioni, nonché gli intermediari abilitati, trasmettono i dati delle dichiarazioni dei Mod.730, all'**Agenzia delle Entrate** in via telematica.

Il contenuto e le caratteristiche della fornitura dei dati da trasmettere all'Agenzia delle Entrate in via telematica sono riportati nelle specifiche tecniche di seguito esposte.

Si precisa che una dichiarazione da inviare, i cui dati non sono conformi alle indicazioni delle presenti specifiche tecniche, verrà scartata.

Le modalità per la trasmissione dei dati in via telematica sono stabilite con il decreto del 31 luglio 1998 (pubblicato nella G.U. del 12 agosto 1998, n. 187) e successive modificazioni.

## 2 Brevi cenni sul linguaggio XML

L'Agenzia delle Entrate ha scelto di adottare, per la definizione della fornitura relativa alle dichiarazioni 730 2018, il linguaggio XML (eXtensible Markup Language).

L'XML è un metalinguaggio, ossia una "grammatica", per la definizione di documenti da gestire con strumenti informatici.

Per "grammatica" si intende l'insieme standard di definizioni e di regole sintattiche mediante le quali la struttura logica di un documento viene tradotta in una corrispondente struttura fisica, composta di elementi sintattici chiamati **tag**, ossia sequenze di caratteri delimitate dai segni '<' e '>'.

Concretamente, un file XML è un file di testo costituito da diversi **elementi** individuati dai **tag**, ciascuno dei quali identifica un componente logico del documento.

Gli **elementi** sono organizzati secondo una **struttura gerarchica**: ciascun **elemento** può infatti contenere altri elementi (**sottoelementi**) oppure del testo. L'elemento principale della struttura "ad albero" così ottenuta è denominato **radice (root element)**.

Agli **elementi** possono essere associate altre informazioni che ne descrivono le proprietà, tali informazioni sono chiamate **attributi**.

**La modellazione della fornitura delle dichiarazioni 730/2018 è stata realizzata introducendo la radice denominata Messaggio, all'interno della quale sono stati individuati i due sottoelementi Intestazione e Contenuto.**

L'elemento Intestazione espone il codice fiscale del soggetto responsabile dell'invio telematico, l'elemento Contenuto definisce al suo interno una Fornitura astratta che, nel caso del modello 730 2018, assume le caratteristiche di quella ad esso relativa e descritta nel paragrafo 5. L'elemento Contenuto espone l'attributo codiceFornitura che per il suddetto modello deve essere impostato al valore 73018.

**Nel paragrafo 5 vengono fornite ulteriori indicazioni relative agli elementi sopra citati.**

La struttura della fornitura xml è descritta, mediante l'**XML Schema**, in uno specifico documento (**schema document**), identificato dall'estensione "xsd". Il file XSD (XML Schema Definition) delinea il contenuto della fornitura definendone gli elementi ed evidenziandone attributi e relazioni reciproche.

In particolare, lo **schema** relativo alla fornitura xml identifica tre diverse tipologie di componenti: elementi di significato generale, ossia indipendenti dal tipo di documento contenuto nella fornitura stessa, elementi che rappresentano i componenti logici di una generica dichiarazione ed elementi che costituiscono, più specificamente, la struttura di una dichiarazione Modello 730.

Ciascuna delle suddette tipologie di componenti individua un "dominio di nomi" (**namespace**), un ambito nel quale gli elementi sono univoci ed hanno significato omogeneo.

Concretamente, lo schema relativo alla fornitura 730 si compone di un insieme di documenti xsd, associati ai tre diversi namespace, nei quali sono definiti, oltre agli elementi della fornitura, anche i tipi di dati ad essi associati ed alcuni elenchi di codici predefiniti previsti per gli elementi della dichiarazione.

### 3 CONTENUTO DELLA FORNITURA

#### 3.1 Generalità

La fornitura oggetto della trasmissione telematica deve essere conforme alle specifiche dell'eXtensible Markup Language (XML) 1.0 (raccomandazione WC3 10 febbraio 1998) e deve essere codificata secondo la codifica UTF-8.

Il contenuto della fornitura xml, relativa al Modello 730/2018, deve inoltre soddisfare la sintassi descritta nel file XSD denominato “**fornitura730\_2018\_v1.xsd**”, allegato al presente documento.

Il suddetto schema definisce la struttura della fornitura xml, delineando gli elementi permessi, i loro attributi, i tipi di dati ad essi associati e la relazione gerarchica tra gli elementi stessi.

La procedura distribuita dall'Agenzia delle Entrate esegue una prima fase di **validazione** della fornitura, ossia di verifica che il file sia conforme allo schema ad esso associato ed una successiva fase di **controllo**, nella quale esamina la correttezza dei dati indicati applicando regole specifiche per ciascun elemento.

**L'esito negativo della validazione determina lo scarto dell'intera fornitura.**

I diagnostici generati in fase di **controllo** possono avere una diversa gravità a seconda dell'elemento interessato e possono determinare lo scarto della singola dichiarazione o dell'intera fornitura.

### 3.2 Coerenza dei dati della dichiarazione

Nella “*Circolare per la liquidazione ed il controllo del modello 730/2018*” trovano esposizione anche le regole che definiscono l'accoglimento o meno della dichiarazione 730/2018 da trasmettere in via telematica all'Agenzia delle Entrate. In particolare sono riportati, oltre a tutti i criteri per la puntuale determinazione delle imposte, anche i criteri di accoglimento della dichiarazione. Tali criteri, sono suddivisi in confermabili e bloccanti. La dichiarazione 730/2018 predisposta con le modalità previste nelle presenti specifiche tecniche XML, deve essere conforme ai criteri sopra citati. La non conformità della dichiarazione ai suddetti criteri, determina il non accoglimento della stessa in sede di trasmissione telematica.

### 3.3 Il trattamento del Codice Fiscale

I codici fiscali riportati nelle dichiarazioni mod. 730/2018 devono essere formalmente corretti. Si precisa che in sede di accoglimento delle dichiarazioni trasmesse in via telematica, costituirà oggetto di scarto della dichiarazione stessa l'indicazione di un **codice fiscale del contribuente** che, anche se formalmente corretto, non risulti registrato presso l'Anagrafe Tributaria.

Nel caso di omocodia del codice fiscale del contribuente risolta dall'Agenzia delle Entrate con l'attribuzione di un nuovo codice fiscale, l'indicazione in dichiarazione del precedente codice fiscale (omocodice) comporta, in sede di accoglimento delle dichiarazioni trasmesse in via telematica, lo scarto della dichiarazione.

**Il codice fiscale del rappresentante** deve essere registrato in Anagrafe Tributaria; la non registrazione comporta lo scarto della dichiarazione in fase di accettazione **senza possibilità di conferma della stessa.**

**Il codice fiscale del sostituto d'imposta che effettuerà le operazioni di conguaglio** deve essere registrato in Anagrafe Tributaria; la non registrazione comporta lo scarto della dichiarazione in fase di accettazione senza possibilità di conferma della stessa.

**Anche ciascun codice fiscale indicato nel prospetto dei familiari a carico** deve essere registrato in Anagrafe Tributaria; la non registrazione comporta lo scarto della dichiarazione in fase di accettazione senza possibilità di conferma della stessa.

### **3.4 Soggetto che presta l'assistenza fiscale**

L'indicazione del soggetto che ha prestato l'assistenza fiscale con i relativi dati identificativi e l'indicazione della data di consegna del mod. 730/2018 sono obbligatori. Si rimanda alle istruzioni fornite nella circolare di liquidazione al paragrafo "Dati assistenza fiscale da riportare nel flusso telematico".

#### **4 TRASMISSIONE TELEMATICA DEL MOD. 730-4 DA PARTE DEI CAF, DEL PROFESSIONISTA ABILITATO O DI UNA ASSOCIAZIONE PROFESSIONALE ALL'AGENZIA DELLE ENTRATE E DESTINATO AI SOSTITUTI D'IMPOSTA**

Il D.M. n. 164 del 1999, prevede che i soggetti che prestano l'assistenza fiscale trasmettano i risultati finali delle dichiarazioni relative al mod. 730 (mod. 730-4) non più direttamente ai sostituti d'imposta ma all'Agenzia delle Entrate la quale provvederà successivamente ad inviarli telematicamente al sostituto d'imposta.

Pertanto, in sede di trasmissione telematica delle dichiarazioni relative al modello 730/2018, qualora l'assistenza fiscale sia prestata da un CAF, da un professionista abilitato o da una associazione, i dati relativi al suddetto mod. 730-4 dovranno essere allegati ai dati della dichiarazione mod. 730/2018 da trasmettere in via telematica.

In sede di accoglimento delle dichiarazioni trasmesse in via telematica, costituisce oggetto di controllo la coerenza dei dati contenuti nel mod. 730-4 con quelli presenti nel modello 730/2018. Eventuali anomalie riscontrate determinano lo scarto della dichiarazione.

Ai sostituti d'imposta i dati relativi al mod. 730-4 saranno resi disponibili presso la sede telematica comunicata con l'apposito modello di comunicazione trasmesso all'Agenzia delle Entrate

##### **4.1 Trasmissione telematica del mod. 730-4: Casi particolari**

Nel caso in cui dalla liquidazione della dichiarazione (mod. 730 ordinario ovvero mod. 730 integrativo), risulti che non ci sia alcun importo da trattenere o da rimborsare a cura del sostituto d'imposta, i dati relativi al mod. 730-4 non devono essere riportati nel tracciato telematico della dichiarazione 730 2018 e deve essere impostato ad "1" l'apposito campo (**FlagAssenzaDati730-4**) previsto nelle presenti specifiche tecniche del modello 730/2018. La non corretta impostazione della suddetta casella determina lo scarto della dichiarazione 730/2018.

Si precisa che nel caso di un **modello 730 rettificativo**, qualora dalla liquidazione della dichiarazione risulti che non ci sia alcun importo da trattenere o da rimborsare a cura del sostituto d'imposta, i dati relativi al mod. 730-4 devono comunque essere riportati nel tracciato telematico della dichiarazione 730/2018. In tal caso risulteranno pertanto compilati i soli dati relativi al soggetto che ha prestato l'assistenza fiscale, al sostituto d'imposta, al contribuente con l'assenza di tutti i dati contabili.



## **4.2 Dati mod. 730-4 resi disponibili dall’Agenzia delle Entrate ai Sostituti o Intermediari**

I dati relativi al mod. 730-4 saranno resi disponibili da parte dell’Agenzia delle Entrate ai sostituti d’imposta ovvero agli intermediari da questi incaricati in conformità alle istruzioni contenute nelle presenti specifiche tecniche relative al mod. 730/2018 nella sezione riferita alla “**Fornitura 730-4**”. La sintassi della fornitura relativa ai mod. 730-4 è descritta nel file XSD denominato “**fornitura734\_2018\_v1.xsd**” la cui documentazione è allegata al presente documento.

## 5 Specifiche tecniche in formato XML

### 5.1 Generalità Specifiche tecniche in formato XML

#### 5.1.1 Messaggio

Lo schema prevede la definizione di un elemento principale (radice della struttura) denominato **Messaggio**. Esso è un elemento xml di tipo complesso contenente la sequenza ordinata di due sotto-elementi obbligatori **Intestazione** e **Contenuto** dei quali può essere presente una sola occorrenza.

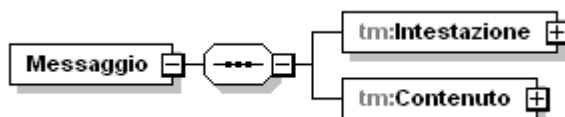

#### 5.1.2 Intestazione

L'elemento xml denominato **Intestazione** è un elemento obbligatorio di tipo complesso **Intestazione\_Type** illustrato nella figura seguente.

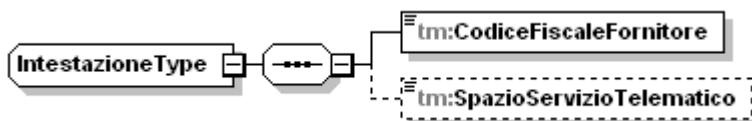

L'elemento **Intestazione** deve contenere i seguenti sottoelementi semplici rispettando la sequenza indicata:

##### CodiceFiscaleFornitore

E' un elemento obbligatorio di tipo semplice che deve esporre il codice fiscale del soggetto responsabile della trasmissione telematica. Il dato è di tipo alfanumerico e può essere composto, in alternativa, o da 11 caratteri numerici (nel caso in cui il codice fiscale si riferisca ad una persona giuridica) oppure da 16 caratteri alfanumerici maiuscoli (nel caso in cui il codice fiscale sia relativo ad una persona fisica).

##### SpazioServizioTelematico

E' un elemento opzionale che deve esporre alcune informazioni riservate al servizio telematico. Tale elemento, pertanto, viene creato esclusivamente da funzionalità predisposte dal servizio telematico. Il dato in esso contenuto è di tipo alfanumerico.

#### 5.1.3 Contenuto

L'elemento xml denominato **Contenuto** deve contenere, al suo interno, i dati identificativi della fornitura ai fini della trasmissione telematica. Pertanto è un elemento di tipo complesso **Contenuto\_Type** illustrato nella figura successiva.

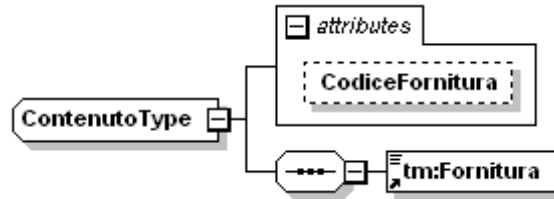

In particolare tale elemento prevede un attributo denominato **CodiceFornitura** ed un sottoelemento **Fornitura**.

L'attributo **CodiceFornitura** identifica il codice della fornitura e serve per individuare in maniera univoca la tipologia di documento contenuto nel file. Tale elemento di tipo semplice è obbligatorio e deve essere composto da 5 caratteri alfanumerici maiuscoli. Per il modello 730/2018 deve assumere il seguente valore “**73018**”.

L'elemento xml denominato **Fornitura**, invece, è un elemento obbligatorio di tipo astratto che deve essere, di volta in volta, implementato dai diversi tipi di fornitura XML.

### **Comunicazione dati rettificati caf o professionisti (Codice Fornitura “73C18”)**

L'art. 6 (visto di conformità) del decreto legislativo 21 novembre 2014, n. 175, ha apportato delle modifiche all'art. 39 del decreto legislativo 9 luglio 1997, n. 241. In particolare, se il Caf o il professionista appone un visto di conformità infedele, è tenuto al pagamento di una somma pari all'importo dell'imposta, della sanzione e degli interessi che sarebbero stati richiesti al contribuente a seguito dei controlli formali da parte dell'Agenzia delle entrate, sempre che il visto infedele non sia stato indotto dalla condotta dolosa del contribuente. Se entro il 10 novembre dell'anno in cui la violazione è stata commessa il Caf o il professionista trasmette una dichiarazione rettificativa del contribuente oppure, se il contribuente non intende presentare la nuova dichiarazione, trasmette una comunicazione dei dati relativi alla rettifica, la somma dovuta dal Caf o dal professionista è pari all'importo della sola sanzione. **La trasmissione delle informazioni relative ai dati rettificati deve avvenire con modalità analoghe a quelle previste per la trasmissione telematica dei dati del modello 730 2018 in conformità alle indicazioni fornite nella Circolare di liquidazione del modello 730 2018 ed impostando l'attributo CodiceFornitura al valore “73C18”.**

#### **5.1.4 Fornitura**

L'elemento denominato **Fornitura** ed è un elemento xml complesso contenente la sequenza ordinata di due sottoelementi: **Intestazione** e **Documento730**, del quale possono essere presenti una o più occorrenze.

#### **5.1.5 Intestazione**

L'elemento Intestazione contiene i dati del soggetto responsabile dell'invio telematico (fornitore):

- TipoFornitore - è l'elemento che definisce la tipologia del soggetto che esegue la trasmissione, è di tipo DatoNP\_Type.

- SpazioUtente - è un elemento opzionale il cui contenuto può essere liberamente definito dall'utente ed è di tipo DatoAN\_Type

### 5.1.6 Documento 730

L'elemento Documento 730 è di tipo Documento\_730\_Type. Il tipo Documento\_730\_Type definisce l'attributo obbligatorio denominato **identificativo**. Tale attributo ha lo scopo di identificare univocamente il generico documento nell'ambito della fornitura ed è di tipo DatoNP\_Type.

Controlli previsti per l'attributo:



Validazione: la lunghezza massima prevista è di 5 caratteri.

Controllo bloccante: il valore assunto dall'attributo deve essere univoco all'interno dell'intera fornitura.

## 5.2 Specifiche tecniche in formato XML

Di seguito viene descritto il contenuto informativo dei dati della fornitura da trasmettere in via telematica (**fornitura730\_2018\_v1.xsd e fornitura734\_2018\_v1.xsd**).

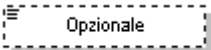
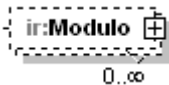
Per la rappresentazione grafica della struttura gerarchica sono utilizzati alcuni simboli grafici descritti nella seguente tabella:

	Elemento obbligatorio
	Elemento opzionale
	Elemento ripetuto 0 o più volte
	Sequenza ordinata di elementi (Sequence)
	Alternativa tra due o più elementi (Choice)

## Schema forniture730\_2018\_v1.xsd

schema location: **forniture730\_2018\_v1.xsd**  
attributeFormDefault: **unqualified**  
elementFormDefault: **qualified**  
targetNamespace: **urn:www.agenziaentrate.gov.it:specificheTecniche:sco:730**

Elements  
[Forniture](#)

schema location: **documento730\_2018\_v1.xsd**  
attributeFormDefault: **unqualified**  
elementFormDefault: **qualified**  
targetNamespace: **urn:www.agenziaentrate.gov.it:specificheTecniche:sco:730**

Elements  
[Documento730](#)

Complex types

- [Acconti Altri Dati Type](#)
- [Acconti Irpef Anno Imposta Type](#)
- [Acconti Ritenute Type](#)
- [Acconti Compensati Intern Type](#)
- [Acquisto Costruzione Abit Type](#)
- [Addizionali Type](#)
- [Altre Detrazioni Type](#)
- [Altre Ritenute Type](#)
- [Altre Spese Type](#)
- [Altri Dati Type](#)
- [Altri Oneri Type](#)
- [Altri Redditi Ass Lav Type](#)
- [Altri Redditi Diversi Detr Type](#)
- [Altri Redditi Diversi Type](#)
- [Altri Redditi Lavoro Autonomo Type](#)
- [Altri Redditi Type](#)
- [Altri Redditi Utili Type](#)
- [Annotazione Type](#)
- [Assegno Coniuge Type](#)
- [Bonus Irpef Type](#)
- [Casella Acconto Type](#)
- [Cedolare Secca Type](#)
- [Comunicazione Amministratore Type](#)
- [Conguaglio Type](#)
- [Contributi Previdenza Complementare Type](#)
- [Contributo Solidarieta Type](#)
- [Cred Erogazione Cultura Type](#)

[Cred Imp Estero Type](#)  
[Crediti F24 Type](#)  
[Crediti Imposta Altri Sisma Abruzzo Type](#)  
[Crediti Imposta Fabbicati Type](#)  
[Crediti Imposta Fondi Pensione Type](#)  
[Crediti Imposta Redditi Esteri Type](#)  
[Crediti Imposta Type](#)  
[Credito Erogazioni Cultura Type](#)  
[Credito Erogazioni Scuola Type](#)  
[Credito Immobile Sisma Abruzzo Type](#)  
[Credito Incremento Occupazione Type](#)  
[Credito Negoziazione Type](#)  
[Credito Stato Type](#)  
[Credito Type](#)  
[Credito Videosorveglianza Type](#)  
[Dati 730 Integrativo Type](#)  
[Dati Altre Detrazioni Modulo Type](#)  
[Dati Altre Detrazioni Type](#)  
[Dati Associazioni Professionale Type](#)  
[Dati CAF Type](#)  
[Dati Catastali Recupero Patrimonio Edilizio Type](#)  
[Dati Catastali Type](#)  
[Dati Condominio Type](#)  
[Dati Coniuge Type](#)  
[Dati Contabili Type](#)  
[Dati Contratto Type](#)  
[Dati Familiare Type](#)  
[Dati Fornitore Type](#)  
[Dati Nascita PF Type](#)  
[Dati Primo Figlio Type](#)  
[Dati Professionista Type](#)  
[Dati Registrazione Accatastamento Recupero Patrimonio Edilizio Type](#)  
[Dati Rettificati Type](#)  
[Debito Type](#)  
[Deduzioni Modulo Type](#)  
[Deduzioni Type](#)  
[Detrazione Crediti Type](#)  
[Detrazioni Canoni Locazione Type](#)  
[Detrazioni Modulo Type](#)  
[Detrazioni Type](#)  
[Dichiarazione Con Type](#)  
[Dichiarazione Dich Type](#)  
[Documento 730-4](#)  
[Documento 730 Type](#)  
[Domanda Accatastamento Type](#)

[Domicilio Fiscale Type](#)  
[Domicilio Sogg Ass Fiscale Type](#)  
[Eccedenze Oltre Anno Type](#)  
[Eccedenze Type](#)  
[Elemento Integrativo Type](#)  
[Esenzione Add Comunale Type](#)  
[Esenzione Bonus Type](#)  
[Esito Liquidazione Type](#)  
[Fabbricato Agev Type](#)  
[Fabbricato Ord Type](#)  
[Familiari Type](#)  
[Firma Dichiarazione Type](#)  
[Fondo Pensione Dipendenti Pubblici Type](#)  
[Frontespizio 730 Type](#)  
[Frontespizio Con Type](#)  
[Frontespizio Dich Type](#)  
[Fuori Assistenza Type](#)  
[Giorni Percentuale Type](#)  
[Importi Rimborsare 730-4 Integrativo Type](#)  
[Importi Rimborsare 730-4 Type](#)  
[Importi Trattenere 730-4 Type](#)  
[Importo 730-4](#)  
[Imposta Lorda Type](#)  
[Imposta Netta Type](#)  
[Imposte Rimborsate Type](#)  
[Inquilini Abitazione Principale Type](#)  
[Intervento Recupero Patrimonio Edilizio Type](#)  
[Intervento Risparmio Energetico Type](#)  
[Iva Acquisto Abitazione Type](#)  
[Lavoro Dipendente Type](#)  
[Locazioni Brevi Type](#)  
[Misura Acconti Type](#)  
[Mod730 Integrativo Type](#)  
[Modulo Altri Redditi Type](#)  
[Modulo Annotazioni Type](#)  
[Modulo Comunicazione Type](#)  
[Modulo Crediti Imposta Type](#)  
[Modulo Credito Negoziazione Type](#)  
[Modulo Fabbricato Type](#)  
[Modulo Familiari Type](#)  
[Modulo Lavoro Dip Type](#)  
[Modulo Oneri Type](#)  
[Modulo PL Type](#)  
[Modulo Terreno Type](#)  
[Oneri Non Abbattuti Type](#)

[Oneri Type](#)  
[Opzione Produttivita Type](#)  
[Periodo Di Lavoro Type](#)  
[Pignoramento Type](#)  
[Premi Risultato Modulo Type](#)  
[Premi Risultato Type](#)  
[Primo Modulo Acconti Ritenute Type](#)  
[Primo Modulo Crediti Imposta Type](#)  
[Primo Modulo Familiari Type](#)  
[Primo Modulo Lavoro Dip Type](#)  
[Primo Modulo Oneri Type](#)  
[Primo Modulo PL Type](#)  
[Prospetto Annotazioni Type](#)  
[Prospetto Liquidazione Type](#)  
[Prospetto Type](#)  
[Quadro I Type](#)  
[Quadro K Type](#)  
[Rappresentante Type](#)  
[Redditi Capitale Type](#)  
[Redditi Eredi Legatari Type](#)  
[Redditi Fabbricati Type](#)  
[Redditi Lavoro Dip Type](#)  
[Redditi Ritenute Spese Type](#)  
[Redditi Ritenute Type](#)  
[Redditi Tassazione Separata Type](#)  
[Redditi Terreni Type](#)  
[Reddito Erede Type](#)  
[Residenza Anagrafica 730 Type](#)  
[Residenza Rappresentante Type](#)  
[Residenza Type](#)  
[Residuo Credito Compens AnnoImposta Type](#)  
[Residuo Credito Compens Type](#)  
[Residuo Fabbricati Type](#)  
[Restituzione Somme Type](#)  
[Rettifica Type](#)  
[Riepilogo Redditi Type](#)  
[Ritenute Acconti Sospesi Type](#)  
[Ritenute Lavoro Dip Type](#)  
[Sezione Altri Redd Type](#)  
[Sezione Dati Catastali Recupero Patrimonio Edilizio Type](#)  
[Soggetto Assistenza Fiscale Doc Type](#)  
[Soggetto Fiscale 730 Type](#)  
[Soglie Esenzione Type](#)  
[Sostituto Type](#)  
[Spese Arredo Giovani Coppie Type](#)



[Spese Arredo Type](#)  
[Spese Leasing Type](#)  
[Spese Rateizzate Anni Precedenti Type](#)  
[Spese Rateizzate Type](#)  
[Tassazione Separata Type](#)  
[Terreno Type](#)  
[Versamenti F24 Type](#)

schema location: **intestazione730\_2018\_v1.xsd**  
attributeFormDefault: **unqualified**  
elementFormDefault: **qualified**  
targetNamespace: **urn:www.agenziaentrate.gov.it:specificheTecniche:sco:730**

Elements      Complex types  
[Intestazione](#)      [Intestazione 730 Type](#)

schema location: **types730\_2018\_v1.xsd**  
attributeFormDefault: **unqualified**  
elementFormDefault: **qualified**  
targetNamespace: **urn:www.agenziaentrate.gov.it:specificheTecniche:sco:730**

Simple types

[Anno Anticipazione Fondo Pensione Type](#)  
[Anno Recupero Patrimonio Edilizio Type](#)  
[Anno Risparmio Energetico Type](#)  
[Casi Particolari Fabbricato Type](#)  
[Casi Particolari Risp Ener Type](#)  
[Casi Particolari Terreni Type](#)  
[Codice Altre Detrazioni Type](#)  
[Codice Altre Spese Type](#)  
[Codice Altri Oneri Type](#)  
[Codice Canone Type](#)  
[Codice Evento Eccezionale Type](#)  
[Codice Spese Rateizzate Anni Precedenti Type](#)  
[Codice Spese Rateizzate Type](#)  
[Fabbricato Agev Numero Rigo Type](#)  
[Indeterminato Determinato Type](#)  
[Integrativo Type](#)  
[Mesi Type](#)  
[Numero Rata Risparmio Energetico Type](#)  
[Periodo Spese Ristrutturazione Type](#)  
[Rate10 Type](#)  
[Rate Risparmio Energetico Type](#)  
[Reintegro Totale Parziale Type](#)  
[Rettificativo Type](#)  
[Serie Registrazione Contratto Type](#)  
[Stato Civile Type](#)  
[Terreni Urbano Type](#)  
[Tipo Inquilino Type](#)  
[Tipo Intervento Type](#)  
[Tipo Reddito Da1a4 Type](#)  
[Tipo Reddito Da1a8 Type](#)  
[Tipologia Soggetto Ass Fisc Type](#)

[Titolo Terreno Type](#)  
[Utilizzo Fabbricato Type](#)

schema location: **datiSce\_2018\_v1.xsd**  
 attributeFormDefault: **unqualified**  
 elementFormDefault: **qualified**  
 targetNamespace: **urn:www.agenziaentrate.gov.it:specificheTecniche:sco:sce**

Complex types  
[Scelta2PerMille Type](#)  
[Scelta2PerMilleAssCult Type](#)  
[Scelta5PerMille Type](#)  
[Scelta8PerMille Type](#)  
[Scelte Type](#)

**element Fornitura**

diagram	
namespace	urn:www.agenziaentrate.gov.it:specificheTecniche:sco:730
substitution group	<a href="#">tm:Fornitura</a>
children	<a href="#">m730:Intestazione</a> <a href="#">m730:Documento730</a>

element **Documento730**

diagram					
namespace	urn:www.agenziaentrate.gov.it:specificheTecniche:sco:730				
type	<a href="#">m730:Documento_730_Type</a>				
children	<a href="#">m730:DichiarazioneDich</a> <a href="#">m730:DichiarazioneCon</a> <a href="#">m730:AltriDati</a> <a href="#">m730:Sostituto</a> <a href="#">m730:Mod730DipendentiSenzaSostituto</a> <a href="#">m730:SoggettoAssFiscaleDoc</a> <a href="#">m730:Documento_730-4</a> <a href="#">m730:EsitiContabili</a> <a href="#">m730:DatiRettificati</a>				
attributes	Name	Type	Use	Default	Fixed
	<a href="#">identificativo</a>	<a href="#">Identificativo_Type</a>	required		

complexType **Acconti\_Altri\_Dati\_Type**

diagram					
namespace	urn:www.agenziaentrate.gov.it:specificheTecniche:sco:730				

children	<a href="#">m730:IncapientiDetrazioneFigli</a> <a href="#">m730:IncapientiDetrazioneLocazione</a> <a href="#">m730:RestituzioneBonusFiscale</a> <a href="#">m730:RestituzioneBonusStraordinario</a> <a href="#">m730:Pignoramento</a>
----------	--

#### element **Acconti\_Altri\_Dati\_Type/IncapientiDetrazioneFigli**

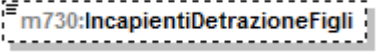
diagram	
namespace	urn:www.agenziaentrate.gov.it:specificheTecniche:sco:730
type	<a href="#">DatoNP_Type</a>
facets	Kind Value pattern [1-9]{1}[0-9]*

#### element **Acconti\_Altri\_Dati\_Type/IncapientiDetrazioneLocazione**

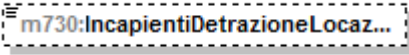
diagram	
namespace	urn:www.agenziaentrate.gov.it:specificheTecniche:sco:730
type	<a href="#">DatoNP_Type</a>
facets	Kind Value pattern [1-9]{1}[0-9]*

#### element **Acconti\_Altri\_Dati\_Type/RestituzioneBonusFiscale**

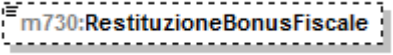
diagram	
namespace	urn:www.agenziaentrate.gov.it:specificheTecniche:sco:730
type	<a href="#">DatoNP_Type</a>
facets	Kind Value pattern [1-9]{1}[0-9]*

#### element **Acconti\_Altri\_Dati\_Type/RestituzioneBonusStraordinario**

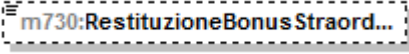
diagram	
namespace	urn:www.agenziaentrate.gov.it:specificheTecniche:sco:730
type	<a href="#">DatoNP_Type</a>
facets	Kind Value pattern [1-9]{1}[0-9]*

element **Acconti\_Altri\_Dati\_Type/Pignoramento**

diagram	
namespace	urn:www.agenziaentrate.gov.it:specificheTecniche:sco:730
type	<a href="#">m730:Pignoramento_Type</a>
children	<a href="#">m730:TipoRedditoPignoramento</a> <a href="#">m730:RitenutePignoramento</a>

complexType **Acconti\_Irpef\_Anno\_Imposta\_Type**

diagram	
namespace	urn:www.agenziaentrate.gov.it:specificheTecniche:sco:730
children	<a href="#">m730:PrimaRataAccontolrpef</a> <a href="#">m730:SecondaRataAccontolrpef</a> <a href="#">m730:AccontoAddComunale</a> <a href="#">m730:PrimaRataAccontoCedolare</a> <a href="#">m730:SecondaRataAccontoCedolare</a>

element **Acconti\_Irpef\_Anno\_Imposta\_Type/PrimaRataAccontolrpef**

diagram					
namespace	urn:www.agenziaentrate.gov.it:specificheTecniche:sco:730				
type	<a href="#">DatoNP_Type</a>				
facets	<table border="1"> <tr> <td>Kind</td> <td>Value</td> </tr> <tr> <td>pattern</td> <td>[1-9]{1}[0-9]*</td> </tr> </table>	Kind	Value	pattern	[1-9]{1}[0-9]*
Kind	Value				
pattern	[1-9]{1}[0-9]*				

element **Acconti\_Irpef\_Anno\_Imposta\_Type/SecondaRataAccontolrpef**

diagram					
namespace	urn:www.agenziaentrate.gov.it:specificheTecniche:sco:730				
type	<a href="#">DatoNP_Type</a>				
facets	<table border="1"> <tr> <td>Kind</td> <td>Value</td> </tr> <tr> <td>pattern</td> <td>[1-9]{1}[0-9]*</td> </tr> </table>	Kind	Value	pattern	[1-9]{1}[0-9]*
Kind	Value				
pattern	[1-9]{1}[0-9]*				

element **Acconti\_Irpef\_Anno\_Imposta\_Type/AccontoAddComunale**

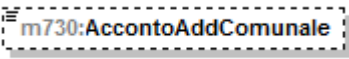
diagram	
namespace	urn:www.agenziaentrate.gov.it:specificheTecniche:sco:730
type	<a href="#">DatoNP_Type</a>
facets	Kind Value pattern [1-9]{1}[0-9]*

element **Acconti\_Irpef\_Anno\_Imposta\_Type/PrimaRataAccontoCedolare**

diagram	
namespace	urn:www.agenziaentrate.gov.it:specificheTecniche:sco:730
type	<a href="#">DatoNP_Type</a>
facets	Kind Value pattern [1-9]{1}[0-9]*

element **Acconti\_Irpef\_Anno\_Imposta\_Type/SecondaRataAccontoCedolare**

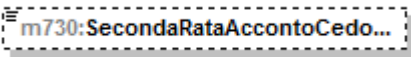
diagram	
namespace	urn:www.agenziaentrate.gov.it:specificheTecniche:sco:730
type	<a href="#">DatoNP_Type</a>
facets	Kind Value pattern [1-9]{1}[0-9]*

complexType **Acconti\_Ritenute\_Type**

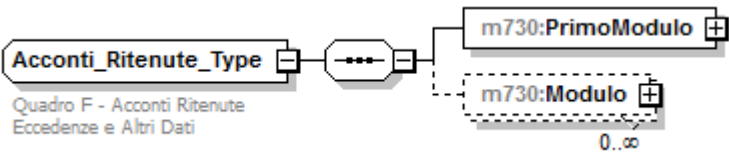
diagram	
namespace	urn:www.agenziaentrate.gov.it:specificheTecniche:sco:730
children	<a href="#">m730:PrimoModulo</a> <a href="#">m730:Modulo</a>

element **Acconti\_Ritenute\_Type/PrimoModulo**

<p>diagram</p>	
<p>namespace</p>	<p>urn:www.agenziaentrate.gov.it:specificheTecniche:sco:730</p>
<p>type</p>	<p><a href="#">m730:Primo_Modulo_Acconti_Ritenute_Type</a></p>
<p>children</p>	<p><a href="#">m730:Accontilrpef</a> <a href="#">m730:AltreRitenute</a> <a href="#">m730:Eccedenze</a> <a href="#">m730:EccedenzeOltreAnno</a> <a href="#">m730:RitenuteAccontiSospesi</a> <a href="#">m730:MisuraAcconti</a> <a href="#">m730:EsenzioneAddComunale</a> <a href="#">m730:Dati730Integrativo</a> <a href="#">m730:AccontiAltriDati</a> <a href="#">m730:LocazioniBrevi</a></p>

element **Acconti\_Ritenute\_Type/Modulo**

<p>diagram</p>	
<p>namespace</p>	<p>urn:www.agenziaentrate.gov.it:specificheTecniche:sco:730</p>
<p>children</p>	<p><a href="#">m730:AltreRitenute</a> <a href="#">m730:EccedenzeOltreAnno</a> <a href="#">m730:Pignoramento</a></p>

element **Acconti\_Ritenute\_Type/Modulo/AltreRitenute**

<p>diagram</p>	
<p>namespace</p>	<p>urn:www.agenziaentrate.gov.it:specificheTecniche:sco:730</p>
<p>type</p>	<p><a href="#">m730:Altre Ritenute Type</a></p>
<p>children</p>	<p><a href="#">m730:Codice</a> <a href="#">m730:AltreRitenuteIrpef</a> <a href="#">m730:AddizionaleRegionale</a> <a href="#">m730:AddizionaleComunale</a> <a href="#">m730:AddRegionaleIrpefAttivitaSport</a> <a href="#">m730:AddComunaleIrpefAttivitaSport</a> <a href="#">m730:IrpefLavoriSocialmenteUtili</a> <a href="#">m730:AddRegionaleIrpefLavoriSoc Utili</a></p>

element **Acconti\_Ritenute\_Type/Modulo/EccedenzeOltreAnno**

<p>diagram</p>	
----------------	--



namespace	urn:www.agenziaentrate.gov.it:specificheTecniche:sco:730
type	<a href="#">m730:Eccedenze Oltre Anno Type</a>
children	<a href="#">m730:Anno</a> <a href="#">m730:lrpef</a> <a href="#">m730:SostitutivaQuadroRT</a> <a href="#">m730:CedolareSecca</a> <a href="#">m730:CodiceRegione</a> <a href="#">m730:AddRegionalelrpef</a> <a href="#">m730:CodiceCatastaleComune</a> <a href="#">m730:AddComunalelrpef</a> <a href="#">m730:ImpostaSostitutiva</a>

element **Acconti\_Ritenute\_Type/Modulo/Pignoramento**

diagram	
namespace	urn:www.agenziaentrate.gov.it:specificheTecniche:sco:730
type	<a href="#">m730:Pignoramento Type</a>
children	<a href="#">m730:TipoRedditoPignoramento</a> <a href="#">m730:RitenutePignoramento</a>

complexType **Acconti\_Compensati\_Intern\_Type**

diagram	
namespace	urn:www.agenziaentrate.gov.it:specificheTecniche:sco:730
children	<a href="#">m730:PrimaRatalrpef</a> <a href="#">m730:AddizionaleComunale</a> <a href="#">m730:PrimaRataCedolare</a>

element **Acconti\_Compensati\_Intern\_Type/PrimaRatalrpef**

diagram					
namespace	urn:www.agenziaentrate.gov.it:specificheTecniche:sco:730				
type	<a href="#">DatoNP_Type</a>				
facets	<table border="1"> <tr> <td>Kind</td> <td>Value</td> </tr> <tr> <td>pattern</td> <td>[1-9]{1}[0-9]*</td> </tr> </table>	Kind	Value	pattern	[1-9]{1}[0-9]*
Kind	Value				
pattern	[1-9]{1}[0-9]*				

element **Acconti\_Compensati\_Intern\_Type/AddizionaleComunale**

diagram	
namespace	urn:www.agenziaentrate.gov.it:specificheTecniche:sco:730

type	<a href="#">DatoNP_Type</a>
facets	Kind Value pattern [1-9]{1}[0-9]*

#### element **Acoonti\_Compensati\_Intern\_Type/PrimaRataCedolare**

diagram	
namespace	urn:www.agenziaentrate.gov.it:specificheTecniche:sco:730
type	<a href="#">DatoNP_Type</a>
facets	Kind Value pattern [1-9]{1}[0-9]*

#### complexType **Acquisto\_Costruzione\_Abit\_Type**

diagram	
namespace	urn:www.agenziaentrate.gov.it:specificheTecniche:sco:730
children	<a href="#">m730:DataStipula</a> <a href="#">m730:Spesa</a> <a href="#">m730:InteressiMutuo</a>

#### element **Acquisto\_Costruzione\_Abit\_Type/DataStipula**

diagram	
namespace	urn:www.agenziaentrate.gov.it:specificheTecniche:sco:730
type	<a href="#">DatoDT_Type</a>
facets	Kind Value pattern (((0[1-9][12][0-9]3[01])(0[13578]1012)\d{4})) (((0[1-9][12][0-9]30)(0[469]11)\d{4})) ((0[1-9]1[0-9]2[0-8])(02)\d{4})) ((29)(02)([02468][048]00)) ((29)(02)([13579][26]00)) ((29)(02)([0-9][0][48])) ((29)(02)([0-9][0-9][2468][048])) ((29)(02)([0-9][0-9][13579][26]))

#### element **Acquisto\_Costruzione\_Abit\_Type/Spesa**

diagram	
namespace	urn:www.agenziaentrate.gov.it:specificheTecniche:sco:730
type	<a href="#">DatoNP_Type</a>
facets	Kind Value pattern [1-9]{1}[0-9]*

element **Acquisto\_Costruzione\_Abit\_Type/InteressiMutuo**

diagram	
namespace	urn:www.agenziaentrate.gov.it:specificheTecniche:sco:730
type	<a href="#">DatoNP_Type</a>
facets	Kind Value pattern [1-9]{1}[0-9]*

complexType **Addizionali\_Type**

diagram	
namespace	urn:www.agenziaentrate.gov.it:specificheTecniche:sco:730
children	<a href="#">m730:Imponibile</a> <a href="#">m730:AddRegDovuta</a> <a href="#">m730:AddRegCertif</a> <a href="#">m730:EccedenzaAddReg</a> <a href="#">m730:AddComDovuta</a> <a href="#">m730:AddComCertif</a> <a href="#">m730:EccedenzaAddCom</a> <a href="#">m730:AccontoAddCom</a> <a href="#">m730:AccontoAddComCertif</a>

element **Addizionali\_Type/Imponibile**

diagram	
namespace	urn:www.agenziaentrate.gov.it:specificheTecniche:sco:730
type	<a href="#">DatoNP_Type</a>
facets	Kind Value pattern [1-9]{1}[0-9]*

element **Addizionali\_Type/AddRegDovuta**

diagram	
---------	--

namespace	urn:www.agenziaentrate.gov.it:specificheTecniche:sco:730
type	<a href="#">DatoNP_Type</a>
facets	Kind Value pattern [1-9]{1}[0-9]*

#### element **Addizionali\_Type/AddRegCertif**

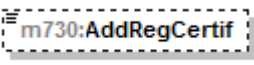
diagram	
namespace	urn:www.agenziaentrate.gov.it:specificheTecniche:sco:730
type	<a href="#">DatoNP_Type</a>
facets	Kind Value pattern [1-9]{1}[0-9]*

#### element **Addizionali\_Type/EccedenzaAddReg**

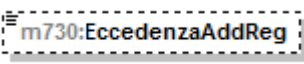
diagram	
namespace	urn:www.agenziaentrate.gov.it:specificheTecniche:sco:730
type	<a href="#">DatoNU_Type</a>
facets	Kind Value pattern (\-[1-9] [1-9])[0-9]*

#### element **Addizionali\_Type/AddComDovuta**

diagram	
namespace	urn:www.agenziaentrate.gov.it:specificheTecniche:sco:730
type	<a href="#">DatoNP_Type</a>
facets	Kind Value pattern [1-9]{1}[0-9]*

#### element **Addizionali\_Type/AddComCertif**

diagram	
namespace	urn:www.agenziaentrate.gov.it:specificheTecniche:sco:730
type	<a href="#">DatoNP_Type</a>
facets	Kind Value pattern [1-9]{1}[0-9]*

element **Additionali\_Type/EccedenzaAddCom**

diagram					
namespace	urn:www.agenziaentrate.gov.it:specificheTecniche:sco:730				
type	<a href="#">DatoNU_Type</a>				
facets	<table border="1"> <tr> <td>Kind</td> <td>Value</td> </tr> <tr> <td>pattern</td> <td>(\-[1-9]) [1-9])[0-9]*</td> </tr> </table>	Kind	Value	pattern	(\-[1-9]) [1-9])[0-9]*
Kind	Value				
pattern	(\-[1-9]) [1-9])[0-9]*				

element **Additionali\_Type/AccontoAddCom**

diagram					
namespace	urn:www.agenziaentrate.gov.it:specificheTecniche:sco:730				
type	<a href="#">DatoNP_Type</a>				
facets	<table border="1"> <tr> <td>Kind</td> <td>Value</td> </tr> <tr> <td>pattern</td> <td>[1-9]{1}[0-9]*</td> </tr> </table>	Kind	Value	pattern	[1-9]{1}[0-9]*
Kind	Value				
pattern	[1-9]{1}[0-9]*				

element **Additionali\_Type/AccontoAddComCertif**

diagram					
namespace	urn:www.agenziaentrate.gov.it:specificheTecniche:sco:730				
type	<a href="#">DatoNP_Type</a>				
facets	<table border="1"> <tr> <td>Kind</td> <td>Value</td> </tr> <tr> <td>pattern</td> <td>[1-9]{1}[0-9]*</td> </tr> </table>	Kind	Value	pattern	[1-9]{1}[0-9]*
Kind	Value				
pattern	[1-9]{1}[0-9]*				

complexType **Altre\_Detrazioni\_Type**

diagram	
namespace	urn:www.agenziaentrate.gov.it:specificheTecniche:sco:730
children	<a href="#">m730:Codice</a> <a href="#">m730:Importo</a>

element **Altre\_Detrazioni\_Type/Codice**

diagram							
namespace	urn:www.agenziaentrate.gov.it:specificheTecniche:sco:730						
type	<a href="#">m730:Codice</a> <a href="#">Altre_Detrazioni_Type</a>						
facets	<table border="1"> <tr> <td>Kind</td> <td>Value</td> </tr> <tr> <td>pattern</td> <td>[1-9]{1}[0-9]*</td> </tr> <tr> <td>enumeration</td> <td>1</td> </tr> </table>	Kind	Value	pattern	[1-9]{1}[0-9]*	enumeration	1
Kind	Value						
pattern	[1-9]{1}[0-9]*						
enumeration	1						

	enumeration 2
--	---------------

### element **Altre\_Detrazioni\_Type/Importo**

diagram					
namespace	urn:www.agenziaentrate.gov.it:specificheTecniche:sco:730				
type	<a href="#">DatoNP_Type</a>				
facets	<table border="1"> <tr> <td>Kind</td> <td>Value</td> </tr> <tr> <td>pattern</td> <td>[1-9]{1}[0-9]*</td> </tr> </table>	Kind	Value	pattern	[1-9]{1}[0-9]*
Kind	Value				
pattern	[1-9]{1}[0-9]*				

### complexType **Altre\_Ritenute\_Type**

diagram	
namespace	urn:www.agenziaentrate.gov.it:specificheTecniche:sco:730
children	<a href="#">m730:Codice</a> <a href="#">m730:AltreRitenuteIrpef</a> <a href="#">m730:AddizionaleRegionale</a> <a href="#">m730:AddizionaleComunale</a> <a href="#">m730:AddRegionaleIrpefAttivitaSport</a> <a href="#">m730:AddComunaleIrpefAttivitaSport</a> <a href="#">m730:IrpefLavoriSocialmenteUtili</a> <a href="#">m730:AddRegionaleIrpefLavoriSoc</a> <a href="#">Utili</a>

### element **Altre\_Ritenute\_Type/Codice**

diagram									
namespace	urn:www.agenziaentrate.gov.it:specificheTecniche:sco:730								
type	restriction of <a href="#">DatoN1_Type</a>								
facets	<table border="1"> <tr> <td>Kind</td> <td>Value</td> </tr> <tr> <td>pattern</td> <td>[1-9]</td> </tr> <tr> <td>enumeration</td> <td>1</td> </tr> <tr> <td>enumeration</td> <td>2</td> </tr> </table>	Kind	Value	pattern	[1-9]	enumeration	1	enumeration	2
Kind	Value								
pattern	[1-9]								
enumeration	1								
enumeration	2								

element **Altre\_Ritenute\_Type/AltreRitenuteIrpef**

diagram	
namespace	urn:www.agenziaentrate.gov.it:specificheTecniche:sco:730
type	<a href="#">DatoNP_Type</a>
facets	Kind Value pattern [1-9]{1}[0-9]*

element **Altre\_Ritenute\_Type/AddizionaleRegionale**

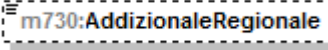
diagram	
namespace	urn:www.agenziaentrate.gov.it:specificheTecniche:sco:730
type	<a href="#">DatoNP_Type</a>
facets	Kind Value pattern [1-9]{1}[0-9]*

element **Altre\_Ritenute\_Type/AddizionaleComunale**

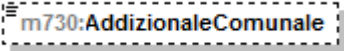
diagram	
namespace	urn:www.agenziaentrate.gov.it:specificheTecniche:sco:730
type	<a href="#">DatoNP_Type</a>
facets	Kind Value pattern [1-9]{1}[0-9]*

element **Altre\_Ritenute\_Type/AddRegionaleIrpefAttivitaSport**

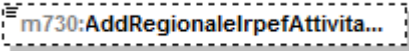
diagram	
namespace	urn:www.agenziaentrate.gov.it:specificheTecniche:sco:730
type	<a href="#">DatoNP_Type</a>
facets	Kind Value pattern [1-9]{1}[0-9]*

element **Altre\_Ritenute\_Type/AddComunaleIrpefAttivitaSport**

diagram	
namespace	urn:www.agenziaentrate.gov.it:specificheTecniche:sco:730
type	<a href="#">DatoNP_Type</a>
facets	Kind Value pattern [1-9]{1}[0-9]*

element **Altre\_Ritenute\_Type/IrpefLavoriSocialmenteUtili**

diagram					
namespace	urn:www.agenziaentrate.gov.it:specificheTecniche:sco:730				
type	<a href="#">DatoNP_Type</a>				
facets	<table border="1"> <thead> <tr> <th>Kind</th> <th>Value</th> </tr> </thead> <tbody> <tr> <td>pattern</td> <td>[1-9]{1}[0-9]*</td> </tr> </tbody> </table>	Kind	Value	pattern	[1-9]{1}[0-9]*
Kind	Value				
pattern	[1-9]{1}[0-9]*				

element **Altre\_Ritenute\_Type/AddRegionaleIrpefLavoriSoc\_Utili**

diagram					
namespace	urn:www.agenziaentrate.gov.it:specificheTecniche:sco:730				
type	<a href="#">DatoNP_Type</a>				
facets	<table border="1"> <thead> <tr> <th>Kind</th> <th>Value</th> </tr> </thead> <tbody> <tr> <td>pattern</td> <td>[1-9]{1}[0-9]*</td> </tr> </tbody> </table>	Kind	Value	pattern	[1-9]{1}[0-9]*
Kind	Value				
pattern	[1-9]{1}[0-9]*				

complexType **Altre\_Spese\_Type**

diagram	
namespace	urn:www.agenziaentrate.gov.it:specificheTecniche:sco:730
children	<a href="#">m730:Codice</a> <a href="#">m730:Importo</a>

element **Altre\_Spese\_Type/Codice**

diagram																																	
namespace	urn:www.agenziaentrate.gov.it:specificheTecniche:sco:730																																
type	restriction of <a href="#">m730:Codice</a> <a href="#">Altre_Spese_Type</a>																																
facets	<table border="1"> <thead> <tr> <th>Kind</th> <th>Value</th> </tr> </thead> <tbody> <tr> <td>pattern</td> <td>[1-9]{1}[0-9]*</td> </tr> <tr> <td>enumeration</td> <td>8</td> </tr> <tr> <td>enumeration</td> <td>9</td> </tr> <tr> <td>enumeration</td> <td>10</td> </tr> <tr> <td>enumeration</td> <td>11</td> </tr> <tr> <td>enumeration</td> <td>12</td> </tr> <tr> <td>enumeration</td> <td>13</td> </tr> <tr> <td>enumeration</td> <td>14</td> </tr> <tr> <td>enumeration</td> <td>15</td> </tr> <tr> <td>enumeration</td> <td>16</td> </tr> <tr> <td>enumeration</td> <td>17</td> </tr> <tr> <td>enumeration</td> <td>18</td> </tr> <tr> <td>enumeration</td> <td>20</td> </tr> <tr> <td>enumeration</td> <td>21</td> </tr> <tr> <td>enumeration</td> <td>22</td> </tr> </tbody> </table>	Kind	Value	pattern	[1-9]{1}[0-9]*	enumeration	8	enumeration	9	enumeration	10	enumeration	11	enumeration	12	enumeration	13	enumeration	14	enumeration	15	enumeration	16	enumeration	17	enumeration	18	enumeration	20	enumeration	21	enumeration	22
Kind	Value																																
pattern	[1-9]{1}[0-9]*																																
enumeration	8																																
enumeration	9																																
enumeration	10																																
enumeration	11																																
enumeration	12																																
enumeration	13																																
enumeration	14																																
enumeration	15																																
enumeration	16																																
enumeration	17																																
enumeration	18																																
enumeration	20																																
enumeration	21																																
enumeration	22																																



enumeration	23
enumeration	24
enumeration	25
enumeration	26
enumeration	27
enumeration	28
enumeration	29
enumeration	30
enumeration	31
enumeration	32
enumeration	33
enumeration	35
enumeration	36
enumeration	38
enumeration	39
enumeration	41
enumeration	42
enumeration	99

**element Altre\_Spese\_Type/Importo**

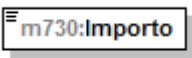
diagram					
namespace	urn:www.agenziaentrate.gov.it:specificheTecniche:sco:730				
type	<a href="#">DatoNP_Type</a>				
facets	<table border="1"> <tr> <td>Kind</td> <td>Value</td> </tr> <tr> <td>pattern</td> <td>[1-9]{1}[0-9]*</td> </tr> </table>	Kind	Value	pattern	[1-9]{1}[0-9]*
Kind	Value				
pattern	[1-9]{1}[0-9]*				

complexType Altri\_Dati\_Type

<p>diagram</p>	
<p>namespace</p>	<p>urn:www.agenziaentrate.gov.it:specificheTecniche:sco:730</p>
<p>children</p>	<p><a href="#">m730:ResiduoCreditoErogazioneCultura</a> <a href="#">m730:ResiduoCreditoPrimaCasa</a> <a href="#">m730:ResiduoCreditoOccupazione</a> <a href="#">m730:ResiduoCreditoSisma</a> <a href="#">m730:ResiduoCreditoFondiPensione</a> <a href="#">m730:ResiduoCreditoMediazioni</a> <a href="#">m730:TotSpeseSanitarieRateizzate</a> <a href="#">m730:RedditoAgevolazioniFiscali</a> <a href="#">m730:RedditoComplessivoAcconto</a> <a href="#">m730:RigoDifferenzaAcconto</a> <a href="#">m730:AccontiCompensatiIntern</a> <a href="#">m730:RedditiFondariNonImponibili</a> <a href="#">m730:RedditoAbitazionePrincipalePertinenze</a> <a href="#">m730:ResiduoDeduzioneSommeRestituite</a> <a href="#">m730:ResiduoErogazioniScuola</a> <a href="#">m730:ResiduoCreditoNegoziazione</a> <a href="#">m730:ResiduoCreditoVideosorveglianza</a> <a href="#">m730:CreditoErogazioneCultura</a></p>

element Altri\_Dati\_Type/ResiduoCreditoErogazioneCultura

<p>diagram</p>	
----------------	--

namespace	urn:www.agenziaentrate.gov.it:specificheTecniche:sco:730
type	<a href="#">DatoNP_Type</a>
facets	Kind Value pattern [1-9]{1}[0-9]*

#### element Altri\_Dati\_Type/ResiduoCreditoPrimaCasa

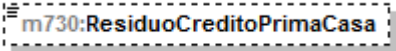
diagram	
namespace	urn:www.agenziaentrate.gov.it:specificheTecniche:sco:730
type	<a href="#">DatoNP_Type</a>
facets	Kind Value pattern [1-9]{1}[0-9]*

#### element Altri\_Dati\_Type/ResiduoCreditoOccupazione

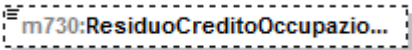
diagram	
namespace	urn:www.agenziaentrate.gov.it:specificheTecniche:sco:730
type	<a href="#">DatoNP_Type</a>
facets	Kind Value pattern [1-9]{1}[0-9]*

#### element Altri\_Dati\_Type/ResiduoCreditoSisma

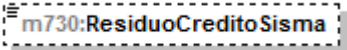
diagram	
namespace	urn:www.agenziaentrate.gov.it:specificheTecniche:sco:730
type	<a href="#">DatoNP_Type</a>
facets	Kind Value pattern [1-9]{1}[0-9]*

#### element Altri\_Dati\_Type/ResiduoCreditoFondiPensione

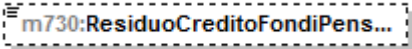
diagram	
namespace	urn:www.agenziaentrate.gov.it:specificheTecniche:sco:730
type	<a href="#">DatoNP_Type</a>
facets	Kind Value pattern [1-9]{1}[0-9]*

element **Altri\_Dati\_Type/ResiduoCreditoMediazioni**

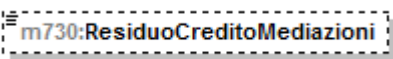
diagram	
namespace	urn:www.agenziaentrate.gov.it:specificheTecniche:sco:730
type	<a href="#">DatoNP_Type</a>
facets	Kind Value pattern [1-9]{1}[0-9]*

element **Altri\_Dati\_Type/TotSpeseSanitarieRateizzate**

diagram	
namespace	urn:www.agenziaentrate.gov.it:specificheTecniche:sco:730
type	<a href="#">DatoNP_Type</a>
facets	Kind Value pattern [1-9]{1}[0-9]*

element **Altri\_Dati\_Type/RedditoAgevolazioniFiscali**

diagram	
namespace	urn:www.agenziaentrate.gov.it:specificheTecniche:sco:730
type	<a href="#">DatoNP_Type</a>
facets	Kind Value pattern [1-9]{1}[0-9]*

element **Altri\_Dati\_Type/RedditoComplessivoAcconto**

diagram	
namespace	urn:www.agenziaentrate.gov.it:specificheTecniche:sco:730
type	<a href="#">DatoNP_Type</a>
facets	Kind Value pattern [1-9]{1}[0-9]*

element **Altri\_Dati\_Type/RigoDifferenzaAcconto**

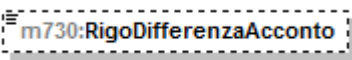
diagram	
namespace	urn:www.agenziaentrate.gov.it:specificheTecniche:sco:730
type	<a href="#">DatoNU_Type</a>
facets	Kind Value pattern (\-[1-9] [1-9])[0-9]*

element **Altri\_Dati\_Type/AccontiCompensatiIntern**

diagram	
namespace	urn:www.agenziaentrate.gov.it:specificheTecniche:sco:730
type	<a href="#">m730:Acoonti_Compensati_Intern_Type</a>
children	<a href="#">m730:PrimaRatalrpef</a> <a href="#">m730:AddizionaleComunale</a> <a href="#">m730:PrimaRataCedolare</a>

element **Altri\_Dati\_Type/RedditiFondariNonImponibili**

diagram					
namespace	urn:www.agenziaentrate.gov.it:specificheTecniche:sco:730				
type	<a href="#">DatoNP_Type</a>				
facets	<table border="1"> <thead> <tr> <th>Kind</th> <th>Value</th> </tr> </thead> <tbody> <tr> <td>pattern</td> <td>[1-9]{1}[0-9]*</td> </tr> </tbody> </table>	Kind	Value	pattern	[1-9]{1}[0-9]*
Kind	Value				
pattern	[1-9]{1}[0-9]*				

element **Altri\_Dati\_Type/RedditoAbitazionePrincipalePertinenze**

diagram					
namespace	urn:www.agenziaentrate.gov.it:specificheTecniche:sco:730				
type	<a href="#">DatoNP_Type</a>				
facets	<table border="1"> <thead> <tr> <th>Kind</th> <th>Value</th> </tr> </thead> <tbody> <tr> <td>pattern</td> <td>[1-9]{1}[0-9]*</td> </tr> </tbody> </table>	Kind	Value	pattern	[1-9]{1}[0-9]*
Kind	Value				
pattern	[1-9]{1}[0-9]*				

element **Altri\_Dati\_Type/ResiduoDeduzioneSommeRestituite**

diagram					
namespace	urn:www.agenziaentrate.gov.it:specificheTecniche:sco:730				
type	<a href="#">DatoNP_Type</a>				
facets	<table border="1"> <thead> <tr> <th>Kind</th> <th>Value</th> </tr> </thead> <tbody> <tr> <td>pattern</td> <td>[1-9]{1}[0-9]*</td> </tr> </tbody> </table>	Kind	Value	pattern	[1-9]{1}[0-9]*
Kind	Value				
pattern	[1-9]{1}[0-9]*				

element **Altri\_Dati\_Type/ResiduoErogazioniScuola**

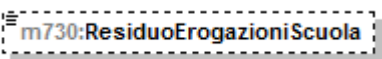
diagram	
namespace	urn:www.agenziaentrate.gov.it:specificheTecniche:sco:730
type	<a href="#">DatoNP_Type</a>
facets	Kind Value pattern [1-9]{1}[0-9]*

element **Altri\_Dati\_Type/ResiduoCreditoNegoziazione**

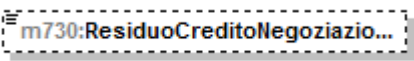
diagram	
namespace	urn:www.agenziaentrate.gov.it:specificheTecniche:sco:730
type	<a href="#">DatoNP_Type</a>
facets	Kind Value pattern [1-9]{1}[0-9]*

element **Altri\_Dati\_Type/ResiduoCreditoVideosorveglianza**

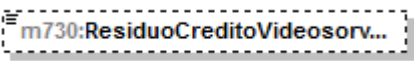
diagram	
namespace	urn:www.agenziaentrate.gov.it:specificheTecniche:sco:730
type	<a href="#">DatoNP_Type</a>
facets	Kind Value pattern [1-9]{1}[0-9]*

element **Altri\_Dati\_Type/CreditoErogazioneCultura**

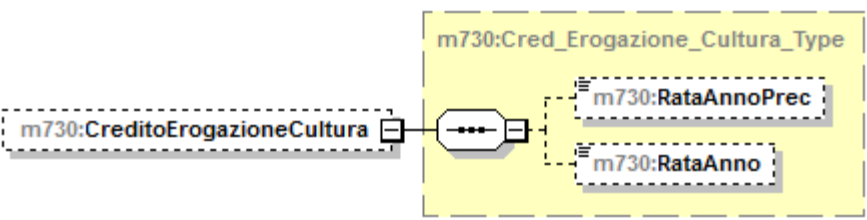
diagram	
namespace	urn:www.agenziaentrate.gov.it:specificheTecniche:sco:730
type	<a href="#">m730:Cred_Erogazione_Cultura_Type</a>
children	<a href="#">m730:RataAnnoPrec</a> <a href="#">m730:RataAnno</a>

complexType **Altri\_Oneri\_Type**

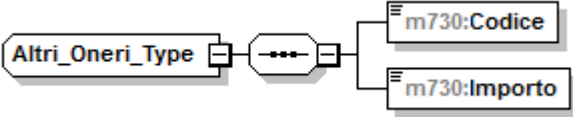
diagram	
namespace	urn:www.agenziaentrate.gov.it:specificheTecniche:sco:730
children	<a href="#">m730:Codice</a> <a href="#">m730:Importo</a>

element **Altri\_Oneri\_Type/Codice**

diagram																			
namespace	urn:www.agenziaentrate.gov.it:specificheTecniche:sco:730																		
type	<a href="#">m730:Codice Altri_Oneri_Type</a>																		
facets	<table border="1"> <thead> <tr> <th>Kind</th> <th>Value</th> </tr> </thead> <tbody> <tr> <td>pattern</td> <td>[1-9]{1}[0-9]*</td> </tr> <tr> <td>enumeration</td> <td>6</td> </tr> <tr> <td>enumeration</td> <td>7</td> </tr> <tr> <td>enumeration</td> <td>8</td> </tr> <tr> <td>enumeration</td> <td>9</td> </tr> <tr> <td>enumeration</td> <td>12</td> </tr> <tr> <td>enumeration</td> <td>13</td> </tr> <tr> <td>enumeration</td> <td>21</td> </tr> </tbody> </table>	Kind	Value	pattern	[1-9]{1}[0-9]*	enumeration	6	enumeration	7	enumeration	8	enumeration	9	enumeration	12	enumeration	13	enumeration	21
Kind	Value																		
pattern	[1-9]{1}[0-9]*																		
enumeration	6																		
enumeration	7																		
enumeration	8																		
enumeration	9																		
enumeration	12																		
enumeration	13																		
enumeration	21																		

element **Altri\_Oneri\_Type/Importo**

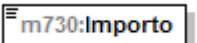
diagram					
namespace	urn:www.agenziaentrate.gov.it:specificheTecniche:sco:730				
type	<a href="#">DatoNP_Type</a>				
facets	<table border="1"> <thead> <tr> <th>Kind</th> <th>Value</th> </tr> </thead> <tbody> <tr> <td>pattern</td> <td>[1-9]{1}[0-9]*</td> </tr> </tbody> </table>	Kind	Value	pattern	[1-9]{1}[0-9]*
Kind	Value				
pattern	[1-9]{1}[0-9]*				

complexType **Altri\_Redditi\_Ass\_Lav\_Type**

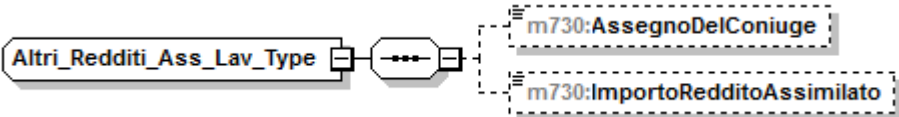
diagram	
namespace	urn:www.agenziaentrate.gov.it:specificheTecniche:sco:730
children	<a href="#">m730:AssegnoDelConiuge</a> <a href="#">m730:ImportoRedditoAssimilato</a>

element **Altri\_Redditi\_Ass\_Lav\_Type/AssegnoDelConiuge**

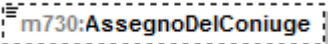
diagram	
---------	---

namespace	urn:www.agenziaentrate.gov.it:specificheTecniche:sco:730				
type	<a href="#">DatoCB_Type</a>				
facets	<table border="1"> <thead> <tr> <th>Kind</th> <th>Value</th> </tr> </thead> <tbody> <tr> <td>pattern</td> <td>[01]</td> </tr> </tbody> </table>	Kind	Value	pattern	[01]
Kind	Value				
pattern	[01]				

element **Altri\_Reddito\_Ass\_Lav\_Type/ImportoRedditoAssimilato**

diagram					
namespace	urn:www.agenziaentrate.gov.it:specificheTecniche:sco:730				
type	<a href="#">DatoNP_Type</a>				
facets	<table border="1"> <thead> <tr> <th>Kind</th> <th>Value</th> </tr> </thead> <tbody> <tr> <td>pattern</td> <td>[1-9]{1}[0-9]*</td> </tr> </tbody> </table>	Kind	Value	pattern	[1-9]{1}[0-9]*
Kind	Value				
pattern	[1-9]{1}[0-9]*				

complexType **Altri\_Reddito\_Diversi\_Detr\_Type**

diagram	
namespace	urn:www.agenziaentrate.gov.it:specificheTecniche:sco:730
children	<a href="#">m730:Tipo_Reddito</a> <a href="#">m730:RedditoRitenuteSpese</a>

element **Altri\_Reddito\_Diversi\_Detr\_Type/Tipo\_Reddito**

diagram													
namespace	urn:www.agenziaentrate.gov.it:specificheTecniche:sco:730												
type	<a href="#">m730:Tipo_Reddito_Da1a4_Type</a>												
facets	<table border="1"> <thead> <tr> <th>Kind</th> <th>Value</th> </tr> </thead> <tbody> <tr> <td>pattern</td> <td>[1-9]</td> </tr> <tr> <td>enumeration</td> <td>1</td> </tr> <tr> <td>enumeration</td> <td>2</td> </tr> <tr> <td>enumeration</td> <td>3</td> </tr> <tr> <td>enumeration</td> <td>4</td> </tr> </tbody> </table>	Kind	Value	pattern	[1-9]	enumeration	1	enumeration	2	enumeration	3	enumeration	4
Kind	Value												
pattern	[1-9]												
enumeration	1												
enumeration	2												
enumeration	3												
enumeration	4												



element **Altri\_Reddit\_Diversi\_Detr\_Type/RedditiRitenuteSpese**

diagram	
namespace	urn:www.agenziaentrate.gov.it:specificheTecniche:sco:730
type	<a href="#">m730:Redditi_Ritenute_Spese_Type</a>
children	<a href="#">m730:ImportoRedditi</a> <a href="#">m730:ImportoRitenute</a> <a href="#">m730:ImportoSpese</a>

complexType **Altri\_Reddit\_Diversi\_Type**

diagram	
namespace	urn:www.agenziaentrate.gov.it:specificheTecniche:sco:730
children	<a href="#">m730:CedolareSecca</a> <a href="#">m730:TipoReddito</a> <a href="#">m730:RedditiRitenuteSpese</a>

element **Altri\_Reddit\_Diversi\_Type/CedolareSecca**

diagram					
namespace	urn:www.agenziaentrate.gov.it:specificheTecniche:sco:730				
type	<a href="#">DatoCB_Type</a>				
facets	<table border="1"> <thead> <tr> <th>Kind</th> <th>Value</th> </tr> </thead> <tbody> <tr> <td>pattern</td> <td>[01]</td> </tr> </tbody> </table>	Kind	Value	pattern	[01]
Kind	Value				
pattern	[01]				

element **Altri\_Reddit\_Diversi\_Type/TipoReddito**

diagram													
namespace	urn:www.agenziaentrate.gov.it:specificheTecniche:sco:730												
type	restriction of <a href="#">DatoNP_Type</a>												
facets	<table border="1"> <thead> <tr> <th>Kind</th> <th>Value</th> </tr> </thead> <tbody> <tr> <td>pattern</td> <td>[1-9]{1}[0-9]*</td> </tr> <tr> <td>enumeration</td> <td>1</td> </tr> <tr> <td>enumeration</td> <td>2</td> </tr> <tr> <td>enumeration</td> <td>3</td> </tr> <tr> <td>enumeration</td> <td>4</td> </tr> </tbody> </table>	Kind	Value	pattern	[1-9]{1}[0-9]*	enumeration	1	enumeration	2	enumeration	3	enumeration	4
Kind	Value												
pattern	[1-9]{1}[0-9]*												
enumeration	1												
enumeration	2												
enumeration	3												
enumeration	4												

	enumeration	5
	enumeration	6
	enumeration	7
	enumeration	8
	enumeration	9
	enumeration	10

element **Altri\_Reddi\_Diversi\_Type/ReddiRitenuteSpese**

diagram	
namespace	urn:www.agenziaentrate.gov.it:specificheTecniche:sco:730
type	<a href="#">m730:Reddi_Ritenute_Spese_Type</a>
children	<a href="#">m730:ImportoReddi</a> <a href="#">m730:ImportoRitenute</a> <a href="#">m730:ImportoSpese</a>

complexType **Altri\_Reddi\_Lavoro\_Autonomo\_Type**

diagram	
namespace	urn:www.agenziaentrate.gov.it:specificheTecniche:sco:730
children	<a href="#">m730:TipoReddito</a> <a href="#">m730:ReddiRitenute</a>

element **Altri\_Reddi\_Lavoro\_Autonomo\_Type/TipoReddito**

diagram													
namespace	urn:www.agenziaentrate.gov.it:specificheTecniche:sco:730												
type	<a href="#">m730:Tipo_Reddito_Da1a4_Type</a>												
facets	<table border="1"> <thead> <tr> <th>Kind</th> <th>Value</th> </tr> </thead> <tbody> <tr> <td>pattern</td> <td>[1-9]</td> </tr> <tr> <td>enumeration</td> <td>1</td> </tr> <tr> <td>enumeration</td> <td>2</td> </tr> <tr> <td>enumeration</td> <td>3</td> </tr> <tr> <td>enumeration</td> <td>4</td> </tr> </tbody> </table>	Kind	Value	pattern	[1-9]	enumeration	1	enumeration	2	enumeration	3	enumeration	4
Kind	Value												
pattern	[1-9]												
enumeration	1												
enumeration	2												
enumeration	3												
enumeration	4												

element **Altri\_Reddi\_Lavoro\_Autonomo\_Type/ReddiRitenute**

diagram	<p>The diagram shows a dashed box labeled 'm730:ReddiRitenute' connected to a solid box labeled 'm730:Reddi_Ritenute_Type'. Inside the solid box, there are two dashed boxes: 'm730:ImportoReddi' and 'm730:ImportoRitenute'.</p>
namespace	urn:www.agenziaentrate.gov.it:specificheTecniche:sco:730
type	<a href="#">m730:Reddi_Ritenute_Type</a>
children	<a href="#">m730:ImportoReddi</a> <a href="#">m730:ImportoRitenute</a>

complexType **Altri\_Reddi\_Type**

diagram	<p>The diagram shows a solid box labeled 'Altri_Reddi_Type' with the text 'Quadro D - Altri Reddi' below it. It is connected to a solid box labeled 'm730:Modulo' with '1..∞' below it.</p>
namespace	urn:www.agenziaentrate.gov.it:specificheTecniche:sco:730
children	<a href="#">m730:Modulo</a>

element **Altri\_Reddi\_Type/Modulo**

diagram	<p>The diagram shows a solid box labeled 'm730:Modulo' with '1..∞' below it, connected to a dashed box labeled 'm730:Modulo_Altri_Reddi_Type'. Inside the dashed box, there are two solid boxes: 'm730:ReddiDiCapitale' and 'm730:ReddiTassazioneSeparata', both with a '+' sign.</p>
namespace	urn:www.agenziaentrate.gov.it:specificheTecniche:sco:730
type	<a href="#">m730:Modulo Altri_Reddi_Type</a>
children	<a href="#">m730:ReddiDiCapitale</a> <a href="#">m730:ReddiTassazioneSeparata</a>

complexType **Altri\_Reddi\_Utili\_Type**

diagram	<p>The diagram shows a solid box labeled 'Altri_Reddi_Utili_Type' connected to a solid box labeled 'm730:Tipo_Reddito' and a dashed box labeled 'm730:ReddiRitenute' with a '+' sign.</p>
namespace	urn:www.agenziaentrate.gov.it:specificheTecniche:sco:730
children	<a href="#">m730:Tipo_Reddito</a> <a href="#">m730:ReddiRitenute</a>

element **Altri\_Reddito\_Utili\_Type/Tipo\_Reddito**

diagram																											
namespace	urn:www.agenziaentrate.gov.it:specificheTecniche:sco:730																										
type	restriction of <a href="#">DatoNP_Type</a>																										
facets	<table border="1"> <thead> <tr> <th>Kind</th> <th>Value</th> </tr> </thead> <tbody> <tr> <td>pattern</td> <td>[1-9]{1}[0-9]*</td> </tr> <tr> <td>enumeration</td> <td>1</td> </tr> <tr> <td>enumeration</td> <td>2</td> </tr> <tr> <td>enumeration</td> <td>3</td> </tr> <tr> <td>enumeration</td> <td>4</td> </tr> <tr> <td>enumeration</td> <td>5</td> </tr> <tr> <td>enumeration</td> <td>6</td> </tr> <tr> <td>enumeration</td> <td>7</td> </tr> <tr> <td>enumeration</td> <td>8</td> </tr> <tr> <td>enumeration</td> <td>9</td> </tr> <tr> <td>enumeration</td> <td>10</td> </tr> <tr> <td>enumeration</td> <td>11</td> </tr> </tbody> </table>	Kind	Value	pattern	[1-9]{1}[0-9]*	enumeration	1	enumeration	2	enumeration	3	enumeration	4	enumeration	5	enumeration	6	enumeration	7	enumeration	8	enumeration	9	enumeration	10	enumeration	11
Kind	Value																										
pattern	[1-9]{1}[0-9]*																										
enumeration	1																										
enumeration	2																										
enumeration	3																										
enumeration	4																										
enumeration	5																										
enumeration	6																										
enumeration	7																										
enumeration	8																										
enumeration	9																										
enumeration	10																										
enumeration	11																										

element **Altri\_Reddito\_Utili\_Type/RedditiRitenute**

diagram	
namespace	urn:www.agenziaentrate.gov.it:specificheTecniche:sco:730
type	<a href="#">m730:Redditi_Ritenute_Type</a>
children	<a href="#">m730:ImportoRedditi</a> <a href="#">m730:ImportoRitenute</a>

complexType **Annotazione\_Type**

diagram	
namespace	urn:www.agenziaentrate.gov.it:specificheTecniche:sco:730
children	<a href="#">m730:Codice</a> <a href="#">m730:RigoQuadro</a> <a href="#">m730:ModuloQuadro</a> <a href="#">m730:Importo</a>

### element **Annotazione\_Type/Codice**

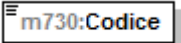
diagram					
namespace	urn:www.agenziaentrate.gov.it:specificheTecniche:sco:730				
type	<a href="#">DatoAN_Type</a>				
facets	<table border="1"> <tr> <td>Kind</td> <td>Value</td> </tr> <tr> <td>pattern</td> <td>(([0-9A-Z\-\] \&amp;quot;){1}([ 0-9A-Z&amp;amp;:] \-\ \., / \^\ \(\ \)\ À É È Ì Ò Ù Ü &amp;quot; \ \\ \ +)*</td> </tr> </table>	Kind	Value	pattern	(([0-9A-Z\-\] \&quot;){1}([ 0-9A-Z&amp;:] \-\ \., / \^\ \(\ \)\ À É È Ì Ò Ù Ü &quot; \ \\ \ +)*
Kind	Value				
pattern	(([0-9A-Z\-\] \&quot;){1}([ 0-9A-Z&amp;:] \-\ \., / \^\ \(\ \)\ À É È Ì Ò Ù Ü &quot; \ \\ \ +)*				

### element **Annotazione\_Type/RigoQuadro**

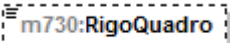
diagram					
namespace	urn:www.agenziaentrate.gov.it:specificheTecniche:sco:730				
type	<a href="#">DatoNP_Type</a>				
facets	<table border="1"> <tr> <td>Kind</td> <td>Value</td> </tr> <tr> <td>pattern</td> <td>[1-9]{1}[0-9]*</td> </tr> </table>	Kind	Value	pattern	[1-9]{1}[0-9]*
Kind	Value				
pattern	[1-9]{1}[0-9]*				

### element **Annotazione\_Type/ModuloQuadro**

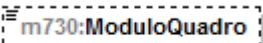
diagram					
namespace	urn:www.agenziaentrate.gov.it:specificheTecniche:sco:730				
type	<a href="#">DatoNP_Type</a>				
facets	<table border="1"> <tr> <td>Kind</td> <td>Value</td> </tr> <tr> <td>pattern</td> <td>[1-9]{1}[0-9]*</td> </tr> </table>	Kind	Value	pattern	[1-9]{1}[0-9]*
Kind	Value				
pattern	[1-9]{1}[0-9]*				

### element **Annotazione\_Type/Importo**

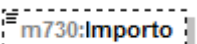
diagram					
namespace	urn:www.agenziaentrate.gov.it:specificheTecniche:sco:730				
type	<a href="#">DatoNP_Type</a>				
facets	<table border="1"> <tr> <td>Kind</td> <td>Value</td> </tr> <tr> <td>pattern</td> <td>[1-9]{1}[0-9]*</td> </tr> </table>	Kind	Value	pattern	[1-9]{1}[0-9]*
Kind	Value				
pattern	[1-9]{1}[0-9]*				

### complexType **Assegno\_Coniuge\_Type**

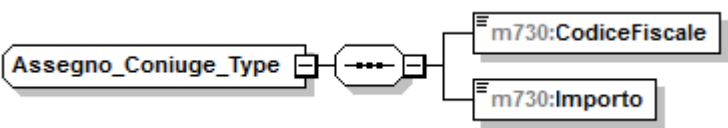
diagram	
namespace	urn:www.agenziaentrate.gov.it:specificheTecniche:sco:730
children	<a href="#">m730:CodiceFiscale</a> <a href="#">m730:Importo</a>

element **Assegno\_Coniuge\_Type/CodiceFiscale**

diagram					
namespace	urn:www.agenziaentrate.gov.it:specificheTecniche:sco:730				
type	<a href="#">DatoCF_Type</a>				
facets	<table border="1"> <thead> <tr> <th>Kind</th> <th>Value</th> </tr> </thead> <tbody> <tr> <td>pattern</td> <td>[0-9]{1}[A-Z]{6}[0-9LMNPQRSTU]{2}[A-Z]{1}[0-9LMNPQRSTU]{2}[A-Z]{1}[0-9LMNPQRSTU]{3}[A-Z]{1}</td> </tr> </tbody> </table>	Kind	Value	pattern	[0-9]{1}[A-Z]{6}[0-9LMNPQRSTU]{2}[A-Z]{1}[0-9LMNPQRSTU]{2}[A-Z]{1}[0-9LMNPQRSTU]{3}[A-Z]{1}
Kind	Value				
pattern	[0-9]{1}[A-Z]{6}[0-9LMNPQRSTU]{2}[A-Z]{1}[0-9LMNPQRSTU]{2}[A-Z]{1}[0-9LMNPQRSTU]{3}[A-Z]{1}				

element **Assegno\_Coniuge\_Type/Importo**

diagram					
namespace	urn:www.agenziaentrate.gov.it:specificheTecniche:sco:730				
type	<a href="#">DatoNP_Type</a>				
facets	<table border="1"> <thead> <tr> <th>Kind</th> <th>Value</th> </tr> </thead> <tbody> <tr> <td>pattern</td> <td>[1-9]{1}[0-9]*</td> </tr> </tbody> </table>	Kind	Value	pattern	[1-9]{1}[0-9]*
Kind	Value				
pattern	[1-9]{1}[0-9]*				

complexType **Bonus\_Irpef\_Type**

diagram	
namespace	urn:www.agenziaentrate.gov.it:specificheTecniche:sco:730
children	<a href="#">m730:CodiceBonus</a> <a href="#">m730:BonusErogato</a> <a href="#">m730:Esenzione</a> <a href="#">m730:QuotaTfr</a>

element **Bonus\_Irpef\_Type/CodiceBonus**

diagram									
namespace	urn:www.agenziaentrate.gov.it:specificheTecniche:sco:730								
type	restriction of <a href="#">DatoN1_Type</a>								
facets	<table border="1"> <thead> <tr> <th>Kind</th> <th>Value</th> </tr> </thead> <tbody> <tr> <td>pattern</td> <td>[1-9]</td> </tr> <tr> <td>enumeration</td> <td>1</td> </tr> <tr> <td>enumeration</td> <td>2</td> </tr> </tbody> </table>	Kind	Value	pattern	[1-9]	enumeration	1	enumeration	2
Kind	Value								
pattern	[1-9]								
enumeration	1								
enumeration	2								

element **Bonus\_Irpef\_Type/BonusErogato**

diagram					
namespace	urn:www.agenziaentrate.gov.it:specificheTecniche:sco:730				
type	<a href="#">DatoNP_Type</a>				
facets	<table border="1"> <tr> <td>Kind</td> <td>Value</td> </tr> <tr> <td>pattern</td> <td>[1-9]{1}[0-9]*</td> </tr> </table>	Kind	Value	pattern	[1-9]{1}[0-9]*
Kind	Value				
pattern	[1-9]{1}[0-9]*				

element **Bonus\_Irpef\_Type/Esenzione**

diagram	
namespace	urn:www.agenziaentrate.gov.it:specificheTecniche:sco:730
type	<a href="#">m730:Esenzione Bonus_Type</a>
children	<a href="#">m730:TipologiaEsenzione</a> <a href="#">m730:ParteRedditoEsente</a>

element **Bonus\_Irpef\_Type/QuotaTfr**

diagram					
namespace	urn:www.agenziaentrate.gov.it:specificheTecniche:sco:730				
type	<a href="#">DatoNP_Type</a>				
facets	<table border="1"> <tr> <td>Kind</td> <td>Value</td> </tr> <tr> <td>pattern</td> <td>[1-9]{1}[0-9]*</td> </tr> </table>	Kind	Value	pattern	[1-9]{1}[0-9]*
Kind	Value				
pattern	[1-9]{1}[0-9]*				

complexType **Casella\_Acconto\_Type**

diagram	
namespace	urn:www.agenziaentrate.gov.it:specificheTecniche:sco:730
children	<a href="#">m730:Casella</a> <a href="#">m730:ImportoMisuraInferiore</a>

element **Casella\_Acconto\_Type/Casella**

diagram	
---------	--

namespace	urn:www.agenziaentrate.gov.it:specificheTecniche:sco:730
type	<a href="#">DatoCB_Type</a>
facets	Kind Value pattern [01]

#### element **Casella\_Acconto\_Type/ImportoMisuralInferiore**

diagram	
namespace	urn:www.agenziaentrate.gov.it:specificheTecniche:sco:730
type	<a href="#">DatoNP_Type</a>
facets	Kind Value pattern [1-9]{1}[0-9]*

#### complexType **Cedolare\_Secca\_Type**

diagram	
namespace	urn:www.agenziaentrate.gov.it:specificheTecniche:sco:730
children	<a href="#">m730:CedolareDovuta</a> <a href="#">m730:CedolareDifferenza</a> <a href="#">m730:EccedenzaCedolareSecca</a> <a href="#">m730:AccontoCedolare</a>

#### element **Cedolare\_Secca\_Type/CedolareDovuta**

diagram	
namespace	urn:www.agenziaentrate.gov.it:specificheTecniche:sco:730
type	<a href="#">DatoNP_Type</a>
facets	Kind Value pattern [1-9]{1}[0-9]*

#### element **Cedolare\_Secca\_Type/CedolareDifferenza**

diagram	
namespace	urn:www.agenziaentrate.gov.it:specificheTecniche:sco:730
type	<a href="#">DatoNP_Type</a>
facets	Kind Value pattern [1-9]{1}[0-9]*



element **Cedolare\_Secca\_Type/EccedenzaCedolareSecca**

diagram	
namespace	urn:www.agenziaentrate.gov.it:specificheTecniche:sco:730
type	<a href="#">DatoNU_Type</a>
facets	Kind Value pattern $(\backslash-[1-9][[1-9]][0-9]^*$

element **Cedolare\_Secca\_Type/AccontoCedolare**

diagram	
namespace	urn:www.agenziaentrate.gov.it:specificheTecniche:sco:730
type	<a href="#">DatoNP_Type</a>
facets	Kind Value pattern $[1-9]\{1\}[0-9]^*$

complexType **Comunicazione\_Amministratore\_Type**

diagram	
namespace	urn:www.agenziaentrate.gov.it:specificheTecniche:sco:730
children	<a href="#">m730:Modulo</a>

element **Comunicazione\_Amministratore\_Type/Modulo**

diagram	
namespace	urn:www.agenziaentrate.gov.it:specificheTecniche:sco:730
type	<a href="#">m730:Modulo_Comunicazione_Type</a>
children	<a href="#">m730:DatiCondominio</a> <a href="#">m730:DatiCatastali</a> <a href="#">m730:DomandaAccatamento</a> <a href="#">m730:DatiFornitore</a>

complexType **Conguaglio\_Type**

diagram	
namespace	urn:www.agenziaentrate.gov.it:specificheTecniche:sco:730
children	<a href="#">m730:NumeroRate</a> <a href="#">m730:ImportoTrattenutoSaldo</a> <a href="#">m730:ImportoTrattenutoAcconto</a> <a href="#">m730:ImportoDaVersareF24Saldo</a> <a href="#">m730:ImportoDaVersareF24Acc...</a> <a href="#">m730:ImportoRimborsato</a> <a href="#">m730:ImportoRimborsatoAgenzia</a> <a href="#">m730:OpzioneInformativa</a>

element **Conguaglio\_Type/NumeroRate**

diagram																	
namespace	urn:www.agenziaentrate.gov.it:specificheTecniche:sco:730																
type	restriction of <a href="#">DatoN1_Type</a>																
facets	<table border="1"> <thead> <tr> <th>Kind</th> <th>Value</th> </tr> </thead> <tbody> <tr> <td>pattern</td> <td>[1-9]</td> </tr> <tr> <td>enumeration</td> <td>2</td> </tr> <tr> <td>enumeration</td> <td>3</td> </tr> <tr> <td>enumeration</td> <td>4</td> </tr> <tr> <td>enumeration</td> <td>5</td> </tr> <tr> <td>enumeration</td> <td>6</td> </tr> <tr> <td>enumeration</td> <td>7</td> </tr> </tbody> </table>	Kind	Value	pattern	[1-9]	enumeration	2	enumeration	3	enumeration	4	enumeration	5	enumeration	6	enumeration	7
Kind	Value																
pattern	[1-9]																
enumeration	2																
enumeration	3																
enumeration	4																
enumeration	5																
enumeration	6																
enumeration	7																

element **Conguaglio\_Type/ImportoTrattenutoSaldo**

diagram					
namespace	urn:www.agenziaentrate.gov.it:specificheTecniche:sco:730				
type	<a href="#">DatoNP_Type</a>				
facets	<table border="1"> <thead> <tr> <th>Kind</th> <th>Value</th> </tr> </thead> <tbody> <tr> <td>pattern</td> <td>[1-9]{1}[0-9]*</td> </tr> </tbody> </table>	Kind	Value	pattern	[1-9]{1}[0-9]*
Kind	Value				
pattern	[1-9]{1}[0-9]*				

**element Conguaglio\_Type/ImportoTrattenutoAcconto**

diagram					
namespace	urn:www.agenziaentrate.gov.it:specificheTecniche:sco:730				
type	<a href="#">DatoNP_Type</a>				
facets	<table border="1"> <tr> <td>Kind</td> <td>Value</td> </tr> <tr> <td>pattern</td> <td>[1-9]{1}[0-9]*</td> </tr> </table>	Kind	Value	pattern	[1-9]{1}[0-9]*
Kind	Value				
pattern	[1-9]{1}[0-9]*				

**element Conguaglio\_Type/ImportoDaVersareF24Saldo**

diagram					
namespace	urn:www.agenziaentrate.gov.it:specificheTecniche:sco:730				
type	<a href="#">DatoNP_Type</a>				
facets	<table border="1"> <tr> <td>Kind</td> <td>Value</td> </tr> <tr> <td>pattern</td> <td>[1-9]{1}[0-9]*</td> </tr> </table>	Kind	Value	pattern	[1-9]{1}[0-9]*
Kind	Value				
pattern	[1-9]{1}[0-9]*				

**element Conguaglio\_Type/ImportoDaVersareF24Acconto**

diagram					
namespace	urn:www.agenziaentrate.gov.it:specificheTecniche:sco:730				
type	<a href="#">DatoNP_Type</a>				
facets	<table border="1"> <tr> <td>Kind</td> <td>Value</td> </tr> <tr> <td>pattern</td> <td>[1-9]{1}[0-9]*</td> </tr> </table>	Kind	Value	pattern	[1-9]{1}[0-9]*
Kind	Value				
pattern	[1-9]{1}[0-9]*				

**element Conguaglio\_Type/ImportoRimborsato**

diagram					
namespace	urn:www.agenziaentrate.gov.it:specificheTecniche:sco:730				
type	<a href="#">DatoNP_Type</a>				
facets	<table border="1"> <tr> <td>Kind</td> <td>Value</td> </tr> <tr> <td>pattern</td> <td>[1-9]{1}[0-9]*</td> </tr> </table>	Kind	Value	pattern	[1-9]{1}[0-9]*
Kind	Value				
pattern	[1-9]{1}[0-9]*				

**element Conguaglio\_Type/ImportoRimborsatoAgenzia**

diagram					
namespace	urn:www.agenziaentrate.gov.it:specificheTecniche:sco:730				
type	<a href="#">DatoNP_Type</a>				
facets	<table border="1"> <tr> <td>Kind</td> <td>Value</td> </tr> <tr> <td>pattern</td> <td>[1-9]{1}[0-9]*</td> </tr> </table>	Kind	Value	pattern	[1-9]{1}[0-9]*
Kind	Value				
pattern	[1-9]{1}[0-9]*				

**element Conguaglio\_Type/OpzioneInformativa**

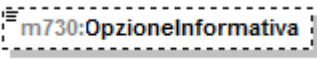
diagram	
namespace	urn:www.agenziaentrate.gov.it:specificheTecniche:sco:730
type	<a href="#">DatoCB_Type</a>
facets	Kind Value pattern [01]

**complexType Contributi\_Previdenza\_Complementare\_Type**

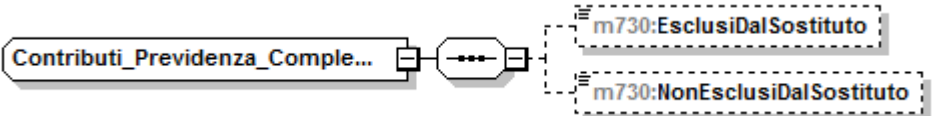
diagram	
namespace	urn:www.agenziaentrate.gov.it:specificheTecniche:sco:730
children	<a href="#">m730:EsclusiDalSostituto</a> <a href="#">m730:NonEsclusiDalSostituto</a>

**element Contributi\_Previdenza\_Complementare\_Type/EsclusiDalSostituto**

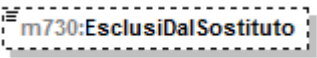
diagram	
namespace	urn:www.agenziaentrate.gov.it:specificheTecniche:sco:730
type	<a href="#">DatoNP_Type</a>
facets	Kind Value pattern [1-9]{1}[0-9]*

**element Contributi\_Previdenza\_Complementare\_Type/NonEsclusiDalSostituto**

diagram	
namespace	urn:www.agenziaentrate.gov.it:specificheTecniche:sco:730
type	<a href="#">DatoNP_Type</a>
facets	Kind Value pattern [1-9]{1}[0-9]*

complexType **Contributo\_Solidarieta\_Type**

diagram	
namespace	urn:www.agenziaentrate.gov.it:specificheTecniche:sco:730
children	<a href="#">m730:ImponibileContributo</a> <a href="#">m730:ContributoDovuto</a> <a href="#">m730:ContributoCertificaz</a>

element **Contributo\_Solidarieta\_Type/ImponibileContributo**

diagram					
namespace	urn:www.agenziaentrate.gov.it:specificheTecniche:sco:730				
type	<a href="#">DatoNP_Type</a>				
facets	<table border="1"> <tr> <td>Kind</td> <td>Value</td> </tr> <tr> <td>pattern</td> <td>[1-9]{1}[0-9]*</td> </tr> </table>	Kind	Value	pattern	[1-9]{1}[0-9]*
Kind	Value				
pattern	[1-9]{1}[0-9]*				

element **Contributo\_Solidarieta\_Type/ContributoDovuto**

diagram					
namespace	urn:www.agenziaentrate.gov.it:specificheTecniche:sco:730				
type	<a href="#">DatoNP_Type</a>				
facets	<table border="1"> <tr> <td>Kind</td> <td>Value</td> </tr> <tr> <td>pattern</td> <td>[1-9]{1}[0-9]*</td> </tr> </table>	Kind	Value	pattern	[1-9]{1}[0-9]*
Kind	Value				
pattern	[1-9]{1}[0-9]*				

element **Contributo\_Solidarieta\_Type/ContributoCertificaz**

diagram					
namespace	urn:www.agenziaentrate.gov.it:specificheTecniche:sco:730				
type	<a href="#">DatoNP_Type</a>				
facets	<table border="1"> <tr> <td>Kind</td> <td>Value</td> </tr> <tr> <td>pattern</td> <td>[1-9]{1}[0-9]*</td> </tr> </table>	Kind	Value	pattern	[1-9]{1}[0-9]*
Kind	Value				
pattern	[1-9]{1}[0-9]*				

complexType **Cred\_Erogazione\_Cultura\_Type**

diagram	
namespace	urn:www.agenziaentrate.gov.it:specificheTecniche:sco:730

children	<a href="#">m730:RataAnnoPrec</a> <a href="#">m730:RataAnno</a>
----------	---

**element Cred\_Erogazione\_Cultura\_Type/RataAnnoPrec**

diagram	
namespace	urn:www.agenziaentrate.gov.it:specificheTecniche:sco:730
type	<a href="#">DatoNP_Type</a>
facets	Kind Value pattern [1-9]{1}[0-9]*

**element Cred\_Erogazione\_Cultura\_Type/RataAnno**

diagram	
namespace	urn:www.agenziaentrate.gov.it:specificheTecniche:sco:730
type	<a href="#">DatoNP_Type</a>
facets	Kind Value pattern [1-9]{1}[0-9]*

**complexType Cred\_Imp\_Estero\_Type**

diagram	
namespace	urn:www.agenziaentrate.gov.it:specificheTecniche:sco:730
children	<a href="#">m730:Anno</a> <a href="#">m730:TotCredito</a> <a href="#">m730:CreditoStato</a>

**element Cred\_Imp\_Estero\_Type/Anno**

diagram	
namespace	urn:www.agenziaentrate.gov.it:specificheTecniche:sco:730
type	<a href="#">DatoDA_Type</a>
facets	Kind Value pattern (18 19 20)[0-9]{2}

element **Cred\_Imp\_Estero\_Type/TotCredito**

diagram	
namespace	urn:www.agenziaentrate.gov.it:specificheTecniche:sco:730
type	<a href="#">DatoNP_Type</a>
facets	Kind Value pattern [1-9]{1}[0-9]*

element **Cred\_Imp\_Estero\_Type/CreditoStato**

diagram	
namespace	urn:www.agenziaentrate.gov.it:specificheTecniche:sco:730
type	<a href="#">m730:Credito_Stato_Type</a>
children	<a href="#">m730:Stato</a> <a href="#">m730:Credito</a>

complexType **Crediti\_F24\_Type**

diagram	
namespace	urn:www.agenziaentrate.gov.it:specificheTecniche:sco:730
children	<a href="#">m730:Credlrpef</a> <a href="#">m730:CredlrpefDipNoSostituto</a> <a href="#">m730:CodAddReg</a> <a href="#">m730:CredAddReg</a> <a href="#">m730:CredAddRegDipNoSostituto</a> <a href="#">m730:CodiceAddCom</a> <a href="#">m730:CredAddCom</a> <a href="#">m730:CredAddComDipNoSostituto</a> <a href="#">m730:CredCedolare</a> <a href="#">m730:CredCedolareDipNoSostituto</a> <a href="#">m730:CredTassSeparDipNoSostituto</a> <a href="#">m730:CredImpostaSostDipNoSostituto</a> <a href="#">m730:Totale</a> <a href="#">m730:TotaleDipNoSostituto</a>

element **Crediti\_F24\_Type/Credlrpef**

diagram					
namespace	urn:www.agenziaentrate.gov.it:specificheTecniche:sco:730				
type	<a href="#">DatoNP_Type</a>				
facets	<table border="1"> <tr> <td>Kind</td> <td>Value</td> </tr> <tr> <td>pattern</td> <td>[1-9]{1}[0-9]*</td> </tr> </table>	Kind	Value	pattern	[1-9]{1}[0-9]*
Kind	Value				
pattern	[1-9]{1}[0-9]*				

element **Crediti\_F24\_Type/CredlrpefDipNoSostituto**

diagram	
---------	--



namespace	urn:www.agenziaentrate.gov.it:specificheTecniche:sco:730				
type	<a href="#">DatoNP_Type</a>				
facets	<table border="1"> <thead> <tr> <th>Kind</th> <th>Value</th> </tr> </thead> <tbody> <tr> <td>pattern</td> <td>[1-9]{1}[0-9]*</td> </tr> </tbody> </table>	Kind	Value	pattern	[1-9]{1}[0-9]*
Kind	Value				
pattern	[1-9]{1}[0-9]*				

#### element **Crediti\_F24\_Type/CodAddReg**

diagram																																															
namespace	urn:www.agenziaentrate.gov.it:specificheTecniche:sco:730																																														
type	<a href="#">Codice Regione_Type</a>																																														
facets	<table border="1"> <thead> <tr> <th>Kind</th> <th>Value</th> </tr> </thead> <tbody> <tr> <td>pattern</td> <td>([0-9A-Z\-\ ]&amp;quot;){1}([ 0-9A-Z&amp;amp;] '\- . \./ ° ^\(\\ )À È É Ì Ò Ù Ü &amp;quot; \\ \\+)*</td> </tr> <tr><td>enumeration</td><td>1</td></tr> <tr><td>enumeration</td><td>2</td></tr> <tr><td>enumeration</td><td>3</td></tr> <tr><td>enumeration</td><td>4</td></tr> <tr><td>enumeration</td><td>5</td></tr> <tr><td>enumeration</td><td>6</td></tr> <tr><td>enumeration</td><td>7</td></tr> <tr><td>enumeration</td><td>8</td></tr> <tr><td>enumeration</td><td>9</td></tr> <tr><td>enumeration</td><td>10</td></tr> <tr><td>enumeration</td><td>11</td></tr> <tr><td>enumeration</td><td>12</td></tr> <tr><td>enumeration</td><td>13</td></tr> <tr><td>enumeration</td><td>14</td></tr> <tr><td>enumeration</td><td>15</td></tr> <tr><td>enumeration</td><td>16</td></tr> <tr><td>enumeration</td><td>17</td></tr> <tr><td>enumeration</td><td>18</td></tr> <tr><td>enumeration</td><td>19</td></tr> <tr><td>enumeration</td><td>20</td></tr> <tr><td>enumeration</td><td>21</td></tr> </tbody> </table>	Kind	Value	pattern	([0-9A-Z\-\ ]&quot;){1}([ 0-9A-Z&amp;] '\- . \./ ° ^\(\\ )À È É Ì Ò Ù Ü &quot; \\ \\+)*	enumeration	1	enumeration	2	enumeration	3	enumeration	4	enumeration	5	enumeration	6	enumeration	7	enumeration	8	enumeration	9	enumeration	10	enumeration	11	enumeration	12	enumeration	13	enumeration	14	enumeration	15	enumeration	16	enumeration	17	enumeration	18	enumeration	19	enumeration	20	enumeration	21
Kind	Value																																														
pattern	([0-9A-Z\-\ ]&quot;){1}([ 0-9A-Z&amp;] '\- . \./ ° ^\(\\ )À È É Ì Ò Ù Ü &quot; \\ \\+)*																																														
enumeration	1																																														
enumeration	2																																														
enumeration	3																																														
enumeration	4																																														
enumeration	5																																														
enumeration	6																																														
enumeration	7																																														
enumeration	8																																														
enumeration	9																																														
enumeration	10																																														
enumeration	11																																														
enumeration	12																																														
enumeration	13																																														
enumeration	14																																														
enumeration	15																																														
enumeration	16																																														
enumeration	17																																														
enumeration	18																																														
enumeration	19																																														
enumeration	20																																														
enumeration	21																																														

#### element **Crediti\_F24\_Type/CredAddReg**

diagram					
namespace	urn:www.agenziaentrate.gov.it:specificheTecniche:sco:730				
type	<a href="#">DatoNP_Type</a>				
facets	<table border="1"> <thead> <tr> <th>Kind</th> <th>Value</th> </tr> </thead> <tbody> <tr> <td>pattern</td> <td>[1-9]{1}[0-9]*</td> </tr> </tbody> </table>	Kind	Value	pattern	[1-9]{1}[0-9]*
Kind	Value				
pattern	[1-9]{1}[0-9]*				

#### element **Crediti\_F24\_Type/CredAddRegDipNoSostituto**

diagram					
namespace	urn:www.agenziaentrate.gov.it:specificheTecniche:sco:730				
type	<a href="#">DatoNP_Type</a>				
facets	<table border="1"> <thead> <tr> <th>Kind</th> <th>Value</th> </tr> </thead> <tbody> <tr> <td>pattern</td> <td>[1-9]{1}[0-9]*</td> </tr> </tbody> </table>	Kind	Value	pattern	[1-9]{1}[0-9]*
Kind	Value				
pattern	[1-9]{1}[0-9]*				

**element Crediti\_F24\_Type/CodiceAddCom**

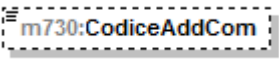
diagram	
namespace	urn:www.agenziaentrate.gov.it:specificheTecniche:sco:730
type	<a href="#">DatoAN_Type</a>
facets	Kind Value pattern ([0-9A-Z- &quot;){1}([ 0-9A-Z&amp;:] \" \- \- _ / ^\\(\\) À É Ì Ò Ù &quot; \\ \\ +)*

**element Crediti\_F24\_Type/CredAddCom**

diagram	
namespace	urn:www.agenziaentrate.gov.it:specificheTecniche:sco:730
type	<a href="#">DatoNP_Type</a>
facets	Kind Value pattern [1-9]{1}[0-9]*

**element Crediti\_F24\_Type/CredAddComDipNoSostituto**

diagram	
namespace	urn:www.agenziaentrate.gov.it:specificheTecniche:sco:730
type	<a href="#">DatoNP_Type</a>
facets	Kind Value pattern [1-9]{1}[0-9]*

**element Crediti\_F24\_Type/CredCedolare**

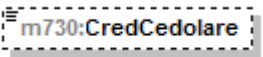
diagram	
namespace	urn:www.agenziaentrate.gov.it:specificheTecniche:sco:730
type	<a href="#">DatoNP_Type</a>
facets	Kind Value pattern [1-9]{1}[0-9]*

**element Crediti\_F24\_Type/CredCedolareDipNoSostituto**

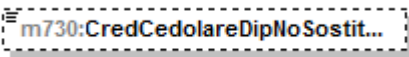
diagram	
namespace	urn:www.agenziaentrate.gov.it:specificheTecniche:sco:730
type	<a href="#">DatoNP_Type</a>

facets	Kind	Value
	pattern	[1-9]{1}[0-9]*

#### element **Crediti\_F24\_Type/CredTassSeparDipNoSostituto**

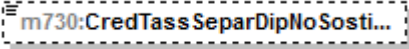
diagram		
namespace	urn:www.agenziaentrate.gov.it:specificheTecniche:sco:730	
type	<a href="#">DatoNP_Type</a>	
facets	Kind	Value
	pattern	[1-9]{1}[0-9]*

#### element **Crediti\_F24\_Type/CredImpostaSostDipNoSostituto**

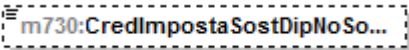
diagram		
namespace	urn:www.agenziaentrate.gov.it:specificheTecniche:sco:730	
type	<a href="#">DatoNP_Type</a>	
facets	Kind	Value
	pattern	[1-9]{1}[0-9]*

#### element **Crediti\_F24\_Type/Totale**

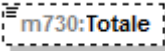
diagram		
namespace	urn:www.agenziaentrate.gov.it:specificheTecniche:sco:730	
type	<a href="#">DatoNP_Type</a>	
facets	Kind	Value
	pattern	[1-9]{1}[0-9]*

#### element **Crediti\_F24\_Type/TotaleDipNoSostituto**

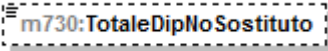
diagram		
namespace	urn:www.agenziaentrate.gov.it:specificheTecniche:sco:730	
type	<a href="#">DatoNP_Type</a>	
facets	Kind	Value
	pattern	[1-9]{1}[0-9]*

complexType **Crediti\_Imposta\_Altri\_Sisma\_Abruzzo\_Type**

diagram	
namespace	urn:www.agenziaentrate.gov.it:specificheTecniche:sco:730
children	<a href="#">m730:Impresa_Professione</a> <a href="#">m730:CreditoImmobileSismaAbruzzo</a> <a href="#">m730:Rateazione</a>

element **Crediti\_Imposta\_Altri\_Sisma\_Abruzzo\_Type/Impresa\_Professione**

diagram					
namespace	urn:www.agenziaentrate.gov.it:specificheTecniche:sco:730				
type	<a href="#">DatoCB_Type</a>				
facets	<table border="1"> <tr> <th>Kind</th> <th>Value</th> </tr> <tr> <td>pattern</td> <td>[01]</td> </tr> </table>	Kind	Value	pattern	[01]
Kind	Value				
pattern	[01]				

element **Crediti\_Imposta\_Altri\_Sisma\_Abruzzo\_Type/CreditoImmobileSismaAbruzzo**

diagram	
namespace	urn:www.agenziaentrate.gov.it:specificheTecniche:sco:730
type	<a href="#">m730:Credito_Immibile_Sisma_Abruzzo_Type</a>
children	<a href="#">m730:CodiceFiscale</a> <a href="#">m730:NumeroRata</a> <a href="#">m730:TotaleCredito</a>

element **Crediti\_Imposta\_Altri\_Sisma\_Abruzzo\_Type/Rateazione**

diagram									
namespace	urn:www.agenziaentrate.gov.it:specificheTecniche:sco:730								
type	restriction of <a href="#">DatoNP_Type</a>								
facets	<table border="1"> <tr> <th>Kind</th> <th>Value</th> </tr> <tr> <td>pattern</td> <td>[1-9]{1}[0-9]*</td> </tr> <tr> <td>enumeration</td> <td>5</td> </tr> <tr> <td>enumeration</td> <td>10</td> </tr> </table>	Kind	Value	pattern	[1-9]{1}[0-9]*	enumeration	5	enumeration	10
Kind	Value								
pattern	[1-9]{1}[0-9]*								
enumeration	5								
enumeration	10								

complexType **Crediti\_Imposta\_Fabbricati\_Type**

diagram	
namespace	urn:www.agenziaentrate.gov.it:specificheTecniche:sco:730
children	<a href="#">m730:ResiduoFabbricati</a> <a href="#">m730:CanoniLocazioneNonPercepiti</a>

element **Crediti\_Imposta\_Fabbricati\_Type/ResiduoFabbricati**

diagram	
namespace	urn:www.agenziaentrate.gov.it:specificheTecniche:sco:730
type	<a href="#">m730:Residuo_Fabbricati_Type</a>
children	<a href="#">m730:ResiduoPrecedenteDichiarazione</a> <a href="#">m730:CreditoAnno</a> <a href="#">m730:DiCuiCompensatoF24</a>

element **Crediti\_Imposta\_Fabbricati\_Type/CanoniLocazioneNonPercepiti**

diagram					
namespace	urn:www.agenziaentrate.gov.it:specificheTecniche:sco:730				
type	<a href="#">DatoNP_Type</a>				
facets	<table border="1"> <thead> <tr> <th>Kind</th> <th>Value</th> </tr> </thead> <tbody> <tr> <td>pattern</td> <td>[1-9]{1}[0-9]*</td> </tr> </tbody> </table>	Kind	Value	pattern	[1-9]{1}[0-9]*
Kind	Value				
pattern	[1-9]{1}[0-9]*				

complexType **Crediti\_Imposta\_Fondi\_Pensione\_Type**

diagram	
namespace	urn:www.agenziaentrate.gov.it:specificheTecniche:sco:730

children	<a href="#">m730:AnnoAnticipazione</a> <a href="#">m730:Reintegro</a> <a href="#">m730:SommaReintegrata</a> <a href="#">m730:CreditoAnno</a>
----------	--

element **Crediti\_Imposta\_Fondi\_Pensione\_Type/AnnoAnticipazione**

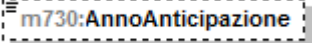
diagram																											
namespace	urn:www.agenziaentrate.gov.it:specificheTecniche:sco:730																										
type	<a href="#">m730:Anno Anticipazione Fondo Pensione Type</a>																										
facets	<table border="1"> <thead> <tr> <th>Kind</th> <th>Value</th> </tr> </thead> <tbody> <tr> <td>pattern</td> <td>[1-9]{1}[0-9]*</td> </tr> <tr> <td>enumeration</td> <td>2007</td> </tr> <tr> <td>enumeration</td> <td>2008</td> </tr> <tr> <td>enumeration</td> <td>2009</td> </tr> <tr> <td>enumeration</td> <td>2010</td> </tr> <tr> <td>enumeration</td> <td>2011</td> </tr> <tr> <td>enumeration</td> <td>2012</td> </tr> <tr> <td>enumeration</td> <td>2013</td> </tr> <tr> <td>enumeration</td> <td>2014</td> </tr> <tr> <td>enumeration</td> <td>2015</td> </tr> <tr> <td>enumeration</td> <td>2016</td> </tr> <tr> <td>enumeration</td> <td>2017</td> </tr> </tbody> </table>	Kind	Value	pattern	[1-9]{1}[0-9]*	enumeration	2007	enumeration	2008	enumeration	2009	enumeration	2010	enumeration	2011	enumeration	2012	enumeration	2013	enumeration	2014	enumeration	2015	enumeration	2016	enumeration	2017
Kind	Value																										
pattern	[1-9]{1}[0-9]*																										
enumeration	2007																										
enumeration	2008																										
enumeration	2009																										
enumeration	2010																										
enumeration	2011																										
enumeration	2012																										
enumeration	2013																										
enumeration	2014																										
enumeration	2015																										
enumeration	2016																										
enumeration	2017																										

element **Crediti\_Imposta\_Fondi\_Pensione\_Type/Reintegro**

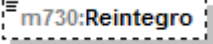
diagram									
namespace	urn:www.agenziaentrate.gov.it:specificheTecniche:sco:730								
type	<a href="#">m730:Reintegro Totale Parziale Type</a>								
facets	<table border="1"> <thead> <tr> <th>Kind</th> <th>Value</th> </tr> </thead> <tbody> <tr> <td>pattern</td> <td>[1-9]</td> </tr> <tr> <td>enumeration</td> <td>1</td> </tr> <tr> <td>enumeration</td> <td>2</td> </tr> </tbody> </table>	Kind	Value	pattern	[1-9]	enumeration	1	enumeration	2
Kind	Value								
pattern	[1-9]								
enumeration	1								
enumeration	2								

element **Crediti\_Imposta\_Fondi\_Pensione\_Type/SommaReintegrata**

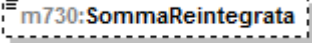
diagram					
namespace	urn:www.agenziaentrate.gov.it:specificheTecniche:sco:730				
type	<a href="#">DatoNP Type</a>				
facets	<table border="1"> <thead> <tr> <th>Kind</th> <th>Value</th> </tr> </thead> <tbody> <tr> <td>pattern</td> <td>[1-9]{1}[0-9]*</td> </tr> </tbody> </table>	Kind	Value	pattern	[1-9]{1}[0-9]*
Kind	Value				
pattern	[1-9]{1}[0-9]*				

element **Crediti\_Imposta\_Fondi\_Pensione\_Type/CreditoAnno**

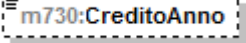
diagram	
namespace	urn:www.agenziaentrate.gov.it:specificheTecniche:sco:730
type	<a href="#">DatoNP Type</a>

facets	Kind pattern	Value [1-9]{1}[0-9]*
--------	-----------------	-------------------------

### complexType **Crediti\_Imposta\_Reddit\_Esteri\_Type**

diagram	
namespace	urn:www.agenziaentrate.gov.it:specificheTecniche:sco:730
children	<a href="#">m730:StatoEstero</a> <a href="#">m730:Anno</a> <a href="#">m730:RedditoEstero</a> <a href="#">m730:ImpostaEstera</a> <a href="#">m730:RedditoComplessivo</a> <a href="#">m730:Imposta_Lorda</a> <a href="#">m730:ImpostaNetta</a> <a href="#">m730:CreditoDichiarazioniPrecedenti</a> <a href="#">m730:DiCuiStatoEstero</a>

### element **Crediti\_Imposta\_Reddit\_Esteri\_Type/StatoEstero**

diagram	
namespace	urn:www.agenziaentrate.gov.it:specificheTecniche:sco:730
type	<a href="#">DatoAN_Type</a>
facets	Kind Value pattern ([0-9A-Z\-\_]&quot;){1}([ 0-9A-Z&amp;:] ' \- \., / ^ \^\( \) À É Ì Ò Ù Û &quot; \ \\ +)*

### element **Crediti\_Imposta\_Reddit\_Esteri\_Type/Anno**

diagram	
namespace	urn:www.agenziaentrate.gov.it:specificheTecniche:sco:730
type	restriction of <a href="#">DatoDA_Type</a>
facets	Kind Value pattern (18 19 20)[0-9]{2}

element **Crediti\_Imposta\_Redditi\_Esteri\_Type/RedditoEstero**

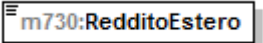
diagram	
namespace	urn:www.agenziaentrate.gov.it:specificheTecniche:sco:730
type	<a href="#">DatoNP_Type</a>
facets	Kind Value pattern [1-9]{1}[0-9]*

element **Crediti\_Imposta\_Redditi\_Esteri\_Type/ImpostaEstera**

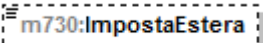
diagram	
namespace	urn:www.agenziaentrate.gov.it:specificheTecniche:sco:730
type	<a href="#">DatoNP_Type</a>
facets	Kind Value pattern [1-9]{1}[0-9]*

element **Crediti\_Imposta\_Redditi\_Esteri\_Type/RedditoComplessivo**

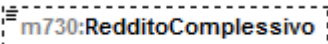
diagram	
namespace	urn:www.agenziaentrate.gov.it:specificheTecniche:sco:730
type	<a href="#">DatoNP_Type</a>
facets	Kind Value pattern [1-9]{1}[0-9]*

element **Crediti\_Imposta\_Redditi\_Esteri\_Type/Imposta\_Lorda**

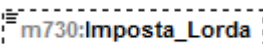
diagram	
namespace	urn:www.agenziaentrate.gov.it:specificheTecniche:sco:730
type	<a href="#">DatoNP_Type</a>
facets	Kind Value pattern [1-9]{1}[0-9]*

element **Crediti\_Imposta\_Redditi\_Esteri\_Type/ImpostaNetta**

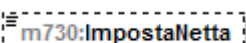
diagram	
namespace	urn:www.agenziaentrate.gov.it:specificheTecniche:sco:730
type	<a href="#">DatoNP_Type</a>
facets	Kind Value pattern [1-9]{1}[0-9]*

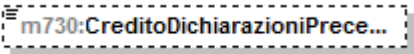

element **Crediti\_Imposta\_Redditi\_Esteri\_Type/CreditoDichiarazioniPrecedenti**

diagram	
namespace	urn:www.agenziaentrate.gov.it:specificheTecniche:sco:730
type	<a href="#">DatoNP_Type</a>
facets	Kind Value pattern [1-9]{1}[0-9]*

element **Crediti\_Imposta\_Redditi\_Esteri\_Type/DiCuiStatoEstero**

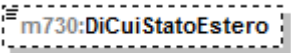
diagram	
namespace	urn:www.agenziaentrate.gov.it:specificheTecniche:sco:730
type	<a href="#">DatoNP_Type</a>
facets	Kind Value pattern [1-9]{1}[0-9]*

complexType **Crediti\_Imposta\_Type**

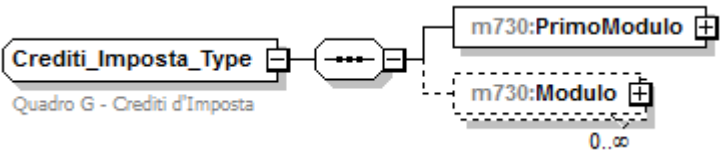
diagram	
namespace	urn:www.agenziaentrate.gov.it:specificheTecniche:sco:730
children	<a href="#">m730:PrimoModulo</a> <a href="#">m730:Modulo</a>

element **Crediti\_Imposta\_Type/PrimoModulo**

<p>diagram</p>	
<p>namespace</p>	<p>urn:www.agenziaentrate.gov.it:specificheTecniche:sco:730</p>
<p>type</p>	<p><a href="#">m730:Primo_Modulo_Crediti_Imposta_Type</a></p>
<p>children</p>	<p><a href="#">m730:CreditoImpostaFabbricati</a> <a href="#">m730:CreditoImpostaFondiPensione</a> <a href="#">m730:CreditoImpostaRedditiEsteri</a> <a href="#">m730:CreditoPrimaCasaSismaAbruzzo</a> <a href="#">m730:CreditoAltriSismaAbruzzo</a> <a href="#">m730:CreditoIncrementoOccupazione</a> <a href="#">m730:CreditoImpostaMediazioni</a> <a href="#">m730:CreditoErogazioniCultura</a> <a href="#">m730:CreditoNegoziazione</a> <a href="#">m730:CreditoErogazioniScuola</a> <a href="#">m730:CreditoVideosorveglianza</a></p>

element **Crediti\_Imposta\_Type/Modulo**

<p>diagram</p>	
<p>namespace</p>	<p>urn:www.agenziaentrate.gov.it:specificheTecniche:sco:730</p>

type	<a href="#">m730:Modulo_Crediti_Imposta_Type</a>
children	<a href="#">m730:CreditoImpostaFondiPensione</a> <a href="#">m730:CreditoImpostaRedditiEsteri</a> <a href="#">m730:CreditoPrimaCasaSismaAbruzzo</a> <a href="#">m730:CreditoAltriSismaAbruzzo</a> <a href="#">m730:CreditoNegoziazione</a>

### complexType **Credito\_Erogazioni\_Cultura\_Type**

diagram	
namespace	urn:www.agenziaentrate.gov.it:specificheTecniche:sco:730
children	<a href="#">m730:SpesaAnno</a> <a href="#">m730:ResiduoAnnoPrec</a> <a href="#">m730:RataAnnoPrec</a> <a href="#">m730:RataDueAnniPrec</a>

### element **Credito\_Erogazioni\_Cultura\_Type/SpesaAnno**

diagram					
namespace	urn:www.agenziaentrate.gov.it:specificheTecniche:sco:730				
type	<a href="#">DatoNP_Type</a>				
facets	<table border="1"> <tr> <td>Kind</td> <td>Value</td> </tr> <tr> <td>pattern</td> <td>[1-9]{1}[0-9]*</td> </tr> </table>	Kind	Value	pattern	[1-9]{1}[0-9]*
Kind	Value				
pattern	[1-9]{1}[0-9]*				

### element **Credito\_Erogazioni\_Cultura\_Type/ResiduoAnnoPrec**

diagram					
namespace	urn:www.agenziaentrate.gov.it:specificheTecniche:sco:730				
type	<a href="#">DatoNP_Type</a>				
facets	<table border="1"> <tr> <td>Kind</td> <td>Value</td> </tr> <tr> <td>pattern</td> <td>[1-9]{1}[0-9]*</td> </tr> </table>	Kind	Value	pattern	[1-9]{1}[0-9]*
Kind	Value				
pattern	[1-9]{1}[0-9]*				

### element **Credito\_Erogazioni\_Cultura\_Type/RataAnnoPrec**

diagram					
namespace	urn:www.agenziaentrate.gov.it:specificheTecniche:sco:730				
type	<a href="#">DatoNP_Type</a>				
facets	<table border="1"> <tr> <td>Kind</td> <td>Value</td> </tr> <tr> <td>pattern</td> <td>[1-9]{1}[0-9]*</td> </tr> </table>	Kind	Value	pattern	[1-9]{1}[0-9]*
Kind	Value				
pattern	[1-9]{1}[0-9]*				

element **Credito\_Erogazioni\_Cultura\_Type/RataDueAnniPrec**

diagram	
namespace	urn:www.agenziaentrate.gov.it:specificheTecniche:sco:730
type	<a href="#">DatoNP_Type</a>
facets	Kind Value pattern [1-9]{1}[0-9]*

complexType **Credito\_Erogazioni\_Scuola\_Type**

diagram	
namespace	urn:www.agenziaentrate.gov.it:specificheTecniche:sco:730
children	<a href="#">m730:SpesaAnno</a> <a href="#">m730:SpesaAnnoPrec</a> <a href="#">m730:ResiduoAnnoPrec</a>

element **Credito\_Erogazioni\_Scuola\_Type/SpesaAnno**

diagram	
namespace	urn:www.agenziaentrate.gov.it:specificheTecniche:sco:730
type	<a href="#">DatoNP_Type</a>
facets	Kind Value pattern [1-9]{1}[0-9]*

element **Credito\_Erogazioni\_Scuola\_Type/SpesaAnnoPrec**

diagram	
namespace	urn:www.agenziaentrate.gov.it:specificheTecniche:sco:730
type	<a href="#">DatoNP_Type</a>
facets	Kind Value pattern [1-9]{1}[0-9]*

element **Credito\_Erogazioni\_Scuola\_Type/ResiduoAnnoPrec**

diagram	
namespace	urn:www.agenziaentrate.gov.it:specificheTecniche:sco:730

type	<a href="#">DatoNP_Type</a>
facets	Kind Value pattern [1-9]{1}[0-9]*

### complexType Credito\_Immobile\_Sisma\_Abruzzo\_Type

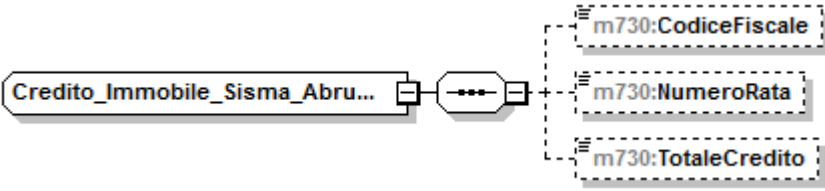
diagram	
namespace	urn:www.agenziaentrate.gov.it:specificheTecniche:sco:730
children	<a href="#">m730:CodiceFiscale</a> <a href="#">m730:NumeroRata</a> <a href="#">m730:TotaleCredito</a>

### element Credito\_Immobile\_Sisma\_Abruzzo\_Type/CodiceFiscale

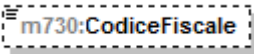
diagram	
namespace	urn:www.agenziaentrate.gov.it:specificheTecniche:sco:730
type	<a href="#">DatoCF_Type</a>
facets	Kind Value pattern [0-9]{11}[A-Z]{6}[0-9LMNPQRSTU]{2}[A-Z]{1}[0-9LMNPQRSTU]{2}[A-Z]{1}[0-9LMNPQRSTU]{3}[A-Z]{1}

### element Credito\_Immobile\_Sisma\_Abruzzo\_Type/NumeroRata

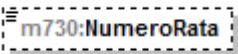
diagram	
namespace	urn:www.agenziaentrate.gov.it:specificheTecniche:sco:730
type	restriction of <a href="#">DatoNP_Type</a>
facets	Kind Value pattern [1-9]{1}[0-9]* enumeration 1 enumeration 2 enumeration 3 enumeration 4 enumeration 5 enumeration 6 enumeration 7 enumeration 8 enumeration 9

### element Credito\_Immobile\_Sisma\_Abruzzo\_Type/TotaleCredito

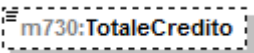
diagram	
namespace	urn:www.agenziaentrate.gov.it:specificheTecniche:sco:730

type	<a href="#">DatoNP_Type</a>
facets	Kind Value pattern [1-9]{1}[0-9]*

#### complexType **Credito\_Incremento\_Occupazione\_Type**

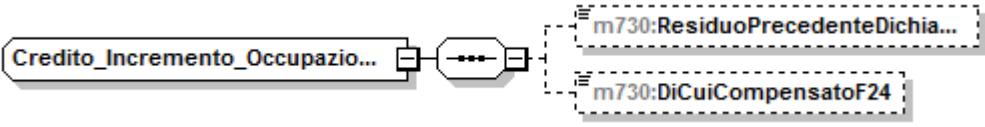
diagram	
namespace	urn:www.agenziaentrate.gov.it:specificheTecniche:sco:730
children	<a href="#">m730:ResiduoPrecedenteDichiarazione</a> <a href="#">m730:DiCuiCompensatoF24</a>

#### element **Credito\_Incremento\_Occupazione\_Type/ResiduoPrecedenteDichiarazione**

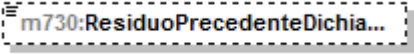
diagram	
namespace	urn:www.agenziaentrate.gov.it:specificheTecniche:sco:730
type	<a href="#">DatoNP_Type</a>
facets	Kind Value pattern [1-9]{1}[0-9]*

#### element **Credito\_Incremento\_Occupazione\_Type/DiCuiCompensatoF24**

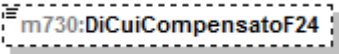
diagram	
namespace	urn:www.agenziaentrate.gov.it:specificheTecniche:sco:730
type	<a href="#">DatoNP_Type</a>
facets	Kind Value pattern [1-9]{1}[0-9]*

#### complexType **Credito\_Negoziatore\_Type**

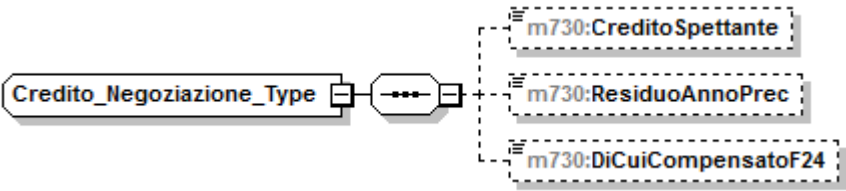
diagram	
namespace	urn:www.agenziaentrate.gov.it:specificheTecniche:sco:730
children	<a href="#">m730:CreditoSpettante</a> <a href="#">m730:ResiduoAnnoPrec</a> <a href="#">m730:DiCuiCompensatoF24</a>

element **Credito\_Negoziatore\_Type/CreditoSpettante**

diagram	
namespace	urn:www.agenziaentrate.gov.it:specificheTecniche:sco:730
type	<a href="#">DatoNP_Type</a>
facets	Kind Value pattern [1-9]{1}[0-9]*

element **Credito\_Negoziatore\_Type/ResiduoAnnoPrec**

diagram	
namespace	urn:www.agenziaentrate.gov.it:specificheTecniche:sco:730
type	<a href="#">DatoNP_Type</a>
facets	Kind Value pattern [1-9]{1}[0-9]*

element **Credito\_Negoziatore\_Type/DiCuiCompensatoF24**

diagram	
namespace	urn:www.agenziaentrate.gov.it:specificheTecniche:sco:730
type	<a href="#">DatoNP_Type</a>
facets	Kind Value pattern [1-9]{1}[0-9]*

complexType **Credito\_Stato\_Type**

diagram	
namespace	urn:www.agenziaentrate.gov.it:specificheTecniche:sco:730
children	<a href="#">m730:Stato</a> <a href="#">m730:Credito</a>

element **Credito\_Stato\_Type/Stato**

diagram	
namespace	urn:www.agenziaentrate.gov.it:specificheTecniche:sco:730
type	<a href="#">DatoAN_Type</a>
facets	Kind Value pattern ([0-9A-Z- &quot;){1}([0-9A-Z&amp;] ' \" . / ° \"\\( \\) À É È Ì Ò Ù Û &quot; \\ \\ \\+)*

**element Credito\_Stato\_Type/Credito**

diagram					
namespace	urn:www.agenziaentrate.gov.it:specificheTecniche:sco:730				
type	<a href="#">DatoNP_Type</a>				
facets	<table border="1"> <tr> <td>Kind</td> <td>Value</td> </tr> <tr> <td>pattern</td> <td>[1-9]{1}[0-9]*</td> </tr> </table>	Kind	Value	pattern	[1-9]{1}[0-9]*
Kind	Value				
pattern	[1-9]{1}[0-9]*				

**complexType Credito\_Type**

diagram	
namespace	urn:www.agenziaentrate.gov.it:specificheTecniche:sco:730
children	<a href="#">m730:NonRimborsabile</a> <a href="#">m730:Credito</a> <a href="#">m730:CreditoF24</a> <a href="#">m730:CreditoRimborso</a>

**element Credito\_Type/NonRimborsabile**

diagram					
namespace	urn:www.agenziaentrate.gov.it:specificheTecniche:sco:730				
type	<a href="#">DatoNP_Type</a>				
facets	<table border="1"> <tr> <td>Kind</td> <td>Value</td> </tr> <tr> <td>pattern</td> <td>[1-9]{1}[0-9]*</td> </tr> </table>	Kind	Value	pattern	[1-9]{1}[0-9]*
Kind	Value				
pattern	[1-9]{1}[0-9]*				

**element Credito\_Type/Credito**

diagram					
namespace	urn:www.agenziaentrate.gov.it:specificheTecniche:sco:730				
type	<a href="#">DatoNP_Type</a>				
facets	<table border="1"> <tr> <td>Kind</td> <td>Value</td> </tr> <tr> <td>pattern</td> <td>[1-9]{1}[0-9]*</td> </tr> </table>	Kind	Value	pattern	[1-9]{1}[0-9]*
Kind	Value				
pattern	[1-9]{1}[0-9]*				

**element Credito\_Type/CreditoF24**

diagram	
---------	--



namespace	urn:www.agenziaentrate.gov.it:specificheTecniche:sco:730
type	<a href="#">DatoNP_Type</a>
facets	Kind Value pattern [1-9]{1}[0-9]*

#### element **Credito\_Type/CreditoRimborso**

diagram	
namespace	urn:www.agenziaentrate.gov.it:specificheTecniche:sco:730
type	<a href="#">DatoNP_Type</a>
facets	Kind Value pattern [1-9]{1}[0-9]*

#### complexType **Credito\_Videosorveglianza\_Type**

diagram	
namespace	urn:www.agenziaentrate.gov.it:specificheTecniche:sco:730
children	<a href="#">m730:ResiduoAnnoPrec</a> <a href="#">m730:DiCuiCompensatoF24</a>

#### element **Credito\_Videosorveglianza\_Type/ResiduoAnnoPrec**

diagram	
namespace	urn:www.agenziaentrate.gov.it:specificheTecniche:sco:730
type	<a href="#">DatoNP_Type</a>
facets	Kind Value pattern [1-9]{1}[0-9]*

#### element **Credito\_Videosorveglianza\_Type/DiCuiCompensatoF24**

diagram	
namespace	urn:www.agenziaentrate.gov.it:specificheTecniche:sco:730
type	<a href="#">DatoNP_Type</a>
facets	Kind Value pattern [1-9]{1}[0-9]*

complexType **Dati\_730\_Integrativo\_Type**

diagram	
namespace	urn:www.agenziaentrate.gov.it:specificheTecniche:sco:730
children	<a href="#">m730:Rimborso</a> <a href="#">m730:Credito</a>

element **Dati\_730\_Integrativo\_Type/Rimborso**

diagram	
namespace	urn:www.agenziaentrate.gov.it:specificheTecniche:sco:730
type	<a href="#">m730:Elemento_Integrativo_Type</a>
children	<a href="#">m730:Irpef</a> <a href="#">m730:AddizionaleRegionaleIrpef</a> <a href="#">m730:AddComunaleIrpef</a> <a href="#">m730:CedolareSecca</a>

element **Dati\_730\_Integrativo\_Type/Credito**

diagram	
namespace	urn:www.agenziaentrate.gov.it:specificheTecniche:sco:730
type	<a href="#">m730:Elemento_Integrativo_Type</a>
children	<a href="#">m730:Irpef</a> <a href="#">m730:AddizionaleRegionaleIrpef</a> <a href="#">m730:AddComunaleIrpef</a> <a href="#">m730:CedolareSecca</a>

complexType **Dati\_Altr\_e\_Detra\_zioni\_Modulo\_Type**

diagram	
namespace	urn:www.agenziaentrate.gov.it:specificheTecniche:sco:730
children	<a href="#">m730:Altr_e_Detra_zioni</a>

element **Dati\_Altr\_e\_Detra\_zioni\_Modulo\_Type/Altr\_e\_Detra\_zioni**

diagram	
namespace	urn:www.agenziaentrate.gov.it:specificheTecniche:sco:730
type	<a href="#">m730:Altr_e_Detra_zioni_Type</a>
children	<a href="#">m730:Codice</a> <a href="#">m730:Importo</a>

complexType **Dati\_Altr\_e\_Detra\_zioni\_Type**

diagram	
namespace	urn:www.agenziaentrate.gov.it:specificheTecniche:sco:730
children	<a href="#">m730:SpeseCaniGuida</a> <a href="#">m730:AffittoTerreniAgricoliGiovani</a> <a href="#">m730:Altr_e_Detra_zioni</a>

element **Dati\_Altr\_e\_Detra\_zioni\_Type/SpeseCaniGuida**

diagram					
namespace	urn:www.agenziaentrate.gov.it:specificheTecniche:sco:730				
type	<a href="#">DatoCB_Type</a>				
facets	<table border="1"> <thead> <tr> <th>Kind</th> <th>Value</th> </tr> </thead> <tbody> <tr> <td>pattern</td> <td>[01]</td> </tr> </tbody> </table>	Kind	Value	pattern	[01]
Kind	Value				
pattern	[01]				

element **Dati\_Altr\_e\_Detra\_zioni\_Type/AffittoTerreniAgricoliGiovani**

diagram	
---------	--

namespace	urn:www.agenziaentrate.gov.it:specificheTecniche:sco:730	
type	<a href="#">DatoNP_Type</a>	
facets	Kind	Value
	pattern	[1-9]{1}[0-9]*

**element Dati\_Altre\_Detrazioni\_Type/AltreDetrazioni**

diagram		
namespace	urn:www.agenziaentrate.gov.it:specificheTecniche:sco:730	
type	<a href="#">m730:Altre_Detrazioni_Type</a>	
children	<a href="#">m730:Codice</a> <a href="#">m730:Importo</a>	

**complexType Dati\_Associazioni\_Professionale\_Type**

diagram		
namespace	urn:www.agenziaentrate.gov.it:specificheTecniche:sco:730	
children	<a href="#">m730:CFAssociazione</a> <a href="#">m730:DenominazioneAssociazione</a> <a href="#">m730:CFProfessionista</a> <a href="#">m730:CognomeProfessionista</a> <a href="#">m730:NomeProfessionista</a>	

**element Dati\_Associazioni\_Professionale\_Type/CFAssociazione**

diagram		
namespace	urn:www.agenziaentrate.gov.it:specificheTecniche:sco:730	
type	<a href="#">DatoCN_Type</a>	
facets	Kind	Value
	pattern	[0-9]{11}

element **Dati\_Associazioni\_Professionale\_Type/DenominazioneAssociazione**

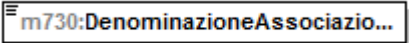
diagram	
namespace	urn:www.agenziaentrate.gov.it:specificheTecniche:sco:730
type	<a href="#">DatoAN_Type</a>
facets	Kind Value pattern (([0-9A-Z-]*)&quot;){1}([ 0-9A-Z&amp;:] ' \"- \\. / ° \\^\\(\\ )À È É Ì Ò Ù Û &quot; \\ \\ \\ +)*

element **Dati\_Associazioni\_Professionale\_Type/CFProfessionista**

diagram	
namespace	urn:www.agenziaentrate.gov.it:specificheTecniche:sco:730
type	<a href="#">DatoCF_Type</a>
facets	Kind Value pattern [0-9]{11}[A-Z]{6}[0-9LMNPQRSTU]{2}[A-Z]{1}[0-9LMNPQRSTU]{2}[A-Z]{1}[0-9LMNPQRSTU]{3}[A-Z]{1}

element **Dati\_Associazioni\_Professionale\_Type/CognomeProfessionista**

diagram	
namespace	urn:www.agenziaentrate.gov.it:specificheTecniche:sco:730
type	<a href="#">DatoAN_Type</a>
facets	Kind Value pattern (([0-9A-Z-]*)&quot;){1}([ 0-9A-Z&amp;:] ' \"- \\. / ° \\^\\(\\ )À È É Ì Ò Ù Û &quot; \\ \\ \\ +)*

element **Dati\_Associazioni\_Professionale\_Type/NomeProfessionista**

diagram	
namespace	urn:www.agenziaentrate.gov.it:specificheTecniche:sco:730
type	<a href="#">DatoAN_Type</a>
facets	Kind Value pattern (([0-9A-Z-]*)&quot;){1}([ 0-9A-Z&amp;:] ' \"- \\. / ° \\^\\(\\ )À È É Ì Ò Ù Û &quot; \\ \\ \\ +)*

complexType **Dati\_CAF\_Type**

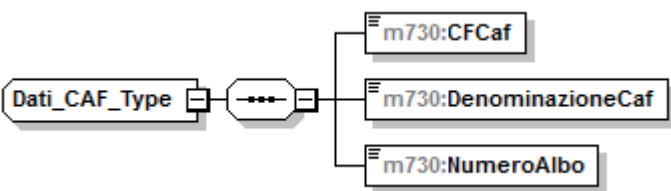
diagram	
namespace	urn:www.agenziaentrate.gov.it:specificheTecniche:sco:730

children	<a href="#">m730:CFCaf</a> <a href="#">m730:DenominazioneCaf</a> <a href="#">m730:NumeroAlbo</a>
----------	--

#### element **Dati\_CAF\_Type/CFCaf**

diagram	
namespace	urn:www.agenziaentrate.gov.it:specificheTecniche:sco:730
type	<a href="#">DatoCN_Type</a>
facets	Kind Value pattern [0-9]{11}

#### element **Dati\_CAF\_Type/DenominazioneCaf**

diagram	
namespace	urn:www.agenziaentrate.gov.it:specificheTecniche:sco:730
type	<a href="#">DatoAN_Type</a>
facets	Kind Value pattern (([0-9A-Z-] \&quot;){1})([ 0-9A-Z&amp;:] ' \- \., / ° ^\(\ )\ À È É Ì Ò Ù Ü &quot; \ \\ \ +)*

#### element **Dati\_CAF\_Type/NumeroAlbo**

diagram	
namespace	urn:www.agenziaentrate.gov.it:specificheTecniche:sco:730
type	restriction of <a href="#">DatoNP_Type</a>
facets	Kind Value pattern [1-9]{1}[0-9]*

#### complexType **Dati\_Catastali\_Recupero\_Patrimonio\_Edilizio\_Type**

diagram	
namespace	urn:www.agenziaentrate.gov.it:specificheTecniche:sco:730
children	<a href="#">m730:NOrdImmobile</a> <a href="#">m730:Condominio</a> <a href="#">m730:DatiCatastali</a>

element **Dati\_Catastali\_Recupero\_Patrimonio\_Edilizio\_Type/NOrdImmobile**

diagram	
namespace	urn:www.agenziaentrate.gov.it:specificheTecniche:sco:730
type	<a href="#">DatoNP_Type</a>
facets	Kind Value pattern [1-9]{1}[0-9]*

element **Dati\_Catastali\_Recupero\_Patrimonio\_Edilizio\_Type/Condominio**

diagram	
namespace	urn:www.agenziaentrate.gov.it:specificheTecniche:sco:730
type	<a href="#">DatoCB_Type</a>
facets	Kind Value pattern [01]

element **Dati\_Catastali\_Recupero\_Patrimonio\_Edilizio\_Type/DatiCatastali**

diagram	
namespace	urn:www.agenziaentrate.gov.it:specificheTecniche:sco:730
type	<a href="#">m730:Dati_Catastali_Type</a>
children	<a href="#">m730:CodiceComune</a> <a href="#">m730:TerreniUrbano</a> <a href="#">m730:SezioneUrbanaComuneCatastale</a> <a href="#">m730:Foglio</a> <a href="#">m730:Particella</a> <a href="#">m730:Subalterno</a>

### complexType Dati\_Catastali\_Type

diagram	
namespace	urn:www.agenziaentrate.gov.it:specificheTecniche:sco:730
children	<a href="#">m730:CodiceComune</a> <a href="#">m730:TerreniUrbano</a> <a href="#">m730:SezioneUrbanaComuneCatastale</a> <a href="#">m730:Foglio</a> <a href="#">m730:Particella</a> <a href="#">m730:Subalterno</a>

### element Dati\_Catastali\_Type/CodiceComune

diagram					
namespace	urn:www.agenziaentrate.gov.it:specificheTecniche:sco:730				
type	<a href="#">DatoAN_Type</a>				
facets	<table border="0"> <tr> <td>Kind</td> <td>Value</td> </tr> <tr> <td>pattern</td> <td>(([0-9A-Z\-\]]&amp;quot;){1}([ 0-9A-Z&amp;amp;]] \- \., / ^ \^\(\\ )\) À È É Ì Ò Ù Ü &amp;quot; \ \\ \ +)*</td> </tr> </table>	Kind	Value	pattern	(([0-9A-Z\-\]]&quot;){1}([ 0-9A-Z&amp;]] \- \., / ^ \^\(\\ )\) À È É Ì Ò Ù Ü &quot; \ \\ \ +)*
Kind	Value				
pattern	(([0-9A-Z\-\]]&quot;){1}([ 0-9A-Z&amp;]] \- \., / ^ \^\(\\ )\) À È É Ì Ò Ù Ü &quot; \ \\ \ +)*				

### element Dati\_Catastali\_Type/TerreniUrbano

diagram									
namespace	urn:www.agenziaentrate.gov.it:specificheTecniche:sco:730								
type	<a href="#">m730:Terreni Urbano_Type</a>								
facets	<table border="0"> <tr> <td>Kind</td> <td>Value</td> </tr> <tr> <td>pattern</td> <td>(([0-9A-Z\-\]]&amp;quot;){1}([ 0-9A-Z&amp;amp;]] \- \., / ^ \^\(\\ )\) À È É Ì Ò Ù Ü &amp;quot; \ \\ \ +)*</td> </tr> <tr> <td>enumeration</td> <td>T</td> </tr> <tr> <td>enumeration</td> <td>U</td> </tr> </table>	Kind	Value	pattern	(([0-9A-Z\-\]]&quot;){1}([ 0-9A-Z&amp;]] \- \., / ^ \^\(\\ )\) À È É Ì Ò Ù Ü &quot; \ \\ \ +)*	enumeration	T	enumeration	U
Kind	Value								
pattern	(([0-9A-Z\-\]]&quot;){1}([ 0-9A-Z&amp;]] \- \., / ^ \^\(\\ )\) À È É Ì Ò Ù Ü &quot; \ \\ \ +)*								
enumeration	T								
enumeration	U								

### element Dati\_Catastali\_Type/SezioneUrbanaComuneCatastale

diagram					
namespace	urn:www.agenziaentrate.gov.it:specificheTecniche:sco:730				
type	<a href="#">DatoAN_Type</a>				
facets	<table border="0"> <tr> <td>Kind</td> <td>Value</td> </tr> <tr> <td>pattern</td> <td>(([0-9A-Z\-\]]&amp;quot;){1}([ 0-9A-Z&amp;amp;]] \- \., / ^ \^\(\\ )\) À È É Ì Ò Ù Ü &amp;quot; \ \\ \ +)*</td> </tr> </table>	Kind	Value	pattern	(([0-9A-Z\-\]]&quot;){1}([ 0-9A-Z&amp;]] \- \., / ^ \^\(\\ )\) À È É Ì Ò Ù Ü &quot; \ \\ \ +)*
Kind	Value				
pattern	(([0-9A-Z\-\]]&quot;){1}([ 0-9A-Z&amp;]] \- \., / ^ \^\(\\ )\) À È É Ì Ò Ù Ü &quot; \ \\ \ +)*				



element **Dati\_Catastali\_Type/Foglio**

diagram	
namespace	urn:www.agenziaentrate.gov.it:specificheTecniche:sco:730
type	<a href="#">DatoAN_Type</a>
facets	Kind Value pattern ([0-9A-Z\-\] \&quot;){1}([ 0-9A-Z&amp;] '\-\-\ , /'^\(\ \) À É È Ì Ò Ù Û \&quot; \ \ \ +)*

element **Dati\_Catastali\_Type/Particella**

diagram	
namespace	urn:www.agenziaentrate.gov.it:specificheTecniche:sco:730
children	<a href="#">m730:Numeratore</a> <a href="#">m730:Denominatore</a>

element **Dati\_Catastali\_Type/Particella/Numeratore**

diagram	
namespace	urn:www.agenziaentrate.gov.it:specificheTecniche:sco:730
type	<a href="#">DatoAN_Type</a>
facets	Kind Value pattern ([0-9A-Z\-\] \&quot;){1}([ 0-9A-Z&amp;] '\-\-\ , /'^\(\ \) À É È Ì Ò Ù Û \&quot; \ \ \ +)*

element **Dati\_Catastali\_Type/Particella/Denominatore**

diagram	
namespace	urn:www.agenziaentrate.gov.it:specificheTecniche:sco:730
type	<a href="#">DatoAN_Type</a>
facets	Kind Value pattern ([0-9A-Z\-\] \&quot;){1}([ 0-9A-Z&amp;] '\-\-\ , /'^\(\ \) À É È Ì Ò Ù Û \&quot; \ \ \ +)*

element **Dati\_Catastali\_Type/Subalterno**

diagram	
namespace	urn:www.agenziaentrate.gov.it:specificheTecniche:sco:730
type	<a href="#">DatoAN_Type</a>
facets	Kind Value pattern ([0-9A-Z\-\] \&quot;){1}([ 0-9A-Z&amp;] '\-\-\ , /'^\(\ \) À É È Ì Ò Ù Û \&quot; \ \ \ +)*

### complexType Dati\_Condominio\_Type

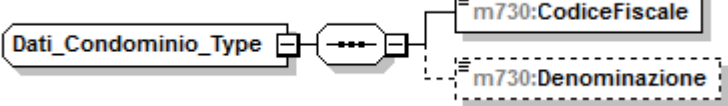
diagram	
namespace	urn:www.agenziaentrate.gov.it:specificheTecniche:sco:730
children	<a href="#">m730:CodiceFiscale</a> <a href="#">m730:Denominazione</a>

### element Dati\_Condominio\_Type/CodiceFiscale

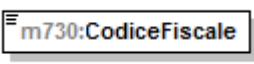
diagram					
namespace	urn:www.agenziaentrate.gov.it:specificheTecniche:sco:730				
type	<a href="#">DatoCF_Type</a>				
facets	<table border="1"> <thead> <tr> <th>Kind</th> <th>Value</th> </tr> </thead> <tbody> <tr> <td>pattern</td> <td>[0-9]{11}[A-Z]{6}[0-9LMNPQRSTUVWXYZ]{2}[A-Z]{1}[0-9LMNPQRSTUVWXYZ]{2}[A-Z]{1}[0-9LMNPQRSTUVWXYZ]{3}[A-Z]{1}</td> </tr> </tbody> </table>	Kind	Value	pattern	[0-9]{11}[A-Z]{6}[0-9LMNPQRSTUVWXYZ]{2}[A-Z]{1}[0-9LMNPQRSTUVWXYZ]{2}[A-Z]{1}[0-9LMNPQRSTUVWXYZ]{3}[A-Z]{1}
Kind	Value				
pattern	[0-9]{11}[A-Z]{6}[0-9LMNPQRSTUVWXYZ]{2}[A-Z]{1}[0-9LMNPQRSTUVWXYZ]{2}[A-Z]{1}[0-9LMNPQRSTUVWXYZ]{3}[A-Z]{1}				

### element Dati\_Condominio\_Type/Denominazione

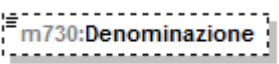
diagram					
namespace	urn:www.agenziaentrate.gov.it:specificheTecniche:sco:730				
type	<a href="#">DatoAN_Type</a>				
facets	<table border="1"> <thead> <tr> <th>Kind</th> <th>Value</th> </tr> </thead> <tbody> <tr> <td>pattern</td> <td>([0-9A-Z\-\-]&amp;quot;){1}([ 0-9A-Z&amp;amp;:] ' - \., / ° ^\(\ \) À É È Ì Ò Ù Ú Û&amp;quot; \\ / +)*</td> </tr> </tbody> </table>	Kind	Value	pattern	([0-9A-Z\-\-]&quot;){1}([ 0-9A-Z&amp;:] ' - \., / ° ^\(\ \) À É È Ì Ò Ù Ú Û&quot; \\ / +)*
Kind	Value				
pattern	([0-9A-Z\-\-]&quot;){1}([ 0-9A-Z&amp;:] ' - \., / ° ^\(\ \) À É È Ì Ò Ù Ú Û&quot; \\ / +)*				

### complexType Dati\_Coniuge\_Type

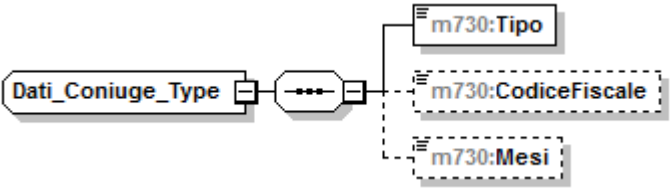
diagram	
namespace	urn:www.agenziaentrate.gov.it:specificheTecniche:sco:730
children	<a href="#">m730:Tipo</a> <a href="#">m730:CodiceFiscale</a> <a href="#">m730:Mesi</a>

### element Dati\_Coniuge\_Type/Tipo

diagram	
---------	---

namespace	urn:www.agenziaentrate.gov.it:specificheTecniche:sco:730				
type	<a href="#">DatoCB Type</a>				
facets	<table border="1"> <thead> <tr> <th>Kind</th> <th>Value</th> </tr> </thead> <tbody> <tr> <td>pattern</td> <td>[01]</td> </tr> </tbody> </table>	Kind	Value	pattern	[01]
Kind	Value				
pattern	[01]				

**element Dati\_Coniuge\_Type/CodiceFiscale**

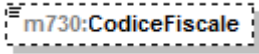
diagram					
namespace	urn:www.agenziaentrate.gov.it:specificheTecniche:sco:730				
type	<a href="#">DatoCF Type</a>				
facets	<table border="1"> <thead> <tr> <th>Kind</th> <th>Value</th> </tr> </thead> <tbody> <tr> <td>pattern</td> <td>[0-9]{11}[[A-Z]{6}[0-9LMNPQRSTU]{2}[[A-Z]{1}[0-9LMNPQRSTU]{2}[[A-Z]{1}[0-9LMNPQRSTU]{3}[[A-Z]{1}</td> </tr> </tbody> </table>	Kind	Value	pattern	[0-9]{11}[[A-Z]{6}[0-9LMNPQRSTU]{2}[[A-Z]{1}[0-9LMNPQRSTU]{2}[[A-Z]{1}[0-9LMNPQRSTU]{3}[[A-Z]{1}
Kind	Value				
pattern	[0-9]{11}[[A-Z]{6}[0-9LMNPQRSTU]{2}[[A-Z]{1}[0-9LMNPQRSTU]{2}[[A-Z]{1}[0-9LMNPQRSTU]{3}[[A-Z]{1}				

**element Dati\_Coniuge\_Type/Mesi**

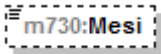
diagram																													
namespace	urn:www.agenziaentrate.gov.it:specificheTecniche:sco:730																												
type	<a href="#">m730:Mesi Type</a>																												
facets	<table border="1"> <thead> <tr> <th>Kind</th> <th>Value</th> </tr> </thead> <tbody> <tr> <td>pattern</td> <td>[1-9]{1}[0-9]*</td> </tr> <tr> <td>enumeration</td> <td>1</td> </tr> <tr> <td>enumeration</td> <td>2</td> </tr> <tr> <td>enumeration</td> <td>3</td> </tr> <tr> <td>enumeration</td> <td>4</td> </tr> <tr> <td>enumeration</td> <td>5</td> </tr> <tr> <td>enumeration</td> <td>6</td> </tr> <tr> <td>enumeration</td> <td>7</td> </tr> <tr> <td>enumeration</td> <td>8</td> </tr> <tr> <td>enumeration</td> <td>9</td> </tr> <tr> <td>enumeration</td> <td>10</td> </tr> <tr> <td>enumeration</td> <td>11</td> </tr> <tr> <td>enumeration</td> <td>12</td> </tr> </tbody> </table>	Kind	Value	pattern	[1-9]{1}[0-9]*	enumeration	1	enumeration	2	enumeration	3	enumeration	4	enumeration	5	enumeration	6	enumeration	7	enumeration	8	enumeration	9	enumeration	10	enumeration	11	enumeration	12
Kind	Value																												
pattern	[1-9]{1}[0-9]*																												
enumeration	1																												
enumeration	2																												
enumeration	3																												
enumeration	4																												
enumeration	5																												
enumeration	6																												
enumeration	7																												
enumeration	8																												
enumeration	9																												
enumeration	10																												
enumeration	11																												
enumeration	12																												

complexType **Dati\_Contabili\_Type**

<p>diagram</p>	
<p>namespace</p>	<p>urn:www.agenziaentrate.gov.it:specificheTecniche:sco:730</p>
<p>children</p>	<p><a href="#">m730:Familiari</a> <a href="#">m730:QuadroA</a> <a href="#">m730:QuadroB</a> <a href="#">m730:QuadroC</a> <a href="#">m730:QuadroD</a> <a href="#">m730:QuadroE</a> <a href="#">m730:QuadroF</a> <a href="#">m730:QuadroG</a> <a href="#">m730:QuadroI</a> <a href="#">m730:ProspettoLiquidazione</a> <a href="#">m730:Prospetto_Annotazioni</a> <a href="#">m730:QuadroK</a></p>

element **Dati\_Contabili\_Type/Familiari**

<p>diagram</p>	
<p>namespace</p>	<p>urn:www.agenziaentrate.gov.it:specificheTecniche:sco:730</p>
<p>type</p>	<p><a href="#">m730:Familiari_Type</a></p>
<p>children</p>	<p><a href="#">m730:PrimoModulo</a> <a href="#">m730:Modulo</a></p>

element **Dati\_Contabili\_Type/QuadroA**

diagram	<p>The diagram shows a sequence container (yellow dashed box) labeled 'm730:Redditi_Terreni_Type'. Inside, a dashed box labeled 'm730:QuadroA' is connected to a sequence container (white dashed box) which is connected to a box labeled 'm730:Modulo' with a cardinality of '1..∞'.</p>
namespace	urn:www.agenziaentrate.gov.it:specificheTecniche:sco:730
type	<a href="#">m730:Redditi_Terreni_Type</a>
children	<a href="#">m730:Modulo</a>

element **Dati\_Contabili\_Type/QuadroB**

diagram	<p>The diagram shows a sequence container (yellow dashed box) labeled 'm730:Redditi_Fabbricati_Type'. Inside, a dashed box labeled 'm730:QuadroB' is connected to a sequence container (white dashed box) which is connected to a box labeled 'm730:Modulo' with a cardinality of '1..∞'.</p>
namespace	urn:www.agenziaentrate.gov.it:specificheTecniche:sco:730
type	<a href="#">m730:Redditi_Fabbricati_Type</a>
children	<a href="#">m730:Modulo</a>

element **Dati\_Contabili\_Type/QuadroC**

diagram	<p>The diagram shows a sequence container (yellow dashed box) labeled 'm730:Redditi_Lavoro_Dip_Type'. Inside, a dashed box labeled 'm730:QuadroC' is connected to a sequence container (white dashed box). This container branches into two paths: one leading to a box labeled 'm730:PrimoModulo' and another leading to a dashed box labeled 'm730:Modulo' with a cardinality of '0..∞'.</p>
namespace	urn:www.agenziaentrate.gov.it:specificheTecniche:sco:730
type	<a href="#">m730:Redditi_Lavoro_Dip_Type</a>
children	<a href="#">m730:PrimoModulo</a> <a href="#">m730:Modulo</a>

element **Dati\_Contabili\_Type/QuadroD**

diagram	<p>The diagram shows a sequence container (yellow dashed box) labeled 'm730:Altri_Redditi_Type (extension)'. Inside, a dashed box labeled 'm730:QuadroD' is connected to a sequence container (white dashed box) which is connected to a box labeled 'm730:Modulo' with a cardinality of '1..∞'.</p>
---------	--

namespace	urn:www.agenziaentrate.gov.it:specificheTecniche:sco:730
type	extension of <a href="#">m730:Altri_Reddito_Type</a>
children	<a href="#">m730:Modulo</a>

**element Dati\_Contabili\_Type/QuadroE**

diagram	
namespace	urn:www.agenziaentrate.gov.it:specificheTecniche:sco:730
type	<a href="#">m730:Oneri_Type</a>
children	<a href="#">m730:PrimoModulo</a> <a href="#">m730:Modulo</a>

**element Dati\_Contabili\_Type/QuadroF**

diagram	
namespace	urn:www.agenziaentrate.gov.it:specificheTecniche:sco:730
type	<a href="#">m730:Acconti_Ritenute_Type</a>
children	<a href="#">m730:PrimoModulo</a> <a href="#">m730:Modulo</a>

**element Dati\_Contabili\_Type/QuadroG**

diagram	
namespace	urn:www.agenziaentrate.gov.it:specificheTecniche:sco:730
type	<a href="#">m730:Crediti_Imposta_Type</a>

children	<a href="#">m730:PrimoModulo</a> <a href="#">m730:Modulo</a>
----------	--

element **Dati\_Contabili\_Type/Quadrol**

diagram	
namespace	urn:www.agenziaentrate.gov.it:specificheTecniche:sco:730
type	<a href="#">m730:Quadro_I_Type</a>
children	<a href="#">m730:Importo</a> <a href="#">m730:Casella</a>

element **Dati\_Contabili\_Type/ProspettoLiquidazione**

diagram	
namespace	urn:www.agenziaentrate.gov.it:specificheTecniche:sco:730
type	<a href="#">m730:Prospetto_Liquidazione_Type</a>
children	<a href="#">m730:PrimoModulo</a> <a href="#">m730:Modulo</a>

element **Dati\_Contabili\_Type/Prospetto\_Annotazioni**

diagram	
namespace	urn:www.agenziaentrate.gov.it:specificheTecniche:sco:730
type	<a href="#">m730:Prospetto_Annotazioni_Type</a>
children	<a href="#">m730:Modulo_Annotazioni</a>

element **Dati\_Contabili\_Type/QuadroK**

diagram	
namespace	urn:www.agenziaentrate.gov.it:specificheTecniche:sco:730
type	<a href="#">m730:Comunicazione_Amministratore_Type</a>
children	<a href="#">m730:Modulo</a>

complexType **Dati\_Contratto\_Type**

diagram	
namespace	urn:www.agenziaentrate.gov.it:specificheTecniche:sco:730
children	<a href="#">m730:DataRegContratto</a> <a href="#">m730:SerieContratto</a> <a href="#">m730:NumeroContratto</a> <a href="#">m730:Sottonumero</a> <a href="#">m730:CodiceUfficio</a> <a href="#">m730:IdentificativoContratto</a>

element **Dati\_Contratto\_Type/DataRegContratto**

diagram					
namespace	urn:www.agenziaentrate.gov.it:specificheTecniche:sco:730				
type	<a href="#">DatoDT_Type</a>				
facets	<table border="1"> <thead> <tr> <th>Kind</th> <th>Value</th> </tr> </thead> <tbody> <tr> <td>pattern</td> <td>((([0-9]{1,12} [0-9]{3,10} 0[13578]1012\d{4})) ([0-9]{1,12} [0-9]{3,10} 0[469]11\d{4})) ([0-9]{1,12} [0-9]{2,8} 02\d{4})) ((29)02([02468]048)00) ((29)02([13579]26)00) ((29)02([0-9]0[048]) ((29)02([0-9]0[2468]048)) ((29)02([0-9]0[13579]26)))</td> </tr> </tbody> </table>	Kind	Value	pattern	((([0-9]{1,12} [0-9]{3,10} 0[13578]1012\d{4})) ([0-9]{1,12} [0-9]{3,10} 0[469]11\d{4})) ([0-9]{1,12} [0-9]{2,8} 02\d{4})) ((29)02([02468]048)00) ((29)02([13579]26)00) ((29)02([0-9]0[048]) ((29)02([0-9]0[2468]048)) ((29)02([0-9]0[13579]26)))
Kind	Value				
pattern	((([0-9]{1,12} [0-9]{3,10} 0[13578]1012\d{4})) ([0-9]{1,12} [0-9]{3,10} 0[469]11\d{4})) ([0-9]{1,12} [0-9]{2,8} 02\d{4})) ((29)02([02468]048)00) ((29)02([13579]26)00) ((29)02([0-9]0[048]) ((29)02([0-9]0[2468]048)) ((29)02([0-9]0[13579]26)))				

element **Dati\_Contratto\_Type/SerieContratto**

diagram	
namespace	urn:www.agenziaentrate.gov.it:specificheTecniche:sco:730





### complexType Dati\_Familiare\_Type

diagram	
namespace	urn:www.agenziaentrate.gov.it:specificheTecniche:sco:730
children	<a href="#">m730:CodiceFiscale</a> <a href="#">m730:Mesi</a> <a href="#">m730:MesiMinore</a> <a href="#">m730:PercDetraz</a> <a href="#">m730:PercDetrazCon</a> <a href="#">m730:Affidamento</a>

### element Dati\_Familiare\_Type/CodiceFiscale

diagram					
namespace	urn:www.agenziaentrate.gov.it:specificheTecniche:sco:730				
type	<a href="#">DatoCF_Type</a>				
facets	<table border="1"> <thead> <tr> <th>Kind</th> <th>Value</th> </tr> </thead> <tbody> <tr> <td>pattern</td> <td>[0-9]{11}[A-Z]{6}[0-9LMNPQRSTUUV]{2}[A-Z]{1}[0-9LMNPQRSTUUV]{2}[A-Z]{1}[0-9LMNPQRSTUUV]{3}[A-Z]{1}</td> </tr> </tbody> </table>	Kind	Value	pattern	[0-9]{11}[A-Z]{6}[0-9LMNPQRSTUUV]{2}[A-Z]{1}[0-9LMNPQRSTUUV]{2}[A-Z]{1}[0-9LMNPQRSTUUV]{3}[A-Z]{1}
Kind	Value				
pattern	[0-9]{11}[A-Z]{6}[0-9LMNPQRSTUUV]{2}[A-Z]{1}[0-9LMNPQRSTUUV]{2}[A-Z]{1}[0-9LMNPQRSTUUV]{3}[A-Z]{1}				

### element Dati\_Familiare\_Type/Mesi

diagram					
namespace	urn:www.agenziaentrate.gov.it:specificheTecniche:sco:730				
type	<a href="#">DatoNP_Type</a>				
facets	<table border="1"> <thead> <tr> <th>Kind</th> <th>Value</th> </tr> </thead> <tbody> <tr> <td>pattern</td> <td>[1-9]{1}[0-9]*</td> </tr> </tbody> </table>	Kind	Value	pattern	[1-9]{1}[0-9]*
Kind	Value				
pattern	[1-9]{1}[0-9]*				

### element Dati\_Familiare\_Type/MesiMinore

diagram					
namespace	urn:www.agenziaentrate.gov.it:specificheTecniche:sco:730				
type	<a href="#">DatoNP_Type</a>				
facets	<table border="1"> <thead> <tr> <th>Kind</th> <th>Value</th> </tr> </thead> <tbody> <tr> <td>pattern</td> <td>[1-9]{1}[0-9]*</td> </tr> </tbody> </table>	Kind	Value	pattern	[1-9]{1}[0-9]*
Kind	Value				
pattern	[1-9]{1}[0-9]*				

element **Dati\_Familiare\_Type/PercDetraz**

diagram					
namespace	urn:www.agenziaentrate.gov.it:specificheTecniche:sco:730				
type	<a href="#">DatoPC_Type</a>				
facets	<table border="1"> <tr> <td>Kind</td> <td>Value</td> </tr> <tr> <td>pattern</td> <td>[0-9]?[0-9](, d{1,3})? 100,0{1,3}?</td> </tr> </table>	Kind	Value	pattern	[0-9]?[0-9](, d{1,3})? 100,0{1,3}?
Kind	Value				
pattern	[0-9]?[0-9](, d{1,3})? 100,0{1,3}?				

element **Dati\_Familiare\_Type/PercDetrazCon**

diagram					
namespace	urn:www.agenziaentrate.gov.it:specificheTecniche:sco:730				
type	<a href="#">DatoAN_Type</a>				
facets	<table border="1"> <tr> <td>Kind</td> <td>Value</td> </tr> <tr> <td>pattern</td> <td>([0-9A-Z\-\] \&amp;quot;){1}([ 0-9A-Z&amp;amp;] '\ -\ \. , / \°\^\(\ \)\ À É È Ì Ò Ù Û \&amp;quot; \ \\ \ +)*</td> </tr> </table>	Kind	Value	pattern	([0-9A-Z\-\] \&quot;){1}([ 0-9A-Z&amp;] '\ -\ \. , / \°\^\(\ \)\ À É È Ì Ò Ù Û \&quot; \ \\ \ +)*
Kind	Value				
pattern	([0-9A-Z\-\] \&quot;){1}([ 0-9A-Z&amp;] '\ -\ \. , / \°\^\(\ \)\ À É È Ì Ò Ù Û \&quot; \ \\ \ +)*				

element **Dati\_Familiare\_Type/Affidamento**

diagram					
namespace	urn:www.agenziaentrate.gov.it:specificheTecniche:sco:730				
type	<a href="#">DatoCB_Type</a>				
facets	<table border="1"> <tr> <td>Kind</td> <td>Value</td> </tr> <tr> <td>pattern</td> <td>[01]</td> </tr> </table>	Kind	Value	pattern	[01]
Kind	Value				
pattern	[01]				

complexType **Dati\_Fornitore\_Type**

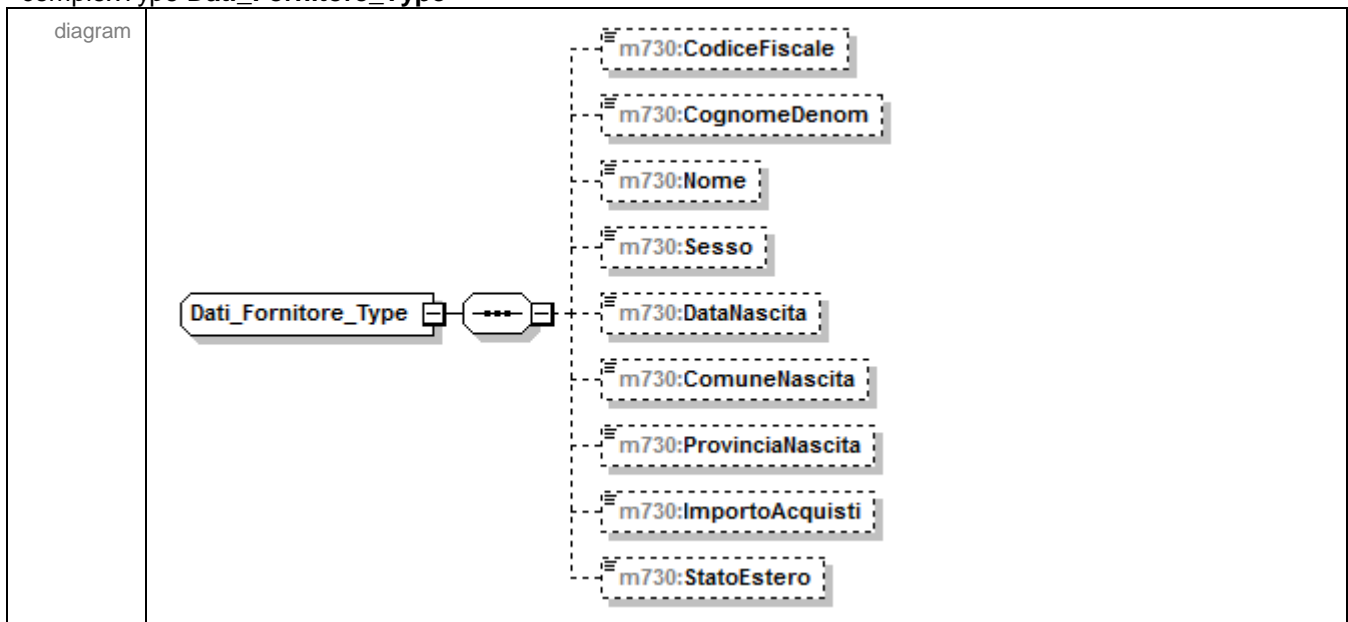

namespace	urn:www.agenziaentrate.gov.it:specificheTecniche:sco:730
children	<a href="#">m730:CodiceFiscale</a> <a href="#">m730:CognomeDenom</a> <a href="#">m730:Nome</a> <a href="#">m730:Sesso</a> <a href="#">m730:DataNascita</a> <a href="#">m730:ComuneNascita</a> <a href="#">m730:ProvinciaNascita</a> <a href="#">m730:ImportoAcquisti</a> <a href="#">m730:StatoEstero</a>

#### element Dati\_Fornitore\_Type/CodiceFiscale

diagram					
namespace	urn:www.agenziaentrate.gov.it:specificheTecniche:sco:730				
type	<a href="#">DatoCF_Type</a>				
facets	<table border="1"> <tr> <td>Kind</td> <td>Value</td> </tr> <tr> <td>pattern</td> <td>[0-9]{11}[A-Z]{6}[0-9LMNPQRSTU]{2}[A-Z]{1}[0-9LMNPQRSTU]{2}[A-Z]{1}[0-9LMNPQRSTU]{3}[A-Z]{1}</td> </tr> </table>	Kind	Value	pattern	[0-9]{11}[A-Z]{6}[0-9LMNPQRSTU]{2}[A-Z]{1}[0-9LMNPQRSTU]{2}[A-Z]{1}[0-9LMNPQRSTU]{3}[A-Z]{1}
Kind	Value				
pattern	[0-9]{11}[A-Z]{6}[0-9LMNPQRSTU]{2}[A-Z]{1}[0-9LMNPQRSTU]{2}[A-Z]{1}[0-9LMNPQRSTU]{3}[A-Z]{1}				

#### element Dati\_Fornitore\_Type/CognomeDenom

diagram					
namespace	urn:www.agenziaentrate.gov.it:specificheTecniche:sco:730				
type	<a href="#">DatoAN_Type</a>				
facets	<table border="1"> <tr> <td>Kind</td> <td>Value</td> </tr> <tr> <td>pattern</td> <td>([0-9A-Z-] \&amp;quot;){1}([ 0-9A-Z&amp;amp;#39; ' \"- . , / ° \"^\"(\\) À È É Ì Ò Ù Û &amp;quot; \\\" \\+)*</td> </tr> </table>	Kind	Value	pattern	([0-9A-Z-] \&quot;){1}([ 0-9A-Z&amp;#39; ' \"- . , / ° \"^\"(\\) À È É Ì Ò Ù Û &quot; \\\" \\+)*
Kind	Value				
pattern	([0-9A-Z-] \&quot;){1}([ 0-9A-Z&amp;#39; ' \"- . , / ° \"^\"(\\) À È É Ì Ò Ù Û &quot; \\\" \\+)*				

#### element Dati\_Fornitore\_Type/Nome

diagram					
namespace	urn:www.agenziaentrate.gov.it:specificheTecniche:sco:730				
type	<a href="#">DatoAN_Type</a>				
facets	<table border="1"> <tr> <td>Kind</td> <td>Value</td> </tr> <tr> <td>pattern</td> <td>([0-9A-Z-] \&amp;quot;){1}([ 0-9A-Z&amp;amp;#39; ' \"- . , / ° \"^\"(\\) À È É Ì Ò Ù Û &amp;quot; \\\" \\+)*</td> </tr> </table>	Kind	Value	pattern	([0-9A-Z-] \&quot;){1}([ 0-9A-Z&amp;#39; ' \"- . , / ° \"^\"(\\) À È É Ì Ò Ù Û &quot; \\\" \\+)*
Kind	Value				
pattern	([0-9A-Z-] \&quot;){1}([ 0-9A-Z&amp;#39; ' \"- . , / ° \"^\"(\\) À È É Ì Ò Ù Û &quot; \\\" \\+)*				

#### element Dati\_Fornitore\_Type/Sesso

diagram									
namespace	urn:www.agenziaentrate.gov.it:specificheTecniche:sco:730								
type	<a href="#">Sesso_Type</a>								
facets	<table border="1"> <tr> <td>Kind</td> <td>Value</td> </tr> <tr> <td>pattern</td> <td>([0-9A-Z-] \&amp;quot;){1}([ 0-9A-Z&amp;amp;#39; ' \"- . , / ° \"^\"(\\) À È É Ì Ò Ù Û &amp;quot; \\\" \\+)*</td> </tr> <tr> <td>enumeration</td> <td>M</td> </tr> <tr> <td>enumeration</td> <td>F</td> </tr> </table>	Kind	Value	pattern	([0-9A-Z-] \&quot;){1}([ 0-9A-Z&amp;#39; ' \"- . , / ° \"^\"(\\) À È É Ì Ò Ù Û &quot; \\\" \\+)*	enumeration	M	enumeration	F
Kind	Value								
pattern	([0-9A-Z-] \&quot;){1}([ 0-9A-Z&amp;#39; ' \"- . , / ° \"^\"(\\) À È É Ì Ò Ù Û &quot; \\\" \\+)*								
enumeration	M								
enumeration	F								



complexType **Dati\_Nascita\_PF\_Type**

diagram	
namespace	urn:www.agenziaentrate.gov.it:specificheTecniche:sco:730
children	<a href="#">m730:Sesso</a> <a href="#">m730:DataNascita</a> <a href="#">m730:ComuneNascita</a> <a href="#">m730:ProvinciaNascita</a>

element **Dati\_Nascita\_PF\_Type/Sesso**

diagram									
namespace	urn:www.agenziaentrate.gov.it:specificheTecniche:sco:730								
type	<a href="#">Sesso_Type</a>								
facets	<table border="0"> <tr> <td>Kind</td> <td>Value</td> </tr> <tr> <td>pattern</td> <td>([0-9A-Z-] &amp;quot;){1}([ 0-9A-Z&amp;amp;] ' - \., / ° °\^\(\ )\ À È É Ì Ò Ù Ü &amp;quot;; \\ / +)*</td> </tr> <tr> <td>enumeration</td> <td>M</td> </tr> <tr> <td>enumeration</td> <td>F</td> </tr> </table>	Kind	Value	pattern	([0-9A-Z-] &quot;){1}([ 0-9A-Z&amp;] ' - \., / ° °\^\(\ )\ À È É Ì Ò Ù Ü &quot;; \\ / +)*	enumeration	M	enumeration	F
Kind	Value								
pattern	([0-9A-Z-] &quot;){1}([ 0-9A-Z&amp;] ' - \., / ° °\^\(\ )\ À È É Ì Ò Ù Ü &quot;; \\ / +)*								
enumeration	M								
enumeration	F								

element **Dati\_Nascita\_PF\_Type/DataNascita**

diagram					
namespace	urn:www.agenziaentrate.gov.it:specificheTecniche:sco:730				
type	<a href="#">DatoDT_Type</a>				
facets	<table border="0"> <tr> <td>Kind</td> <td>Value</td> </tr> <tr> <td>pattern</td> <td>((([0-9]{12}[0-9]{3}[01])(0[13578][10]12)\d{4})) ((([0-9]{12}[0-9]{30})(0[469][11]\d{4})) ((0[1-9][1[0-9]]2[0-8])(02)\d{4})) ((29)(02)([02468][048]00)) ((29)(02)([13579][26]00)) ((29)(02)([0-9][0-9][0][48])) ((29)(02)([0-9][0-9][2468][048])) ((29)(02)([0-9][0-9][13579][26]))</td> </tr> </table>	Kind	Value	pattern	((([0-9]{12}[0-9]{3}[01])(0[13578][10]12)\d{4})) ((([0-9]{12}[0-9]{30})(0[469][11]\d{4})) ((0[1-9][1[0-9]]2[0-8])(02)\d{4})) ((29)(02)([02468][048]00)) ((29)(02)([13579][26]00)) ((29)(02)([0-9][0-9][0][48])) ((29)(02)([0-9][0-9][2468][048])) ((29)(02)([0-9][0-9][13579][26]))
Kind	Value				
pattern	((([0-9]{12}[0-9]{3}[01])(0[13578][10]12)\d{4})) ((([0-9]{12}[0-9]{30})(0[469][11]\d{4})) ((0[1-9][1[0-9]]2[0-8])(02)\d{4})) ((29)(02)([02468][048]00)) ((29)(02)([13579][26]00)) ((29)(02)([0-9][0-9][0][48])) ((29)(02)([0-9][0-9][2468][048])) ((29)(02)([0-9][0-9][13579][26]))				

element **Dati\_Nascita\_PF\_Type/ComuneNascita**

diagram					
namespace	urn:www.agenziaentrate.gov.it:specificheTecniche:sco:730				
type	<a href="#">DatoAN_Type</a>				
facets	<table border="0"> <tr> <td>Kind</td> <td>Value</td> </tr> <tr> <td>pattern</td> <td>([0-9A-Z-] &amp;quot;){1}([ 0-9A-Z&amp;amp;] ' - \., / ° °\^\(\ )\ À È É Ì Ò Ù Ü &amp;quot;; \\ / +)*</td> </tr> </table>	Kind	Value	pattern	([0-9A-Z-] &quot;){1}([ 0-9A-Z&amp;] ' - \., / ° °\^\(\ )\ À È É Ì Ò Ù Ü &quot;; \\ / +)*
Kind	Value				
pattern	([0-9A-Z-] &quot;){1}([ 0-9A-Z&amp;] ' - \., / ° °\^\(\ )\ À È É Ì Ò Ù Ü &quot;; \\ / +)*				

element **Dati\_Nascita\_PF\_Type/ProvinciaNascita**

diagram	
namespace	urn:www.agenziaentrate.gov.it:specificheTecniche:sco:730
type	<a href="#">PN_Type</a>

complexType **Dati\_Primo\_Figlio\_Type**

diagram	
namespace	urn:www.agenziaentrate.gov.it:specificheTecniche:sco:730
children	<a href="#">m730:Tipo</a> <a href="#">m730:CodiceFiscale</a> <a href="#">m730:Mesi</a> <a href="#">m730:MesiMinore</a> <a href="#">m730:PercDetraz</a> <a href="#">m730:Affidamento</a>

element **Dati\_Primo\_Figlio\_Type/Tipo**

diagram									
namespace	urn:www.agenziaentrate.gov.it:specificheTecniche:sco:730								
type	restriction of <a href="#">DatoAN_Type</a>								
facets	<table border="0"> <tr> <td>Kind</td> <td>Value</td> </tr> <tr> <td>pattern</td> <td>(([0-9A-Z-])&amp;quot;){1}([ 0-9A-Z&amp;amp;:] ' - .!, / ^\(\\) À È É Ì Ò Ù Ü &amp;quot; \\ / +)*</td> </tr> <tr> <td>enumeration</td> <td>F</td> </tr> <tr> <td>enumeration</td> <td>D</td> </tr> </table>	Kind	Value	pattern	(([0-9A-Z-])&quot;){1}([ 0-9A-Z&amp;:] ' - .!, / ^\(\\) À È É Ì Ò Ù Ü &quot; \\ / +)*	enumeration	F	enumeration	D
Kind	Value								
pattern	(([0-9A-Z-])&quot;){1}([ 0-9A-Z&amp;:] ' - .!, / ^\(\\) À È É Ì Ò Ù Ü &quot; \\ / +)*								
enumeration	F								
enumeration	D								

element **Dati\_Primo\_Figlio\_Type/CodiceFiscale**

diagram					
namespace	urn:www.agenziaentrate.gov.it:specificheTecniche:sco:730				
type	<a href="#">DatoCF_Type</a>				
facets	<table border="0"> <tr> <td>Kind</td> <td>Value</td> </tr> <tr> <td>pattern</td> <td>[0-9]{11}[A-Z]{6}[0-9LMNPQRSTU]{2}[A-Z]{1}[0-9LMNPQRSTU]{2}[A-Z]{1}[0-9LMNPQRSTU]{3}[A-Z]{1}</td> </tr> </table>	Kind	Value	pattern	[0-9]{11}[A-Z]{6}[0-9LMNPQRSTU]{2}[A-Z]{1}[0-9LMNPQRSTU]{2}[A-Z]{1}[0-9LMNPQRSTU]{3}[A-Z]{1}
Kind	Value				
pattern	[0-9]{11}[A-Z]{6}[0-9LMNPQRSTU]{2}[A-Z]{1}[0-9LMNPQRSTU]{2}[A-Z]{1}[0-9LMNPQRSTU]{3}[A-Z]{1}				

element **Dati\_Primo\_Figlio\_Type/Mesi**

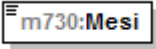
diagram																													
namespace	urn:www.agenziaentrate.gov.it:specificheTecniche:sco:730																												
type	<a href="#">m730:Mesi_Type</a>																												
facets	<table border="1"> <thead> <tr> <th>Kind</th> <th>Value</th> </tr> </thead> <tbody> <tr> <td>pattern</td> <td>[1-9]{1}[0-9]*</td> </tr> <tr> <td>enumeration</td> <td>1</td> </tr> <tr> <td>enumeration</td> <td>2</td> </tr> <tr> <td>enumeration</td> <td>3</td> </tr> <tr> <td>enumeration</td> <td>4</td> </tr> <tr> <td>enumeration</td> <td>5</td> </tr> <tr> <td>enumeration</td> <td>6</td> </tr> <tr> <td>enumeration</td> <td>7</td> </tr> <tr> <td>enumeration</td> <td>8</td> </tr> <tr> <td>enumeration</td> <td>9</td> </tr> <tr> <td>enumeration</td> <td>10</td> </tr> <tr> <td>enumeration</td> <td>11</td> </tr> <tr> <td>enumeration</td> <td>12</td> </tr> </tbody> </table>	Kind	Value	pattern	[1-9]{1}[0-9]*	enumeration	1	enumeration	2	enumeration	3	enumeration	4	enumeration	5	enumeration	6	enumeration	7	enumeration	8	enumeration	9	enumeration	10	enumeration	11	enumeration	12
Kind	Value																												
pattern	[1-9]{1}[0-9]*																												
enumeration	1																												
enumeration	2																												
enumeration	3																												
enumeration	4																												
enumeration	5																												
enumeration	6																												
enumeration	7																												
enumeration	8																												
enumeration	9																												
enumeration	10																												
enumeration	11																												
enumeration	12																												

element **Dati\_Primo\_Figlio\_Type/MesiMinore**

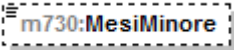
diagram																													
namespace	urn:www.agenziaentrate.gov.it:specificheTecniche:sco:730																												
type	<a href="#">m730:Mesi_Type</a>																												
facets	<table border="1"> <thead> <tr> <th>Kind</th> <th>Value</th> </tr> </thead> <tbody> <tr> <td>pattern</td> <td>[1-9]{1}[0-9]*</td> </tr> <tr> <td>enumeration</td> <td>1</td> </tr> <tr> <td>enumeration</td> <td>2</td> </tr> <tr> <td>enumeration</td> <td>3</td> </tr> <tr> <td>enumeration</td> <td>4</td> </tr> <tr> <td>enumeration</td> <td>5</td> </tr> <tr> <td>enumeration</td> <td>6</td> </tr> <tr> <td>enumeration</td> <td>7</td> </tr> <tr> <td>enumeration</td> <td>8</td> </tr> <tr> <td>enumeration</td> <td>9</td> </tr> <tr> <td>enumeration</td> <td>10</td> </tr> <tr> <td>enumeration</td> <td>11</td> </tr> <tr> <td>enumeration</td> <td>12</td> </tr> </tbody> </table>	Kind	Value	pattern	[1-9]{1}[0-9]*	enumeration	1	enumeration	2	enumeration	3	enumeration	4	enumeration	5	enumeration	6	enumeration	7	enumeration	8	enumeration	9	enumeration	10	enumeration	11	enumeration	12
Kind	Value																												
pattern	[1-9]{1}[0-9]*																												
enumeration	1																												
enumeration	2																												
enumeration	3																												
enumeration	4																												
enumeration	5																												
enumeration	6																												
enumeration	7																												
enumeration	8																												
enumeration	9																												
enumeration	10																												
enumeration	11																												
enumeration	12																												

element **Dati\_Primo\_Figlio\_Type/PercDetraz**

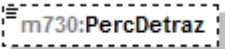
diagram					
namespace	urn:www.agenziaentrate.gov.it:specificheTecniche:sco:730				
type	<a href="#">DatoPC_Type</a>				
facets	<table border="1"> <thead> <tr> <th>Kind</th> <th>Value</th> </tr> </thead> <tbody> <tr> <td>pattern</td> <td>[0-9]?[0-9](,\d{1,3})? 100,(0{1,3})?</td> </tr> </tbody> </table>	Kind	Value	pattern	[0-9]?[0-9](,\d{1,3})? 100,(0{1,3})?
Kind	Value				
pattern	[0-9]?[0-9](,\d{1,3})? 100,(0{1,3})?				



element **Dati\_Primo\_Figlio\_Type/Affidamento**

diagram	
namespace	urn:www.agenziaentrate.gov.it:specificheTecniche:sco:730
type	<a href="#">DatoCB_Type</a>
facets	Kind Value pattern [01]

complexType **Dati\_Professionista\_Type**

diagram	
namespace	urn:www.agenziaentrate.gov.it:specificheTecniche:sco:730
children	<a href="#">m730:CFProfessionista</a> <a href="#">m730:CognomeProfessionista</a> <a href="#">m730:NomeProfessionista</a>

element **Dati\_Professionista\_Type/CFProfessionista**

diagram	
namespace	urn:www.agenziaentrate.gov.it:specificheTecniche:sco:730
type	<a href="#">DatoCF_Type</a>
facets	Kind Value pattern [0-9]{11}[[A-Z]{6}[0-9LMNPQRSTUUV]{2}[[A-Z]{1}[0-9LMNPQRSTUUV]{2}[[A-Z]{1}[0-9LMNPQRSTUUV]{3}[[A-Z]{1}]

element **Dati\_Professionista\_Type/CognomeProfessionista**

diagram	
namespace	urn:www.agenziaentrate.gov.it:specificheTecniche:sco:730
type	<a href="#">DatoAN_Type</a>
facets	Kind Value pattern (([0-9A-Z-] \&quot;){1}([ 0-9A-Z&amp;#39; ! - \., / ^*\(\)\ À É È Ì Ò Ù Û &quot; \ \\ \ +)*

element **Dati\_Professionista\_Type/NomeProfessionista**

diagram	
namespace	urn:www.agenziaentrate.gov.it:specificheTecniche:sco:730
type	<a href="#">DatoAN_Type</a>

facets	Kind	Value
	pattern	([0-9A-Z-] \&quot;){1}([ 0-9A-Z&amp;:] ' \" \" _ / ^ ° \"\\( \\) À É Ê Ë Ì Ó Ù Ú &quot; \\ \\ \\ +)*

**complexType Dati\_Registrazione\_Accatastamento\_Recupero\_Patrimonio\_Edilizio\_Type**

diagram	
namespace	urn:www.agenziaentrate.gov.it:specificheTecniche:sco:730
children	<a href="#">m730:NOrdImmobile</a> <a href="#">m730:Condominio</a> <a href="#">m730:EstremiRegistrazioneContratto</a> <a href="#">m730:DomandaAccatastamento</a>

**element Dati\_Registrazione\_Accatastamento\_Recupero\_Patrimonio\_Edilizio\_Type/NOrdImmobile**

diagram	
namespace	urn:www.agenziaentrate.gov.it:specificheTecniche:sco:730
type	<a href="#">DatoNP_Type</a>
facets	Kind Value pattern [1-9]{1}[0-9]*

**element Dati\_Registrazione\_Accatastamento\_Recupero\_Patrimonio\_Edilizio\_Type/Condominio**

diagram	
namespace	urn:www.agenziaentrate.gov.it:specificheTecniche:sco:730
type	<a href="#">DatoCB_Type</a>
facets	Kind Value pattern [01]

element

### Dati\_Registrazione\_Accatastamento\_Recupero\_Patrimonio\_Edilizio\_Type/EstremiRegistrazioneContra tto

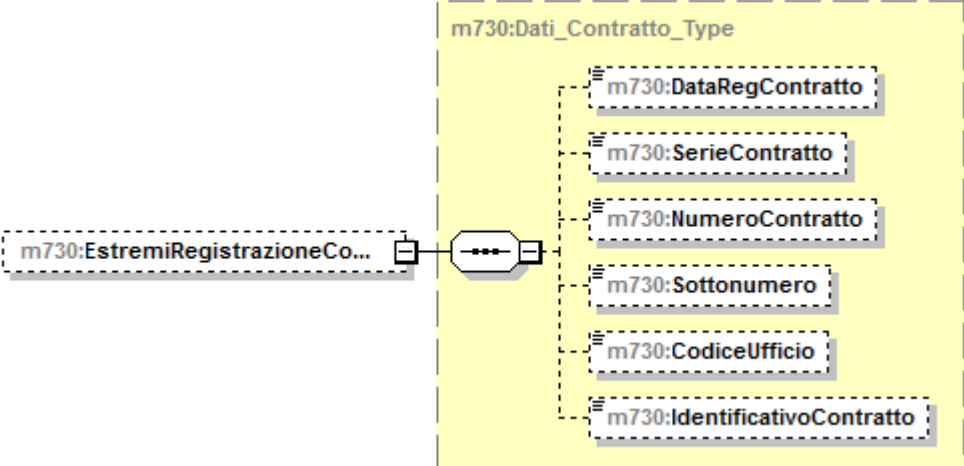
diagram	
namespace	urn:www.agenziaentrate.gov.it:specificheTecniche:sco:730
type	<a href="#">m730:Dati_Contratto_Type</a>
children	<a href="#">m730:DataRegContratto</a> <a href="#">m730:SerieContratto</a> <a href="#">m730:NumeroContratto</a> <a href="#">m730:Sottonumero</a> <a href="#">m730:CodiceUfficio</a> <a href="#">m730:IdentificativoContratto</a>

element

### Dati\_Registrazione\_Accatastamento\_Recupero\_Patrimonio\_Edilizio\_Type/DomandaAccatastamento

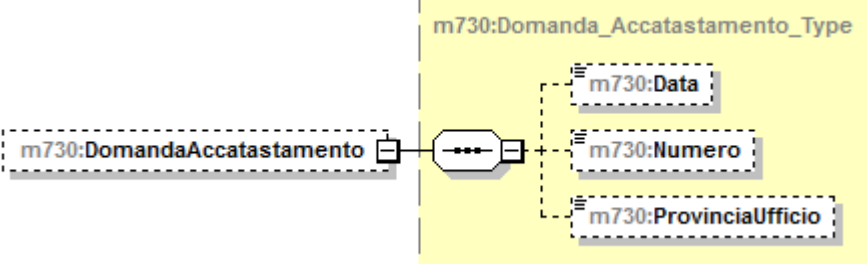
diagram	
namespace	urn:www.agenziaentrate.gov.it:specificheTecniche:sco:730
type	<a href="#">m730:Domanda_Accatastamento_Type</a>
children	<a href="#">m730:Data</a> <a href="#">m730:Numero</a> <a href="#">m730:ProvinciaUfficio</a>

### complexType Dati\_Rettificati\_Type

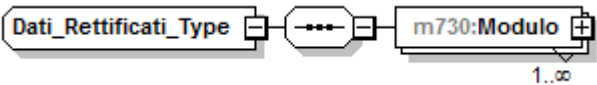
diagram	
namespace	urn:www.agenziaentrate.gov.it:specificheTecniche:sco:730
children	<a href="#">m730:Modulo</a>

element **Dati\_Rettificati\_Type/Modulo**

diagram	
namespace	urn:www.agenziaentrate.gov.it:specificheTecniche:sco:730
type	<a href="#">m730:Modulo_Dati_Rettificati_Type</a>
children	<a href="#">m730:Rettifica</a>

complexType **Modulo\_Dati\_Rettificati\_Type**

diagram	
namespace	urn:www.agenziaentrate.gov.it:specificheTecniche:sco:730
children	<a href="#">m730:Rettifica</a>

element **Dati\_Rettificati\_Type/Rettifica**

diagram	
namespace	urn:www.agenziaentrate.gov.it:specificheTecniche:sco:730
type	<a href="#">m730:Rettifica_Type</a>
children	<a href="#">m730:Quadro</a> <a href="#">m730:Rigo</a> <a href="#">m730:Colonna</a> <a href="#">m730:Modulo</a> <a href="#">m730:DatoRimosso</a>

complexType **Debito\_Type**

diagram	
namespace	urn:www.agenziaentrate.gov.it:specificheTecniche:sco:730

children	<a href="#">m730:NonVersare</a> <a href="#">m730:ImportoDaTrattenere</a>
----------	--

### element **Debito\_Type/NonVersare**

diagram	
namespace	urn:www.agenziaentrate.gov.it:specificheTecniche:sco:730
type	<a href="#">DatoNP_Type</a>
facets	Kind Value pattern [1-9]{1}[0-9]*

### element **Debito\_Type/ImportoDaTrattenere**

diagram	
namespace	urn:www.agenziaentrate.gov.it:specificheTecniche:sco:730
type	<a href="#">DatoNP_Type</a>
facets	Kind Value pattern [1-9]{1}[0-9]*

### complexType **Deduzioni\_Modulo\_Type**

diagram	
namespace	urn:www.agenziaentrate.gov.it:specificheTecniche:sco:730
children	<a href="#">m730:AssegnoConiuge</a> <a href="#">m730:AltriOneri</a> <a href="#">m730:AcquistoCostruzioneAbitLocazione</a>

### element **Deduzioni\_Modulo\_Type/AssegnoConiuge**

diagram	
namespace	urn:www.agenziaentrate.gov.it:specificheTecniche:sco:730
type	<a href="#">m730:Assegno Coniuge_Type</a>
children	<a href="#">m730:CodiceFiscale</a> <a href="#">m730:Importo</a>

element **Deduzioni\_Modulo\_Type/AltriOneri**

diagram	
namespace	urn:www.agenziaentrate.gov.it:specificheTecniche:sco:730
type	<a href="#">m730:Altri_Oneri_Type</a>
children	<a href="#">m730:Codice</a> <a href="#">m730:Importo</a>

element **Deduzioni\_Modulo\_Type/AcquistoCostruzioneAbitLocazione**

diagram	
namespace	urn:www.agenziaentrate.gov.it:specificheTecniche:sco:730
type	<a href="#">m730:Acquisto_Costruzione_Abit_Type</a>
children	<a href="#">m730:DataStipula</a> <a href="#">m730:Spesa</a> <a href="#">m730:InteressiMutuo</a>

complexType **Deduzioni\_Type**

diagram	
namespace	urn:www.agenziaentrate.gov.it:specificheTecniche:sco:730
children	<a href="#">m730:ContributiPrevAss</a> <a href="#">m730:AssegnoConiuge</a> <a href="#">m730:ContributiColf</a> <a href="#">m730:ErogazioniIstituzioniReligiose</a> <a href="#">m730:SpesePortatoriHandicap</a> <a href="#">m730:AltriOneri</a> <a href="#">m730:DeducibilitaOrdinaria</a> <a href="#">m730:LavoratoriPrimaOccupazione</a> <a href="#">m730:FondiInSquilibrioFinanziario</a> <a href="#">m730:FamiliariACarico</a> <a href="#">m730:FondoPensioneDipendentiPubblici</a> <a href="#">m730:AcquistoCostruzioneAbitLocazione</a> <a href="#">m730:RestituzioneSomme</a>

element **Deduzioni\_Type/ContributiPrevAss**

diagram					
namespace	urn:www.agenziaentrate.gov.it:specificheTecniche:sco:730				
type	<a href="#">DatoNP_Type</a>				
facets	<table border="1"> <tr> <td>Kind</td> <td>Value</td> </tr> <tr> <td>pattern</td> <td>[1-9]{1}[0-9]*</td> </tr> </table>	Kind	Value	pattern	[1-9]{1}[0-9]*
Kind	Value				
pattern	[1-9]{1}[0-9]*				

element **Deduzioni\_Type/AssegnoConiuge**

diagram	
namespace	urn:www.agenziaentrate.gov.it:specificheTecniche:sco:730
type	<a href="#">m730:Assegno_Coniuge_Type</a>
children	<a href="#">m730:CodiceFiscale</a> <a href="#">m730:Importo</a>

element **Deduzioni\_Type/ContributiColf**

diagram					
namespace	urn:www.agenziaentrate.gov.it:specificheTecniche:sco:730				
type	<a href="#">DatoNP_Type</a>				
facets	<table border="1"> <tr> <td>Kind</td> <td>Value</td> </tr> <tr> <td>pattern</td> <td>[1-9]{1}[0-9]*</td> </tr> </table>	Kind	Value	pattern	[1-9]{1}[0-9]*
Kind	Value				
pattern	[1-9]{1}[0-9]*				

element **Deduzioni\_Type/ErogazioniIstituzioniReligiose**

diagram					
namespace	urn:www.agenziaentrate.gov.it:specificheTecniche:sco:730				
type	<a href="#">DatoNP_Type</a>				
facets	<table border="1"> <tr> <td>Kind</td> <td>Value</td> </tr> <tr> <td>pattern</td> <td>[1-9]{1}[0-9]*</td> </tr> </table>	Kind	Value	pattern	[1-9]{1}[0-9]*
Kind	Value				
pattern	[1-9]{1}[0-9]*				

element **Deduzioni\_Type/SpesePortatoriHandicap**

diagram					
namespace	urn:www.agenziaentrate.gov.it:specificheTecniche:sco:730				
type	<a href="#">DatoNP_Type</a>				
facets	<table border="1"> <tr> <td>Kind</td> <td>Value</td> </tr> <tr> <td>pattern</td> <td>[1-9]{1}[0-9]*</td> </tr> </table>	Kind	Value	pattern	[1-9]{1}[0-9]*
Kind	Value				
pattern	[1-9]{1}[0-9]*				



element **Deduzioni\_Type/AltriOneri**

diagram	<p>The diagram shows a dashed box labeled 'm730:AltriOneri' connected to a solid box labeled 'm730:Altri_Oneri_Type'. Inside the solid box, there are two sub-elements: 'm730:Codice' and 'm730:Importo'.</p>
namespace	urn:www.agenziaentrate.gov.it:specificheTecniche:sco:730
type	<a href="#">m730:Altri_Oneri_Type</a>
children	<a href="#">m730:Codice</a> <a href="#">m730:Importo</a>

element **Deduzioni\_Type/DeducibilitaOrdinaria**

diagram	<p>The diagram shows a dashed box labeled 'm730:DeducibilitaOrdinaria' connected to a solid box labeled 'm730:Contributi_Previdenza_Complementare_Type'. Inside the solid box, there are two sub-elements: 'm730:EsclusiDalSostituto' and 'm730:NonEsclusiDalSostituto'.</p>
namespace	urn:www.agenziaentrate.gov.it:specificheTecniche:sco:730
type	<a href="#">m730:Contributi_Previdenza_Complementare_Type</a>
children	<a href="#">m730:EsclusiDalSostituto</a> <a href="#">m730:NonEsclusiDalSostituto</a>

element **Deduzioni\_Type/LavoratoriPrimaOccupazione**

diagram	<p>The diagram shows a dashed box labeled 'm730:LavoratoriPrimaOccupazi...' connected to a solid box labeled 'm730:Contributi_Previdenza_Complementare_Type'. Inside the solid box, there are two sub-elements: 'm730:EsclusiDalSostituto' and 'm730:NonEsclusiDalSostituto'.</p>
namespace	urn:www.agenziaentrate.gov.it:specificheTecniche:sco:730
type	<a href="#">m730:Contributi_Previdenza_Complementare_Type</a>
children	<a href="#">m730:EsclusiDalSostituto</a> <a href="#">m730:NonEsclusiDalSostituto</a>

element **Deduzioni\_Type/FondiInSquilibrioFinanziario**

diagram	
namespace	urn:www.agenziaentrate.gov.it:specificheTecniche:sco:730
type	<a href="#">m730:Contributi Previdenza Complementare Type</a>
children	<a href="#">m730:EsclusiDalSostituto</a> <a href="#">m730:NonEsclusiDalSostituto</a>

element **Deduzioni\_Type/FamiliariACarico**

diagram	
namespace	urn:www.agenziaentrate.gov.it:specificheTecniche:sco:730
type	<a href="#">m730:Contributi Previdenza Complementare Type</a>
children	<a href="#">m730:EsclusiDalSostituto</a> <a href="#">m730:NonEsclusiDalSostituto</a>

element **Deduzioni\_Type/FondoPensioneDipendentiPubblici**

diagram	
namespace	urn:www.agenziaentrate.gov.it:specificheTecniche:sco:730
type	<a href="#">m730:Fondo_Pensione_Dipendenti_Pubblici_Type</a>
children	<a href="#">m730:Contributi</a> <a href="#">m730:QuotaTFR</a>

element **Deduzioni\_Type/AcquistoCostruzioneAbitLocazione**

diagram	
namespace	urn:www.agenziaentrate.gov.it:specificheTecniche:sco:730
type	<a href="#">m730:Acquisto_Costruzione_Abit_Type</a>
children	<a href="#">m730:DataStipula</a> <a href="#">m730:Spesa</a> <a href="#">m730:InteressiMutuo</a>

element **Deduzioni\_Type/RestituzioneSomme**

diagram	
namespace	urn:www.agenziaentrate.gov.it:specificheTecniche:sco:730
type	<a href="#">m730:Restituzione_Somme_Type</a>
children	<a href="#">m730:SommeRestituite</a> <a href="#">m730:ResiduoPrecedenteDic</a>

complexType **Detrazione\_Crediti\_Type**

<p>diagram</p>	
<p>namespace</p>	<p>urn:www.agenziaentrate.gov.it:specificheTecniche:sco:730</p>
<p>children</p>	<p><a href="#">m730:DetrazioneConiuge</a> <a href="#">m730:DetrazioneFigli</a> <a href="#">m730:UlterioreDetrazioneFigli</a> <a href="#">m730:DetrazioneFamiliari</a> <a href="#">m730:DetrazioneLavDip</a> <a href="#">m730:DetrazionePens</a> <a href="#">m730:DetrazioneAltriRedditi</a> <a href="#">m730:DetrazioneOneri</a> <a href="#">m730:DetrazioneRistrutturazione</a> <a href="#">m730:DetrazioniArredolmmobili</a> <a href="#">m730:DetrazioneRisparmioEnergetico</a> <a href="#">m730:DetrazioneArredoGiovaniCoppie</a> <a href="#">m730:DetrazionelvaAcquistoAbitaz</a> <a href="#">m730:DetrazioneLocEAgricoliGiovani</a> <a href="#">m730:AltreDetrazioni</a> <a href="#">m730:CreditoPrimaCasa</a> <a href="#">m730:CreditoOccupazione</a> <a href="#">m730:CreditoFondiPensione</a> <a href="#">m730:CreditoMediazioni</a> <a href="#">m730:CreditoNegoziazione</a> <a href="#">m730:TotaleDetrazioniCrediti</a></p>

element **Detrazione\_Crediti\_Type/DetrazioneConiuge**

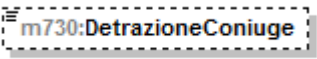
diagram	
namespace	urn:www.agenziaentrate.gov.it:specificheTecniche:sco:730
type	<a href="#">DatoNP_Type</a>
facets	Kind Value pattern [1-9]{1}[0-9]*

element **Detrazione\_Crediti\_Type/DetrazioneFigli**

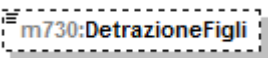
diagram	
namespace	urn:www.agenziaentrate.gov.it:specificheTecniche:sco:730
type	<a href="#">DatoNP_Type</a>
facets	Kind Value pattern [1-9]{1}[0-9]*

element **Detrazione\_Crediti\_Type/UlterioreDetrazioneFigli**

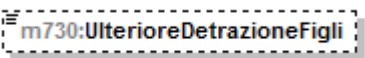
diagram	
namespace	urn:www.agenziaentrate.gov.it:specificheTecniche:sco:730
type	<a href="#">DatoNP_Type</a>
facets	Kind Value pattern [1-9]{1}[0-9]*

element **Detrazione\_Crediti\_Type/DetrazioneFamiliari**

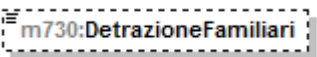
diagram	
namespace	urn:www.agenziaentrate.gov.it:specificheTecniche:sco:730
type	<a href="#">DatoNP_Type</a>
facets	Kind Value pattern [1-9]{1}[0-9]*

element **Detrazione\_Crediti\_Type/DetrazioneLavDip**

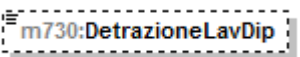
diagram	
namespace	urn:www.agenziaentrate.gov.it:specificheTecniche:sco:730
type	<a href="#">DatoNP_Type</a>

facets	Kind pattern	Value [1-9]{1}[0-9]*
--------	-----------------	-------------------------

#### element **Detrazione\_Crediti\_Type/DetrazionePens**

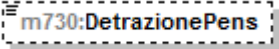
diagram		
namespace	urn:www.agenziaentrate.gov.it:specificheTecniche:sco:730	
type	<a href="#">DatoNP_Type</a>	
facets	Kind pattern	Value [1-9]{1}[0-9]*

#### element **Detrazione\_Crediti\_Type/DetrazioneAltriRedditi**

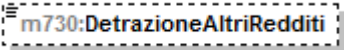
diagram		
namespace	urn:www.agenziaentrate.gov.it:specificheTecniche:sco:730	
type	<a href="#">DatoNP_Type</a>	
facets	Kind pattern	Value [1-9]{1}[0-9]*

#### element **Detrazione\_Crediti\_Type/DetrazioneOneri**

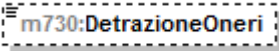
diagram		
namespace	urn:www.agenziaentrate.gov.it:specificheTecniche:sco:730	
type	<a href="#">DatoNP_Type</a>	
facets	Kind pattern	Value [1-9]{1}[0-9]*

#### element **Detrazione\_Crediti\_Type/DetrazioneRistrutturazione**

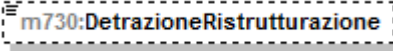
diagram		
namespace	urn:www.agenziaentrate.gov.it:specificheTecniche:sco:730	
type	<a href="#">DatoNP_Type</a>	
facets	Kind pattern	Value [1-9]{1}[0-9]*

#### element **Detrazione\_Crediti\_Type/DetrazioniArredolImmobili**

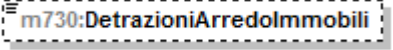
diagram		
namespace	urn:www.agenziaentrate.gov.it:specificheTecniche:sco:730	

type	<a href="#">DatoNP_Type</a>
facets	Kind Value pattern [1-9]{1}[0-9]*

element **Detrazione\_Crediti\_Type/DetrazioneRisparmioEnergetico**

diagram	
namespace	urn:www.agenziaentrate.gov.it:specificheTecniche:sco:730
type	<a href="#">DatoNP_Type</a>
facets	Kind Value pattern [1-9]{1}[0-9]*

element **Detrazione\_Crediti\_Type/DetrazioneArredoGiovaniCoppie**

diagram	
namespace	urn:www.agenziaentrate.gov.it:specificheTecniche:sco:730
type	<a href="#">DatoNP_Type</a>
facets	Kind Value pattern [1-9]{1}[0-9]*

element **Detrazione\_Crediti\_Type/DetrazioneIvaAcquistoAbitaz**

diagram	
namespace	urn:www.agenziaentrate.gov.it:specificheTecniche:sco:730
type	<a href="#">DatoNP_Type</a>
facets	Kind Value pattern [1-9]{1}[0-9]*

element **Detrazione\_Crediti\_Type/DetrazioneLocEAgricoliGiovani**

diagram	
namespace	urn:www.agenziaentrate.gov.it:specificheTecniche:sco:730
type	<a href="#">DatoNP_Type</a>
facets	Kind Value pattern [1-9]{1}[0-9]*

element **Detrazione\_Crediti\_Type/AltreDetrazioni**

diagram	
---------	--

namespace	urn:www.agenziaentrate.gov.it:specificheTecniche:sco:730
type	<a href="#">DatoNP_Type</a>
facets	Kind Value pattern [1-9]{1}[0-9]*

#### element **Detrazione\_Crediti\_Type/CreditoPrimaCasa**

diagram	
namespace	urn:www.agenziaentrate.gov.it:specificheTecniche:sco:730
type	<a href="#">DatoNP_Type</a>
facets	Kind Value pattern [1-9]{1}[0-9]*

#### element **Detrazione\_Crediti\_Type/CreditoOccupazione**

diagram	
namespace	urn:www.agenziaentrate.gov.it:specificheTecniche:sco:730
type	<a href="#">DatoNP_Type</a>
facets	Kind Value pattern [1-9]{1}[0-9]*

#### element **Detrazione\_Crediti\_Type/CreditoFondiPensione**

diagram	
namespace	urn:www.agenziaentrate.gov.it:specificheTecniche:sco:730
type	<a href="#">DatoNP_Type</a>
facets	Kind Value pattern [1-9]{1}[0-9]*

#### element **Detrazione\_Crediti\_Type/CreditoMediazioni**

diagram	
namespace	urn:www.agenziaentrate.gov.it:specificheTecniche:sco:730
type	<a href="#">DatoNP_Type</a>
facets	Kind Value pattern [1-9]{1}[0-9]*



element **Detrazione\_Crediti\_Type/CreditoNegoziazione**

diagram	
namespace	urn:www.agenziaentrate.gov.it:specificheTecniche:sco:730
type	<a href="#">DatoNP_Type</a>
facets	Kind Value pattern [1-9]{1}[0-9]*

element **Detrazione\_Crediti\_Type/TotaleDetrazioniCrediti**

diagram	
namespace	urn:www.agenziaentrate.gov.it:specificheTecniche:sco:730
type	<a href="#">DatoNP_Type</a>
facets	Kind Value pattern [1-9]{1}[0-9]*

complexType **Detrazioni\_Canoni\_Locazione\_Type**

diagram	
namespace	urn:www.agenziaentrate.gov.it:specificheTecniche:sco:730
children	<a href="#">m730:InquiliniAbitazionePrincipale</a> <a href="#">m730:DipendentiTrasferiti</a>

element **Detrazioni\_Canoni\_Locazione\_Type/InquiliniAbitazionePrincipale**

diagram	
namespace	urn:www.agenziaentrate.gov.it:specificheTecniche:sco:730
type	<a href="#">m730:Inquilini_Abitazione_Principale_Type</a>
children	<a href="#">m730:Tipologia</a> <a href="#">m730:GiorniPercentuale</a>

element **Detrazioni\_Canoni\_Locazione\_Type/DipendentiTrasferiti**

diagram	
namespace	urn:www.agenziaentrate.gov.it:specificheTecniche:sco:730
type	<a href="#">m730:Giorni_Percentuale_Type</a>
children	<a href="#">m730:Giorni</a> <a href="#">m730:Percentuale</a>

complexType **Detrazioni\_Modulo\_Type**

diagram	
namespace	urn:www.agenziaentrate.gov.it:specificheTecniche:sco:730
children	<a href="#">m730:VeicoliDisabili</a> <a href="#">m730:AcquistoCaniGuida</a> <a href="#">m730:SpeseRateizzate</a> <a href="#">m730:AltreSpese</a> <a href="#">m730:SpeseLeasing</a>

element **Detrazioni\_Modulo\_Type/VeicoliDisabili**

diagram	
namespace	urn:www.agenziaentrate.gov.it:specificheTecniche:sco:730
type	<a href="#">m730:Spese_Rateizzate_Type</a>
children	<a href="#">m730:Codice</a> <a href="#">m730:Importo</a>

element **Detrazioni\_Modulo\_Type/AcquistoCaniGuida**

diagram	
namespace	urn:www.agenziaentrate.gov.it:specificheTecniche:sco:730
type	<a href="#">m730:Spese_Rateizzate_Type</a>
children	<a href="#">m730:Codice</a> <a href="#">m730:Importo</a>

element **Detrazioni\_Modulo\_Type/SpeseRateizzate**

diagram	
namespace	urn:www.agenziaentrate.gov.it:specificheTecniche:sco:730
type	<a href="#">m730:Spese_Rateizzate_Anni_Precedenti_Type</a>
children	<a href="#">m730:Codice</a> <a href="#">m730:Importo</a>

element **Detrazioni\_Modulo\_Type/AltreSpese**

diagram	
namespace	urn:www.agenziaentrate.gov.it:specificheTecniche:sco:730
type	<a href="#">m730:Altre_Spese_Type</a>
children	<a href="#">m730:Codice</a> <a href="#">m730:Importo</a>

element **Detrazioni\_Modulo\_Type/SpeseLeasing**

diagram	
namespace	urn:www.agenziaentrate.gov.it:specificheTecniche:sco:730
type	<a href="#">m730:Spese_Leasing_Type</a>
children	<a href="#">m730:DataStipula</a> <a href="#">m730:NumeroAnno</a> <a href="#">m730:Canone</a> <a href="#">m730:PrezzoRiscatto</a>

complexType **Detrazioni\_Type**

diagram	
namespace	urn:www.agenziaentrate.gov.it:specificheTecniche:sco:730
children	<a href="#">m730:CasellaRateazione</a> <a href="#">m730:SpeseDeterminatePatologie</a> <a href="#">m730:SpeseSanitarie</a> <a href="#">m730:SpeseFamNonACarico</a> <a href="#">m730:SpeseSanitarieDisabili</a> <a href="#">m730:VeicoliDisabili</a> <a href="#">m730:AcquistoCaniGuida</a> <a href="#">m730:SpeseRateizzate</a> <a href="#">m730:MutuiAbPrincipale</a> <a href="#">m730:AltreSpese</a> <a href="#">m730:SpeseLeasing</a>

element **Detrazioni\_Type/CasellaRateazione**

diagram	 <b>m730:CasellaRateazione</b>
namespace	urn:www.agenziaentrate.gov.it:specificheTecniche:sco:730
type	<a href="#">DatoCB_Type</a>
facets	Kind Value pattern [01]

element **Detrazioni\_Type/SpeseDeterminatePatologie**

diagram	 <b>m730:SpeseDeterminatePatologie</b>
namespace	urn:www.agenziaentrate.gov.it:specificheTecniche:sco:730
type	<a href="#">DatoNP_Type</a>
facets	Kind Value pattern [1-9]{1}[0-9]*

element **Detrazioni\_Type/SpeseSanitarie**

diagram	 <b>m730:Spese Sanitarie</b>
namespace	urn:www.agenziaentrate.gov.it:specificheTecniche:sco:730
type	<a href="#">DatoNP_Type</a>
facets	Kind Value pattern [1-9]{1}[0-9]*

element **Detrazioni\_Type/SpeseFamNonACarico**

diagram	 <b>m730:SpeseFamNonACarico</b>
namespace	urn:www.agenziaentrate.gov.it:specificheTecniche:sco:730
type	<a href="#">DatoNP_Type</a>
facets	Kind Value pattern [1-9]{1}[0-9]*

element **Detrazioni\_Type/SpeseSanitarieDisabili**

diagram	 <b>m730:Spese SanitarieDisabili</b>
namespace	urn:www.agenziaentrate.gov.it:specificheTecniche:sco:730
type	<a href="#">DatoNP_Type</a>
facets	Kind Value pattern [1-9]{1}[0-9]*

element **Detrazioni\_Type/VeicoliDisabili**

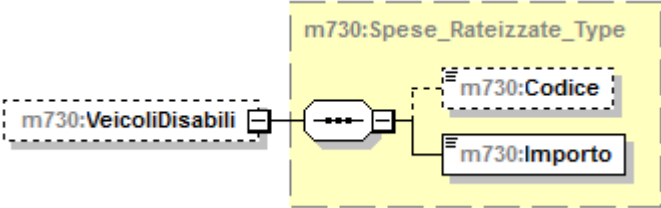
diagram	
namespace	urn:www.agenziaentrate.gov.it:specificheTecniche:sco:730
type	<a href="#">m730:Spese_Rateizzate_Type</a>
children	<a href="#">m730:Codice</a> <a href="#">m730:Importo</a>

element **Detrazioni\_Type/AcquistoCaniGuida**

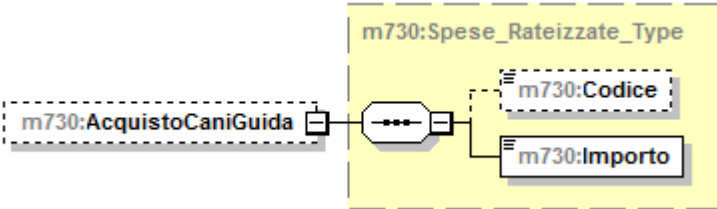
diagram	
namespace	urn:www.agenziaentrate.gov.it:specificheTecniche:sco:730
type	<a href="#">m730:Spese_Rateizzate_Type</a>
children	<a href="#">m730:Codice</a> <a href="#">m730:Importo</a>

element **Detrazioni\_Type/SpeseRateizzate**

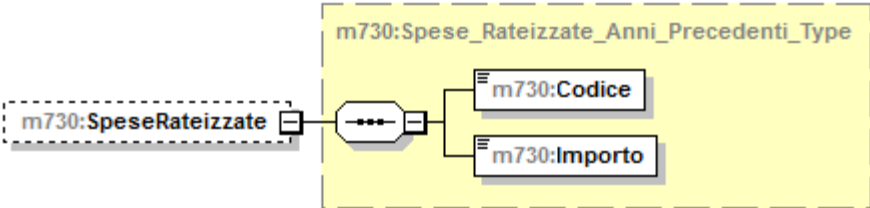
diagram	
namespace	urn:www.agenziaentrate.gov.it:specificheTecniche:sco:730
type	<a href="#">m730:Spese_Rateizzate_Anni_Precedenti_Type</a>
children	<a href="#">m730:Codice</a> <a href="#">m730:Importo</a>

element **Detrazioni\_Type/MutuiAbPrincipale**

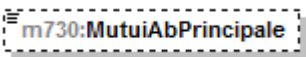
diagram	
namespace	urn:www.agenziaentrate.gov.it:specificheTecniche:sco:730

type	<a href="#">DatoNP_Type</a>	
facets	Kind	Value
	pattern	[1-9]{1}[0-9]*

### element **Detrazioni\_Type/AltreSpese**

diagram		
namespace	urn:www.agenziaentrate.gov.it:specificheTecniche:sco:730	
type	<a href="#">m730:Altre Spese_Type</a>	
children	<a href="#">m730:Codice</a> <a href="#">m730:Importo</a>	

### element **Detrazioni\_Type/SpeseLeasing**

diagram		
namespace	urn:www.agenziaentrate.gov.it:specificheTecniche:sco:730	
type	<a href="#">m730:Spese Leasing_Type</a>	
children	<a href="#">m730:DataStipula</a> <a href="#">m730:NumeroAnno</a> <a href="#">m730:Canone</a> <a href="#">m730:PrezzoRiscatto</a>	

### complexType **Dichiarazione\_Con\_Type**

diagram		
namespace	urn:www.agenziaentrate.gov.it:specificheTecniche:sco:730	

children	<a href="#">m730:Frontespizio</a> <a href="#">m730:DatiContabili</a> <a href="#">m730:FuoriAssistenzaQuadri</a> <a href="#">m730:Scelte</a>
----------	---

element **Dichiarazione\_Con\_Type/Frontespizio**

diagram	
namespace	urn:www.agenziaentrate.gov.it:specificheTecniche:sco:730
type	<a href="#">m730:Frontespizio_Con_Type</a>
children	<a href="#">m730:SoggettoFiscale</a> <a href="#">m730:DatiAnagrafici</a> <a href="#">m730:StatoCivile</a> <a href="#">m730:ResidenzaAnagrafica</a> <a href="#">m730:DomicilioFiscaleSaldo</a> <a href="#">m730:DomicilioFiscaleAcconto</a> <a href="#">m730:CasiParticolariAddizionale</a> <a href="#">m730:Firma</a>



element **Dichiarazione\_Con\_Type/DatiContabili**

<p>diagram</p>	
<p>namespace</p>	<p>urn:www.agenziaentrate.gov.it:specificheTecniche:sco:730</p>
<p>type</p>	<p><a href="#">m730:Dati_Contabili_Type</a></p>
<p>children</p>	<p><a href="#">m730:Familiari</a> <a href="#">m730:QuadroA</a> <a href="#">m730:QuadroB</a> <a href="#">m730:QuadroC</a> <a href="#">m730:QuadroD</a> <a href="#">m730:QuadroE</a> <a href="#">m730:QuadroF</a> <a href="#">m730:QuadroG</a> <a href="#">m730:QuadroI</a> <a href="#">m730:ProspettoLiquidazione</a> <a href="#">m730:Prospetto_Annotazioni</a> <a href="#">m730:QuadroK</a></p>

element **Dichiarazione\_Con\_Type/FuoriAssistenzaQuadri**

diagram	
namespace	urn:www.agenziaentrate.gov.it:specificheTecniche:sco:730
type	<a href="#">m730:Fuori_Assistenza_Type</a>
children	<a href="#">m730:AnomaliaDatianagrafici</a> <a href="#">m730:AnomaliaTerreni</a> <a href="#">m730:AnomaliaFabbricati</a> <a href="#">m730:AnomaliaLavDip</a> <a href="#">m730:AnomaliaAltriRedditi</a> <a href="#">m730:AnomaliaQuadroF</a>

element **Dichiarazione\_Con\_Type/Scelte**

diagram	
namespace	urn:www.agenziaentrate.gov.it:specificheTecniche:sco:730
type	<a href="#">sce:Scelte_Type</a>
children	<a href="#">sce:Scelta5PerMille</a> <a href="#">sce:Scelta8PerMille</a> <a href="#">sce:Scelta2PerMille</a>

complexType **Dichiarazione\_Dich\_Type**

diagram	
---------	--

namespace	urn:www.agenziaentrate.gov.it:specificheTecniche:sco:730
children	<a href="#">m730:Frontespizio</a> <a href="#">m730:DatiContabili</a> <a href="#">m730:FuoriAssistenza</a> <a href="#">m730:Scelte</a>

element **Dichiarazione\_Dich\_Type/**Frontespizio

diagram	<pre> classDiagram     class m730Frontespizio     class m730Frontespizio_Dich_Type["m730:Frontespizio_Dich_Type (extension)"]     class m730SoggettoFiscale     class m730DatiAnagrafici     class m730StatoCivile     class m730ResidenzaAnagrafica     class m730DomicilioFiscale_Saldo["m730:DomicilioFiscale Saldo"]     class m730DomicilioFiscale_Acconto["m730:DomicilioFiscaleAcconto"]     class m730CasiParticolariAddizionale     class m730Firma     class m730Rappresentante      m730Frontespizio_Dich_Type -- &gt; m730Frontespizio     m730Frontespizio_Dich_Type -- m730SoggettoFiscale     m730Frontespizio_Dich_Type -- m730DatiAnagrafici     m730Frontespizio_Dich_Type -- m730StatoCivile     m730Frontespizio_Dich_Type -- m730ResidenzaAnagrafica     m730Frontespizio_Dich_Type -- m730DomicilioFiscale_Saldo     m730Frontespizio_Dich_Type -- m730DomicilioFiscale_Acconto     m730Frontespizio_Dich_Type -- m730CasiParticolariAddizionale     m730Frontespizio_Dich_Type -- m730Firma     m730Frontespizio_Dich_Type -- m730Rappresentante     </pre>
namespace	urn:www.agenziaentrate.gov.it:specificheTecniche:sco:730
type	extension of <a href="#">m730:Frontespizio Dich_Type</a>
children	<a href="#">m730:SoggettoFiscale</a> <a href="#">m730:DatiAnagrafici</a> <a href="#">m730:StatoCivile</a> <a href="#">m730:ResidenzaAnagrafica</a> <a href="#">m730:DomicilioFiscaleSaldo</a> <a href="#">m730:DomicilioFiscaleAcconto</a> <a href="#">m730:CasiParticolariAddizionale</a> <a href="#">m730:Firma</a> <a href="#">m730:Rappresentante</a>

element **Dichiarazione\_Dich\_Type/DatiContabili**

<p>diagram</p>	
<p>namespace</p>	<p>urn:www.agenziaentrate.gov.it:specificheTecniche:sco:730</p>
<p>type</p>	<p><a href="#">m730:Dati_Contabili_Type</a></p>
<p>children</p>	<p><a href="#">m730:Familiari</a> <a href="#">m730:QuadroA</a> <a href="#">m730:QuadroB</a> <a href="#">m730:QuadroC</a> <a href="#">m730:QuadroD</a> <a href="#">m730:QuadroE</a> <a href="#">m730:QuadroF</a> <a href="#">m730:QuadroG</a> <a href="#">m730:QuadroI</a> <a href="#">m730:ProspettoLiquidazione</a> <a href="#">m730:Prospetto_Annotazioni</a> <a href="#">m730:QuadroK</a></p>

element **Dichiarazione\_Dich\_Type/FuoriAssistenza**

<p>diagram</p>	
<p>namespace</p>	<p>urn:www.agenziaentrate.gov.it:specificheTecniche:sco:730</p>
<p>children</p>	<p><a href="#">m730:FuoriAssistenzaQuadri</a> <a href="#">m730:AnomaliaDatiSostituto</a> <a href="#">m730:AnomaliaDatiRappresentante</a></p>

element **Dichiarazione\_Dich\_Type/FuoriAssistenza/FuoriAssistenzaQuadri**

diagram	<p>The diagram illustrates the structure of the <code>m730:FuoriAssistenzaQuadri</code> element. It is composed of a <code>m730:Fuori_Assistenza_Type</code> container (highlighted in yellow) and a sequence of sub-elements. The sub-elements are: <code>m730:AnomaliaDatianagrafici</code>, <code>m730:AnomaliaTerreni</code>, <code>m730:AnomaliaFabbricati</code>, <code>m730:AnomaliaLavDip</code>, <code>m730:AnomaliaAltriRedditi</code>, and <code>m730:AnomaliaQuadroF</code>. The <code>m730:FuoriAssistenzaQuadri</code> element is shown as a dashed box containing a solid box with a small square on its right side, which is connected to the <code>m730:Fuori_Assistenza_Type</code> container. The container is connected to a sequence of sub-elements, each represented by a dashed box with a small square on its left side.</p>
namespace	urn:www.agenziaentrate.gov.it:specificheTecniche:sco:730
type	<a href="#">m730:Fuori_Assistenza_Type</a>
children	<a href="#">m730:AnomaliaDatianagrafici</a> <a href="#">m730:AnomaliaTerreni</a> <a href="#">m730:AnomaliaFabbricati</a> <a href="#">m730:AnomaliaLavDip</a> <a href="#">m730:AnomaliaAltriRedditi</a> <a href="#">m730:AnomaliaQuadroF</a>

element **Dichiarazione\_Dich\_Type/FuoriAssistenza/AnomaliaDatiSostituto**

diagram	<p>The diagram shows the <code>m730:AnomaliaDatiSostituto</code> element as a dashed box with a small square on its left side.</p>				
namespace	urn:www.agenziaentrate.gov.it:specificheTecniche:sco:730				
type	<a href="#">DatoCB_Type</a>				
facets	<table border="1"> <thead> <tr> <th>Kind</th> <th>Value</th> </tr> </thead> <tbody> <tr> <td>pattern</td> <td>[01]</td> </tr> </tbody> </table>	Kind	Value	pattern	[01]
Kind	Value				
pattern	[01]				

element **Dichiarazione\_Dich\_Type/FuoriAssistenza/AnomaliaDatiRappresentante**

diagram	<p>The diagram shows the <code>m730:AnomaliaDatiRappresentante</code> element as a dashed box with a small square on its left side.</p>				
namespace	urn:www.agenziaentrate.gov.it:specificheTecniche:sco:730				
type	<a href="#">DatoCB_Type</a>				
facets	<table border="1"> <thead> <tr> <th>Kind</th> <th>Value</th> </tr> </thead> <tbody> <tr> <td>pattern</td> <td>[01]</td> </tr> </tbody> </table>	Kind	Value	pattern	[01]
Kind	Value				
pattern	[01]				

element **Dichiarazione\_Dich\_Type/Scelte**

diagram	
namespace	urn:www.agenziaentrate.gov.it:specificheTecniche:sco:730
type	<a href="#">sce:Scelte_Type</a>
children	<a href="#">sce:Scelta5PerMille</a> <a href="#">sce:Scelta8PerMille</a> <a href="#">sce:Scelta2PerMille</a>

complexType **Documento\_730-4**

diagram	
namespace	urn:www.agenziaentrate.gov.it:specificheTecniche:sco:730
children	<a href="#">m730:DatiAnagraficiDichiarante</a> <a href="#">m730:Sostituto</a> <a href="#">m730:SoggettoAssFiscale730-4</a> <a href="#">m730:AltriDati</a> <a href="#">m730:DatiContabili730-4</a>

element Documento\_730-4/DatiAnagraficiDichiarante

diagram	
namespace	urn:www.agenziaentrate.gov.it:specificheTecniche:sco:730
type	extension of <a href="#">Dati_Anagrafici_Type</a>
children	<a href="#">Cognome</a> <a href="#">Nome</a> <a href="#">Sesso</a> <a href="#">DataNascita</a> <a href="#">ComuneNascita</a> <a href="#">ProvinciaNascita</a> <a href="#">m730:CFDichiarante</a>

element Documento\_730-4/DatiAnagraficiDichiarante/CFDichiarante

diagram					
namespace	urn:www.agenziaentrate.gov.it:specificheTecniche:sco:730				
type	<a href="#">DatoCF_Type</a>				
facets	<table border="1"> <thead> <tr> <th>Kind</th> <th>Value</th> </tr> </thead> <tbody> <tr> <td>pattern</td> <td>[0-9]{11}[A-Z]{6}[0-9LMNPQRSTU]{2}[A-Z]{1}[0-9LMNPQRSTU]{2}[A-Z]{1}[0-9LMNPQRSTU]{3}[A-Z]{1}</td> </tr> </tbody> </table>	Kind	Value	pattern	[0-9]{11}[A-Z]{6}[0-9LMNPQRSTU]{2}[A-Z]{1}[0-9LMNPQRSTU]{2}[A-Z]{1}[0-9LMNPQRSTU]{3}[A-Z]{1}
Kind	Value				
pattern	[0-9]{11}[A-Z]{6}[0-9LMNPQRSTU]{2}[A-Z]{1}[0-9LMNPQRSTU]{2}[A-Z]{1}[0-9LMNPQRSTU]{3}[A-Z]{1}				

element **Documento\_730-4/Sostituto**

diagram	
namespace	urn:www.agenziaentrate.gov.it:specificheTecniche:sco:730
type	<a href="#">m730:Sostituto_Type</a>
children	<a href="#">m730:CodiceFiscale</a> <a href="#">m730:DatiAnagraficiPF</a> <a href="#">m730:DenominazionePNF</a> <a href="#">m730:Residenza</a> <a href="#">m730:Fax</a> <a href="#">m730:CodiceSede</a>

element **Documento\_730-4/SoggettoAssFiscale730-4**

diagram	
namespace	urn:www.agenziaentrate.gov.it:specificheTecniche:sco:730
children	<a href="#">m730:DatiCaf730-4</a> <a href="#">m730:DatiProfessionista730-4</a> <a href="#">m730:DatiAssociazione730-4</a> <a href="#">m730:DatiAgenzia730-4</a> <a href="#">m730:CasellaSostituto</a>



element **Documento\_730-4/SoggettoAssFiscale730-4/DatiCaf730-4**

diagram	
namespace	urn:www.agenziaentrate.gov.it:specificheTecniche:sco:730
type	extension of <a href="#">m730:Dati_CAF_Type</a>
children	<a href="#">m730:CFCaf</a> <a href="#">m730:DenominazioneCaf</a> <a href="#">m730:NumeroAlbo</a> <a href="#">m730:DomicilioCaf</a> <a href="#">m730:UfficioPerifericoCaf</a>

element **Documento\_730-4/SoggettoAssFiscale730-4/DatiCaf730-4/DomicilioCaf**

diagram	
namespace	urn:www.agenziaentrate.gov.it:specificheTecniche:sco:730
type	<a href="#">m730:Domicilio_Sogg_Ass_Fiscale_Type</a>
children	<a href="#">m730:Comune</a> <a href="#">m730:Provincia</a> <a href="#">m730:CodiceComune</a> <a href="#">m730:Cap</a> <a href="#">m730:Indirizzo</a> <a href="#">m730:Telefono</a> <a href="#">m730:FAX</a> <a href="#">m730:Email</a>

element **Documento\_730-4/SoggettoAssFiscale730-4/DatiCaf730-4/UfficioPerifericoCaf**

diagram	
namespace	urn:www.agenziaentrate.gov.it:specificheTecniche:sco:730
children	<a href="#">m730:DomicilioUffPeriferico</a>

element **Documento\_730-4/SoggettoAssFiscale730-4/DatiCaf730-4/UfficioPerifericoCaf/DomicilioUffPeriferico**

diagram	
namespace	urn:www.agenziaentrate.gov.it:specificheTecniche:sco:730
type	extension of <a href="#">m730:Domicilio Sogg Ass Fiscale Type</a>
children	<a href="#">m730:Comune</a> <a href="#">m730:Provincia</a> <a href="#">m730:CodiceComune</a> <a href="#">m730:Cap</a> <a href="#">m730:Indirizzo</a> <a href="#">m730:Telefono</a> <a href="#">m730:FAX</a> <a href="#">m730:Email</a> <a href="#">m730:CodiceSedePeriferica</a>

element **Documento\_730-4/SoggettoAssFiscale730-4/DatiCaf730-4/UfficioPerifericoCaf/DomicilioUffPeriferico/CodiceSedePeriferica**

diagram	
namespace	urn:www.agenziaentrate.gov.it:specificheTecniche:sco:730
type	<a href="#">DatoAN Type</a>
facets	Kind Value pattern ([0-9A-Z-] \&quot;){1}([ 0-9A-Z&amp;:] ' - \., / ^°\^\(\ \) À È Ì Ò Ù Û &quot; \ \  \+)*

element Documento\_730-4/SoggettoAssFiscale730-4/DatiProfessionista730-4

diagram	<p>The diagram shows a class <code>m730:DatiProfessionista730-4</code> extending the class <code>m730:Dati_Professionista_Type (extension)</code>. The extension includes four child elements: <code>m730:CFProfessionista</code>, <code>m730:CognomeProfessionista</code>, <code>m730:NomeProfessionista</code>, and <code>m730:DomicilioProf</code>.</p>
namespace	urn:www.agenziaentrate.gov.it:specificheTecniche:sco:730
type	extension of <a href="#">m730:Dati Professionista Type</a>
children	<a href="#">m730:CFProfessionista</a> <a href="#">m730:CognomeProfessionista</a> <a href="#">m730:NomeProfessionista</a> <a href="#">m730:DomicilioProf</a>

element Documento\_730-4/SoggettoAssFiscale730-4/DatiProfessionista730-4/DomicilioProf

diagram	<p>The diagram shows a class <code>m730:DomicilioProf</code> extending the class <code>m730:Domicilio_Sogg_Ass_Fiscale_Type</code>. The extension includes eight child elements: <code>m730:Comune</code>, <code>m730:Provincia</code>, <code>m730:CodiceComune</code>, <code>m730:Cap</code>, <code>m730:Indirizzo</code>, <code>m730:Telefono</code>, <code>m730:FAX</code>, and <code>m730:Email</code>.</p>
namespace	urn:www.agenziaentrate.gov.it:specificheTecniche:sco:730
type	<a href="#">m730:Domicilio Sogg Ass Fiscale Type</a>
children	<a href="#">m730:Comune</a> <a href="#">m730:Provincia</a> <a href="#">m730:CodiceComune</a> <a href="#">m730:Cap</a> <a href="#">m730:Indirizzo</a> <a href="#">m730:Telefono</a> <a href="#">m730:FAX</a> <a href="#">m730:Email</a>

element Documento\_730-4/SoggettoAssFiscale730-4/DatiAssociazione730-4

<p>diagram</p>	
<p>namespace</p>	<p>urn:www.agenziaentrate.gov.it:specificheTecniche:sco:730</p>
<p>type</p>	<p>extension of <a href="#">m730:Dati_Associazioni_Professionale_Type</a></p>
<p>children</p>	<p><a href="#">m730:CFAssociazione</a> <a href="#">m730:DenominazioneAssociazione</a> <a href="#">m730:CFProfessionista</a> <a href="#">m730:CognomeProfessionista</a> <a href="#">m730:NomeProfessionista</a> <a href="#">m730:DomicilioAssociazione</a></p>

element Documento\_730-4/SoggettoAssFiscale730-4/DatiAssociazione730-4/DomicilioAssociazione

<p>diagram</p>	
<p>namespace</p>	<p>urn:www.agenziaentrate.gov.it:specificheTecniche:sco:730</p>
<p>type</p>	<p><a href="#">m730:Domicilio_Sogg_Ass_Fiscale_Type</a></p>
<p>children</p>	<p><a href="#">m730:Comune</a> <a href="#">m730:Provincia</a> <a href="#">m730:CodiceComune</a> <a href="#">m730:Cap</a> <a href="#">m730:Indirizzo</a> <a href="#">m730:Telefono</a> <a href="#">m730:FAX</a> <a href="#">m730:Email</a></p>



element **Documento\_730-4/AltriDati**

diagram	
namespace	urn:www.agenziaentrate.gov.it:specificheTecniche:sco:730
children	<a href="#">m730:Rettificativo</a> <a href="#">m730:Integrativo</a> <a href="#">m730:Annullamento</a> <a href="#">m730:SpazioDisposizioneUtente</a> <a href="#">m730:SituazioniParticolari</a>

element **Documento\_730-4/AltriDati/Rettificativo**

diagram											
namespace	urn:www.agenziaentrate.gov.it:specificheTecniche:sco:730										
type	<a href="#">m730:Rettificativo_Type</a>										
facets	<table border="1"> <thead> <tr> <th>Kind</th> <th>Value</th> </tr> </thead> <tbody> <tr> <td>pattern</td> <td>[1-9]</td> </tr> <tr> <td>enumeration</td> <td>1</td> </tr> <tr> <td>enumeration</td> <td>2</td> </tr> <tr> <td>enumeration</td> <td>3</td> </tr> </tbody> </table>	Kind	Value	pattern	[1-9]	enumeration	1	enumeration	2	enumeration	3
Kind	Value										
pattern	[1-9]										
enumeration	1										
enumeration	2										
enumeration	3										

element **Documento\_730-4/AltriDati/Integrativo**

diagram											
namespace	urn:www.agenziaentrate.gov.it:specificheTecniche:sco:730										
type	<a href="#">m730:Integrativo_Type</a>										
facets	<table border="1"> <thead> <tr> <th>Kind</th> <th>Value</th> </tr> </thead> <tbody> <tr> <td>pattern</td> <td>[1-9]</td> </tr> <tr> <td>enumeration</td> <td>1</td> </tr> <tr> <td>enumeration</td> <td>2</td> </tr> <tr> <td>enumeration</td> <td>3</td> </tr> </tbody> </table>	Kind	Value	pattern	[1-9]	enumeration	1	enumeration	2	enumeration	3
Kind	Value										
pattern	[1-9]										
enumeration	1										
enumeration	2										
enumeration	3										

element **Documento\_730-4/AltriDati/Annullamento**

diagram					
namespace	urn:www.agenziaentrate.gov.it:specificheTecniche:sco:730				
type	<a href="#">DatoCB_Type</a>				
facets	<table border="1"> <thead> <tr> <th>Kind</th> <th>Value</th> </tr> </thead> <tbody> <tr> <td>pattern</td> <td>[01]</td> </tr> </tbody> </table>	Kind	Value	pattern	[01]
Kind	Value				
pattern	[01]				



element Documento\_730-4/DatiContabili730-4/Ordinario\_730-4/ImportiTrattenere

<p>diagram</p>	
<p>namespace</p>	<p>urn:www.agenziaentrate.gov.it:specificheTecniche:sco:730</p>
<p>type</p>	<p><a href="#">m730:Importi Trattenere 730-4 Type</a></p>
<p>children</p>	<p><a href="#">m730:IrpefTrattenere</a> <a href="#">m730:AddRegTrattenere</a> <a href="#">m730:AddComTrattenere</a> <a href="#">m730:IrpefPrimaRataTrattenere</a> <a href="#">m730:IrpefSecondaRataTrattenere</a> <a href="#">m730:TassSepAccontoTrattenere</a> <a href="#">m730:AddComAccontoTrattenere</a> <a href="#">m730:PremiRisultatoTrattenere</a> <a href="#">m730:CedolareTrattenere</a> <a href="#">m730:CedolarePrimaRataTrattenere</a> <a href="#">m730:CedolareSecondaRataTrattenere</a></p>

element Documento\_730-4/DatiContabili730-4/Ordinario\_730-4/ImportiRimborsare

<p>diagram</p>	
<p>namespace</p>	<p>urn:www.agenziaentrate.gov.it:specificheTecniche:sco:730</p>
<p>type</p>	<p><a href="#">m730:Importi Rimborsare 730-4 Type</a></p>



children	<a href="#">m730:IrpefRimborsare</a> <a href="#">m730:AddRegRimborsare</a> <a href="#">m730:AddComRimborsare</a> <a href="#">m730:CedolareRimborsare</a>
----------	--

element **Documento\_730-4/DatiContabili730-4/Ordinario\_730-4/Conguaglio**

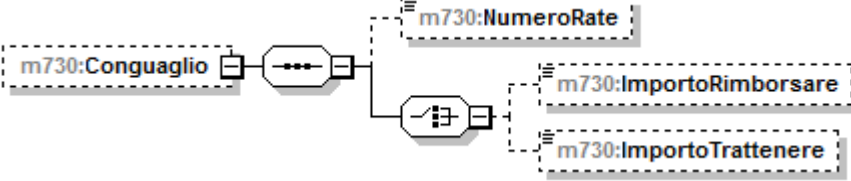
diagram	
namespace	urn:www.agenziaentrate.gov.it:specificheTecniche:sco:730
children	<a href="#">m730:NumeroRate</a> <a href="#">m730:ImportoRimborsare</a> <a href="#">m730:ImportoTrattenere</a>

element **Documento\_730-4/DatiContabili730-4/Ordinario\_730-4/Conguaglio/NumeroRate**

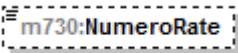
diagram	
namespace	urn:www.agenziaentrate.gov.it:specificheTecniche:sco:730
type	<a href="#">DatoN1_Type</a>
facets	Kind Value pattern [1-9]

element **Documento\_730-4/DatiContabili730-4/Ordinario\_730-4/Conguaglio/ImportoRimborsare**

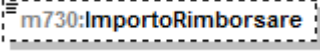
diagram	
namespace	urn:www.agenziaentrate.gov.it:specificheTecniche:sco:730
type	<a href="#">DatoNP_Type</a>
facets	Kind Value pattern [1-9]{1}[0-9]*

element **Documento\_730-4/DatiContabili730-4/Ordinario\_730-4/Conguaglio/ImportoTrattenere**

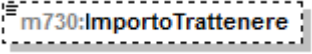
diagram	
namespace	urn:www.agenziaentrate.gov.it:specificheTecniche:sco:730
type	<a href="#">DatoNP_Type</a>
facets	Kind Value pattern [1-9]{1}[0-9]*

element **Documento\_730-4/DatiContabili730-4/Integrativo\_730-4**

diagram	
namespace	urn:www.agenziaentrate.gov.it:specificheTecniche:sco:730
children	<a href="#">m730:ImportiRimborsare</a>

element **Documento\_730-4/DatiContabili730-4/Integrativo\_730-4/ImportiRimborsare**

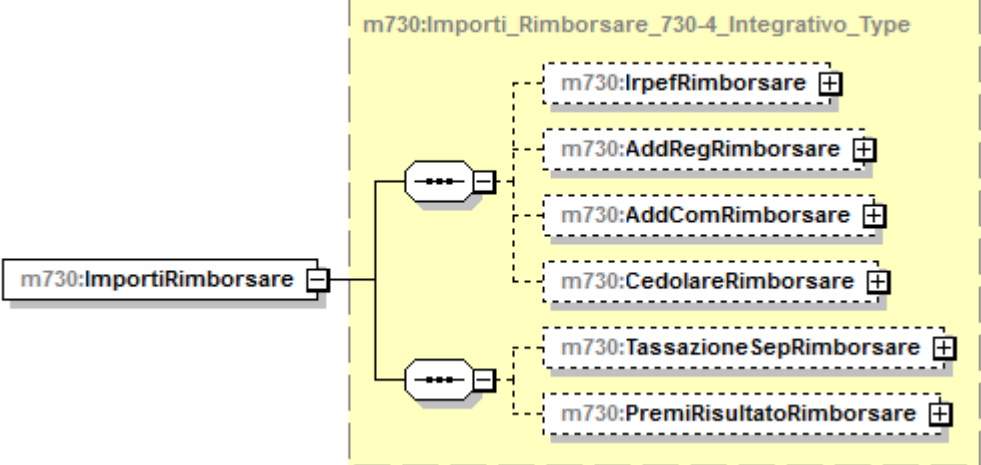
diagram	
namespace	urn:www.agenziaentrate.gov.it:specificheTecniche:sco:730
type	<a href="#">m730:Importi_Rimborsare_730-4_Integrativo_Type</a>
children	<a href="#">m730:IrpefRimborsare</a> <a href="#">m730:AddRegRimborsare</a> <a href="#">m730:AddComRimborsare</a> <a href="#">m730:CedolareRimborsare</a> <a href="#">m730:TassazioneSepRimborsare</a> <a href="#">m730:PremiRisultatoRimborsare</a>

complexType Documento\_730\_Type

diagram					
namespace	urn:www.agenziaentrate.gov.it:specificheTecniche:sco:730				
type	extension of <a href="#">Documento_Type</a>				
children	<a href="#">m730:DichiarazioneDich</a> <a href="#">m730:DichiarazioneCon</a> <a href="#">m730:AltriDati</a> <a href="#">m730:Sostituto</a> <a href="#">m730:Mod730DipendentiSenzaSostituto</a> <a href="#">m730:SoggettoAssFiscaleDoc</a> <a href="#">m730:Documento_730-4</a> <a href="#">m730:EsitiContabili</a> <a href="#">m730:DatiRettificati</a>				
attributes	Name	Type	Use	Default	Fixed
	<a href="#">identificativo</a>	<a href="#">Identificativo_Type</a>	required		

element Documento\_730\_Type/DichiarazioneDich

diagram					
namespace	urn:www.agenziaentrate.gov.it:specificheTecniche:sco:730				

type	<a href="#">m730:Dichiarazione Dich Type</a>
children	<a href="#">m730:Frontespizio</a> <a href="#">m730:DatiContabili</a> <a href="#">m730:FuoriAssistenza</a> <a href="#">m730:Scelte</a>

element **Documento\_730\_Type/DichiarazioneCon**

diagram	
namespace	urn:www.agenziaentrate.gov.it:specificheTecniche:sco:730
type	<a href="#">m730:Dichiarazione Con Type</a>
children	<a href="#">m730:Frontespizio</a> <a href="#">m730:DatiContabili</a> <a href="#">m730:FuoriAssistenzaQuadri</a> <a href="#">m730:Scelte</a>

element **Documento\_730\_Type/AltriDati**

diagram	
namespace	urn:www.agenziaentrate.gov.it:specificheTecniche:sco:730

children	<a href="#">m730:FlagConferma</a> <a href="#">m730:FlagAssenzaDati730-4</a> <a href="#">m730:FlagCfErratoDicTrasmessa</a> <a href="#">m730:Rettificativo</a> <a href="#">m730:Integrativo</a> <a href="#">m730:CfProduttoreSoftware</a> <a href="#">m730:SpazioDisposizioneUtente</a> <a href="#">m730:DichiarazioneCongiunta</a> <a href="#">m730:SituazioniParticolari</a> <a href="#">m730:Mod730SenzaSostituto</a> <a href="#">m730:ComunicazioneDatiRettificati</a> <a href="#">m730:SostCafProfessNonDelegato</a>
----------	---

element **Documento\_730\_Type/AltriDati/FlagConferma**

diagram					
namespace	urn:www.agenziaentrate.gov.it:specificheTecniche:sco:730				
type	<a href="#">DatoCB_Type</a>				
facets	<table border="1"> <tr> <th>Kind</th> <th>Value</th> </tr> <tr> <td>pattern</td> <td>[01]</td> </tr> </table>	Kind	Value	pattern	[01]
Kind	Value				
pattern	[01]				

element **Documento\_730\_Type/AltriDati/FlagAssenzaDati730-4**

diagram					
namespace	urn:www.agenziaentrate.gov.it:specificheTecniche:sco:730				
type	<a href="#">DatoCB_Type</a>				
facets	<table border="1"> <tr> <th>Kind</th> <th>Value</th> </tr> <tr> <td>pattern</td> <td>[01]</td> </tr> </table>	Kind	Value	pattern	[01]
Kind	Value				
pattern	[01]				

element **Documento\_730\_Type/AltriDati/FlagCfErratoDicTrasmessa**

diagram					
namespace	urn:www.agenziaentrate.gov.it:specificheTecniche:sco:730				
type	<a href="#">DatoCF_Type</a>				
facets	<table border="1"> <tr> <th>Kind</th> <th>Value</th> </tr> <tr> <td>pattern</td> <td>[0-9]{11}[[A-Z]{6}[0-9LMNPQRSTUUV]{2}[[A-Z]{1}[0-9LMNPQRSTUUV]{2}[[A-Z]{1}[0-9LMNPQRSTUUV]{3}[[A-Z]{1}</td> </tr> </table>	Kind	Value	pattern	[0-9]{11}[[A-Z]{6}[0-9LMNPQRSTUUV]{2}[[A-Z]{1}[0-9LMNPQRSTUUV]{2}[[A-Z]{1}[0-9LMNPQRSTUUV]{3}[[A-Z]{1}
Kind	Value				
pattern	[0-9]{11}[[A-Z]{6}[0-9LMNPQRSTUUV]{2}[[A-Z]{1}[0-9LMNPQRSTUUV]{2}[[A-Z]{1}[0-9LMNPQRSTUUV]{3}[[A-Z]{1}				

element **Documento\_730\_Type/AltriDati/Rettificativo**

diagram											
namespace	urn:www.agenziaentrate.gov.it:specificheTecniche:sco:730										
type	<a href="#">m730:Rettificativo_Type</a>										
facets	<table border="1"> <tr> <th>Kind</th> <th>Value</th> </tr> <tr> <td>pattern</td> <td>[1-9]</td> </tr> <tr> <td>enumeration</td> <td>1</td> </tr> <tr> <td>enumeration</td> <td>2</td> </tr> <tr> <td>enumeration</td> <td>3</td> </tr> </table>	Kind	Value	pattern	[1-9]	enumeration	1	enumeration	2	enumeration	3
Kind	Value										
pattern	[1-9]										
enumeration	1										
enumeration	2										
enumeration	3										

element **Documento\_730\_Type/AltriDati/Integrativo**

diagram	 m730:Integrativo										
namespace	urn:www.agenziaentrate.gov.it:specificheTecniche:sco:730										
type	<a href="#">m730:Integrativo_Type</a>										
facets	<table border="1"> <thead> <tr> <th>Kind</th> <th>Value</th> </tr> </thead> <tbody> <tr> <td>pattern</td> <td>[1-9]</td> </tr> <tr> <td>enumeration</td> <td>1</td> </tr> <tr> <td>enumeration</td> <td>2</td> </tr> <tr> <td>enumeration</td> <td>3</td> </tr> </tbody> </table>	Kind	Value	pattern	[1-9]	enumeration	1	enumeration	2	enumeration	3
Kind	Value										
pattern	[1-9]										
enumeration	1										
enumeration	2										
enumeration	3										

element **Documento\_730\_Type/AltriDati/CfProduttoreSoftware**

diagram	 m730:CfProduttore Software				
namespace	urn:www.agenziaentrate.gov.it:specificheTecniche:sco:730				
type	<a href="#">DatoCF_Type</a>				
facets	<table border="1"> <thead> <tr> <th>Kind</th> <th>Value</th> </tr> </thead> <tbody> <tr> <td>pattern</td> <td>[0-9]{11}[A-Z]{6}[0-9LMNPQRSTU]{2}[A-Z]{1}[0-9LMNPQRSTU]{2}[A-Z]{1}[0-9LMNPQRSTU]{3}[A-Z]{1}</td> </tr> </tbody> </table>	Kind	Value	pattern	[0-9]{11}[A-Z]{6}[0-9LMNPQRSTU]{2}[A-Z]{1}[0-9LMNPQRSTU]{2}[A-Z]{1}[0-9LMNPQRSTU]{3}[A-Z]{1}
Kind	Value				
pattern	[0-9]{11}[A-Z]{6}[0-9LMNPQRSTU]{2}[A-Z]{1}[0-9LMNPQRSTU]{2}[A-Z]{1}[0-9LMNPQRSTU]{3}[A-Z]{1}				

element **Documento\_730\_Type/AltriDati/SpazioDisposizioneUtente**

diagram	 m730:SpazioDisposizioneUtente				
namespace	urn:www.agenziaentrate.gov.it:specificheTecniche:sco:730				
type	<a href="#">DatoAN_Type</a>				
facets	<table border="1"> <thead> <tr> <th>Kind</th> <th>Value</th> </tr> </thead> <tbody> <tr> <td>pattern</td> <td>([0-9A-Z- &amp;quot;]{1})([ 0-9A-Z&amp;amp;:] ' \" . / ° \"\\(\\) À É È Ì Ò Ù Û &amp;quot; \\\" \\+)*</td> </tr> </tbody> </table>	Kind	Value	pattern	([0-9A-Z- &quot;]{1})([ 0-9A-Z&amp;:] ' \" . / ° \"\\(\\) À É È Ì Ò Ù Û &quot; \\\" \\+)*
Kind	Value				
pattern	([0-9A-Z- &quot;]{1})([ 0-9A-Z&amp;:] ' \" . / ° \"\\(\\) À É È Ì Ò Ù Û &quot; \\\" \\+)*				

element **Documento\_730\_Type/AltriDati/DichiarazioneCongiunta**

diagram	 m730:DichiarazioneCongiunta				
namespace	urn:www.agenziaentrate.gov.it:specificheTecniche:sco:730				
type	<a href="#">DatoCB_Type</a>				
facets	<table border="1"> <thead> <tr> <th>Kind</th> <th>Value</th> </tr> </thead> <tbody> <tr> <td>pattern</td> <td>[01]</td> </tr> </tbody> </table>	Kind	Value	pattern	[01]
Kind	Value				
pattern	[01]				

element **Documento\_730\_Type/AltriDati/SituazioniParticolari**

diagram	 m730:SituazioniParticolari
namespace	urn:www.agenziaentrate.gov.it:specificheTecniche:sco:730
type	<a href="#">DatoNP_Type</a>

facets	Kind	Value
	pattern	[1-9]{1}[0-9]*

element **Documento\_730\_Type/AltriDati/Mod730SenzaSostituto**

diagram		
namespace	urn:www.agenziaentrate.gov.it:specificheTecniche:sco:730	
type	restriction of <a href="#">DatoAN_Type</a>	
facets	Kind	Value
	pattern	(([0-9A-Z\-\_]\&quot;){1}([ 0-9A-Z&amp;]) \-\.\., /° °\°\(\ \) À È É Ì Ò Ù Ü \&quot; \ \ \ +)*
	enumeration	A

element **Documento\_730\_Type/AltriDati/ComunicazioneDatiRettificati**

diagram		
namespace	urn:www.agenziaentrate.gov.it:specificheTecniche:sco:730	
type	<a href="#">DatoCB_Type</a>	
facets	Kind	Value
	pattern	[01]

element **Documento\_730\_Type/AltriDati/SostCafProfessNonDelegato**

diagram		
namespace	urn:www.agenziaentrate.gov.it:specificheTecniche:sco:730	
type	<a href="#">DatoCB_Type</a>	
facets	Kind	Value
	pattern	[01]

element **Documento\_730\_Type/Sostituto**

diagram	
namespace	urn:www.agenziaentrate.gov.it:specificheTecniche:sco:730
type	<a href="#">m730:Sostituto_Type</a>
children	<a href="#">m730:CodiceFiscale</a> <a href="#">m730:DatiAnagraficiPF</a> <a href="#">m730:DenominazionePNF</a> <a href="#">m730:Residenza</a> <a href="#">m730:Fax</a> <a href="#">m730:CodiceSede</a>

element **Documento\_730\_Type/Mod730DipendentiSenzaSostituto**

diagram					
namespace	urn:www.agenziaentrate.gov.it:specificheTecniche:sco:730				
type	<a href="#">DatoCB_Type</a>				
facets	<table border="1"> <thead> <tr> <th>Kind</th> <th>Value</th> </tr> </thead> <tbody> <tr> <td>pattern</td> <td>[01]</td> </tr> </tbody> </table>	Kind	Value	pattern	[01]
Kind	Value				
pattern	[01]				



element **Documento\_730\_Type/SoggettoAssFiscaleDoc**

diagram	
namespace	urn:www.agenziaentrate.gov.it:specificheTecniche:sco:730
type	<a href="#">m730:Soggetto_Assistenza_Fiscale_Doc_Type</a>
children	<a href="#">m730:DataConsegna</a> <a href="#">m730:TipologiaSoggettoAssFisc</a> <a href="#">m730:SostitutoCF</a> <a href="#">m730:DatiCafDoc</a> <a href="#">m730:DatiProfessionistaDoc</a> <a href="#">m730:DatiAssociazioneDoc</a> <a href="#">m730:AgenziaEntrate</a>

element **Documento\_730\_Type/Documento\_730-4**

diagram	
namespace	urn:www.agenziaentrate.gov.it:specificheTecniche:sco:730
type	<a href="#">m730:Documento_730-4</a>
children	<a href="#">m730:DatiAnagraficiDichiarante</a> <a href="#">m730:Sostituto</a> <a href="#">m730:SoggettoAssFiscale730-4</a> <a href="#">m730:AltriDati</a> <a href="#">m730:DatiContabili730-4</a>

element **Documento\_730\_Type/EsitiContabili**

diagram	<p>The diagram shows a container element <b>m730:EsitiContabili</b> (dashed box) connected to a central connector. This connector is linked to three child elements: <b>m730:Conguaglio</b>, <b>m730:Mod730Integrativo</b>, and <b>m730:VersamentiF24</b>, all shown in dashed boxes with a plus sign icon.</p>
namespace	urn:www.agenziaentrate.gov.it:specificheTecniche:sco:730
children	<a href="#">m730:Conguaglio</a> <a href="#">m730:Mod730Integrativo</a> <a href="#">m730:VersamentiF24</a>

element **Documento\_730\_Type/EsitiContabili/Conguaglio**

diagram	<p>The diagram shows a container element <b>m730:Conguaglio</b> (dashed box) connected to a central connector. This connector is linked to a large yellow-shaded container labeled <b>m730:Conguaglio_Type</b>. Inside this container, several fields are listed in dashed boxes: <b>m730:NumeroRate</b>, <b>m730:ImportoTrattenutoSaldo</b>, <b>m730:ImportoTrattenutoAcconto</b>, <b>m730:ImportoDaVersareF24Saldo</b>, <b>m730:ImportoDaVersareF24Acc...</b>, <b>m730:ImportoRimborsato</b>, <b>m730:ImportoRimborsatoAgenzia</b>, and <b>m730:OpzioneInformativa</b>.</p>
namespace	urn:www.agenziaentrate.gov.it:specificheTecniche:sco:730
type	<a href="#">m730:Conguaglio_Type</a>
children	<a href="#">m730:NumeroRate</a> <a href="#">m730:ImportoTrattenutoSaldo</a> <a href="#">m730:ImportoTrattenutoAcconto</a> <a href="#">m730:ImportoDaVersareF24Saldo</a> <a href="#">m730:ImportoDaVersareF24Acconto</a> <a href="#">m730:ImportoRimborsato</a> <a href="#">m730:ImportoRimborsatoAgenzia</a> <a href="#">m730:OpzioneInformativa</a>

element **Documento\_730\_Type/EsitiContabili/Mod730Integrativo**

<p>diagram</p>	
<p>namespace</p>	<p>urn:www.agenziaentrato.gov.it:specificheTecniche:sco:730</p>
<p>type</p>	<p><a href="#">m730:Mod730_Integrativo_Type</a></p>
<p>children</p>	<p><a href="#">m730:ImportiRimborsare</a> <a href="#">m730:ImportoRimborsato</a> <a href="#">m730:ImportoRimborsatoAgenzia</a></p>

element **Documento\_730\_Type/EsitiContabili/VersamentiF24**

<p>diagram</p>	
<p>namespace</p>	<p>urn:www.agenziaentrate.gov.it:specificheTecniche:sco:730</p>
<p>type</p>	<p><a href="#">m730:Versamenti_F24_Type</a></p>
<p>children</p>	<p><a href="#">m730:F24DebitoIrpef</a> <a href="#">m730:F24DebitoCodRegione</a> <a href="#">m730:F24DebitoAddReg</a> <a href="#">m730:F24DebitoCodComune</a> <a href="#">m730:F24DebitoAddCom</a> <a href="#">m730:F24DebitoPrimaRataAcclrpef</a> <a href="#">m730:F24DebitoAccontoTassSep</a> <a href="#">m730:F24DebitoCodComuneAcconto</a> <a href="#">m730:F24DebitoAccontoAddCom</a> <a href="#">m730:F24DebitoImpostaSost</a> <a href="#">m730:F24DebitoCedolare</a> <a href="#">m730:F24DebitoPrimaRataAccCedolare</a> <a href="#">m730:F24DebitoCodRegioneConiuge</a></p>

	<a href="#">m730:F24DebitoAddRegConiuge</a> <a href="#">m730:F24DebitoCodComuneConiuge</a> <a href="#">m730:F24DebitoAddComConiuge</a> <a href="#">m730:F24DebitoCodComuneAccontoConiuge</a> <a href="#">m730:F24DebitoAccontoAddComConiuge</a> <a href="#">m730:F24DebitoSecondaRataAcclrpef</a> <a href="#">m730:F24DebitoSecondaRataAccCedolare</a>
--	--

element **Documento\_730\_Type/DatiRettificati**

diagram	
namespace	urn:www.agenziaentrate.gov.it:specificheTecniche:sco:730
type	<a href="#">m730:Dati_Rettificati_Type</a>
children	<a href="#">m730:Modulo</a>

complexType **Domanda\_Accatamento\_Type**

diagram	
namespace	urn:www.agenziaentrate.gov.it:specificheTecniche:sco:730
children	<a href="#">m730:Data</a> <a href="#">m730:Numero</a> <a href="#">m730:ProvinciaUfficio</a>

element **Domanda\_Accatamento\_Type/Data**

diagram					
namespace	urn:www.agenziaentrate.gov.it:specificheTecniche:sco:730				
type	<a href="#">DatoDT_Type</a>				
facets	<table border="1"> <thead> <tr> <th>Kind</th> <th>Value</th> </tr> </thead> <tbody> <tr> <td>pattern</td> <td>(((0[1-9][12][0-9]3[01])(0[13578]10 12)(\d{4})) ((0[1-9][12][0-9]30)(0[469]11)(\d{4})) ((0[1-9]1[0-9]2[0-8])(02)(\d{4})) ((29)(02)([02468][048]00)) ((29)(02)([13579][26]00)) ((29)(02)([0-9][0-9][0]48)) ((29)(02)([0-9][0-9][2468][048])) ((29)(02)([0-9][0-9][13579][26]))))</td> </tr> </tbody> </table>	Kind	Value	pattern	(((0[1-9][12][0-9]3[01])(0[13578]10 12)(\d{4})) ((0[1-9][12][0-9]30)(0[469]11)(\d{4})) ((0[1-9]1[0-9]2[0-8])(02)(\d{4})) ((29)(02)([02468][048]00)) ((29)(02)([13579][26]00)) ((29)(02)([0-9][0-9][0]48)) ((29)(02)([0-9][0-9][2468][048])) ((29)(02)([0-9][0-9][13579][26]))))
Kind	Value				
pattern	(((0[1-9][12][0-9]3[01])(0[13578]10 12)(\d{4})) ((0[1-9][12][0-9]30)(0[469]11)(\d{4})) ((0[1-9]1[0-9]2[0-8])(02)(\d{4})) ((29)(02)([02468][048]00)) ((29)(02)([13579][26]00)) ((29)(02)([0-9][0-9][0]48)) ((29)(02)([0-9][0-9][2468][048])) ((29)(02)([0-9][0-9][13579][26]))))				

element **Domanda\_Accatamento\_Type/Numero**

diagram	
namespace	urn:www.agenziaentrate.gov.it:specificheTecniche:sco:730
type	<a href="#">DatoAN_Type</a>

facets	Kind	Value
	pattern	([0-9A-Z-] \&quot;){1}([ 0-9A-Z&amp;#39; ! ~ \., / ^*\(\)\ À É È Ì Ò Ù Ú &quot; \ \\ / +)*

**element Domanda\_Accatastamento\_Type/ProvinciaUfficio**

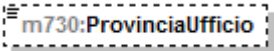
diagram	
namespace	urn:www.agenziaentrate.gov.it:specificheTecniche:sco:730
type	<a href="#">PN_Type</a>

**complexType Domicilio\_Fiscale\_Type**

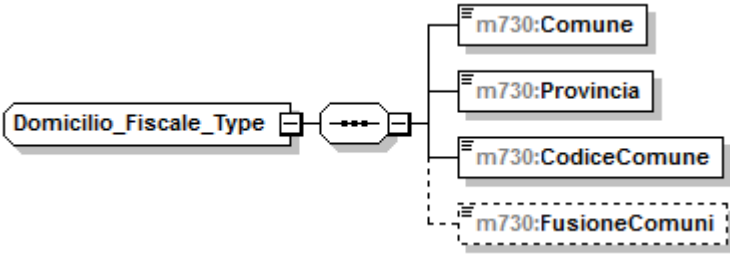
diagram	
namespace	urn:www.agenziaentrate.gov.it:specificheTecniche:sco:730
children	<a href="#">m730:Comune</a> <a href="#">m730:Provincia</a> <a href="#">m730:CodiceComune</a> <a href="#">m730:FusioneComuni</a>

**element Domicilio\_Fiscale\_Type/Comune**

diagram		
namespace	urn:www.agenziaentrate.gov.it:specificheTecniche:sco:730	
type	<a href="#">DatoAN_Type</a>	
facets	Kind	Value
	pattern	([0-9A-Z-] \&quot;){1}([ 0-9A-Z&amp;#39; ! ~ \., / ^*\(\)\ À É È Ì Ò Ù Ú &quot; \ \\ / +)*

**element Domicilio\_Fiscale\_Type/Provincia**

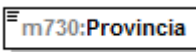
diagram	
namespace	urn:www.agenziaentrate.gov.it:specificheTecniche:sco:730
type	<a href="#">PR_Type</a>

**element Domicilio\_Fiscale\_Type/CodiceComune**

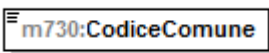
diagram	
---------	---

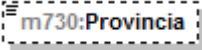

element **Domicilio\_Sogg\_Ass\_Fiscale\_Type/Provincia**

diagram	
namespace	urn:www.agenziaentrate.gov.it:specificheTecniche:sco:730
type	<a href="#">PR_Type</a>

element **Domicilio\_Sogg\_Ass\_Fiscale\_Type/CodiceComune**

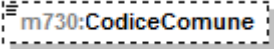
diagram					
namespace	urn:www.agenziaentrate.gov.it:specificheTecniche:sco:730				
type	<a href="#">DatoAN_Type</a>				
facets	<table border="0"> <tr> <td>Kind</td> <td>Value</td> </tr> <tr> <td>pattern</td> <td>(([0-9A-Z\-\_]&amp;quot;){1}([ 0-9A-Z&amp;amp;:] [\-\.\, /°\^\(\)\ À É È Ì Ò Ù Û]&amp;quot; \ \ \ +)*</td> </tr> </table>	Kind	Value	pattern	(([0-9A-Z\-\_]&quot;){1}([ 0-9A-Z&amp;:] [\-\.\, /°\^\(\)\ À É È Ì Ò Ù Û]&quot; \ \ \ +)*
Kind	Value				
pattern	(([0-9A-Z\-\_]&quot;){1}([ 0-9A-Z&amp;:] [\-\.\, /°\^\(\)\ À É È Ì Ò Ù Û]&quot; \ \ \ +)*				

element **Domicilio\_Sogg\_Ass\_Fiscale\_Type/Cap**

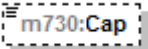
diagram					
namespace	urn:www.agenziaentrate.gov.it:specificheTecniche:sco:730				
type	<a href="#">DatoAN_Type</a>				
facets	<table border="0"> <tr> <td>Kind</td> <td>Value</td> </tr> <tr> <td>pattern</td> <td>(([0-9A-Z\-\_]&amp;quot;){1}([ 0-9A-Z&amp;amp;:] [\-\.\, /°\^\(\)\ À É È Ì Ò Ù Û]&amp;quot; \ \ \ +)*</td> </tr> </table>	Kind	Value	pattern	(([0-9A-Z\-\_]&quot;){1}([ 0-9A-Z&amp;:] [\-\.\, /°\^\(\)\ À É È Ì Ò Ù Û]&quot; \ \ \ +)*
Kind	Value				
pattern	(([0-9A-Z\-\_]&quot;){1}([ 0-9A-Z&amp;:] [\-\.\, /°\^\(\)\ À É È Ì Ò Ù Û]&quot; \ \ \ +)*				

element **Domicilio\_Sogg\_Ass\_Fiscale\_Type/Indirizzo**

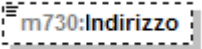
diagram					
namespace	urn:www.agenziaentrate.gov.it:specificheTecniche:sco:730				
type	<a href="#">DatoAN_Type</a>				
facets	<table border="0"> <tr> <td>Kind</td> <td>Value</td> </tr> <tr> <td>pattern</td> <td>(([0-9A-Z\-\_]&amp;quot;){1}([ 0-9A-Z&amp;amp;:] [\-\.\, /°\^\(\)\ À É È Ì Ò Ù Û]&amp;quot; \ \ \ +)*</td> </tr> </table>	Kind	Value	pattern	(([0-9A-Z\-\_]&quot;){1}([ 0-9A-Z&amp;:] [\-\.\, /°\^\(\)\ À É È Ì Ò Ù Û]&quot; \ \ \ +)*
Kind	Value				
pattern	(([0-9A-Z\-\_]&quot;){1}([ 0-9A-Z&amp;:] [\-\.\, /°\^\(\)\ À É È Ì Ò Ù Û]&quot; \ \ \ +)*				

element **Domicilio\_Sogg\_Ass\_Fiscale\_Type/Telefono**

diagram					
namespace	urn:www.agenziaentrate.gov.it:specificheTecniche:sco:730				
type	<a href="#">DatoAN_Type</a>				
facets	<table border="0"> <tr> <td>Kind</td> <td>Value</td> </tr> <tr> <td>pattern</td> <td>(([0-9A-Z\-\_]&amp;quot;){1}([ 0-9A-Z&amp;amp;:] [\-\.\, /°\^\(\)\ À É È Ì Ò Ù Û]&amp;quot; \ \ \ +)*</td> </tr> </table>	Kind	Value	pattern	(([0-9A-Z\-\_]&quot;){1}([ 0-9A-Z&amp;:] [\-\.\, /°\^\(\)\ À É È Ì Ò Ù Û]&quot; \ \ \ +)*
Kind	Value				
pattern	(([0-9A-Z\-\_]&quot;){1}([ 0-9A-Z&amp;:] [\-\.\, /°\^\(\)\ À É È Ì Ò Ù Û]&quot; \ \ \ +)*				



element **Domicilio\_Sogg\_Ass\_Fiscale\_Type/FAX**

diagram	
namespace	urn:www.agenziaentrate.gov.it:specificheTecniche:sco:730
type	<a href="#">DatoAN_Type</a>
facets	Kind Value pattern (([0-9A-Z-] \&quot;){1}([ 0-9A-Z&amp;:] ' - \., /° ^\(\ \) À É È Ì Ò Ù Û &quot; \ \\ / +)*

element **Domicilio\_Sogg\_Ass\_Fiscale\_Type/Email**

diagram	
namespace	urn:www.agenziaentrate.gov.it:specificheTecniche:sco:730
type	<a href="#">DatoEM_Type</a>
facets	Kind Value pattern [a-zA-Z0-9._%!\-'\&quot;?^~=]+@[a-zA-Z0-9.\-]+\.[a-zA-Z]{2,4}

complexType **Eccedenze\_Oltre\_Anno\_Type**

diagram	
namespace	urn:www.agenziaentrate.gov.it:specificheTecniche:sco:730
children	<a href="#">m730:Anno</a> <a href="#">m730:Irpef</a> <a href="#">m730:SostitutivaQuadroRT</a> <a href="#">m730:CedolareSecca</a> <a href="#">m730:CodiceRegione</a> <a href="#">m730:AddRegionaleIrpef</a> <a href="#">m730:CodiceCatastaleComune</a> <a href="#">m730:AddComunaleIrpef</a> <a href="#">m730:ImpostaSostitutiva</a>

element **Eccedenze\_Oltre\_Anno\_Type/Anno**

diagram	
---------	--



enumeration	8
enumeration	9
enumeration	10
enumeration	11
enumeration	12
enumeration	13
enumeration	14
enumeration	15
enumeration	16
enumeration	17
enumeration	18
enumeration	19
enumeration	20
enumeration	21

**element Ecdednze\_Oltre\_Anno\_Type/AddRegionalelrpef**

diagram	 m730:AddRegionalelrpef				
namespace	urn:www.agenziaentrate.gov.it:specificheTecniche:sco:730				
type	<a href="#">DatoNP_Type</a>				
facets	<table border="1"> <tr><td>Kind</td><td>Value</td></tr> <tr><td>pattern</td><td>[1-9]{1}[0-9]*</td></tr> </table>	Kind	Value	pattern	[1-9]{1}[0-9]*
Kind	Value				
pattern	[1-9]{1}[0-9]*				

**element Ecdednze\_Oltre\_Anno\_Type/CodiceCatastaleComune**

diagram	 m730:CodiceCatastaleComune				
namespace	urn:www.agenziaentrate.gov.it:specificheTecniche:sco:730				
type	restriction of <a href="#">DatoAN_Type</a>				
facets	<table border="1"> <tr><td>Kind</td><td>Value</td></tr> <tr><td>pattern</td><td>([0-9A-Z-] \&amp;quot;){1}([ 0-9A-Z&amp;amp;:] ' \- \., / ^ \^\(\\) À È É Ì Ò Ù Û &amp;quot; \\ /+)*</td></tr> </table>	Kind	Value	pattern	([0-9A-Z-] \&quot;){1}([ 0-9A-Z&amp;:] ' \- \., / ^ \^\(\\) À È É Ì Ò Ù Û &quot; \\ /+)*
Kind	Value				
pattern	([0-9A-Z-] \&quot;){1}([ 0-9A-Z&amp;:] ' \- \., / ^ \^\(\\) À È É Ì Ò Ù Û &quot; \\ /+)*				

**element Ecdednze\_Oltre\_Anno\_Type/AddComunalelrpef**

diagram	 m730:AddComunalelrpef				
namespace	urn:www.agenziaentrate.gov.it:specificheTecniche:sco:730				
type	<a href="#">DatoNP_Type</a>				
facets	<table border="1"> <tr><td>Kind</td><td>Value</td></tr> <tr><td>pattern</td><td>[1-9]{1}[0-9]*</td></tr> </table>	Kind	Value	pattern	[1-9]{1}[0-9]*
Kind	Value				
pattern	[1-9]{1}[0-9]*				

**element Ecdednze\_Oltre\_Anno\_Type/ImpostaSostitutiva**

diagram	 m730:ImpostaSostitutiva
namespace	urn:www.agenziaentrate.gov.it:specificheTecniche:sco:730
type	<a href="#">DatoNP_Type</a>

facets	Kind pattern	Value [1-9]{1}[0-9]*
--------	-----------------	-------------------------

### complexType **Eccedenze\_Type**

diagram	
namespace	urn:www.agenziaentrate.gov.it:specificheTecniche:sco:730
children	<a href="#">m730:lrp ef</a> <a href="#">m730:lrp efCompF24</a> <a href="#">m730:SostitutivaQuadroRT</a> <a href="#">m730:SostitutivaQuadroRTcompF24</a> <a href="#">m730:CedolareSecca</a> <a href="#">m730:CedolareSeccaCompF24</a> <a href="#">m730:CodiceRegione</a> <a href="#">m730:AddRegionalelrp ef</a> <a href="#">m730:AddRegionalelrp efCompF24</a> <a href="#">m730:CodiceCatastaleComune</a> <a href="#">m730:AddComunalelrp ef</a> <a href="#">m730:AddComunalelrp efF24</a> <a href="#">m730:PremioRisultato</a> <a href="#">m730:PremioRisultatoCompF24</a>

### element **Eccedenze\_Type/lrp ef**

diagram		
namespace	urn:www.agenziaentrate.gov.it:specificheTecniche:sco:730	
type	<a href="#">DatoNP_Type</a>	
facets	Kind pattern	Value [1-9]{1}[0-9]*

element **Eccedenze\_Type/lrpefCompF24**

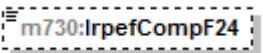
diagram					
namespace	urn:www.agenziaentrate.gov.it:specificheTecniche:sco:730				
type	<a href="#">DatoNP_Type</a>				
facets	<table border="1"> <tr> <td>Kind</td> <td>Value</td> </tr> <tr> <td>pattern</td> <td>[1-9]{1}[0-9]*</td> </tr> </table>	Kind	Value	pattern	[1-9]{1}[0-9]*
Kind	Value				
pattern	[1-9]{1}[0-9]*				

element **Eccedenze\_Type/SostitutivaQuadroRT**

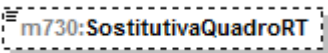
diagram					
namespace	urn:www.agenziaentrate.gov.it:specificheTecniche:sco:730				
type	<a href="#">DatoNP_Type</a>				
facets	<table border="1"> <tr> <td>Kind</td> <td>Value</td> </tr> <tr> <td>pattern</td> <td>[1-9]{1}[0-9]*</td> </tr> </table>	Kind	Value	pattern	[1-9]{1}[0-9]*
Kind	Value				
pattern	[1-9]{1}[0-9]*				

element **Eccedenze\_Type/SostitutivaQuadroRTcompF24**

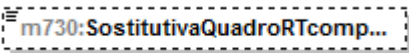
diagram					
namespace	urn:www.agenziaentrate.gov.it:specificheTecniche:sco:730				
type	<a href="#">DatoNP_Type</a>				
facets	<table border="1"> <tr> <td>Kind</td> <td>Value</td> </tr> <tr> <td>pattern</td> <td>[1-9]{1}[0-9]*</td> </tr> </table>	Kind	Value	pattern	[1-9]{1}[0-9]*
Kind	Value				
pattern	[1-9]{1}[0-9]*				

element **Eccedenze\_Type/CedolareSecca**

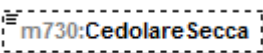
diagram					
namespace	urn:www.agenziaentrate.gov.it:specificheTecniche:sco:730				
type	<a href="#">DatoNP_Type</a>				
facets	<table border="1"> <tr> <td>Kind</td> <td>Value</td> </tr> <tr> <td>pattern</td> <td>[1-9]{1}[0-9]*</td> </tr> </table>	Kind	Value	pattern	[1-9]{1}[0-9]*
Kind	Value				
pattern	[1-9]{1}[0-9]*				

element **Eccedenze\_Type/CedolareSeccaCompF24**

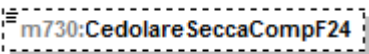
diagram					
namespace	urn:www.agenziaentrate.gov.it:specificheTecniche:sco:730				
type	<a href="#">DatoNP_Type</a>				
facets	<table border="1"> <tr> <td>Kind</td> <td>Value</td> </tr> <tr> <td>pattern</td> <td>[1-9]{1}[0-9]*</td> </tr> </table>	Kind	Value	pattern	[1-9]{1}[0-9]*
Kind	Value				
pattern	[1-9]{1}[0-9]*				

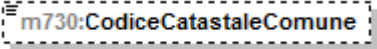

element **Eccedenze\_Type/CodiceCatastaleComune**

diagram	
namespace	urn:www.agenziaentrate.gov.it:specificheTecniche:sco:730
type	restriction of <a href="#">DatoAN_Type</a>
facets	Kind Value pattern (([0-9A-Z\-\] \&quot;){1}([ 0-9A-Z&amp;:] \-\ \., / \^\ \(\ \)\ À É È Ì Ò Ù Ü &quot; \ \\ \ /+)*

element **Eccedenze\_Type/AddComunalelrpef**

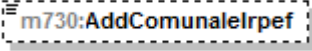
diagram	
namespace	urn:www.agenziaentrate.gov.it:specificheTecniche:sco:730
type	<a href="#">DatoNP_Type</a>
facets	Kind Value pattern [1-9]{1}[0-9]*

element **Eccedenze\_Type/AddComunalelrpefF24**

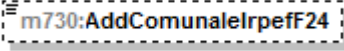
diagram	
namespace	urn:www.agenziaentrate.gov.it:specificheTecniche:sco:730
type	<a href="#">DatoNP_Type</a>
facets	Kind Value pattern [1-9]{1}[0-9]*

element **Eccedenze\_Type/PremioRisultato**

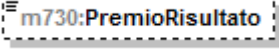
diagram	
namespace	urn:www.agenziaentrate.gov.it:specificheTecniche:sco:730
type	<a href="#">DatoNP_Type</a>
facets	Kind Value pattern [1-9]{1}[0-9]*

element **Eccedenze\_Type/PremioRisultatoCompF24**

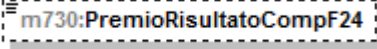
diagram	
namespace	urn:www.agenziaentrate.gov.it:specificheTecniche:sco:730
type	<a href="#">DatoNP_Type</a>
facets	Kind Value pattern [1-9]{1}[0-9]*

complexType **Elemento\_Integrativo\_Type**

diagram	
namespace	urn:www.agenziaentrate.gov.it:specificheTecniche:sco:730
children	<a href="#">m730:lrpef</a> <a href="#">m730:AddizionaleRegionalelrpef</a> <a href="#">m730:AddComunalelrpef</a> <a href="#">m730:CedolareSecca</a>

element **Elemento\_Integrativo\_Type/lrpef**

diagram					
namespace	urn:www.agenziaentrate.gov.it:specificheTecniche:sco:730				
type	<a href="#">DatoNP_Type</a>				
facets	<table border="1"> <thead> <tr> <th>Kind</th> <th>Value</th> </tr> </thead> <tbody> <tr> <td>pattern</td> <td>[1-9]{1}[0-9]*</td> </tr> </tbody> </table>	Kind	Value	pattern	[1-9]{1}[0-9]*
Kind	Value				
pattern	[1-9]{1}[0-9]*				

element **Elemento\_Integrativo\_Type/AddizionaleRegionalelrpef**

diagram					
namespace	urn:www.agenziaentrate.gov.it:specificheTecniche:sco:730				
type	<a href="#">DatoNP_Type</a>				
facets	<table border="1"> <thead> <tr> <th>Kind</th> <th>Value</th> </tr> </thead> <tbody> <tr> <td>pattern</td> <td>[1-9]{1}[0-9]*</td> </tr> </tbody> </table>	Kind	Value	pattern	[1-9]{1}[0-9]*
Kind	Value				
pattern	[1-9]{1}[0-9]*				

element **Elemento\_Integrativo\_Type/AddComunalelrpef**

diagram					
namespace	urn:www.agenziaentrate.gov.it:specificheTecniche:sco:730				
type	<a href="#">DatoNP_Type</a>				
facets	<table border="1"> <thead> <tr> <th>Kind</th> <th>Value</th> </tr> </thead> <tbody> <tr> <td>pattern</td> <td>[1-9]{1}[0-9]*</td> </tr> </tbody> </table>	Kind	Value	pattern	[1-9]{1}[0-9]*
Kind	Value				
pattern	[1-9]{1}[0-9]*				

element **Elemento\_Integrativo\_Type/CedolareSecca**

diagram	
---------	--



namespace	urn:www.agenziaentrate.gov.it:specificheTecniche:sco:730
type	<a href="#">DatoNP_Type</a>
facets	Kind Value pattern [1-9]{1}[0-9]*

### complexType **Esenzione\_Add\_Comunale\_Type**

diagram	
namespace	urn:www.agenziaentrate.gov.it:specificheTecniche:sco:730
children	<a href="#">m730:SogliaEsenzioneSaldo</a> <a href="#">m730:SogliaEsenzioneAcconto</a>

### element **Esenzione\_Add\_Comunale\_Type/SogliaEsenzioneSaldo**

diagram	
namespace	urn:www.agenziaentrate.gov.it:specificheTecniche:sco:730
type	<a href="#">m730:Soglie_Esenzione_Type</a>
children	<a href="#">m730:SogliaEsenzione</a> <a href="#">m730:EsenzioneTotale</a>

### element **Esenzione\_Add\_Comunale\_Type/SogliaEsenzioneAcconto**

diagram	
namespace	urn:www.agenziaentrate.gov.it:specificheTecniche:sco:730
type	<a href="#">m730:Soglie_Esenzione_Type</a>
children	<a href="#">m730:SogliaEsenzione</a> <a href="#">m730:EsenzioneTotale</a>

complexType **Esenzione\_Bonus\_Type**

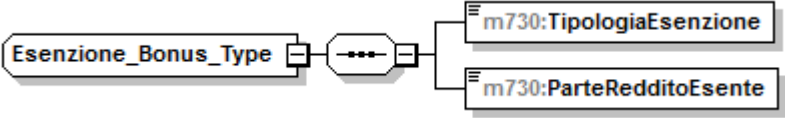
diagram	
namespace	urn:www.agenziaentrate.gov.it:specificheTecniche:sco:730
children	<a href="#">m730:TipologiaEsenzione</a> <a href="#">m730:ParteRedditoEsente</a>

element **Esenzione\_Bonus\_Type/TipologiaEsenzione**

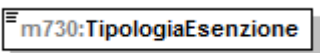
diagram									
namespace	urn:www.agenziaentrate.gov.it:specificheTecniche:sco:730								
type	restriction of <a href="#">DatoN1_Type</a>								
facets	<table border="1"> <thead> <tr> <th>Kind</th> <th>Value</th> </tr> </thead> <tbody> <tr> <td>pattern</td> <td>[1-9]</td> </tr> <tr> <td>enumeration</td> <td>1</td> </tr> <tr> <td>enumeration</td> <td>2</td> </tr> </tbody> </table>	Kind	Value	pattern	[1-9]	enumeration	1	enumeration	2
Kind	Value								
pattern	[1-9]								
enumeration	1								
enumeration	2								

element **Esenzione\_Bonus\_Type/ParteRedditoEsente**

diagram					
namespace	urn:www.agenziaentrate.gov.it:specificheTecniche:sco:730				
type	<a href="#">DatoNP_Type</a>				
facets	<table border="1"> <thead> <tr> <th>Kind</th> <th>Value</th> </tr> </thead> <tbody> <tr> <td>pattern</td> <td>[1-9]{1}[0-9]*</td> </tr> </tbody> </table>	Kind	Value	pattern	[1-9]{1}[0-9]*
Kind	Value				
pattern	[1-9]{1}[0-9]*				

complexType **Esito\_Liquidazione\_Type**

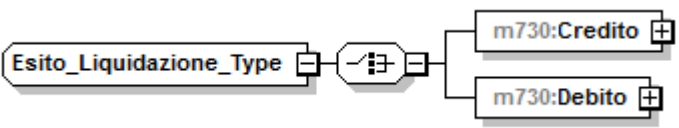
diagram	
namespace	urn:www.agenziaentrate.gov.it:specificheTecniche:sco:730
children	<a href="#">m730:Credito</a> <a href="#">m730:Debito</a>

element **Esito\_Liquidazione\_Type/Credito**

diagram	
namespace	urn:www.agenziaentrate.gov.it:specificheTecniche:sco:730
type	<a href="#">m730:Credito_Type</a>
children	<a href="#">m730:NonRimborsabile</a> <a href="#">m730:Credito</a> <a href="#">m730:CreditoF24</a> <a href="#">m730:CreditoRimborso</a>

element **Esito\_Liquidazione\_Type/Debito**

diagram	
namespace	urn:www.agenziaentrate.gov.it:specificheTecniche:sco:730
type	<a href="#">m730:Debito_Type</a>
children	<a href="#">m730:NonVersare</a> <a href="#">m730:ImportoDaTrattenere</a>

complexType **Fabbricato\_Agev\_Type**

diagram	
namespace	urn:www.agenziaentrate.gov.it:specificheTecniche:sco:730
children	<a href="#">m730:NumeroRigoRiferimento</a> <a href="#">m730:NumModuloRiferimento</a> <a href="#">m730:DatiContratto</a> <a href="#">m730:CasellaInf30Giorni</a> <a href="#">m730:AnnoDichiarazioneIcilmu</a>

element **Fabbricato\_Agev\_Type/NumeroRigoRiferimento**

diagram																									
namespace	urn:www.agenziaentrate.gov.it:specificheTecniche:sco:730																								
type	<a href="#">m730:Fabbricato_Agev_Numero_Rigo_Type</a>																								
facets	<table border="1"> <thead> <tr> <th>Kind</th> <th>Value</th> </tr> </thead> <tbody> <tr> <td>pattern</td> <td>[1-9]{1}[0-9]*</td> </tr> <tr> <td>enumeration</td> <td>1</td> </tr> <tr> <td>enumeration</td> <td>2</td> </tr> <tr> <td>enumeration</td> <td>3</td> </tr> <tr> <td>enumeration</td> <td>4</td> </tr> <tr> <td>enumeration</td> <td>5</td> </tr> <tr> <td>enumeration</td> <td>6</td> </tr> <tr> <td>enumeration</td> <td>7</td> </tr> <tr> <td>enumeration</td> <td>8</td> </tr> <tr> <td>enumeration</td> <td>9</td> </tr> <tr> <td>enumeration</td> <td>10</td> </tr> </tbody> </table>	Kind	Value	pattern	[1-9]{1}[0-9]*	enumeration	1	enumeration	2	enumeration	3	enumeration	4	enumeration	5	enumeration	6	enumeration	7	enumeration	8	enumeration	9	enumeration	10
Kind	Value																								
pattern	[1-9]{1}[0-9]*																								
enumeration	1																								
enumeration	2																								
enumeration	3																								
enumeration	4																								
enumeration	5																								
enumeration	6																								
enumeration	7																								
enumeration	8																								
enumeration	9																								
enumeration	10																								

element **Fabbricato\_Agev\_Type/NumModuloRiferimento**

diagram					
namespace	urn:www.agenziaentrate.gov.it:specificheTecniche:sco:730				
type	<a href="#">DatoNP_Type</a>				
facets	<table border="1"> <thead> <tr> <th>Kind</th> <th>Value</th> </tr> </thead> <tbody> <tr> <td>pattern</td> <td>[1-9]{1}[0-9]*</td> </tr> </tbody> </table>	Kind	Value	pattern	[1-9]{1}[0-9]*
Kind	Value				
pattern	[1-9]{1}[0-9]*				

element **Fabbricato\_Agev\_Type/DatiContratto**

diagram	
namespace	urn:www.agenziaentrate.gov.it:specificheTecniche:sco:730
type	<a href="#">m730:Dati_Contratto_Type</a>
children	<a href="#">m730:DataRegContratto</a> <a href="#">m730:SerieContratto</a> <a href="#">m730:NumeroContratto</a> <a href="#">m730:Sottonumero</a> <a href="#">m730:CodiceUfficio</a> <a href="#">m730:IdentificativoContratto</a>

element **Fabbricato\_Agev\_Type/CasellaInf30Giorni**

diagram	
namespace	urn:www.agenziaentrate.gov.it:specificheTecniche:sco:730
type	<a href="#">DatoCB_Type</a>
facets	Kind Value pattern [01]

element **Fabbricato\_Agev\_Type/AnnoDichiarazioneIcilmu**

diagram	
namespace	urn:www.agenziaentrate.gov.it:specificheTecniche:sco:730
type	<a href="#">DatoDA_Type</a>
facets	Kind Value pattern (18 19 20)[0-9]{2}

complexType **Fabbricato\_Ord\_Type**

diagram	
namespace	urn:www.agenziaentrate.gov.it:specificheTecniche:sco:730

children	<a href="#">m730:Rendita</a> <a href="#">m730:Utilizzo</a> <a href="#">m730:GiorniPossesso</a> <a href="#">m730:PercPossesso</a> <a href="#">m730:CodiceCanone</a> <a href="#">m730:CanoneLocazione</a> <a href="#">m730:CasiParticolari</a> <a href="#">m730:CasellaContinuazione</a> <a href="#">m730:CodiceComune</a> <a href="#">m730:OpzioneCedolare</a> <a href="#">m730:CasellaCasiPartlmu</a> <a href="#">m730:StatoEmergenza</a>
----------	---

#### element **Fabbricato\_Ord\_Type/Rendita**

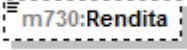
diagram					
namespace	urn:www.agenziaentrate.gov.it:specificheTecniche:sco:730				
type	<a href="#">DatoNP_Type</a>				
facets	<table border="1"> <thead> <tr> <th>Kind</th> <th>Value</th> </tr> </thead> <tbody> <tr> <td>pattern</td> <td>[1-9]{1}[0-9]*</td> </tr> </tbody> </table>	Kind	Value	pattern	[1-9]{1}[0-9]*
Kind	Value				
pattern	[1-9]{1}[0-9]*				

#### element **Fabbricato\_Ord\_Type/Utilizzo**

diagram																																	
namespace	urn:www.agenziaentrate.gov.it:specificheTecniche:sco:730																																
type	restriction of <a href="#">m730:Utilizzo_Fabbricato_Type</a>																																
facets	<table border="1"> <thead> <tr> <th>Kind</th> <th>Value</th> </tr> </thead> <tbody> <tr> <td>pattern</td> <td>[1-9]{1}[0-9]*</td> </tr> <tr> <td>enumeration</td> <td>1</td> </tr> <tr> <td>enumeration</td> <td>2</td> </tr> <tr> <td>enumeration</td> <td>3</td> </tr> <tr> <td>enumeration</td> <td>4</td> </tr> <tr> <td>enumeration</td> <td>5</td> </tr> <tr> <td>enumeration</td> <td>8</td> </tr> <tr> <td>enumeration</td> <td>9</td> </tr> <tr> <td>enumeration</td> <td>10</td> </tr> <tr> <td>enumeration</td> <td>11</td> </tr> <tr> <td>enumeration</td> <td>12</td> </tr> <tr> <td>enumeration</td> <td>14</td> </tr> <tr> <td>enumeration</td> <td>15</td> </tr> <tr> <td>enumeration</td> <td>16</td> </tr> <tr> <td>enumeration</td> <td>17</td> </tr> </tbody> </table>	Kind	Value	pattern	[1-9]{1}[0-9]*	enumeration	1	enumeration	2	enumeration	3	enumeration	4	enumeration	5	enumeration	8	enumeration	9	enumeration	10	enumeration	11	enumeration	12	enumeration	14	enumeration	15	enumeration	16	enumeration	17
Kind	Value																																
pattern	[1-9]{1}[0-9]*																																
enumeration	1																																
enumeration	2																																
enumeration	3																																
enumeration	4																																
enumeration	5																																
enumeration	8																																
enumeration	9																																
enumeration	10																																
enumeration	11																																
enumeration	12																																
enumeration	14																																
enumeration	15																																
enumeration	16																																
enumeration	17																																

#### element **Fabbricato\_Ord\_Type/GiorniPossesso**

diagram					
namespace	urn:www.agenziaentrate.gov.it:specificheTecniche:sco:730				
type	restriction of <a href="#">DatoNP_Type</a>				
facets	<table border="1"> <thead> <tr> <th>Kind</th> <th>Value</th> </tr> </thead> <tbody> <tr> <td>pattern</td> <td>[1-9]{1}[0-9]*</td> </tr> </tbody> </table>	Kind	Value	pattern	[1-9]{1}[0-9]*
Kind	Value				
pattern	[1-9]{1}[0-9]*				

#### element **Fabbricato\_Ord\_Type/PercPossesso**

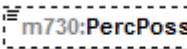
diagram	
---------	---

namespace	urn:www.agenziaentrate.gov.it:specificheTecniche:sco:730				
type	<a href="#">DatoPC_Type</a>				
facets	<table border="1"> <thead> <tr> <th>Kind</th> <th>Value</th> </tr> </thead> <tbody> <tr> <td>pattern</td> <td>[0-9]?[0-9](,\d{1,3})? 100,0{1,3}?</td> </tr> </tbody> </table>	Kind	Value	pattern	[0-9]?[0-9](,\d{1,3})? 100,0{1,3}?
Kind	Value				
pattern	[0-9]?[0-9](,\d{1,3})? 100,0{1,3}?				

#### element **Fabbricato\_Ord\_Type/CodiceCanone**

diagram													
namespace	urn:www.agenziaentrate.gov.it:specificheTecniche:sco:730												
type	<a href="#">m730:Codice Canone Type</a>												
facets	<table border="1"> <thead> <tr> <th>Kind</th> <th>Value</th> </tr> </thead> <tbody> <tr> <td>pattern</td> <td>[1-9]</td> </tr> <tr> <td>enumeration</td> <td>1</td> </tr> <tr> <td>enumeration</td> <td>2</td> </tr> <tr> <td>enumeration</td> <td>3</td> </tr> <tr> <td>enumeration</td> <td>4</td> </tr> </tbody> </table>	Kind	Value	pattern	[1-9]	enumeration	1	enumeration	2	enumeration	3	enumeration	4
Kind	Value												
pattern	[1-9]												
enumeration	1												
enumeration	2												
enumeration	3												
enumeration	4												

#### element **Fabbricato\_Ord\_Type/CanoneLocazione**

diagram					
namespace	urn:www.agenziaentrate.gov.it:specificheTecniche:sco:730				
type	<a href="#">DatoNP_Type</a>				
facets	<table border="1"> <thead> <tr> <th>Kind</th> <th>Value</th> </tr> </thead> <tbody> <tr> <td>pattern</td> <td>[1-9]{1}[0-9]*</td> </tr> </tbody> </table>	Kind	Value	pattern	[1-9]{1}[0-9]*
Kind	Value				
pattern	[1-9]{1}[0-9]*				

#### element **Fabbricato\_Ord\_Type/CasiParticolari**

diagram													
namespace	urn:www.agenziaentrate.gov.it:specificheTecniche:sco:730												
type	<a href="#">m730:Casi Particolari Fabbricato Type</a>												
facets	<table border="1"> <thead> <tr> <th>Kind</th> <th>Value</th> </tr> </thead> <tbody> <tr> <td>pattern</td> <td>[1-9]</td> </tr> <tr> <td>enumeration</td> <td>1</td> </tr> <tr> <td>enumeration</td> <td>3</td> </tr> <tr> <td>enumeration</td> <td>4</td> </tr> <tr> <td>enumeration</td> <td>5</td> </tr> </tbody> </table>	Kind	Value	pattern	[1-9]	enumeration	1	enumeration	3	enumeration	4	enumeration	5
Kind	Value												
pattern	[1-9]												
enumeration	1												
enumeration	3												
enumeration	4												
enumeration	5												

#### element **Fabbricato\_Ord\_Type/CasellaContinuazione**

diagram	
namespace	urn:www.agenziaentrate.gov.it:specificheTecniche:sco:730
type	<a href="#">DatoCB_Type</a>





complexType Familiari\_Type

diagram	
namespace	urn:www.agenziaentrate.gov.it:specificheTecniche:sco:730
children	<a href="#">m730:PrimoModulo</a> <a href="#">m730:Modulo</a>

element Familiari\_Type/PrimoModulo

diagram	
namespace	urn:www.agenziaentrate.gov.it:specificheTecniche:sco:730
type	<a href="#">m730:Primo_Modulo_Familiari_Type</a>
children	<a href="#">m730:Coniuge</a> <a href="#">m730:PrimoFiglio</a> <a href="#">m730:Familiari</a> <a href="#">m730:PercUlteriore</a> <a href="#">m730:FigliAffidoPread</a>

element Familiari\_Type/Modulo

diagram	
namespace	urn:www.agenziaentrate.gov.it:specificheTecniche:sco:730
type	<a href="#">m730:Modulo_Familiari_Type</a>
children	<a href="#">m730:Coniuge</a> <a href="#">m730:PrimoFiglio</a> <a href="#">m730:Familiari</a>

**complexType Firma\_Dichiarazione\_Type**

diagram	
namespace	urn:www.agenziaentrate.gov.it:specificheTecniche:sco:730
children	<a href="#">m730:NumeroModelli</a> <a href="#">m730:FirmaDichiarazione</a> <a href="#">m730:OpzioneInformativa</a> <a href="#">m730:SoggettoFiscalmenteCarico</a> <a href="#">m730:QuadroK</a>

**element Firma\_Dichiarazione\_Type/NumeroModelli**

diagram					
namespace	urn:www.agenziaentrate.gov.it:specificheTecniche:sco:730				
type	<a href="#">DatoNP_Type</a>				
facets	<table border="1"> <tr> <td>Kind</td> <td>Value</td> </tr> <tr> <td>pattern</td> <td>[1-9]{1}[0-9]*</td> </tr> </table>	Kind	Value	pattern	[1-9]{1}[0-9]*
Kind	Value				
pattern	[1-9]{1}[0-9]*				

**element Firma\_Dichiarazione\_Type/FirmaDichiarazione**

diagram					
namespace	urn:www.agenziaentrate.gov.it:specificheTecniche:sco:730				
type	<a href="#">DatoCB_Type</a>				
facets	<table border="1"> <tr> <td>Kind</td> <td>Value</td> </tr> <tr> <td>pattern</td> <td>[01]</td> </tr> </table>	Kind	Value	pattern	[01]
Kind	Value				
pattern	[01]				

**element Firma\_Dichiarazione\_Type/OpzioneInformativa**

diagram					
namespace	urn:www.agenziaentrate.gov.it:specificheTecniche:sco:730				
type	<a href="#">DatoCB_Type</a>				
facets	<table border="1"> <tr> <td>Kind</td> <td>Value</td> </tr> <tr> <td>pattern</td> <td>[01]</td> </tr> </table>	Kind	Value	pattern	[01]
Kind	Value				
pattern	[01]				

element **Firma\_Dichiarazione\_Type/SoggettoFiscalmenteCarico**

diagram	
namespace	urn:www.agenziaentrate.gov.it:specificheTecniche:sco:730
type	<a href="#">DatoCB_Type</a>
facets	Kind Value pattern [01]

element **Firma\_Dichiarazione\_Type/QuadroK**

diagram	
namespace	urn:www.agenziaentrate.gov.it:specificheTecniche:sco:730
type	<a href="#">DatoCB_Type</a>
facets	Kind Value pattern [01]

complexType **Fondo\_Pensione\_Dipendenti\_Pubblici\_Type**

diagram	
namespace	urn:www.agenziaentrate.gov.it:specificheTecniche:sco:730
children	<a href="#">m730:Contributi</a> <a href="#">m730:QuotaTFR</a>

element **Fondo\_Pensione\_Dipendenti\_Pubblici\_Type/Contributi**

diagram	
namespace	urn:www.agenziaentrate.gov.it:specificheTecniche:sco:730
type	<a href="#">m730:Contributi</a> <a href="#">Previdenza Complementare Type</a>
children	<a href="#">m730:EsclusiDalSostituto</a> <a href="#">m730:NonEsclusiDalSostituto</a>

element **Fondo\_Pensione\_Dipendenti\_Pubblici\_Type/QuotaTFR**

diagram	
---------	--

namespace	urn:www.agenziaentrate.gov.it:specificheTecniche:sco:730
type	<a href="#">DatoNP_Type</a>
facets	Kind Value pattern [1-9]{1}[0-9]*

### complexType Frontespizio\_730\_Type

diagram	
namespace	urn:www.agenziaentrate.gov.it:specificheTecniche:sco:730
children	<a href="#">m730:SoggettoFiscale</a> <a href="#">m730:DatiAnagrafici</a> <a href="#">m730:StatoCivile</a> <a href="#">m730:ResidenzaAnagrafica</a> <a href="#">m730:DomicilioFiscaleSaldo</a> <a href="#">m730:DomicilioFiscaleAcconto</a> <a href="#">m730:CasiParticolariAddizionale</a> <a href="#">m730:Firma</a>

### element Frontespizio\_730\_Type/SoggettoFiscale

diagram	
namespace	urn:www.agenziaentrate.gov.it:specificheTecniche:sco:730
type	<a href="#">m730:Soggetto_Fiscale_730_Type</a>
children	<a href="#">m730:CodiceFiscale</a> <a href="#">m730:Email</a> <a href="#">m730:Telefono</a> <a href="#">m730:Cellulare</a>

element **Frontespizio\_730\_Type/DatiAnagrafici**

diagram	
namespace	urn:www.agenziaentrate.gov.it:specificheTecniche:sco:730
type	<a href="#">Dati_Anagrafici_Type</a>
children	<a href="#">Cognome</a> <a href="#">Nome</a> <a href="#">Sesso</a> <a href="#">DataNascita</a> <a href="#">ComuneNascita</a> <a href="#">ProvinciaNascita</a>

element **Frontespizio\_730\_Type/StatoCivile**

diagram									
namespace	urn:www.agenziaentrate.gov.it:specificheTecniche:sco:730								
type	<a href="#">m730:Stato_Civile_Type</a>								
facets	<table border="1"> <thead> <tr> <th>Kind</th> <th>Value</th> </tr> </thead> <tbody> <tr> <td>pattern</td> <td>[1-9]{1}[0-9]*</td> </tr> <tr> <td>enumeration</td> <td>7</td> </tr> <tr> <td>enumeration</td> <td>8</td> </tr> </tbody> </table>	Kind	Value	pattern	[1-9]{1}[0-9]*	enumeration	7	enumeration	8
Kind	Value								
pattern	[1-9]{1}[0-9]*								
enumeration	7								
enumeration	8								

element Frontespizio\_730\_Type/ResidenzaAnagrafica

<p>diagram</p>	
<p>namespace</p>	<p>urn:www.agenziaentrate.gov.it:specificheTecniche:sco:730</p>
<p>type</p>	<p><a href="#">m730:Residenza_Anagrafica_730_Type</a></p>
<p>children</p>	<p><a href="#">Comune</a> <a href="#">Provincia</a> <a href="#">CodiceComune</a> <a href="#">Indirizzo</a> <a href="#">Cap</a> <a href="#">DataVariazione</a> <a href="#">m730:Tipologia</a> <a href="#">m730:NumCivico</a> <a href="#">m730:Frazione</a> <a href="#">m730:PrimaPresentazione</a></p>

element Frontespizio\_730\_Type/DomicilioFiscaleSaldo

<p>diagram</p>	
<p>namespace</p>	<p>urn:www.agenziaentrate.gov.it:specificheTecniche:sco:730</p>
<p>type</p>	<p><a href="#">m730:Domicilio_Fiscale_Type</a></p>
<p>children</p>	<p><a href="#">m730:Comune</a> <a href="#">m730:Provincia</a> <a href="#">m730:CodiceComune</a> <a href="#">m730:FusioneComuni</a></p>

element **Frontespizio\_730\_Type/DomicilioFiscaleAcconto**

diagram	
namespace	urn:www.agenziaentrate.gov.it:specificheTecniche:sco:730
type	<a href="#">m730:Domicilio_Fiscale_Type</a>
children	<a href="#">m730:Comune</a> <a href="#">m730:Provincia</a> <a href="#">m730:CodiceComune</a> <a href="#">m730:FusioneComuni</a>

element **Frontespizio\_730\_Type/CasiParticolariAddizionale**

diagram									
namespace	urn:www.agenziaentrate.gov.it:specificheTecniche:sco:730								
type	restriction of <a href="#">DatoN1_Type</a>								
facets	<table border="1"> <thead> <tr> <th>Kind</th> <th>Value</th> </tr> </thead> <tbody> <tr> <td>pattern</td> <td>[1-9]</td> </tr> <tr> <td>enumeration</td> <td>1</td> </tr> <tr> <td>enumeration</td> <td>2</td> </tr> </tbody> </table>	Kind	Value	pattern	[1-9]	enumeration	1	enumeration	2
Kind	Value								
pattern	[1-9]								
enumeration	1								
enumeration	2								

element **Frontespizio\_730\_Type/Firma**

diagram	
namespace	urn:www.agenziaentrate.gov.it:specificheTecniche:sco:730
type	<a href="#">m730:Firma_Dichiarazione_Type</a>
children	<a href="#">m730:NumeroModelli</a> <a href="#">m730:FirmaDichiarazione</a> <a href="#">m730:OpzioneInformativa</a> <a href="#">m730:SoggettoFiscalmenteCarico</a> <a href="#">m730:QuadroK</a>

complexType **Frontespizio\_Con\_Type**

<p>diagram</p>	<p>The diagram illustrates the structure of the <code>Frontespizio_Con_Type</code> complex type. It is an extension of the <code>m730:Frontespizio_730_Type</code>. The <code>Frontespizio_Con_Type</code> is represented by a rounded rectangle with a small square on its right side. A dashed line with a small square on its left side connects it to a larger rounded rectangle representing the extension. This extension is labeled <code>m730:Frontespizio_730_Type (extension)</code> and is enclosed in a dashed yellow box. Inside this box, eight elements are listed vertically, each in a rounded rectangle with a small square on its right side. From top to bottom, these are: <code>m730:SoggettoFiscale</code>, <code>m730:DatiAnagrafici</code>, <code>m730:StatoCivile</code>, <code>m730:ResidenzaAnagrafica</code>, <code>m730:DomicilioFiscaleSaldo</code>, <code>m730:DomicilioFiscaleAcconto</code>, <code>m730:CasiParticolariAddizionale</code>, and <code>m730:Firma</code>. The elements <code>m730:StatoCivile</code>, <code>m730:ResidenzaAnagrafica</code>, <code>m730:DomicilioFiscaleAcconto</code>, and <code>m730:CasiParticolariAddizionale</code> are shown with dashed borders, indicating they are inherited from the base type. The other elements have solid borders, indicating they are new to the extension.</p>
<p>namespace</p>	<p>urn:www.agenziaentrate.gov.it:specificheTecniche:sco:730</p>
<p>type</p>	<p>extension of <a href="#">m730:Frontespizio_730_Type</a></p>
<p>children</p>	<p><a href="#">m730:SoggettoFiscale</a> <a href="#">m730:DatiAnagrafici</a> <a href="#">m730:StatoCivile</a> <a href="#">m730:ResidenzaAnagrafica</a>  <a href="#">m730:DomicilioFiscaleSaldo</a> <a href="#">m730:DomicilioFiscaleAcconto</a> <a href="#">m730:CasiParticolariAddizionale</a> <a href="#">m730:Firma</a></p>



complexType Frontespizio\_Dich\_Type

diagram	
namespace	urn:www.agenziaentrate.gov.it:specificheTecniche:sco:730
type	extension of <a href="#">m730:Frontespizio_730_Type</a>
children	<a href="#">m730:SoggettoFiscale</a> <a href="#">m730:DatiAnagrafici</a> <a href="#">m730:StatoCivile</a> <a href="#">m730:ResidenzaAnagrafica</a> <a href="#">m730:DomicilioFiscaleSaldo</a> <a href="#">m730:DomicilioFiscaleAcconto</a> <a href="#">m730:CasiParticolariAddizionale</a> <a href="#">m730:Firma</a> <a href="#">m730:Rappresentante</a>

element Frontespizio\_Dich\_Type/Rappresentante

diagram	
namespace	urn:www.agenziaentrate.gov.it:specificheTecniche:sco:730
type	<a href="#">m730:Rappresentante_Type</a>
children	<a href="#">m730:SoggettoFiscale</a> <a href="#">m730:DatiAnagrafici</a> <a href="#">m730:ResidenzaAnagrafica</a> <a href="#">m730:Firma</a>

complexType **Fuori\_Assistenza\_Type**

diagram	
namespace	urn:www.agenziaentrate.gov.it:specificheTecniche:sco:730
children	<a href="#">m730:AnomaliaDatianagrafici</a> <a href="#">m730:AnomaliaTerreni</a> <a href="#">m730:AnomaliaFabbricati</a> <a href="#">m730:AnomaliaLavDip</a> <a href="#">m730:AnomaliaAltriRedditi</a> <a href="#">m730:AnomaliaQuadroF</a>

element **Fuori\_Assistenza\_Type/AnomaliaDatianagrafici**

diagram					
namespace	urn:www.agenziaentrate.gov.it:specificheTecniche:sco:730				
type	<a href="#">DatoCB_Type</a>				
facets	<table border="1"> <tr> <td>Kind</td> <td>Value</td> </tr> <tr> <td>pattern</td> <td>[01]</td> </tr> </table>	Kind	Value	pattern	[01]
Kind	Value				
pattern	[01]				

element **Fuori\_Assistenza\_Type/AnomaliaTerreni**

diagram					
namespace	urn:www.agenziaentrate.gov.it:specificheTecniche:sco:730				
type	<a href="#">DatoCB_Type</a>				
facets	<table border="1"> <tr> <td>Kind</td> <td>Value</td> </tr> <tr> <td>pattern</td> <td>[01]</td> </tr> </table>	Kind	Value	pattern	[01]
Kind	Value				
pattern	[01]				

element **Fuori\_Assistenza\_Type/AnomaliaFabbricati**

diagram					
namespace	urn:www.agenziaentrate.gov.it:specificheTecniche:sco:730				
type	<a href="#">DatoCB_Type</a>				
facets	<table border="1"> <tr> <td>Kind</td> <td>Value</td> </tr> <tr> <td>pattern</td> <td>[01]</td> </tr> </table>	Kind	Value	pattern	[01]
Kind	Value				
pattern	[01]				

**element Fuori\_Assistenza\_Type/AnomaliaLavDip**

diagram	
namespace	urn:www.agenziaentrate.gov.it:specificheTecniche:sco:730
type	<a href="#">DatoCB_Type</a>
facets	Kind Value pattern [01]

**element Fuori\_Assistenza\_Type/AnomaliaAltriRedditi**

diagram	
namespace	urn:www.agenziaentrate.gov.it:specificheTecniche:sco:730
type	<a href="#">DatoCB_Type</a>
facets	Kind Value pattern [01]

**element Fuori\_Assistenza\_Type/AnomaliaQuadroF**

diagram	
namespace	urn:www.agenziaentrate.gov.it:specificheTecniche:sco:730
type	<a href="#">DatoCB_Type</a>
facets	Kind Value pattern [01]

**complexType Giorni\_Percentuale\_Type**

diagram	
namespace	urn:www.agenziaentrate.gov.it:specificheTecniche:sco:730
children	<a href="#">m730:Giorni</a> <a href="#">m730:Percentuale</a>

**element Giorni\_Percentuale\_Type/Giorni**

diagram	
namespace	urn:www.agenziaentrate.gov.it:specificheTecniche:sco:730
type	<a href="#">DatoNP_Type</a>
facets	Kind Value pattern [1-9]{1}[0-9]*

element **Giorni\_Percentuale\_Type/Percentuale**

diagram	
namespace	urn:www.agenziaentrate.gov.it:specificheTecniche:sco:730
type	<a href="#">DatoPC Type</a>
facets	Kind Value pattern [0-9]?[0-9](,\.d(1,3))?[100,0(1,3)]?

complexType **Importi\_Rimborsare\_730-4\_Integrativo\_Type**

diagram	
namespace	urn:www.agenziaentrate.gov.it:specificheTecniche:sco:730
type	extension of <a href="#">m730:Importi_Rimborsare_730-4_Type</a>
children	<a href="#">m730:IrpefRimborsare</a> <a href="#">m730:AddRegRimborsare</a> <a href="#">m730:AddComRimborsare</a> <a href="#">m730:CedolareRimborsare</a> <a href="#">m730:TassazioneSepRimborsare</a> <a href="#">m730:PremiRisultatoRimborsare</a>

element **Importi\_Rimborsare\_730-4\_Integrativo\_Type/TassazioneSepRimborsare**

diagram	
namespace	urn:www.agenziaentrate.gov.it:specificheTecniche:sco:730
type	<a href="#">m730:Importo_730-4</a>
children	<a href="#">m730:ImportoDichiarante</a> <a href="#">m730:ImportoConiuge</a> <a href="#">m730:ImportoTotale</a>

element **Importi\_Rimborsare\_730-4\_Integrativo\_Type/PremiRisultatoRimborsare**

diagram	
namespace	urn:www.agenziaentrate.gov.it:specificheTecniche:sco:730
type	<a href="#">m730:Importo_730-4</a>
children	<a href="#">m730:ImportoDichiarante</a> <a href="#">m730:ImportoConiuge</a> <a href="#">m730:ImportoTotale</a>

complexType **Importi\_Rimborsare\_730-4\_Type**

diagram	
namespace	urn:www.agenziaentrate.gov.it:specificheTecniche:sco:730
children	<a href="#">m730:IrpefRimborsare</a> <a href="#">m730:AddRegRimborsare</a> <a href="#">m730:AddComRimborsare</a> <a href="#">m730:CedolareRimborsare</a>

element **Importi\_Rimborsare\_730-4\_Type/IrpefRimborsare**

diagram	
namespace	urn:www.agenziaentrate.gov.it:specificheTecniche:sco:730
type	<a href="#">m730:Importo_730-4</a>
children	<a href="#">m730:ImportoDichiarante</a> <a href="#">m730:ImportoConiuge</a> <a href="#">m730:ImportoTotale</a>

element **Importi\_Rimborsare\_730-4\_Type/AddRegRimborsare**

diagram	
namespace	urn:www.agenziaentrate.gov.it:specificheTecniche:sco:730
children	<a href="#">m730:ImportoAddizionale</a> <a href="#">m730:CodiceRegioneDichiarante</a> <a href="#">m730:CodiceRegioneConiuge</a>

element **Importi\_Rimborsare\_730-4\_Type/AddRegRimborsare/ImportoAddizionale**

diagram	
namespace	urn:www.agenziaentrate.gov.it:specificheTecniche:sco:730
type	<a href="#">m730:Importo_730-4</a>
children	<a href="#">m730:ImportoDichiarante</a> <a href="#">m730:ImportoConiuge</a> <a href="#">m730:ImportoTotale</a>

element **Importi\_Rimborsare\_730-4\_Type/AddRegRimborsare/CodiceRegioneDichiarante**

diagram																																									
namespace	urn:www.agenziaentrate.gov.it:specificheTecniche:sco:730																																								
type	<a href="#">Codice_Regione_Type</a>																																								
facets	<table border="1"> <thead> <tr> <th>Kind</th> <th>Value</th> </tr> </thead> <tbody> <tr> <td>pattern</td> <td>([0-9A-Z\-\_] &amp;quot;){1}([ 0-9A-Z&amp;amp;:] ' \- \-\. / ° \^\(\\) À È É Ì Ò Ù Û &amp;quot; \N \\+)*</td> </tr> <tr> <td>enumeration</td> <td>1</td> </tr> <tr> <td>enumeration</td> <td>2</td> </tr> <tr> <td>enumeration</td> <td>3</td> </tr> <tr> <td>enumeration</td> <td>4</td> </tr> <tr> <td>enumeration</td> <td>5</td> </tr> <tr> <td>enumeration</td> <td>6</td> </tr> <tr> <td>enumeration</td> <td>7</td> </tr> <tr> <td>enumeration</td> <td>8</td> </tr> <tr> <td>enumeration</td> <td>9</td> </tr> <tr> <td>enumeration</td> <td>10</td> </tr> <tr> <td>enumeration</td> <td>11</td> </tr> <tr> <td>enumeration</td> <td>12</td> </tr> <tr> <td>enumeration</td> <td>13</td> </tr> <tr> <td>enumeration</td> <td>14</td> </tr> <tr> <td>enumeration</td> <td>15</td> </tr> <tr> <td>enumeration</td> <td>16</td> </tr> <tr> <td>enumeration</td> <td>17</td> </tr> <tr> <td>enumeration</td> <td>18</td> </tr> </tbody> </table>	Kind	Value	pattern	([0-9A-Z\-\_] &quot;){1}([ 0-9A-Z&amp;:] ' \- \-\. / ° \^\(\\) À È É Ì Ò Ù Û &quot; \N \\+)*	enumeration	1	enumeration	2	enumeration	3	enumeration	4	enumeration	5	enumeration	6	enumeration	7	enumeration	8	enumeration	9	enumeration	10	enumeration	11	enumeration	12	enumeration	13	enumeration	14	enumeration	15	enumeration	16	enumeration	17	enumeration	18
Kind	Value																																								
pattern	([0-9A-Z\-\_] &quot;){1}([ 0-9A-Z&amp;:] ' \- \-\. / ° \^\(\\) À È É Ì Ò Ù Û &quot; \N \\+)*																																								
enumeration	1																																								
enumeration	2																																								
enumeration	3																																								
enumeration	4																																								
enumeration	5																																								
enumeration	6																																								
enumeration	7																																								
enumeration	8																																								
enumeration	9																																								
enumeration	10																																								
enumeration	11																																								
enumeration	12																																								
enumeration	13																																								
enumeration	14																																								
enumeration	15																																								
enumeration	16																																								
enumeration	17																																								
enumeration	18																																								

	enumeration	19
	enumeration	20
	enumeration	21

element **Importi\_Rimborsare\_730-4\_Type/AddRegRimborsare/CodiceRegioneConiuge**

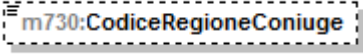
diagram		
namespace	urn:www.agenziaentrate.gov.it:specificheTecniche:sco:730	
type	<a href="#">Codice Regione Type</a>	
facets	Kind	Value
	pattern	([0-9A-Z\-\-] \&quot;){1}([ 0-9A-Z&amp;:] ' \- \., / ° ^\ \\( \) À É È Ì Ò Ù Û &quot; \ \\ +)*
	enumeration	1
	enumeration	2
	enumeration	3
	enumeration	4
	enumeration	5
	enumeration	6
	enumeration	7
	enumeration	8
	enumeration	9
	enumeration	10
	enumeration	11
	enumeration	12
	enumeration	13
	enumeration	14
	enumeration	15
	enumeration	16
	enumeration	17
	enumeration	18
	enumeration	19
	enumeration	20
	enumeration	21

element **Importi\_Rimborsare\_730-4\_Type/AddComRimborsare**

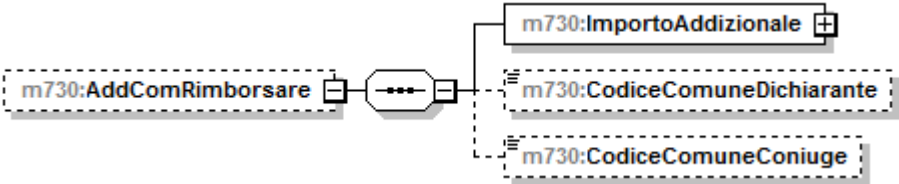
diagram		
namespace	urn:www.agenziaentrate.gov.it:specificheTecniche:sco:730	
children	<a href="#">m730:ImportoAddizionale</a> <a href="#">m730:CodiceComuneDichiarante</a> <a href="#">m730:CodiceComuneConiuge</a>	

element **Importi\_Rimborsare\_730-4\_Type/AddComRimborsare/ImportoAddizionale**

diagram	
namespace	urn:www.agenziaentrate.gov.it:specificheTecniche:sco:730
type	<a href="#">m730:Importo_730-4</a>
children	<a href="#">m730:ImportoDichiarante</a> <a href="#">m730:ImportoConiuge</a> <a href="#">m730:ImportoTotale</a>

element **Importi\_Rimborsare\_730-4\_Type/AddComRimborsare/CodiceComuneDichiarante**

diagram					
namespace	urn:www.agenziaentrate.gov.it:specificheTecniche:sco:730				
type	<a href="#">DatoAN_Type</a>				
facets	<table border="1"> <thead> <tr> <th>Kind</th> <th>Value</th> </tr> </thead> <tbody> <tr> <td>pattern</td> <td>(([0-9A-Z-] &amp;quot;){1}([ 0-9A-Z&amp;amp;] ' - \., / ^ \(\) \) À É È Ì Ò Ù Û &amp;quot; \ \\ \ +)*</td> </tr> </tbody> </table>	Kind	Value	pattern	(([0-9A-Z-] &quot;){1}([ 0-9A-Z&amp;] ' - \., / ^ \(\) \) À É È Ì Ò Ù Û &quot; \ \\ \ +)*
Kind	Value				
pattern	(([0-9A-Z-] &quot;){1}([ 0-9A-Z&amp;] ' - \., / ^ \(\) \) À É È Ì Ò Ù Û &quot; \ \\ \ +)*				

element **Importi\_Rimborsare\_730-4\_Type/AddComRimborsare/CodiceComuneConiuge**

diagram					
namespace	urn:www.agenziaentrate.gov.it:specificheTecniche:sco:730				
type	<a href="#">DatoAN_Type</a>				
facets	<table border="1"> <thead> <tr> <th>Kind</th> <th>Value</th> </tr> </thead> <tbody> <tr> <td>pattern</td> <td>(([0-9A-Z-] &amp;quot;){1}([ 0-9A-Z&amp;amp;] ' - \., / ^ \(\) \) À É È Ì Ò Ù Û &amp;quot; \ \\ \ +)*</td> </tr> </tbody> </table>	Kind	Value	pattern	(([0-9A-Z-] &quot;){1}([ 0-9A-Z&amp;] ' - \., / ^ \(\) \) À É È Ì Ò Ù Û &quot; \ \\ \ +)*
Kind	Value				
pattern	(([0-9A-Z-] &quot;){1}([ 0-9A-Z&amp;] ' - \., / ^ \(\) \) À É È Ì Ò Ù Û &quot; \ \\ \ +)*				

element **Importi\_Rimborsare\_730-4\_Type/CedolareRimborsare**

diagram	
namespace	urn:www.agenziaentrate.gov.it:specificheTecniche:sco:730
type	<a href="#">m730:Importo_730-4</a>



children	<a href="#">m730:ImportoDichiarante</a> <a href="#">m730:ImportoConiuge</a> <a href="#">m730:ImportoTotale</a>
----------	--

### complexType **Importi\_Trattenere\_730-4\_Type**

diagram	
namespace	urn:www.agenziaentrate.gov.it:specificheTecniche:sco:730
children	<a href="#">m730:lrpefTrattenere</a> <a href="#">m730:AddRegTrattenere</a> <a href="#">m730:AddComTrattenere</a> <a href="#">m730:lrpefPrimaRataTrattenere</a> <a href="#">m730:lrpefSecondaRataTrattenere</a> <a href="#">m730:TassSepAccontoTrattenere</a> <a href="#">m730:AddComAccontoTrattenere</a> <a href="#">m730:PremiRisultatoTrattenere</a> <a href="#">m730:CedolareTrattenere</a> <a href="#">m730:CedolarePrimaRataTrattenere</a> <a href="#">m730:CedolareSecondaRataTrattenere</a>

### element **Importi\_Trattenere\_730-4\_Type/lrpefTrattenere**

diagram	
namespace	urn:www.agenziaentrate.gov.it:specificheTecniche:sco:730
type	<a href="#">m730:Importo_730-4</a>
children	<a href="#">m730:ImportoDichiarante</a> <a href="#">m730:ImportoConiuge</a> <a href="#">m730:ImportoTotale</a>

element **Importi\_Trattenere\_730-4\_Type/AddRegTrattenere**

diagram	
namespace	urn:www.agenziaentrate.gov.it:specificheTecniche:sco:730
children	<a href="#">m730:ImportoAddizionale</a> <a href="#">m730:CodiceRegioneDichiarante</a> <a href="#">m730:CodiceRegioneConiuge</a>

element **Importi\_Trattenere\_730-4\_Type/AddRegTrattenere/ImportoAddizionale**

diagram	
namespace	urn:www.agenziaentrate.gov.it:specificheTecniche:sco:730
type	<a href="#">m730:Importo_730-4</a>
children	<a href="#">m730:ImportoDichiarante</a> <a href="#">m730:ImportoConiuge</a> <a href="#">m730:ImportoTotale</a>

element **Importi\_Trattenere\_730-4\_Type/AddRegTrattenere/CodiceRegioneDichiarante**

diagram																																					
namespace	urn:www.agenziaentrate.gov.it:specificheTecniche:sco:730																																				
type	<a href="#">Codice Regione Type</a>																																				
facets	<table border="1"> <thead> <tr> <th>Kind</th> <th>Value</th> </tr> </thead> <tbody> <tr> <td>pattern</td> <td>{([0-9A-Z-])&amp;quot;}{1}([ 0-9A-Z&amp;amp; ' - \- .  ° ^\(\\ \\) À È É ì ò ù Ü &amp;quot; \\ \\ +)*</td> </tr> <tr> <td>enumeration</td> <td>1</td> </tr> <tr> <td>enumeration</td> <td>2</td> </tr> <tr> <td>enumeration</td> <td>3</td> </tr> <tr> <td>enumeration</td> <td>4</td> </tr> <tr> <td>enumeration</td> <td>5</td> </tr> <tr> <td>enumeration</td> <td>6</td> </tr> <tr> <td>enumeration</td> <td>7</td> </tr> <tr> <td>enumeration</td> <td>8</td> </tr> <tr> <td>enumeration</td> <td>9</td> </tr> <tr> <td>enumeration</td> <td>10</td> </tr> <tr> <td>enumeration</td> <td>11</td> </tr> <tr> <td>enumeration</td> <td>12</td> </tr> <tr> <td>enumeration</td> <td>13</td> </tr> <tr> <td>enumeration</td> <td>14</td> </tr> <tr> <td>enumeration</td> <td>15</td> </tr> <tr> <td>enumeration</td> <td>16</td> </tr> </tbody> </table>	Kind	Value	pattern	{([0-9A-Z-])&quot;}{1}([ 0-9A-Z&amp; ' - \- .  ° ^\(\\ \\) À È É ì ò ù Ü &quot; \\ \\ +)*	enumeration	1	enumeration	2	enumeration	3	enumeration	4	enumeration	5	enumeration	6	enumeration	7	enumeration	8	enumeration	9	enumeration	10	enumeration	11	enumeration	12	enumeration	13	enumeration	14	enumeration	15	enumeration	16
Kind	Value																																				
pattern	{([0-9A-Z-])&quot;}{1}([ 0-9A-Z&amp; ' - \- .  ° ^\(\\ \\) À È É ì ò ù Ü &quot; \\ \\ +)*																																				
enumeration	1																																				
enumeration	2																																				
enumeration	3																																				
enumeration	4																																				
enumeration	5																																				
enumeration	6																																				
enumeration	7																																				
enumeration	8																																				
enumeration	9																																				
enumeration	10																																				
enumeration	11																																				
enumeration	12																																				
enumeration	13																																				
enumeration	14																																				
enumeration	15																																				
enumeration	16																																				

enumeration	17
enumeration	18
enumeration	19
enumeration	20
enumeration	21

element **Importi\_Trattenere\_730-4\_Type/AddRegTrattenere/CodiceRegioneConiuge**

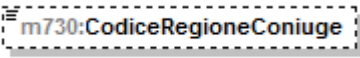
diagram		
namespace	urn:www.agenziaentrate.gov.it:specificheTecniche:sco:730	
type	<a href="#">Codice Regione Type</a>	
facets	Kind	Value
	pattern	{([0-9A-Z-])&quot;}{1}([ 0-9A-Z&amp;:] [-\., /° ^\\( \) À È É Ì Ò Ù Û &quot; \\ \\+)*
	enumeration	1
	enumeration	2
	enumeration	3
	enumeration	4
	enumeration	5
	enumeration	6
	enumeration	7
	enumeration	8
	enumeration	9
	enumeration	10
	enumeration	11
	enumeration	12
	enumeration	13
	enumeration	14
	enumeration	15
	enumeration	16
	enumeration	17
	enumeration	18
	enumeration	19
	enumeration	20
	enumeration	21

element **Importi\_Trattenere\_730-4\_Type/AddComTrattenere**

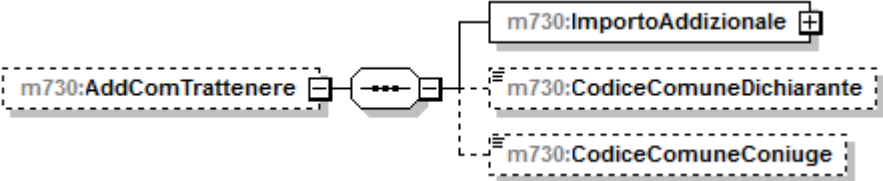
diagram		
namespace	urn:www.agenziaentrate.gov.it:specificheTecniche:sco:730	
children	<a href="#">m730:ImportoAddizionale</a> <a href="#">m730:CodiceComuneDichiarante</a> <a href="#">m730:CodiceComuneConiuge</a>	

element **Importi\_Trattenere\_730-4\_Type/AddComTrattenere/ImportoAddizionale**

diagram	
namespace	urn:www.agenziaentrate.gov.it:specificheTecniche:sco:730
type	<a href="#">m730:Importo_730-4</a>
children	<a href="#">m730:ImportoDichiarante</a> <a href="#">m730:ImportoConiuge</a> <a href="#">m730:ImportoTotale</a>

element **Importi\_Trattenere\_730-4\_Type/AddComTrattenere/CodiceComuneDichiarante**

diagram					
namespace	urn:www.agenziaentrate.gov.it:specificheTecniche:sco:730				
type	<a href="#">DatoAN_Type</a>				
facets	<table border="1"> <thead> <tr> <th>Kind</th> <th>Value</th> </tr> </thead> <tbody> <tr> <td>pattern</td> <td>(([0-9A-Z-] \&amp;quot;){1}([ 0-9A-Z&amp;amp;] '\- \., / ^ \(\) \) \) \&amp;Egrave; \&amp;Ecirc; \&amp;Ograve; \&amp;Ugrave; \&amp;Ucirc; \&amp;quot; \ \\ \ +)*</td> </tr> </tbody> </table>	Kind	Value	pattern	(([0-9A-Z-] \&quot;){1}([ 0-9A-Z&amp;] '\- \., / ^ \(\) \) \) \&Egrave; \&Ecirc; \&Ograve; \&Ugrave; \&Ucirc; \&quot; \ \\ \ +)*
Kind	Value				
pattern	(([0-9A-Z-] \&quot;){1}([ 0-9A-Z&amp;] '\- \., / ^ \(\) \) \) \&Egrave; \&Ecirc; \&Ograve; \&Ugrave; \&Ucirc; \&quot; \ \\ \ +)*				

element **Importi\_Trattenere\_730-4\_Type/AddComTrattenere/CodiceComuneConiuge**

diagram					
namespace	urn:www.agenziaentrate.gov.it:specificheTecniche:sco:730				
type	<a href="#">DatoAN_Type</a>				
facets	<table border="1"> <thead> <tr> <th>Kind</th> <th>Value</th> </tr> </thead> <tbody> <tr> <td>pattern</td> <td>(([0-9A-Z-] \&amp;quot;){1}([ 0-9A-Z&amp;amp;] '\- \., / ^ \(\) \) \) \&amp;Egrave; \&amp;Ecirc; \&amp;Ograve; \&amp;Ugrave; \&amp;Ucirc; \&amp;quot; \ \\ \ +)*</td> </tr> </tbody> </table>	Kind	Value	pattern	(([0-9A-Z-] \&quot;){1}([ 0-9A-Z&amp;] '\- \., / ^ \(\) \) \) \&Egrave; \&Ecirc; \&Ograve; \&Ugrave; \&Ucirc; \&quot; \ \\ \ +)*
Kind	Value				
pattern	(([0-9A-Z-] \&quot;){1}([ 0-9A-Z&amp;] '\- \., / ^ \(\) \) \) \&Egrave; \&Ecirc; \&Ograve; \&Ugrave; \&Ucirc; \&quot; \ \\ \ +)*				

element **Importi\_Trattenere\_730-4\_Type/IrpefPrimaRataTrattenere**

diagram	
namespace	urn:www.agenziaentrate.gov.it:specificheTecniche:sco:730
type	<a href="#">m730:Importo_730-4</a>

children	<a href="#">m730:ImportoDichiarante</a> <a href="#">m730:ImportoConiuge</a> <a href="#">m730:ImportoTotale</a>
----------	--

element **Importi\_Trattenere\_730-4\_Type/lrpefSecondaRataTrattenere**

diagram	
namespace	urn:www.agenziaentrate.gov.it:specificheTecniche:sco:730
type	<a href="#">m730:Importo_730-4</a>
children	<a href="#">m730:ImportoDichiarante</a> <a href="#">m730:ImportoConiuge</a> <a href="#">m730:ImportoTotale</a>

element **Importi\_Trattenere\_730-4\_Type/TassSepAccontoTrattenere**

diagram	
namespace	urn:www.agenziaentrate.gov.it:specificheTecniche:sco:730
type	<a href="#">m730:Importo_730-4</a>
children	<a href="#">m730:ImportoDichiarante</a> <a href="#">m730:ImportoConiuge</a> <a href="#">m730:ImportoTotale</a>

element **Importi\_Trattenere\_730-4\_Type/AddComAccontoTrattenere**

diagram	
namespace	urn:www.agenziaentrate.gov.it:specificheTecniche:sco:730
children	<a href="#">m730:ImportoAddizionale</a> <a href="#">m730:CodiceComuneDichiarante</a> <a href="#">m730:CodiceComuneConiuge</a>



children	<a href="#">m730:ImportoDichiarante</a> <a href="#">m730:ImportoConiuge</a> <a href="#">m730:ImportoTotale</a>
----------	--

element **Importi\_Trattenere\_730-4\_Type/CedolareTrattenere**

diagram	<p>The diagram illustrates the composition of the <code>m730:Importo_730-4</code> element. It is shown as a large dashed box containing three sub-elements: <code>m730:ImportoDichiarante</code>, <code>m730:ImportoConiuge</code>, and <code>m730:ImportoTotale</code>. To the left, a dashed box labeled <code>m730:CedolareTrattenere</code> is connected to the main structure via a connector symbol.</p>
namespace	urn:www.agenziaentrate.gov.it:specificheTecniche:sco:730
type	<a href="#">m730:Importo_730-4</a>
children	<a href="#">m730:ImportoDichiarante</a> <a href="#">m730:ImportoConiuge</a> <a href="#">m730:ImportoTotale</a>

element **Importi\_Trattenere\_730-4\_Type/CedolarePrimaRataTrattenere**

diagram	<p>The diagram illustrates the composition of the <code>m730:Importo_730-4</code> element. It is shown as a large dashed box containing three sub-elements: <code>m730:ImportoDichiarante</code>, <code>m730:ImportoConiuge</code>, and <code>m730:ImportoTotale</code>. To the left, a dashed box labeled <code>m730:CedolarePrimaRataTrattenere</code> is connected to the main structure via a connector symbol.</p>
namespace	urn:www.agenziaentrate.gov.it:specificheTecniche:sco:730
type	<a href="#">m730:Importo_730-4</a>
children	<a href="#">m730:ImportoDichiarante</a> <a href="#">m730:ImportoConiuge</a> <a href="#">m730:ImportoTotale</a>

element **Importi\_Trattenere\_730-4\_Type/CedolareSecondaRataTrattenere**

diagram	<p>The diagram illustrates the composition of the <code>m730:Importo_730-4</code> element. It is shown as a large dashed box containing three sub-elements: <code>m730:ImportoDichiarante</code>, <code>m730:ImportoConiuge</code>, and <code>m730:ImportoTotale</code>. To the left, a dashed box labeled <code>m730:CedolareSecondaRataTrattenere</code> is connected to the main structure via a connector symbol.</p>
namespace	urn:www.agenziaentrate.gov.it:specificheTecniche:sco:730
type	<a href="#">m730:Importo_730-4</a>

children	<a href="#">m730:ImportoDichiarante</a> <a href="#">m730:ImportoConiuge</a> <a href="#">m730:ImportoTotale</a>
----------	--

#### complexType **Importo\_730-4**

diagram	
namespace	urn:www.agenziaentrate.gov.it:specificheTecniche:sco:730
children	<a href="#">m730:ImportoDichiarante</a> <a href="#">m730:ImportoConiuge</a> <a href="#">m730:ImportoTotale</a>

#### element **Importo\_730-4/ImportoDichiarante**

diagram					
namespace	urn:www.agenziaentrate.gov.it:specificheTecniche:sco:730				
type	<a href="#">DatoNP_Type</a>				
facets	<table border="1"> <tr> <td>Kind</td> <td>Value</td> </tr> <tr> <td>pattern</td> <td>[1-9]{1}[0-9]*</td> </tr> </table>	Kind	Value	pattern	[1-9]{1}[0-9]*
Kind	Value				
pattern	[1-9]{1}[0-9]*				

#### element **Importo\_730-4/ImportoConiuge**

diagram					
namespace	urn:www.agenziaentrate.gov.it:specificheTecniche:sco:730				
type	<a href="#">DatoNP_Type</a>				
facets	<table border="1"> <tr> <td>Kind</td> <td>Value</td> </tr> <tr> <td>pattern</td> <td>[1-9]{1}[0-9]*</td> </tr> </table>	Kind	Value	pattern	[1-9]{1}[0-9]*
Kind	Value				
pattern	[1-9]{1}[0-9]*				

#### element **Importo\_730-4/ImportoTotale**

diagram					
namespace	urn:www.agenziaentrate.gov.it:specificheTecniche:sco:730				
type	<a href="#">DatoNP_Type</a>				
facets	<table border="1"> <tr> <td>Kind</td> <td>Value</td> </tr> <tr> <td>pattern</td> <td>[1-9]{1}[0-9]*</td> </tr> </table>	Kind	Value	pattern	[1-9]{1}[0-9]*
Kind	Value				
pattern	[1-9]{1}[0-9]*				



complexType **Imposta\_Lorda\_Type**

diagram	
namespace	urn:www.agenziaentrate.gov.it:specificheTecniche:sco:730
children	<a href="#">m730:RedditoComplessivo</a> <a href="#">m730:DeduzioneAbitazPrincipale</a> <a href="#">m730:OneriDeducibili</a> <a href="#">m730:RedditoImponibile</a> <a href="#">m730:CompensiAttSport</a> <a href="#">m730:ImportoImpostaLorda</a>

element **Imposta\_Lorda\_Type/RedditoComplessivo**

diagram					
namespace	urn:www.agenziaentrate.gov.it:specificheTecniche:sco:730				
type	<a href="#">DatoNP_Type</a>				
facets	<table border="1"> <tr> <td>Kind</td> <td>Value</td> </tr> <tr> <td>pattern</td> <td>[1-9]{1}[0-9]*</td> </tr> </table>	Kind	Value	pattern	[1-9]{1}[0-9]*
Kind	Value				
pattern	[1-9]{1}[0-9]*				

element **Imposta\_Lorda\_Type/DeduzioneAbitazPrincipale**

diagram					
namespace	urn:www.agenziaentrate.gov.it:specificheTecniche:sco:730				
type	<a href="#">DatoNP_Type</a>				
facets	<table border="1"> <tr> <td>Kind</td> <td>Value</td> </tr> <tr> <td>pattern</td> <td>[1-9]{1}[0-9]*</td> </tr> </table>	Kind	Value	pattern	[1-9]{1}[0-9]*
Kind	Value				
pattern	[1-9]{1}[0-9]*				

element **Imposta\_Lorda\_Type/OneriDeducibili**

diagram					
namespace	urn:www.agenziaentrate.gov.it:specificheTecniche:sco:730				
type	<a href="#">DatoNP_Type</a>				
facets	<table border="1"> <tr> <td>Kind</td> <td>Value</td> </tr> <tr> <td>pattern</td> <td>[1-9]{1}[0-9]*</td> </tr> </table>	Kind	Value	pattern	[1-9]{1}[0-9]*
Kind	Value				
pattern	[1-9]{1}[0-9]*				

element **Imposta\_Lorda\_Type/Redditolmponibile**

diagram	 m730:Redditolmponibile
namespace	urn:www.agenziaentrate.gov.it:specificheTecniche:sco:730
type	<a href="#">DatoNP_Type</a>
facets	Kind Value pattern [1-9]{1}[0-9]*

element **Imposta\_Lorda\_Type/CompensiAttSport**

diagram	 m730:CompensiAttSport
namespace	urn:www.agenziaentrate.gov.it:specificheTecniche:sco:730
type	<a href="#">DatoNP_Type</a>
facets	Kind Value pattern [1-9]{1}[0-9]*

element **Imposta\_Lorda\_Type/ImportolmpostaLorda**

diagram	 m730:ImportolmpostaLorda
namespace	urn:www.agenziaentrate.gov.it:specificheTecniche:sco:730
type	<a href="#">DatoNP_Type</a>
facets	Kind Value pattern [1-9]{1}[0-9]*

complexType **Imposta\_Netta\_Type**

<p>diagram</p>	
<p>namespace</p>	<p>urn:www.agenziaentrate.gov.it:specificheTecniche:sco:730</p>
<p>children</p>	<p><a href="#">m730:ImportoImpostaNetta</a> <a href="#">m730:CredAltriSisma</a> <a href="#">m730:CredAbitazSisma</a> <a href="#">m730:CredImpEstere</a>  <a href="#">m730:CredErogCultura</a> <a href="#">m730:CredErogScuola</a> <a href="#">m730:CredVideosorveglianza</a> <a href="#">m730:CredCanNonPerc</a>  <a href="#">m730:CredDetrazIncapienti</a> <a href="#">m730:Ritenute</a> <a href="#">m730:Differenza</a> <a href="#">m730:EccedenzaIrpef</a> <a href="#">m730:AccontiVersati</a>  <a href="#">m730:RestituzioneBonus</a> <a href="#">m730:CredRimborsatiSost</a> <a href="#">m730:BonusIrpefSpettante</a> <a href="#">m730:BonusIrpefRiconosciuto</a>  <a href="#">m730:RestituzioneBonusIrpef</a></p>

element **Imposta\_Netta\_Type/ImportoImpostaNetta**

<p>diagram</p>	
<p>namespace</p>	<p>urn:www.agenziaentrate.gov.it:specificheTecniche:sco:730</p>

type	<a href="#">DatoNP_Type</a>
facets	Kind Value pattern [1-9]{1}[0-9]*

#### element **Imposta\_Netta\_Type/CredAltriSisma**

diagram	
namespace	urn:www.agenziaentrate.gov.it:specificheTecniche:sco:730
type	<a href="#">DatoNP_Type</a>
facets	Kind Value pattern [1-9]{1}[0-9]*

#### element **Imposta\_Netta\_Type/CredAbitazSisma**

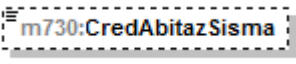
diagram	
namespace	urn:www.agenziaentrate.gov.it:specificheTecniche:sco:730
type	<a href="#">DatoNP_Type</a>
facets	Kind Value pattern [1-9]{1}[0-9]*

#### element **Imposta\_Netta\_Type/CredImpEstere**

diagram	
namespace	urn:www.agenziaentrate.gov.it:specificheTecniche:sco:730
type	<a href="#">DatoNP_Type</a>
facets	Kind Value pattern [1-9]{1}[0-9]*

#### element **Imposta\_Netta\_Type/CredErogCultura**

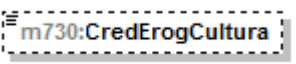
diagram	
namespace	urn:www.agenziaentrate.gov.it:specificheTecniche:sco:730
type	<a href="#">DatoNP_Type</a>
facets	Kind Value pattern [1-9]{1}[0-9]*

#### element **Imposta\_Netta\_Type/CredErogScuola**

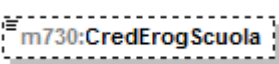
diagram	
---------	---

namespace	urn:www.agenziaentrate.gov.it:specificheTecniche:sco:730
type	<a href="#">DatoNP_Type</a>
facets	Kind Value pattern [1-9]{1}[0-9]*

#### element **Imposta\_Netta\_Type/CredVideosorveglianza**

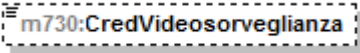
diagram	
namespace	urn:www.agenziaentrate.gov.it:specificheTecniche:sco:730
type	<a href="#">DatoNP_Type</a>
facets	Kind Value pattern [1-9]{1}[0-9]*

#### element **Imposta\_Netta\_Type/CredCanNonPerc**

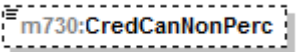
diagram	
namespace	urn:www.agenziaentrate.gov.it:specificheTecniche:sco:730
type	<a href="#">DatoNP_Type</a>
facets	Kind Value pattern [1-9]{1}[0-9]*

#### element **Imposta\_Netta\_Type/CredDetrazIncapienti**

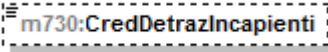
diagram	
namespace	urn:www.agenziaentrate.gov.it:specificheTecniche:sco:730
type	<a href="#">DatoNP_Type</a>
facets	Kind Value pattern [1-9]{1}[0-9]*

#### element **Imposta\_Netta\_Type/Ritenute**

diagram	
namespace	urn:www.agenziaentrate.gov.it:specificheTecniche:sco:730
type	<a href="#">DatoNP_Type</a>
facets	Kind Value pattern [1-9]{1}[0-9]*

**element Imposta\_Netta\_Type/Differenza**

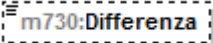
diagram	
namespace	urn:www.agenziaentrate.gov.it:specificheTecniche:sco:730
type	<a href="#">DatoNU_Type</a>
facets	Kind Value pattern $(\{-[1-9]\}\{1-9\})[0-9]^*$

**element Imposta\_Netta\_Type/Eccedenzalrpef**

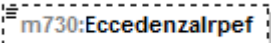
diagram	
namespace	urn:www.agenziaentrate.gov.it:specificheTecniche:sco:730
type	<a href="#">DatoNU_Type</a>
facets	Kind Value pattern $(\{-[1-9]\}\{1-9\})[0-9]^*$

**element Imposta\_Netta\_Type/AccontiVersati**

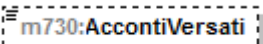
diagram	
namespace	urn:www.agenziaentrate.gov.it:specificheTecniche:sco:730
type	<a href="#">DatoNP_Type</a>
facets	Kind Value pattern $[1-9]\{1\}[0-9]^*$

**element Imposta\_Netta\_Type/RestituzioneBonus**

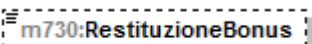
diagram	
namespace	urn:www.agenziaentrate.gov.it:specificheTecniche:sco:730
type	<a href="#">DatoNP_Type</a>
facets	Kind Value pattern $[1-9]\{1\}[0-9]^*$

**element Imposta\_Netta\_Type/CredRimborsatiSost**

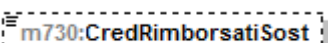
diagram	
namespace	urn:www.agenziaentrate.gov.it:specificheTecniche:sco:730
type	<a href="#">DatoNP_Type</a>
facets	Kind Value pattern $[1-9]\{1\}[0-9]^*$

element **Imposta\_Netta\_Type/BonuslrpefSpettante**

diagram	
namespace	urn:www.agenziaentrate.gov.it:specificheTecniche:sco:730
type	<a href="#">DatoNP_Type</a>
facets	Kind Value pattern [1-9]{1}[0-9]*

element **Imposta\_Netta\_Type/BonuslrpefRiconosciuto**

diagram	
namespace	urn:www.agenziaentrate.gov.it:specificheTecniche:sco:730
type	<a href="#">DatoNP_Type</a>
facets	Kind Value pattern [1-9]{1}[0-9]*

element **Imposta\_Netta\_Type/RestituzioneBonuslrpef**

diagram	
namespace	urn:www.agenziaentrate.gov.it:specificheTecniche:sco:730
type	<a href="#">DatoNP_Type</a>
facets	Kind Value pattern [1-9]{1}[0-9]*

complexType **Imposte\_Rimborsate\_Type**

diagram	
namespace	urn:www.agenziaentrate.gov.it:specificheTecniche:sco:730
children	<a href="#">m730:TipoReddito</a> <a href="#">m730:TassazioneSeparata</a>

element **Imposte\_Rimborsate\_Type/TipoReddito**

diagram	
namespace	urn:www.agenziaentrate.gov.it:specificheTecniche:sco:730
type	<a href="#">m730:Tipo_Reddito_Da1a8_Type</a>
facets	Kind Value pattern [1-9]{1}[0-9]*

	enumeration	1
	enumeration	2
	enumeration	3
	enumeration	4
	enumeration	5
	enumeration	6
	enumeration	7
	enumeration	8

**element Imposte\_Rimborsate\_Type/TassazioneSeparata**

diagram	
namespace	urn:www.agenziaentrate.gov.it:specificheTecniche:sco:730
type	<a href="#">m730:Tassazione_Separata_Type</a>
children	<a href="#">m730:Opzione</a> <a href="#">m730:Anno</a> <a href="#">m730:RedditoRitenute</a>

**complexType Inquilini\_Abitazione\_Principale\_Type**

diagram	
namespace	urn:www.agenziaentrate.gov.it:specificheTecniche:sco:730
children	<a href="#">m730:Tipologia</a> <a href="#">m730:GiorniPercentuale</a>

**element Inquilini\_Abitazione\_Principale\_Type/Tipologia**

diagram											
namespace	urn:www.agenziaentrate.gov.it:specificheTecniche:sco:730										
type	<a href="#">m730:Tipo_Inquilino_Type</a>										
facets	<table border="1"> <thead> <tr> <th>Kind</th> <th>Value</th> </tr> </thead> <tbody> <tr> <td>pattern</td> <td>[1-9]{1}[0-9]*</td> </tr> <tr> <td>enumeration</td> <td>1</td> </tr> <tr> <td>enumeration</td> <td>2</td> </tr> <tr> <td>enumeration</td> <td>3</td> </tr> </tbody> </table>	Kind	Value	pattern	[1-9]{1}[0-9]*	enumeration	1	enumeration	2	enumeration	3
Kind	Value										
pattern	[1-9]{1}[0-9]*										
enumeration	1										
enumeration	2										
enumeration	3										



element **Inquilini\_Abitazione\_Principale\_Type/GiorniPercentuale**

diagram	<p>The diagram shows a box labeled 'm730:GiorniPercentuale' connected to a sequence container (a rounded rectangle with three dots). This sequence container is connected to two child elements: 'm730:Giorni' and 'm730:Percentuale'. The entire sequence container and its children are enclosed in a dashed yellow box labeled 'm730:Giorni_Percentuale_Type'.</p>
namespace	urn:www.agenziaentrate.gov.it:specificheTecniche:sco:730
type	<a href="#">m730:Giorni_Percentuale_Type</a>
children	<a href="#">m730:Giorni</a> <a href="#">m730:Percentuale</a>

complexType **Intervento\_Recupero\_Patrimonio\_Edilizio\_Type**

diagram	<p>The diagram shows a box labeled 'Intervento_Recupero_Patrimoni...' connected to a sequence container (a rounded rectangle with three dots). This sequence container is connected to eight child elements: 'm730:Anno', 'm730:Periodo', 'm730:CodiceFiscale', 'm730:CasellaInterventiParticolari', 'm730:CodiceSituazioniParticolari', 'm730:Rate10', 'm730:Spesa', and 'm730:NOrdineImmobile'. All child elements are enclosed in dashed boxes.</p>
namespace	urn:www.agenziaentrate.gov.it:specificheTecniche:sco:730
children	<a href="#">m730:Anno</a> <a href="#">m730:Periodo</a> <a href="#">m730:CodiceFiscale</a> <a href="#">m730:CasellaInterventiParticolari</a> <a href="#">m730:CodiceSituazioniParticolari</a> <a href="#">m730:Rate10</a> <a href="#">m730:Spesa</a> <a href="#">m730:NOrdineImmobile</a>

element **Intervento\_Recupero\_Patrimonio\_Edilizio\_Type/Anno**

diagram	<p>The diagram shows a box labeled 'm730:Anno' enclosed in a dashed box.</p>																
namespace	urn:www.agenziaentrate.gov.it:specificheTecniche:sco:730																
type	<a href="#">m730:Anno_Recupero_Patrimonio_Edilizio_Type</a>																
facets	<table border="1"> <thead> <tr> <th>Kind</th> <th>Value</th> </tr> </thead> <tbody> <tr> <td>pattern</td> <td>[1-9]{1}[0-9]*</td> </tr> <tr> <td>enumeration</td> <td>2008</td> </tr> <tr> <td>enumeration</td> <td>2009</td> </tr> <tr> <td>enumeration</td> <td>2010</td> </tr> <tr> <td>enumeration</td> <td>2011</td> </tr> <tr> <td>enumeration</td> <td>2012</td> </tr> <tr> <td>enumeration</td> <td>2013</td> </tr> </tbody> </table>	Kind	Value	pattern	[1-9]{1}[0-9]*	enumeration	2008	enumeration	2009	enumeration	2010	enumeration	2011	enumeration	2012	enumeration	2013
Kind	Value																
pattern	[1-9]{1}[0-9]*																
enumeration	2008																
enumeration	2009																
enumeration	2010																
enumeration	2011																
enumeration	2012																
enumeration	2013																

	enumeration	2014
	enumeration	2015
	enumeration	2016
	enumeration	2017

#### element **Intervento\_Ricupero\_Patrimonio\_Edificio\_Type/Periodo**

diagram																									
namespace	urn:www.agenziaentrate.gov.it:specificheTecniche:sco:730																								
type	<a href="#">m730:Periodo Spese Ristrutturazione Type</a>																								
facets	<table border="1"> <thead> <tr> <th>Kind</th> <th>Value</th> </tr> </thead> <tbody> <tr> <td>pattern</td> <td>[1-9]{1}[0-9]*</td> </tr> <tr> <td>enumeration</td> <td>2</td> </tr> <tr> <td>enumeration</td> <td>3</td> </tr> <tr> <td>enumeration</td> <td>4</td> </tr> <tr> <td>enumeration</td> <td>5</td> </tr> <tr> <td>enumeration</td> <td>6</td> </tr> <tr> <td>enumeration</td> <td>7</td> </tr> <tr> <td>enumeration</td> <td>8</td> </tr> <tr> <td>enumeration</td> <td>9</td> </tr> <tr> <td>enumeration</td> <td>10</td> </tr> <tr> <td>enumeration</td> <td>11</td> </tr> </tbody> </table>	Kind	Value	pattern	[1-9]{1}[0-9]*	enumeration	2	enumeration	3	enumeration	4	enumeration	5	enumeration	6	enumeration	7	enumeration	8	enumeration	9	enumeration	10	enumeration	11
Kind	Value																								
pattern	[1-9]{1}[0-9]*																								
enumeration	2																								
enumeration	3																								
enumeration	4																								
enumeration	5																								
enumeration	6																								
enumeration	7																								
enumeration	8																								
enumeration	9																								
enumeration	10																								
enumeration	11																								

#### element **Intervento\_Ricupero\_Patrimonio\_Edificio\_Type/CodiceFiscale**

diagram					
namespace	urn:www.agenziaentrate.gov.it:specificheTecniche:sco:730				
type	<a href="#">DatoCF Type</a>				
facets	<table border="1"> <thead> <tr> <th>Kind</th> <th>Value</th> </tr> </thead> <tbody> <tr> <td>pattern</td> <td>[0-9]{11}[A-Z]{6}[0-9LMNPQRSTUVWXYZ]{2}[A-Z]{1}[0-9LMNPQRSTUVWXYZ]{2}[A-Z]{1}[0-9LMNPQRSTUVWXYZ]{3}[A-Z]{1}</td> </tr> </tbody> </table>	Kind	Value	pattern	[0-9]{11}[A-Z]{6}[0-9LMNPQRSTUVWXYZ]{2}[A-Z]{1}[0-9LMNPQRSTUVWXYZ]{2}[A-Z]{1}[0-9LMNPQRSTUVWXYZ]{3}[A-Z]{1}
Kind	Value				
pattern	[0-9]{11}[A-Z]{6}[0-9LMNPQRSTUVWXYZ]{2}[A-Z]{1}[0-9LMNPQRSTUVWXYZ]{2}[A-Z]{1}[0-9LMNPQRSTUVWXYZ]{3}[A-Z]{1}				

#### element **Intervento\_Ricupero\_Patrimonio\_Edificio\_Type/CasellaInterventiParticolari**

diagram									
namespace	urn:www.agenziaentrate.gov.it:specificheTecniche:sco:730								
type	restriction of <a href="#">DatoN1 Type</a>								
facets	<table border="1"> <thead> <tr> <th>Kind</th> <th>Value</th> </tr> </thead> <tbody> <tr> <td>pattern</td> <td>[1-9]</td> </tr> <tr> <td>enumeration</td> <td>1</td> </tr> <tr> <td>enumeration</td> <td>4</td> </tr> </tbody> </table>	Kind	Value	pattern	[1-9]	enumeration	1	enumeration	4
Kind	Value								
pattern	[1-9]								
enumeration	1								
enumeration	4								

#### element **Intervento\_Ricupero\_Patrimonio\_Edificio\_Type/CodiceSituazioniParticolari**

diagram	
namespace	urn:www.agenziaentrate.gov.it:specificheTecniche:sco:730

type	restriction of <a href="#">DatoN1_Type</a>						
facets	<table> <tr> <td>Kind</td> <td>Value</td> </tr> <tr> <td>pattern</td> <td>[1-9]</td> </tr> <tr> <td>enumeration</td> <td>4</td> </tr> </table>	Kind	Value	pattern	[1-9]	enumeration	4
Kind	Value						
pattern	[1-9]						
enumeration	4						

#### element **Intervento\_Ricupero\_Patrimonio\_Edilizio\_Type/Rate10**

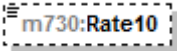
diagram																									
namespace	urn:www.agenziaentrate.gov.it:specificheTecniche:sco:730																								
type	<a href="#">m730:Rate10_Type</a>																								
facets	<table> <tr> <td>Kind</td> <td>Value</td> </tr> <tr> <td>pattern</td> <td>[1-9]{1}[0-9]*</td> </tr> <tr> <td>enumeration</td> <td>1</td> </tr> <tr> <td>enumeration</td> <td>2</td> </tr> <tr> <td>enumeration</td> <td>3</td> </tr> <tr> <td>enumeration</td> <td>4</td> </tr> <tr> <td>enumeration</td> <td>5</td> </tr> <tr> <td>enumeration</td> <td>6</td> </tr> <tr> <td>enumeration</td> <td>7</td> </tr> <tr> <td>enumeration</td> <td>8</td> </tr> <tr> <td>enumeration</td> <td>9</td> </tr> <tr> <td>enumeration</td> <td>10</td> </tr> </table>	Kind	Value	pattern	[1-9]{1}[0-9]*	enumeration	1	enumeration	2	enumeration	3	enumeration	4	enumeration	5	enumeration	6	enumeration	7	enumeration	8	enumeration	9	enumeration	10
Kind	Value																								
pattern	[1-9]{1}[0-9]*																								
enumeration	1																								
enumeration	2																								
enumeration	3																								
enumeration	4																								
enumeration	5																								
enumeration	6																								
enumeration	7																								
enumeration	8																								
enumeration	9																								
enumeration	10																								

#### element **Intervento\_Ricupero\_Patrimonio\_Edilizio\_Type/Spesa**

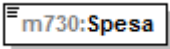
diagram					
namespace	urn:www.agenziaentrate.gov.it:specificheTecniche:sco:730				
type	<a href="#">DatoNP_Type</a>				
facets	<table> <tr> <td>Kind</td> <td>Value</td> </tr> <tr> <td>pattern</td> <td>[1-9]{1}[0-9]*</td> </tr> </table>	Kind	Value	pattern	[1-9]{1}[0-9]*
Kind	Value				
pattern	[1-9]{1}[0-9]*				

#### element **Intervento\_Ricupero\_Patrimonio\_Edilizio\_Type/NOrdineImmobile**

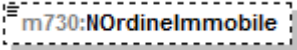
diagram					
namespace	urn:www.agenziaentrate.gov.it:specificheTecniche:sco:730				
type	<a href="#">DatoNP_Type</a>				
facets	<table> <tr> <td>Kind</td> <td>Value</td> </tr> <tr> <td>pattern</td> <td>[1-9]{1}[0-9]*</td> </tr> </table>	Kind	Value	pattern	[1-9]{1}[0-9]*
Kind	Value				
pattern	[1-9]{1}[0-9]*				

complexType **Intervento\_Risparmio\_Energetico\_Type**

diagram	
namespace	urn:www.agenziaentrate.gov.it:specificheTecniche:sco:730
children	<a href="#">m730:TipoIntervento</a> <a href="#">m730:Anno</a> <a href="#">m730:Periodo2013</a> <a href="#">m730:CasiParticolari</a> <a href="#">m730:RideterminazioneRate</a> <a href="#">m730:NumeroRata</a> <a href="#">m730:Spesa</a>

element **Intervento\_Risparmio\_Energetico\_Type/Tipointervento**

diagram																							
namespace	urn:www.agenziaentrate.gov.it:specificheTecniche:sco:730																						
type	<a href="#">m730:Tipo_Intervento_Type</a>																						
facets	<table border="1"> <thead> <tr> <th>Kind</th> <th>Value</th> </tr> </thead> <tbody> <tr> <td>pattern</td> <td>[1-9]</td> </tr> <tr> <td>enumeration</td> <td>1</td> </tr> <tr> <td>enumeration</td> <td>2</td> </tr> <tr> <td>enumeration</td> <td>3</td> </tr> <tr> <td>enumeration</td> <td>4</td> </tr> <tr> <td>enumeration</td> <td>5</td> </tr> <tr> <td>enumeration</td> <td>6</td> </tr> <tr> <td>enumeration</td> <td>7</td> </tr> <tr> <td>enumeration</td> <td>8</td> </tr> <tr> <td>enumeration</td> <td>9</td> </tr> </tbody> </table>	Kind	Value	pattern	[1-9]	enumeration	1	enumeration	2	enumeration	3	enumeration	4	enumeration	5	enumeration	6	enumeration	7	enumeration	8	enumeration	9
Kind	Value																						
pattern	[1-9]																						
enumeration	1																						
enumeration	2																						
enumeration	3																						
enumeration	4																						
enumeration	5																						
enumeration	6																						
enumeration	7																						
enumeration	8																						
enumeration	9																						

element **Intervento\_Risparmio\_Energetico\_Type/Anno**

diagram																	
namespace	urn:www.agenziaentrate.gov.it:specificheTecniche:sco:730																
type	<a href="#">m730:Anno Risparmio Energetico_Type</a>																
facets	<table border="1"> <thead> <tr> <th>Kind</th> <th>Value</th> </tr> </thead> <tbody> <tr> <td>pattern</td> <td>[1-9]{1}[0-9]*</td> </tr> <tr> <td>enumeration</td> <td>2008</td> </tr> <tr> <td>enumeration</td> <td>2011</td> </tr> <tr> <td>enumeration</td> <td>2012</td> </tr> <tr> <td>enumeration</td> <td>2013</td> </tr> <tr> <td>enumeration</td> <td>2014</td> </tr> <tr> <td>enumeration</td> <td>2015</td> </tr> </tbody> </table>	Kind	Value	pattern	[1-9]{1}[0-9]*	enumeration	2008	enumeration	2011	enumeration	2012	enumeration	2013	enumeration	2014	enumeration	2015
Kind	Value																
pattern	[1-9]{1}[0-9]*																
enumeration	2008																
enumeration	2011																
enumeration	2012																
enumeration	2013																
enumeration	2014																
enumeration	2015																

	enumeration	2016
	enumeration	2016
	enumeration	2017

element **Intervento\_Risparmio\_Energetico\_Type/Periodo2013**

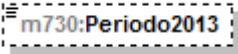
diagram									
namespace	urn:www.agenziaentrate.gov.it:specificheTecniche:sco:730								
type	restriction of <a href="#">DatoN1_Type</a>								
facets	<table border="1"> <thead> <tr> <th>Kind</th> <th>Value</th> </tr> </thead> <tbody> <tr> <td>pattern</td> <td>[1-9]</td> </tr> <tr> <td>enumeration</td> <td>1</td> </tr> <tr> <td>enumeration</td> <td>2</td> </tr> </tbody> </table>	Kind	Value	pattern	[1-9]	enumeration	1	enumeration	2
Kind	Value								
pattern	[1-9]								
enumeration	1								
enumeration	2								

element **Intervento\_Risparmio\_Energetico\_Type/CasiParticolari**

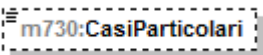
diagram											
namespace	urn:www.agenziaentrate.gov.it:specificheTecniche:sco:730										
type	<a href="#">m730:Casi_Particolari_Risp_Ener_Type</a>										
facets	<table border="1"> <thead> <tr> <th>Kind</th> <th>Value</th> </tr> </thead> <tbody> <tr> <td>pattern</td> <td>[1-9]</td> </tr> <tr> <td>enumeration</td> <td>1</td> </tr> <tr> <td>enumeration</td> <td>2</td> </tr> <tr> <td>enumeration</td> <td>3</td> </tr> </tbody> </table>	Kind	Value	pattern	[1-9]	enumeration	1	enumeration	2	enumeration	3
Kind	Value										
pattern	[1-9]										
enumeration	1										
enumeration	2										
enumeration	3										

element **Intervento\_Risparmio\_Energetico\_Type/RideterminazioneRate**

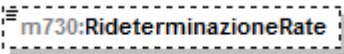
diagram																			
namespace	urn:www.agenziaentrate.gov.it:specificheTecniche:sco:730																		
type	<a href="#">m730:Rate_Risparmio_Energetico_Type</a>																		
facets	<table border="1"> <thead> <tr> <th>Kind</th> <th>Value</th> </tr> </thead> <tbody> <tr> <td>pattern</td> <td>[1-9]{1}[0-9]*</td> </tr> <tr> <td>enumeration</td> <td>4</td> </tr> <tr> <td>enumeration</td> <td>5</td> </tr> <tr> <td>enumeration</td> <td>6</td> </tr> <tr> <td>enumeration</td> <td>7</td> </tr> <tr> <td>enumeration</td> <td>8</td> </tr> <tr> <td>enumeration</td> <td>9</td> </tr> <tr> <td>enumeration</td> <td>10</td> </tr> </tbody> </table>	Kind	Value	pattern	[1-9]{1}[0-9]*	enumeration	4	enumeration	5	enumeration	6	enumeration	7	enumeration	8	enumeration	9	enumeration	10
Kind	Value																		
pattern	[1-9]{1}[0-9]*																		
enumeration	4																		
enumeration	5																		
enumeration	6																		
enumeration	7																		
enumeration	8																		
enumeration	9																		
enumeration	10																		

element **Intervento\_Risparmio\_Energetico\_Type/NumeroRata**

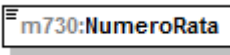
diagram	
namespace	urn:www.agenziaentrate.gov.it:specificheTecniche:sco:730
type	<a href="#">m730:Numero_Rata_Risparmio_Energetico_Type</a>

facets	Kind	Value
	pattern	[1-9]{1}[0-9]*
	enumeration	1
	enumeration	2
	enumeration	3
	enumeration	4
	enumeration	5
	enumeration	6
	enumeration	7
	enumeration	10

#### element **Intervento\_Risparmio\_Energetico\_Type/Spesa**

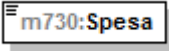
diagram					
namespace	urn:www.agenziaentrate.gov.it:specificheTecniche:sco:730				
type	<a href="#">DatoNP_Type</a>				
facets	<table border="1"> <tr> <td>Kind</td> <td>Value</td> </tr> <tr> <td>pattern</td> <td>[1-9]{1}[0-9]*</td> </tr> </table>	Kind	Value	pattern	[1-9]{1}[0-9]*
Kind	Value				
pattern	[1-9]{1}[0-9]*				

#### complexType **Iva\_Acquisto\_Abitazione\_Type**

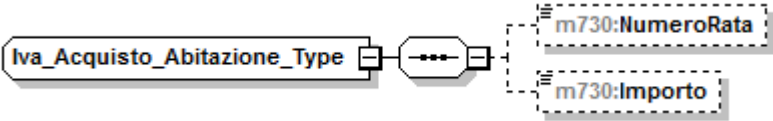
diagram	
namespace	urn:www.agenziaentrate.gov.it:specificheTecniche:sco:730
children	<a href="#">m730:NumeroRata</a> <a href="#">m730:Importo</a>

#### element **Iva\_Acquisto\_Abitazione\_Type/NumeroRata**

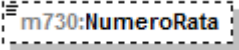
diagram									
namespace	urn:www.agenziaentrate.gov.it:specificheTecniche:sco:730								
type	restriction of <a href="#">DatoNP_Type</a>								
facets	<table border="1"> <tr> <td>Kind</td> <td>Value</td> </tr> <tr> <td>pattern</td> <td>[1-9]{1}[0-9]*</td> </tr> <tr> <td>enumeration</td> <td>1</td> </tr> <tr> <td>enumeration</td> <td>2</td> </tr> </table>	Kind	Value	pattern	[1-9]{1}[0-9]*	enumeration	1	enumeration	2
Kind	Value								
pattern	[1-9]{1}[0-9]*								
enumeration	1								
enumeration	2								

#### element **Iva\_Acquisto\_Abitazione\_Type/Importo**

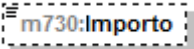
diagram					
namespace	urn:www.agenziaentrate.gov.it:specificheTecniche:sco:730				
type	<a href="#">DatoNP_Type</a>				
facets	<table border="1"> <tr> <td>Kind</td> <td>Value</td> </tr> <tr> <td>pattern</td> <td>[1-9]{1}[0-9]*</td> </tr> </table>	Kind	Value	pattern	[1-9]{1}[0-9]*
Kind	Value				
pattern	[1-9]{1}[0-9]*				

### complexType Lavoro\_Dipendente\_Type

diagram	
namespace	urn:www.agenziaentrate.gov.it:specificheTecniche:sco:730
children	<a href="#">m730:TipologiaReddito</a> <a href="#">m730:TipoContratto</a> <a href="#">m730:Reddito</a>

### element Lavoro\_Dipendente\_Type/TipologiaReddito

diagram																					
namespace	urn:www.agenziaentrate.gov.it:specificheTecniche:sco:730																				
type	restriction of <a href="#">DatoN1_Type</a>																				
facets	<table border="1"> <thead> <tr> <th>Kind</th> <th>Value</th> </tr> </thead> <tbody> <tr> <td>pattern</td> <td>[1-9]</td> </tr> <tr> <td>enumeration</td> <td>1</td> </tr> <tr> <td>enumeration</td> <td>2</td> </tr> <tr> <td>enumeration</td> <td>3</td> </tr> <tr> <td>enumeration</td> <td>4</td> </tr> <tr> <td>enumeration</td> <td>5</td> </tr> <tr> <td>enumeration</td> <td>6</td> </tr> <tr> <td>enumeration</td> <td>7</td> </tr> <tr> <td>enumeration</td> <td>8</td> </tr> </tbody> </table>	Kind	Value	pattern	[1-9]	enumeration	1	enumeration	2	enumeration	3	enumeration	4	enumeration	5	enumeration	6	enumeration	7	enumeration	8
Kind	Value																				
pattern	[1-9]																				
enumeration	1																				
enumeration	2																				
enumeration	3																				
enumeration	4																				
enumeration	5																				
enumeration	6																				
enumeration	7																				
enumeration	8																				

### element Lavoro\_Dipendente\_Type/TipoContratto

diagram									
namespace	urn:www.agenziaentrate.gov.it:specificheTecniche:sco:730								
type	<a href="#">m730:Indeterminato_Determinato_Type</a>								
facets	<table border="1"> <thead> <tr> <th>Kind</th> <th>Value</th> </tr> </thead> <tbody> <tr> <td>pattern</td> <td>[1-9]</td> </tr> <tr> <td>enumeration</td> <td>1</td> </tr> <tr> <td>enumeration</td> <td>2</td> </tr> </tbody> </table>	Kind	Value	pattern	[1-9]	enumeration	1	enumeration	2
Kind	Value								
pattern	[1-9]								
enumeration	1								
enumeration	2								

### element Lavoro\_Dipendente\_Type/Reddito

diagram			
namespace	urn:www.agenziaentrate.gov.it:specificheTecniche:sco:730		
type	<a href="#">DatoNP_Type</a>		
facets	<table border="1"> <thead> <tr> <th>Kind</th> <th>Value</th> </tr> </thead> <tbody> </tbody> </table>	Kind	Value
Kind	Value		

pattern	[1-9]{1}[0-9]*
---------	----------------

### complexType Locazioni\_Brevi\_Type

diagram	
namespace	urn:www.agenziaentrate.gov.it:specificheTecniche:sco:730
children	<a href="#">m730:Ritenute</a>

### element Locazioni\_Brevi\_Type/Ritenute

diagram	
namespace	urn:www.agenziaentrate.gov.it:specificheTecniche:sco:730
type	<a href="#">DatoNP_Type</a>
facets	Kind Value pattern [1-9]{1}[0-9]*

### complexType Misura\_Acconti\_Type

diagram	
namespace	urn:www.agenziaentrate.gov.it:specificheTecniche:sco:730
children	<a href="#">m730:IrpefMisuralInferiore</a> <a href="#">m730:AddComunaleMisuralInferiore</a> <a href="#">m730:CedolareSeccaMisuralInferiore</a> <a href="#">m730:NumeroRate</a>

### element Misura\_Acconti\_Type/IrpefMisuralInferiore

diagram	
namespace	urn:www.agenziaentrate.gov.it:specificheTecniche:sco:730
type	<a href="#">m730:Casella_Acconto_Type</a>
children	<a href="#">m730:Casella</a> <a href="#">m730:ImportoMisuralInferiore</a>



element **Misura\_Aconti\_Type/AddComunaleMisuralInferiore**

diagram	
namespace	urn:www.agenziaentrate.gov.it:specificheTecniche:sco:730
type	<a href="#">m730:Casella_Aconto_Type</a>
children	<a href="#">m730:Casella</a> <a href="#">m730:ImportoMisuralInferiore</a>

element **Misura\_Aconti\_Type/CedolareSeccaMisuralInferiore**

diagram	
namespace	urn:www.agenziaentrate.gov.it:specificheTecniche:sco:730
type	<a href="#">m730:Casella_Aconto_Type</a>
children	<a href="#">m730:Casella</a> <a href="#">m730:ImportoMisuralInferiore</a>

element **Misura\_Aconti\_Type/NumeroRate**

diagram																	
namespace	urn:www.agenziaentrate.gov.it:specificheTecniche:sco:730																
type	restriction of <a href="#">DatoN1_Type</a>																
facets	<table border="1"> <thead> <tr> <th>Kind</th> <th>Value</th> </tr> </thead> <tbody> <tr> <td>pattern</td> <td>[1-9]</td> </tr> <tr> <td>enumeration</td> <td>2</td> </tr> <tr> <td>enumeration</td> <td>3</td> </tr> <tr> <td>enumeration</td> <td>4</td> </tr> <tr> <td>enumeration</td> <td>5</td> </tr> <tr> <td>enumeration</td> <td>6</td> </tr> <tr> <td>enumeration</td> <td>7</td> </tr> </tbody> </table>	Kind	Value	pattern	[1-9]	enumeration	2	enumeration	3	enumeration	4	enumeration	5	enumeration	6	enumeration	7
Kind	Value																
pattern	[1-9]																
enumeration	2																
enumeration	3																
enumeration	4																
enumeration	5																
enumeration	6																
enumeration	7																

complexType **Mod730\_Integrativo\_Type**

diagram	
namespace	urn:www.agenziaentrate.gov.it:specificheTecniche:sco:730
children	<a href="#">m730:ImportiRimborsare</a> <a href="#">m730:ImportoRimborsato</a> <a href="#">m730:ImportoRimborsatoAgenzia</a>

element **Mod730\_Integrativo\_Type/ImportiRimborsare**

diagram	
namespace	urn:www.agenziaentrate.gov.it:specificheTecniche:sco:730
type	<a href="#">m730:Importi Rimborsare 730-4 Integrativo Type</a>
children	<a href="#">m730:IrpefRimborsare</a> <a href="#">m730:AddRegRimborsare</a> <a href="#">m730:AddComRimborsare</a> <a href="#">m730:CedolareRimborsare</a> <a href="#">m730:TassazioneSepRimborsare</a> <a href="#">m730:PremiRisultatoRimborsare</a>

element **Mod730\_Integrativo\_Type/ImportoRimborsato**

diagram					
namespace	urn:www.agenziaentrate.gov.it:specificheTecniche:sco:730				
type	<a href="#">DatoNP_Type</a>				
facets	<table border="1"> <thead> <tr> <th>Kind</th> <th>Value</th> </tr> </thead> <tbody> <tr> <td>pattern</td> <td>[1-9]{1}[0-9]*</td> </tr> </tbody> </table>	Kind	Value	pattern	[1-9]{1}[0-9]*
Kind	Value				
pattern	[1-9]{1}[0-9]*				

element **Mod730\_Integrativo\_Type/ImportoRimborsatoAgenzia**

diagram	
---------	--

namespace	urn:www.agenziaentrate.gov.it:specificheTecniche:sco:730	
type	<a href="#">DatoNP_Type</a>	
facets	Kind	Value
	pattern	[1-9]{1}[0-9]*

### complexType Modulo\_Altri\_Reddi\_Type

diagram		
namespace	urn:www.agenziaentrate.gov.it:specificheTecniche:sco:730	
children	<a href="#">m730:RedditiDiCapitale</a> <a href="#">m730:RedditiTassazioneSeparata</a>	

### element Modulo\_Altri\_Reddi\_Type/RedditiDiCapitale

diagram		
namespace	urn:www.agenziaentrate.gov.it:specificheTecniche:sco:730	
type	<a href="#">m730:Redditi_Capitale_Type</a>	
children	<a href="#">m730:Utili</a> <a href="#">m730:AltriRedditiDiCapitale</a> <a href="#">m730:LavoroAutonomo</a> <a href="#">m730:RedditiDiversi</a> <a href="#">m730:RedditiDiversiDetraz</a>	

### element Modulo\_Altri\_Reddi\_Type/RedditiTassazioneSeparata

diagram		
namespace	urn:www.agenziaentrate.gov.it:specificheTecniche:sco:730	
type	<a href="#">m730:Redditi_Tassazione_Separata_Type</a>	
children	<a href="#">m730:RedditiErede</a> <a href="#">m730:ImposteRimborsate</a>	

complexType **Modulo\_Anotazioni\_Type**

diagram	
namespace	urn:www.agenziaentrate.gov.it:specificheTecniche:sco:730
children	<a href="#">m730:Annotazione</a>

element **Modulo\_Anotazioni\_Type/Annotazione**

diagram	
namespace	urn:www.agenziaentrate.gov.it:specificheTecniche:sco:730
type	<a href="#">m730:Annotazione_Type</a>
children	<a href="#">m730:Codice</a> <a href="#">m730:RigoQuadro</a> <a href="#">m730:ModuloQuadro</a> <a href="#">m730:Importo</a>

complexType **Modulo\_Comunicazione\_Type**

diagram	
namespace	urn:www.agenziaentrate.gov.it:specificheTecniche:sco:730
children	<a href="#">m730:DatiCondominio</a> <a href="#">m730:DatiCatastali</a> <a href="#">m730:DomandaAccatastamento</a> <a href="#">m730:DatiFornitore</a>

element **Modulo\_Communicazione\_Type/DatiCondominio**

diagram	<p>The diagram shows a class <code>m730:DatiCondominio</code> connected to a container <code>m730:Dati_Condominio_Type</code>. The container contains two elements: <code>m730:CodiceFiscale</code> and <code>m730:Denominazione</code>.</p>
namespace	urn:www.agenziaentrate.gov.it:specificheTecniche:sco:730
type	<a href="#">m730:Dati_Condominio_Type</a>
children	<a href="#">m730:CodiceFiscale</a> <a href="#">m730:Denominazione</a>

element **Modulo\_Communicazione\_Type/DatiCatastali**

diagram	<p>The diagram shows a class <code>m730:DatiCatastali</code> connected to a container <code>m730:Dati_Catastali_Type</code>. The container contains six elements: <code>m730:CodiceComune</code>, <code>m730:TerreniUrbano</code>, <code>m730:SezioneUrbanaComuneCa...</code>, <code>m730:Foglio</code>, <code>m730:Particella</code>, and <code>m730:Subalterno</code>.</p>
namespace	urn:www.agenziaentrate.gov.it:specificheTecniche:sco:730
type	<a href="#">m730:Dati_Catastali_Type</a>
children	<a href="#">m730:CodiceComune</a> <a href="#">m730:TerreniUrbano</a> <a href="#">m730:SezioneUrbanaComuneCatastale</a> <a href="#">m730:Foglio</a> <a href="#">m730:Particella</a> <a href="#">m730:Subalterno</a>

element **Modulo\_Communicazione\_Type/DomandaAccatastamento**

diagram	<p>The diagram shows a class <code>m730:DomandaAccatastamento</code> connected to a container <code>m730:Domanda_Accatastamento_Type</code>. The container contains three elements: <code>m730:Data</code>, <code>m730:Numero</code>, and <code>m730:ProvinciaUfficio</code>.</p>
namespace	urn:www.agenziaentrate.gov.it:specificheTecniche:sco:730

type	<a href="#">m730:Domanda Accatastamento Type</a>
children	<a href="#">m730:Data</a> <a href="#">m730:Numero</a> <a href="#">m730:ProvinciaUfficio</a>

element **Modulo\_Communicazione\_Type/DatiFornitore**

diagram	
namespace	urn:www.agenziaentrate.gov.it:specificheTecniche:sco:730
type	<a href="#">m730:Dati_Fornitore_Type</a>
children	<a href="#">m730:CodiceFiscale</a> <a href="#">m730:CognomeDenom</a> <a href="#">m730:Nome</a> <a href="#">m730:Sesso</a> <a href="#">m730:DataNascita</a> <a href="#">m730:ComuneNascita</a> <a href="#">m730:ProvinciaNascita</a> <a href="#">m730:ImportoAcquisti</a> <a href="#">m730:StatoEstero</a>

complexType **Modulo\_Crediti\_Imposta\_Type**

diagram	
namespace	urn:www.agenziaentrate.gov.it:specificheTecniche:sco:730
children	<a href="#">m730:CreditoImpostaFondiPensione</a> <a href="#">m730:CreditoImpostaRedditiEsteri</a> <a href="#">m730:CreditoPrimaCasaSismaAbruzzo</a> <a href="#">m730:CreditoAltriSismaAbruzzo</a> <a href="#">m730:CreditoNegoziazione</a>

element **Modulo\_Crediti\_Imposta\_Type/CreditiImpostaFondiPensione**

diagram	
namespace	urn:www.agenziaentrate.gov.it:specificheTecniche:sco:730
type	<a href="#">m730:Crediti_Imposta_Fondi_Pensione_Type</a>
children	<a href="#">m730:AnnoAnticipazione</a> <a href="#">m730:Reintegro</a> <a href="#">m730:SommaReintegrata</a> <a href="#">m730:CreditoAnno</a>

element **Modulo\_Crediti\_Imposta\_Type/CreditiImpostaRedditiEsteri**

diagram	
namespace	urn:www.agenziaentrate.gov.it:specificheTecniche:sco:730
type	<a href="#">m730:Crediti_Imposta_Redditi_Esteri_Type</a>
children	<a href="#">m730:StatoEstero</a> <a href="#">m730:Anno</a> <a href="#">m730:RedditoEstero</a> <a href="#">m730:ImpostaEstera</a> <a href="#">m730:RedditoComplessivo</a> <a href="#">m730:Imposta_Lorda</a> <a href="#">m730:ImpostaNetta</a> <a href="#">m730:CreditoDichiarazioniPrecedenti</a> <a href="#">m730:DiCuiStatoEstero</a>

element **Modulo\_Crediti\_Imposta\_Type/CreditoPrimaCasaSismaAbruzzo**

diagram	
namespace	urn:www.agenziaentrate.gov.it:specificheTecniche:sco:730
type	<a href="#">m730:Credito_Immobile_Sisma_Abruzzo_Type</a>
children	<a href="#">m730:CodiceFiscale</a> <a href="#">m730:NumeroRata</a> <a href="#">m730:TotaleCredito</a>

element **Modulo\_Crediti\_Imposta\_Type/CreditoAltriSismaAbruzzo**

diagram	
namespace	urn:www.agenziaentrate.gov.it:specificheTecniche:sco:730
type	<a href="#">m730:Crediti_Imposta_Altri_Sisma_Abruzzo_Type</a>
children	<a href="#">m730:Impresa_Professione</a> <a href="#">m730:CreditoImmobileSismaAbruzzo</a> <a href="#">m730:Rateazione</a>

element **Modulo\_Crediti\_Imposta\_Type/CreditoNegoziazione**

diagram	
namespace	urn:www.agenziaentrate.gov.it:specificheTecniche:sco:730
type	<a href="#">m730:Modulo_Credito_Negoziatore_Type</a>
children	<a href="#">m730:CreditoSpettante</a>

complexType **Modulo\_Credito\_Negoziatore\_Type**

diagram	
---------	--



namespace	urn:www.agenziaentrate.gov.it:specificheTecniche:sco:730
children	<a href="#">m730:CreditoSpettante</a>

element **Modulo\_Credito\_Negoziatore\_Type/CreditoSpettante**

diagram					
namespace	urn:www.agenziaentrate.gov.it:specificheTecniche:sco:730				
type	<a href="#">DatoNP_Type</a>				
facets	<table border="1"> <thead> <tr> <th>Kind</th> <th>Value</th> </tr> </thead> <tbody> <tr> <td>pattern</td> <td>[1-9]{1}[0-9]*</td> </tr> </tbody> </table>	Kind	Value	pattern	[1-9]{1}[0-9]*
Kind	Value				
pattern	[1-9]{1}[0-9]*				

complexType **Modulo\_Fabbricato\_Type**

diagram	
namespace	urn:www.agenziaentrate.gov.it:specificheTecniche:sco:730
children	<a href="#">m730:FabbricatoOrd</a> <a href="#">m730:FabbricatoAgev</a>

element **Modulo\_Fabbricato\_Type/FabbricatoOrd**

<p>diagram</p>	
<p>namespace</p>	<p>urn:www.agenziaentrate.gov.it:specificheTecniche:sco:730</p>
<p>type</p>	<p><a href="#">m730:Fabbricato_Ord_Type</a></p>
<p>children</p>	<p><a href="#">m730:Rendita</a> <a href="#">m730:Utilizzo</a> <a href="#">m730:GiorniPossesso</a> <a href="#">m730:PercPossesso</a> <a href="#">m730:CodiceCanone</a> <a href="#">m730:CanoneLocazione</a> <a href="#">m730:CasiParticolari</a> <a href="#">m730:CasellaContinuazione</a> <a href="#">m730:CodiceComune</a> <a href="#">m730:OpzioneCedolare</a> <a href="#">m730:CasellaCasiPartimu</a> <a href="#">m730:StatoEmergenza</a></p>

element **Modulo\_Fabbricato\_Type/FabbricatoAgev**

<p>diagram</p>	
----------------	--

namespace	urn:www.agenziaentrate.gov.it:specificheTecniche:sco:730
type	<a href="#">m730:Fabbricato_Agev_Type</a>
children	<a href="#">m730:NumeroRigoRiferimento</a> <a href="#">m730:NumModuloRiferimento</a> <a href="#">m730:DatiContratto</a> <a href="#">m730:CasellaInf30Giorni</a> <a href="#">m730:AnnoDichiarazioneIcilmu</a>

### complexType **Modulo\_Familiari\_Type**

diagram	
namespace	urn:www.agenziaentrate.gov.it:specificheTecniche:sco:730
children	<a href="#">m730:Coniuge</a> <a href="#">m730:PrimoFiglio</a> <a href="#">m730:Familiari</a>

### element **Modulo\_Familiari\_Type/Coniuge**

diagram	
namespace	urn:www.agenziaentrate.gov.it:specificheTecniche:sco:730
type	<a href="#">m730:Dati_Coniuge_Type</a>
children	<a href="#">m730:Tipo</a> <a href="#">m730:CodiceFiscale</a> <a href="#">m730:Mesi</a>

element **Modulo\_Familiari\_Type/PrimoFiglio**

diagram	<p>The diagram illustrates the structure of the <code>m730:PrimoFiglio</code> element. It is an extension of the <code>m730:Dati_Familiare_Type</code> element. The extension is shown in a yellow dashed box and includes the following elements: <code>m730:CodiceFiscale</code>, <code>m730:Mesi</code>, <code>m730:MesiMinore</code>, <code>m730:PercDetraz</code>, <code>m730:PercDetrazCon</code>, <code>m730:Affidamento</code>, and <code>m730:Tipo</code>. The <code>m730:PrimoFiglio</code> element is shown as a dashed box on the left, connected to the extension box. The <code>m730:Tipo</code> element is shown as a solid box at the bottom, connected to the extension box.</p>
namespace	urn:www.agenziaentrate.gov.it:specificheTecniche:sco:730
type	extension of <a href="#">m730:Dati_Familiare_Type</a>
children	<a href="#">m730:CodiceFiscale</a> <a href="#">m730:Mesi</a> <a href="#">m730:MesiMinore</a> <a href="#">m730:PercDetraz</a> <a href="#">m730:PercDetrazCon</a> <a href="#">m730:Affidamento</a> <a href="#">m730:Tipo</a>

element **Modulo\_Familiari\_Type/PrimoFiglio/Tipo**

diagram	<p>The diagram shows the structure of the <code>m730:Tipo</code> element, which is a restriction of the <code>DatoAN_Type</code> element. The element is shown as a solid box with the text <code>m730:Tipo</code> inside.</p>								
namespace	urn:www.agenziaentrate.gov.it:specificheTecniche:sco:730								
type	restriction of <a href="#">DatoAN_Type</a>								
facets	<table border="0"> <tr> <td>Kind</td> <td>Value</td> </tr> <tr> <td>pattern</td> <td>(([0-9A-Z-])&amp;quot;){1}([ 0-9A-Z&amp;amp;:] ' - \., / ° °\°\( \) À É É Ì Ò Ù Ü &amp;quot;; \\N \\+)*</td> </tr> <tr> <td>enumeration</td> <td>F</td> </tr> <tr> <td>enumeration</td> <td>D</td> </tr> </table>	Kind	Value	pattern	(([0-9A-Z-])&quot;){1}([ 0-9A-Z&amp;:] ' - \., / ° °\°\( \) À É É Ì Ò Ù Ü &quot;; \\N \\+)*	enumeration	F	enumeration	D
Kind	Value								
pattern	(([0-9A-Z-])&quot;){1}([ 0-9A-Z&amp;:] ' - \., / ° °\°\( \) À É É Ì Ò Ù Ü &quot;; \\N \\+)*								
enumeration	F								
enumeration	D								

element **Modulo\_Familiari\_Type/Familiari**

diagram	
namespace	urn:www.agenziaentrate.gov.it:specificheTecniche:sco:730
type	extension of <a href="#">m730:Dati_Familiare_Type</a>
children	<a href="#">m730:CodiceFiscale</a> <a href="#">m730:Mesi</a> <a href="#">m730:MesiMinore</a> <a href="#">m730:PercDetraz</a> <a href="#">m730:PercDetrazCon</a> <a href="#">m730:Affidamento</a> <a href="#">m730:Tipo</a>

element **Modulo\_Familiari\_Type/Familiari/Tipo**

diagram											
namespace	urn:www.agenziaentrate.gov.it:specificheTecniche:sco:730										
type	restriction of <a href="#">DatoAN_Type</a>										
facets	<table border="1"> <thead> <tr> <th>Kind</th> <th>Value</th> </tr> </thead> <tbody> <tr> <td>pattern</td> <td>(([0-9A-Z-])&amp;quot;){1}([ 0-9A-Z&amp;amp;:] ' - \- . \ ' \^\\( \) À È É Ì Ò Ù Û &amp;quot; \\N \\+)*</td> </tr> <tr> <td>enumeration</td> <td>F</td> </tr> <tr> <td>enumeration</td> <td>D</td> </tr> <tr> <td>enumeration</td> <td>A</td> </tr> </tbody> </table>	Kind	Value	pattern	(([0-9A-Z-])&quot;){1}([ 0-9A-Z&amp;:] ' - \- . \ ' \^\\( \) À È É Ì Ò Ù Û &quot; \\N \\+)*	enumeration	F	enumeration	D	enumeration	A
Kind	Value										
pattern	(([0-9A-Z-])&quot;){1}([ 0-9A-Z&amp;:] ' - \- . \ ' \^\\( \) À È É Ì Ò Ù Û &quot; \\N \\+)*										
enumeration	F										
enumeration	D										
enumeration	A										

complexType **Modulo\_Lavoro\_Dip\_Type**

diagram	
---------	--

namespace	urn:www.agenziaentrate.gov.it:specificheTecniche:sco:730
children	<a href="#">m730:LavoroDipendente</a> <a href="#">m730:PremiRisultato</a> <a href="#">m730:AltriRedditiAssLavDip</a> <a href="#">m730:BonusIrpef</a>

element **Modulo\_Lavoro\_Dip\_Type/LavoroDipendente**

diagram	
namespace	urn:www.agenziaentrate.gov.it:specificheTecniche:sco:730
type	<a href="#">m730:Lavoro_Dipendente_Type</a>
children	<a href="#">m730:TipologiaReddito</a> <a href="#">m730:TipoContratto</a> <a href="#">m730:Reddito</a>

element **Modulo\_Lavoro\_Dip\_Type/PremiRisultato**

diagram	
namespace	urn:www.agenziaentrate.gov.it:specificheTecniche:sco:730
type	<a href="#">m730:Premi_Risultato_Modulo_Type</a>
children	<a href="#">m730:TipoLimite</a> <a href="#">m730:ImportoTassazOrdinaria</a> <a href="#">m730:ImportoImpostaSostitutiva</a> <a href="#">m730:RitenuteImpostaSostitutiva</a> <a href="#">m730:Benefit</a> <a href="#">m730:BenefitTassOrdinaria</a>

element **Modulo\_Lavoro\_Dip\_Type/AltriRedditiAssLavDip**

diagram	
namespace	urn:www.agenziaentrate.gov.it:specificheTecniche:sco:730
type	<a href="#">m730:Altri_Redditi_Ass_Lav_Type</a>
children	<a href="#">m730:AssegnoDelConiuge</a> <a href="#">m730:ImportoRedditoAssimilato</a>

element **Modulo\_Lavoro\_Dip\_Type/BonusIrpéf**

diagram	
namespace	urn:www.agenziaentrate.gov.it:specificheTecniche:sco:730
children	<a href="#">m730:Esenzione</a>

element **Modulo\_Lavoro\_Dip\_Type/BonusIrpéf/Esenzione**

diagram	
namespace	urn:www.agenziaentrate.gov.it:specificheTecniche:sco:730
type	<a href="#">m730:Esenzione_Bonus_Type</a>
children	<a href="#">m730:TipologiaEsenzione</a> <a href="#">m730:ParteRedditoEsente</a>

complexType **Modulo\_Oneri\_Type**

<p>diagram</p>	
<p>namespace</p>	<p>urn:www.agenziaentrate.gov.it:specificheTecniche:sco:730</p>
<p>children</p>	<p><a href="#">m730:SpeseDetrazioni</a> <a href="#">m730:SpeseDeduzioni</a> <a href="#">m730:InterventoRecuperoPatrimonioEdilizio</a> <a href="#">m730:DatiCatastaliRecuperoPatrimonioEdilizio</a> <a href="#">m730:InterventoRisparmioEnergetico</a> <a href="#">m730:CanoniLocazione</a> <a href="#">m730:DatiAltreDetrazioni</a> <a href="#">m730:SpeseArredo</a> <a href="#">m730:SpeseArredoGiovani</a> <a href="#">m730:IvaAcquistoAbitazione</a></p>

element **Modulo\_Oneri\_Type/SpeseDetrazioni**

<p>diagram</p>	
<p>namespace</p>	<p>urn:www.agenziaentrate.gov.it:specificheTecniche:sco:730</p>
<p>type</p>	<p><a href="#">m730:Detrazioni Modulo_Type</a></p>



children	<a href="#">m730:VeicoliDisabili</a> <a href="#">m730:AcquistoCaniGuida</a> <a href="#">m730:SpeseRateizzate</a> <a href="#">m730:AltreSpese</a> <a href="#">m730:SpeseLeasing</a>
----------	--

element **Modulo\_Oneri\_Type/SpeseDeduzioni**

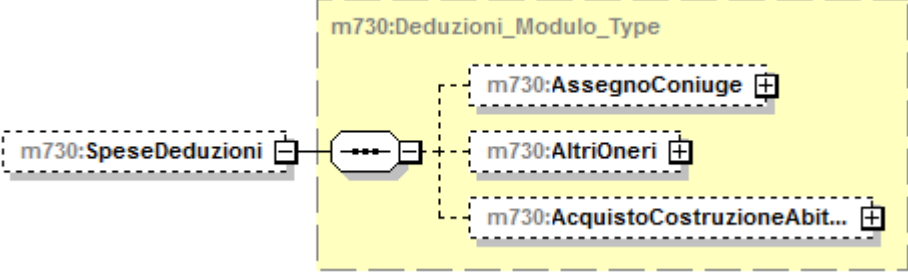
diagram	 <p>The diagram shows a class <code>m730:SpeseDeduzioni</code> on the left, connected to a class <code>m730:Deduzioni_Modulo_Type</code> on the right. The latter is highlighted in yellow and contains three subclasses: <code>m730:AssegnoConiuge</code>, <code>m730:AltriOneri</code>, and <code>m730:AcquistoCostruzioneAbit...</code>. The association between <code>m730:SpeseDeduzioni</code> and <code>m730:Deduzioni_Modulo_Type</code> is shown with a multiplicity of 1 on the <code>m730:SpeseDeduzioni</code> side and a multiplicity of 1 on the <code>m730:Deduzioni_Modulo_Type</code> side.</p>
namespace	urn:www.agenziaentrate.gov.it:specificheTecniche:sco:730
type	<a href="#">m730:Deduzioni Modulo Type</a>
children	<a href="#">m730:AssegnoConiuge</a> <a href="#">m730:AltriOneri</a> <a href="#">m730:AcquistoCostruzioneAbitLocazione</a>

element **Modulo\_Oneri\_Type/InterventoRecuperoPatrimonioEdilizio**

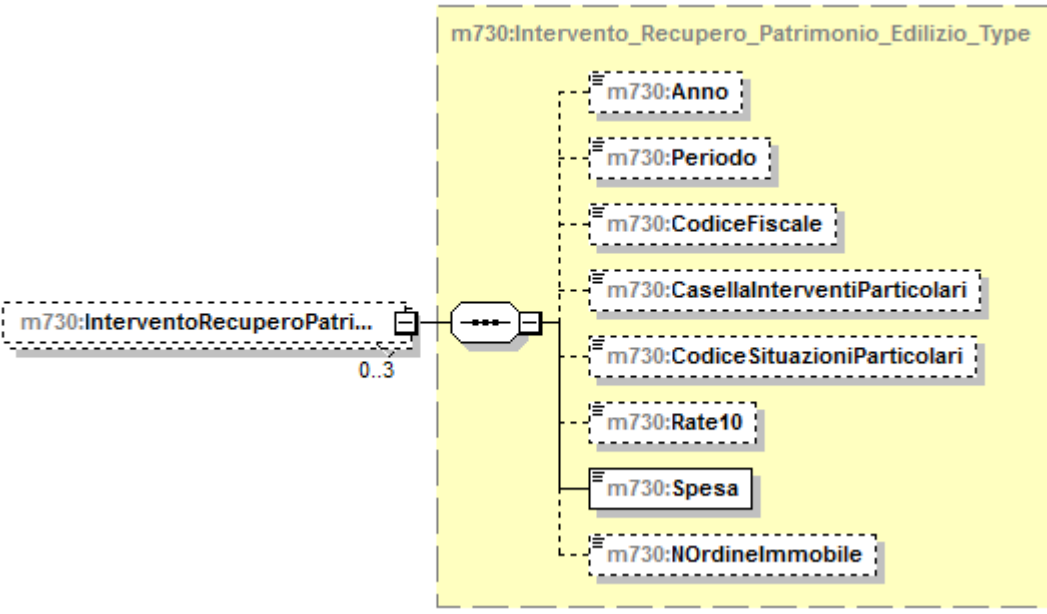
diagram	 <p>The diagram shows a class <code>m730:InterventoRecuperoPatri...</code> on the left, connected to a class <code>m730:Intervento_Ricupero_Patrimonio_Edilizio_Type</code> on the right. The latter is highlighted in yellow and contains eight subclasses: <code>m730:Anno</code>, <code>m730:Periodo</code>, <code>m730:CodiceFiscale</code>, <code>m730:CasellaInterventiParticolari</code>, <code>m730:CodiceSituazioniParticolari</code>, <code>m730:Rate10</code>, <code>m730:Spesa</code>, and <code>m730:NOrdineImmobile</code>. The association between <code>m730:InterventoRecuperoPatri...</code> and <code>m730:Intervento_Ricupero_Patrimonio_Edilizio_Type</code> is shown with a multiplicity of 0..3 on the <code>m730:InterventoRecuperoPatri...</code> side and a multiplicity of 1 on the <code>m730:Intervento_Ricupero_Patrimonio_Edilizio_Type</code> side.</p>
namespace	urn:www.agenziaentrate.gov.it:specificheTecniche:sco:730
type	<a href="#">m730:Intervento Ricupero Patrimonio Edilizio Type</a>
children	<a href="#">m730:Anno</a> <a href="#">m730:Periodo</a> <a href="#">m730:CodiceFiscale</a> <a href="#">m730:CasellaInterventiParticolari</a> <a href="#">m730:CodiceSituazioniParticolari</a> <a href="#">m730:Rate10</a> <a href="#">m730:Spesa</a> <a href="#">m730:NOrdineImmobile</a>

element **Modulo\_Oneri\_Type/DatiCatastaliRecuperoPatrimonioEdilizio**

diagram	
namespace	urn:www.agenziaentrate.gov.it:specificheTecniche:sco:730
type	<a href="#">m730:Sezione Dati Catastali Recupero Patrimonio Edilizio Type</a>
children	<a href="#">m730:DatiCatastaliRecuperoPatrimonioEdilizio</a> <a href="#">m730:DatiRegistrazioneAccatastamentoRecuperoPatrimonio Edilizio</a>

element **Modulo\_Oneri\_Type/InterventoRisparmioEnergetico**

diagram	
namespace	urn:www.agenziaentrate.gov.it:specificheTecniche:sco:730
type	<a href="#">m730:Intervento Risparmio Energetico Type</a>
children	<a href="#">m730:TipoIntervento</a> <a href="#">m730:Anno</a> <a href="#">m730:Periodo2013</a> <a href="#">m730:CasiParticolari</a> <a href="#">m730:RideterminazioneRate</a> <a href="#">m730:NumeroRata</a> <a href="#">m730:Spesa</a>

element **Modulo\_Oneri\_Type/CanoniLocazione**

diagram	
---------	--

namespace	urn:www.agenziaentrate.gov.it:specificheTecniche:sco:730
type	<a href="#">m730:Detrazioni Canoni Locazione Type</a>
children	<a href="#">m730:InquiliniAbitazionePrincipale</a> <a href="#">m730:DipendentiTrasferiti</a>

#### element **Modulo\_Oneri\_Type/DatiAltreDetrazioni**

diagram	
namespace	urn:www.agenziaentrate.gov.it:specificheTecniche:sco:730
type	<a href="#">m730:Dati_Altre_Detrazioni_Modulo_Type</a>
children	<a href="#">m730:AltreDetrazioni</a>

#### element **Modulo\_Oneri\_Type/SpeseArredo**

diagram	
namespace	urn:www.agenziaentrate.gov.it:specificheTecniche:sco:730
type	<a href="#">m730:Spese_Arredo_Type</a>
children	<a href="#">m730:NumeroRata</a> <a href="#">m730:Importo</a>

#### element **Modulo\_Oneri\_Type/SpeseArredoGiovani**

diagram	
namespace	urn:www.agenziaentrate.gov.it:specificheTecniche:sco:730
type	<a href="#">m730:Spese_Arredo_Giovani_Coppie_Type</a>
children	<a href="#">m730:Meno35Anni</a> <a href="#">m730:Importo</a>

element **Modulo\_Oneri\_Type/IvaAcquistoAbitazione**

diagram	
namespace	urn:www.agenziaentrate.gov.it:specificheTecniche:sco:730
type	<a href="#">m730:Iva_Acquisto_Abitazione_Type</a>
children	<a href="#">m730:NumeroRata</a> <a href="#">m730:Importo</a>

complexType **Modulo\_PL\_Type**

diagram	
namespace	urn:www.agenziaentrate.gov.it:specificheTecniche:sco:730
children	<a href="#">m730:CredImpEsteri</a>

element **Modulo\_PL\_Type/CredImpEsteri**

diagram	
namespace	urn:www.agenziaentrate.gov.it:specificheTecniche:sco:730
type	<a href="#">m730:Cred_Imp_Esteri_Type</a>
children	<a href="#">m730:Anno</a> <a href="#">m730:TotCredito</a> <a href="#">m730:CreditoStato</a>

complexType **Modulo\_Terreno\_Type**

diagram	
namespace	urn:www.agenziaentrate.gov.it:specificheTecniche:sco:730
children	<a href="#">m730:Terreno</a>

element **Modulo\_Terreno\_Type/Terreno**

<p>diagram</p>	<pre> classDiagram     class m730_Terreno_Type {         m730_RedDominicale         m730_Titolo         m730_RedAgrario         m730_GiorniPossesso         m730_PercPossesso         m730_CanoneVincolistico         m730_CasiParticolari         m730_CasellaContinuazione         m730_CasellaImmuNonDovuta         m730_CasellaColtivatoreDiretto     }     class m730_Terreno {     }     m730_Terreno "1..6" -- "1" m730_Terreno_Type     </pre>
<p>namespace</p>	<p>urn:www.agenziaentrate.gov.it:specificheTecniche:sco:730</p>
<p>type</p>	<p><a href="#">m730:Terreno_Type</a></p>
<p>children</p>	<p><a href="#">m730:RedDominicale</a> <a href="#">m730:Titolo</a> <a href="#">m730:RedAgrario</a> <a href="#">m730:GiorniPossesso</a> <a href="#">m730:PercPossesso</a>  <a href="#">m730:CanoneVincolistico</a> <a href="#">m730:CasiParticolari</a> <a href="#">m730:CasellaContinuazione</a> <a href="#">m730:CasellaImmuNonDovuta</a>  <a href="#">m730:CasellaColtivatoreDiretto</a></p>

complexType **Oneri\_Non\_Abbattuti\_Type**

diagram	<p>The diagram shows a class <b>Oneri_Non_Abbattuti_Type</b> with a dashed-line container. Inside this container, ten elements are listed, each in a dashed box: <b>m730:DetrazSpeseAssPersonale</b>, <b>m730:DetrazErogazBiennaleVen...</b>, <b>m730:DetrazErogazSpettacolo</b>, <b>m730:DetrazErogazSettoreMus...</b>, <b>m730:DeduzContributiPaesiSvilu...</b>, <b>m730:DeduzOnlus</b>, <b>m730:DetrazOspedaleGalliera</b>, <b>m730:PrevidenzaCompIDipPubbl...</b>, <b>m730:InteressiMutuiAgrari</b>, and <b>m730:DeduzTrust</b>.</p>
namespace	urn:www.agenziaentrate.gov.it:specificheTecniche:sco:730
children	<a href="#">m730:DetrazSpeseAssPersonale</a> <a href="#">m730:DetrazErogazBiennaleVenezia</a> <a href="#">m730:DetrazErogazSpettacolo</a> <a href="#">m730:DetrazErogazSettoreMusicale</a> <a href="#">m730:DeduzContributiPaesiSviluppo</a> <a href="#">m730:DeduzOnlus</a> <a href="#">m730:DetrazOspedaleGalliera</a> <a href="#">m730:PrevidenzaCompIDipPubblici</a> <a href="#">m730:InteressiMutuiAgrari</a> <a href="#">m730:DeduzTrust</a>

element **Oneri\_Non\_Abbattuti\_Type/DetrazSpeseAssPersonale**

diagram	<p>The diagram shows the element <b>m730:DetrazSpeseAssPersonale</b> enclosed in a dashed box.</p>				
namespace	urn:www.agenziaentrate.gov.it:specificheTecniche:sco:730				
type	<a href="#">DatoNP_Type</a>				
facets	<table border="1"> <thead> <tr> <th>Kind</th> <th>Value</th> </tr> </thead> <tbody> <tr> <td>pattern</td> <td>[1-9]{1}[0-9]*</td> </tr> </tbody> </table>	Kind	Value	pattern	[1-9]{1}[0-9]*
Kind	Value				
pattern	[1-9]{1}[0-9]*				

element **Oneri\_Non\_Abbattuti\_Type/DetrazErogazBiennaleVenezia**

diagram	<p>The diagram shows the element <b>m730:DetrazErogazBiennaleVen...</b> enclosed in a dashed box.</p>				
namespace	urn:www.agenziaentrate.gov.it:specificheTecniche:sco:730				
type	<a href="#">DatoNP_Type</a>				
facets	<table border="1"> <thead> <tr> <th>Kind</th> <th>Value</th> </tr> </thead> <tbody> <tr> <td>pattern</td> <td>[1-9]{1}[0-9]*</td> </tr> </tbody> </table>	Kind	Value	pattern	[1-9]{1}[0-9]*
Kind	Value				
pattern	[1-9]{1}[0-9]*				

**element Oneri\_Non\_Abbattuti\_Type/DetrazErogazSpettacolo**

diagram	 m730:DetrazErogazSpettacolo
namespace	urn:www.agenziaentrate.gov.it:specificheTecniche:sco:730
type	<a href="#">DatoNP_Type</a>
facets	Kind Value pattern [1-9]{1}[0-9]*

**element Oneri\_Non\_Abbattuti\_Type/DetrazErogazSettoreMusicale**

diagram	 m730:DetrazErogazSettoreMus...
namespace	urn:www.agenziaentrate.gov.it:specificheTecniche:sco:730
type	<a href="#">DatoNP_Type</a>
facets	Kind Value pattern [1-9]{1}[0-9]*

**element Oneri\_Non\_Abbattuti\_Type/DeduzContributiPaesiSviluppo**

diagram	 m730:DeduzContributiPaesiSvilu...
namespace	urn:www.agenziaentrate.gov.it:specificheTecniche:sco:730
type	<a href="#">DatoNP_Type</a>
facets	Kind Value pattern [1-9]{1}[0-9]*

**element Oneri\_Non\_Abbattuti\_Type/DeduzOnlus**

diagram	 m730:DeduzOnlus
namespace	urn:www.agenziaentrate.gov.it:specificheTecniche:sco:730
type	<a href="#">DatoNP_Type</a>
facets	Kind Value pattern [1-9]{1}[0-9]*

**element Oneri\_Non\_Abbattuti\_Type/DetrazOspedaleGalliera**

diagram	 m730:DetrazOspedaleGalliera
namespace	urn:www.agenziaentrate.gov.it:specificheTecniche:sco:730
type	<a href="#">DatoNP_Type</a>
facets	Kind Value pattern [1-9]{1}[0-9]*

element **Oneri\_Non\_Abbattuti\_Type/PrevidenzaCompIDipPubblici**

diagram					
namespace	urn:www.agenziaentrate.gov.it:specificheTecniche:sco:730				
type	<a href="#">DatoNP_Type</a>				
facets	<table border="1"> <tr> <td>Kind</td> <td>Value</td> </tr> <tr> <td>pattern</td> <td>[1-9]{1}[0-9]*</td> </tr> </table>	Kind	Value	pattern	[1-9]{1}[0-9]*
Kind	Value				
pattern	[1-9]{1}[0-9]*				

element **Oneri\_Non\_Abbattuti\_Type/InteressiMutuiAgrari**

diagram					
namespace	urn:www.agenziaentrate.gov.it:specificheTecniche:sco:730				
type	<a href="#">DatoNP_Type</a>				
facets	<table border="1"> <tr> <td>Kind</td> <td>Value</td> </tr> <tr> <td>pattern</td> <td>[1-9]{1}[0-9]*</td> </tr> </table>	Kind	Value	pattern	[1-9]{1}[0-9]*
Kind	Value				
pattern	[1-9]{1}[0-9]*				

element **Oneri\_Non\_Abbattuti\_Type/DeduzTrust**

diagram					
namespace	urn:www.agenziaentrate.gov.it:specificheTecniche:sco:730				
type	<a href="#">DatoNP_Type</a>				
facets	<table border="1"> <tr> <td>Kind</td> <td>Value</td> </tr> <tr> <td>pattern</td> <td>[1-9]{1}[0-9]*</td> </tr> </table>	Kind	Value	pattern	[1-9]{1}[0-9]*
Kind	Value				
pattern	[1-9]{1}[0-9]*				

complexType **Oneri\_Type**

diagram	
namespace	urn:www.agenziaentrate.gov.it:specificheTecniche:sco:730
children	<a href="#">m730:PrimoModulo</a> <a href="#">m730:Modulo</a>



element **Oneri\_Type/PrimoModulo**

<p>diagram</p>	
<p>namespace</p>	<p>urn:www.agenziaentrate.gov.it:specificheTecniche:sco:730</p>
<p>type</p>	<p><a href="#">m730:Primo_Modulo_Oneri_Type</a></p>
<p>children</p>	<p><a href="#">m730:SpeseDetrazioni</a> <a href="#">m730:SpeseDeduzioni</a> <a href="#">m730:InterventoRecuperoPatrimonioEdilizio</a> <a href="#">m730:DatiCatastaliRecuperoPatrimonioEdilizio</a> <a href="#">m730:InterventoRisparmioEnergetico</a> <a href="#">m730:CanoniLocazione</a> <a href="#">m730:DatiAltreDetrazioni</a> <a href="#">m730:OneriNonAbbattuti</a> <a href="#">m730:SpeseArredo</a> <a href="#">m730:SpeseArredoGiovani</a> <a href="#">m730:IvaAcquistoAbitazione</a></p>

element **Oneri\_Type/Modulo**

<p>diagram</p>	
<p>namespace</p>	<p>urn:www.agenziaentrate.gov.it:specificheTecniche:sco:730</p>
<p>type</p>	<p><a href="#">m730:Modulo_Oneri_Type</a></p>
<p>children</p>	<p><a href="#">m730:SpeseDetrazioni</a> <a href="#">m730:SpeseDeduzioni</a> <a href="#">m730:InterventoRecuperoPatrimonioEdilizio</a> <a href="#">m730:DatiCatastaliRecuperoPatrimonioEdilizio</a> <a href="#">m730:InterventoRisparmioEnergetico</a> <a href="#">m730:CanoniLocazione</a> <a href="#">m730:DatiAltreDetrazioni</a> <a href="#">m730:SpeseArredo</a> <a href="#">m730:SpeseArredoGiovani</a> <a href="#">m730:IvaAcquistoAbitazione</a></p>

complexType **Opzione\_Produttivita\_Type**

<p>diagram</p>	
<p>namespace</p>	<p>urn:www.agenziaentrate.gov.it:specificheTecniche:sco:730</p>

complexType **Periodo\_Di\_Lavoro\_Type**

<p>diagram</p>	
<p>namespace</p>	<p>urn:www.agenziaentrate.gov.it:specificheTecniche:sco:730</p>

children	<a href="#">m730:GiorniLavoroDipendente</a> <a href="#">m730:GiorniPensione</a>
----------	---

element **Periodo\_Di\_Lavoro\_Type/GiorniLavoroDipendente**

diagram					
namespace	urn:www.agenziaentrate.gov.it:specificheTecniche:sco:730				
type	<a href="#">DatoGA_Type</a>				
facets	<table border="1"> <thead> <tr> <th>Kind</th> <th>Value</th> </tr> </thead> <tbody> <tr> <td>pattern</td> <td>[1-9]((1-9)[0-9])((12)[0-9][0-9])(3[0-5][0-9])(36[0-5])</td> </tr> </tbody> </table>	Kind	Value	pattern	[1-9]((1-9)[0-9])((12)[0-9][0-9])(3[0-5][0-9])(36[0-5])
Kind	Value				
pattern	[1-9]((1-9)[0-9])((12)[0-9][0-9])(3[0-5][0-9])(36[0-5])				

element **Periodo\_Di\_Lavoro\_Type/GiorniPensione**

diagram					
namespace	urn:www.agenziaentrate.gov.it:specificheTecniche:sco:730				
type	<a href="#">DatoGA_Type</a>				
facets	<table border="1"> <thead> <tr> <th>Kind</th> <th>Value</th> </tr> </thead> <tbody> <tr> <td>pattern</td> <td>[1-9]((1-9)[0-9])((12)[0-9][0-9])(3[0-5][0-9])(36[0-5])</td> </tr> </tbody> </table>	Kind	Value	pattern	[1-9]((1-9)[0-9])((12)[0-9][0-9])(3[0-5][0-9])(36[0-5])
Kind	Value				
pattern	[1-9]((1-9)[0-9])((12)[0-9][0-9])(3[0-5][0-9])(36[0-5])				

complexType **Pignoramento\_Type**

diagram	
namespace	urn:www.agenziaentrate.gov.it:specificheTecniche:sco:730
children	<a href="#">m730:TipoRedditoPignoramento</a> <a href="#">m730:RitenutePignoramento</a>

element **Pignoramento\_Type/TipoRedditoPignoramento**

diagram																	
namespace	urn:www.agenziaentrate.gov.it:specificheTecniche:sco:730																
type	restriction of <a href="#">DatoN1_Type</a>																
facets	<table border="1"> <thead> <tr> <th>Kind</th> <th>Value</th> </tr> </thead> <tbody> <tr> <td>pattern</td> <td>[1-9]</td> </tr> <tr> <td>enumeration</td> <td>1</td> </tr> <tr> <td>enumeration</td> <td>2</td> </tr> <tr> <td>enumeration</td> <td>3</td> </tr> <tr> <td>enumeration</td> <td>4</td> </tr> <tr> <td>enumeration</td> <td>5</td> </tr> <tr> <td>enumeration</td> <td>6</td> </tr> </tbody> </table>	Kind	Value	pattern	[1-9]	enumeration	1	enumeration	2	enumeration	3	enumeration	4	enumeration	5	enumeration	6
Kind	Value																
pattern	[1-9]																
enumeration	1																
enumeration	2																
enumeration	3																
enumeration	4																
enumeration	5																
enumeration	6																

element **Pignoramento\_Type/RitenutePignoramento**

diagram	
namespace	urn:www.agenziaentrategov.it:specificheTecniche:sco:730
type	<a href="#">DatoNP_Type</a>
facets	Kind Value pattern [1-9]{1}[0-9]*

complexType **Premi\_Risultato\_Modulo\_Type**

diagram	
namespace	urn:www.agenziaentrategov.it:specificheTecniche:sco:730
children	<a href="#">m730:TipoLimite</a> <a href="#">m730:ImportoTassazOrdinaria</a> <a href="#">m730:ImportoImpostaSostitutiva</a> <a href="#">m730:RitenuteImpostaSostitutiva</a> <a href="#">m730:Benefit</a> <a href="#">m730:BenefitTassOrdinaria</a>

element **Premi\_Risultato\_Modulo\_Type/TipoLimite**

diagram	
namespace	urn:www.agenziaentrategov.it:specificheTecniche:sco:730
type	restriction of <a href="#">DatoN1_Type</a>
facets	Kind Value pattern [1-9] enumeration 1 enumeration 2

element **Premi\_Risultato\_Modulo\_Type/ImportoTassazOrdinaria**

diagram	
namespace	urn:www.agenziaentrategov.it:specificheTecniche:sco:730
type	<a href="#">DatoNP_Type</a>
facets	Kind Value pattern [1-9]{1}[0-9]*

element **Premi\_Risultato\_Modulo\_Type/ImportoImpostaSostitutiva**

diagram	 m730:ImportoImpostaSostitutiva
namespace	urn:www.agenziaentrate.gov.it:specificheTecniche:sco:730
type	<a href="#">DatoNP_Type</a>
facets	Kind Value pattern [1-9]{1}[0-9]*

element **Premi\_Risultato\_Modulo\_Type/RitenuteImpostaSostitutiva**

diagram	 m730:RitenuteImpostaSostitutiva
namespace	urn:www.agenziaentrate.gov.it:specificheTecniche:sco:730
type	<a href="#">DatoNP_Type</a>
facets	Kind Value pattern [1-9]{1}[0-9]*

element **Premi\_Risultato\_Modulo\_Type/Benefit**

diagram	 m730:Benefit
namespace	urn:www.agenziaentrate.gov.it:specificheTecniche:sco:730
type	<a href="#">DatoNP_Type</a>
facets	Kind Value pattern [1-9]{1}[0-9]*

element **Premi\_Risultato\_Modulo\_Type/BenefitTassOrdinaria**

diagram	 m730:BenefitTassOrdinaria
namespace	urn:www.agenziaentrate.gov.it:specificheTecniche:sco:730
type	<a href="#">DatoNP_Type</a>
facets	Kind Value pattern [1-9]{1}[0-9]*

complexType **Premi\_Risultato\_Type**

diagram	
namespace	urn:www.agenziaentrate.gov.it:specificheTecniche:sco:730
type	extension of <a href="#">m730:Premi_Risultato_Modulo_Type</a>
children	<a href="#">m730:TipoLimite</a> <a href="#">m730:ImportoTassazOrdinaria</a> <a href="#">m730:ImportoImpostaSostitutiva</a> <a href="#">m730:RitenuteImpostaSostitutiva</a> <a href="#">m730:Benefit</a> <a href="#">m730:BenefitTassOrdinaria</a> <a href="#">m730:TassazOrdinaria</a> <a href="#">m730:TassazSostitutiva</a> <a href="#">m730:AssenzaRequisiti</a>

element **Premi\_Risultato\_Type/TassazOrdinaria**

diagram	
namespace	urn:www.agenziaentrate.gov.it:specificheTecniche:sco:730
type	<a href="#">DatoCB_Type</a>
facets	Kind Value pattern [01]

element **Premi\_Risultato\_Type/TassazSostitutiva**

diagram	
namespace	urn:www.agenziaentrate.gov.it:specificheTecniche:sco:730
type	<a href="#">DatoCB_Type</a>
facets	Kind Value pattern [01]

element **Premi\_Risultato\_Type/AssenzaRequisiti**

diagram	
namespace	urn:www.agenziaentrate.gov.it:specificheTecniche:sco:730
type	<a href="#">DatoCB_Type</a>
facets	Kind Value pattern [01]

complexType **Primo\_Modulo\_Acconti\_Ritenute\_Type**

diagram	
namespace	urn:www.agenziaentrate.gov.it:specificheTecniche:sco:730
children	<a href="#">m730:Accontilrpef</a> <a href="#">m730:AltreRitenute</a> <a href="#">m730:Eccedenze</a> <a href="#">m730:EccedenzeOltreAnno</a> <a href="#">m730:RitenuteAccontiSospesi</a> <a href="#">m730:MisuraAcconti</a> <a href="#">m730:EsenzioneAddComunale</a> <a href="#">m730:Dati730Integrativo</a> <a href="#">m730:AccontiAltriDati</a> <a href="#">m730:LocazioniBrevi</a>

element **Primo\_Modulo\_Acconti\_Ritenute\_Type/Accontilrpef**

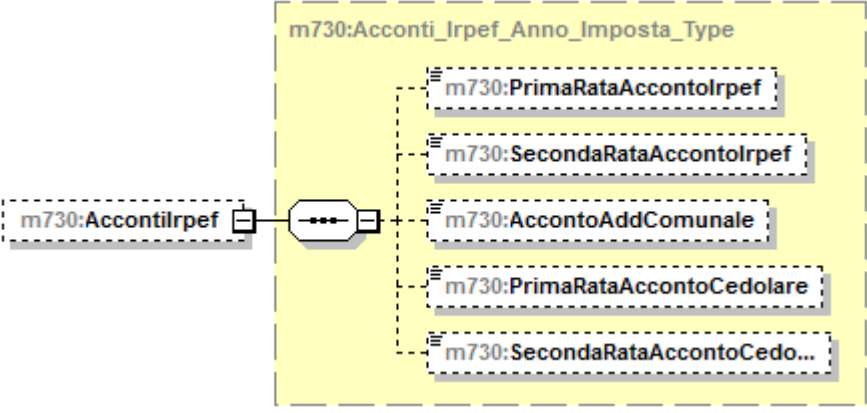
diagram	
namespace	urn:www.agenziaentrate.gov.it:specificheTecniche:sco:730
type	<a href="#">m730:Acconti_Irpef_Anno_Imposta_Type</a>
children	<a href="#">m730:PrimaRataAccontolrpef</a> <a href="#">m730:SecondaRataAccontolrpef</a> <a href="#">m730:AccontoAddComunale</a> <a href="#">m730:PrimaRataAccontoCedolare</a> <a href="#">m730:SecondaRataAccontoCedolare</a>

element **Primo\_Modulo\_Acconti\_Ritenute\_Type/AltreRitenute**

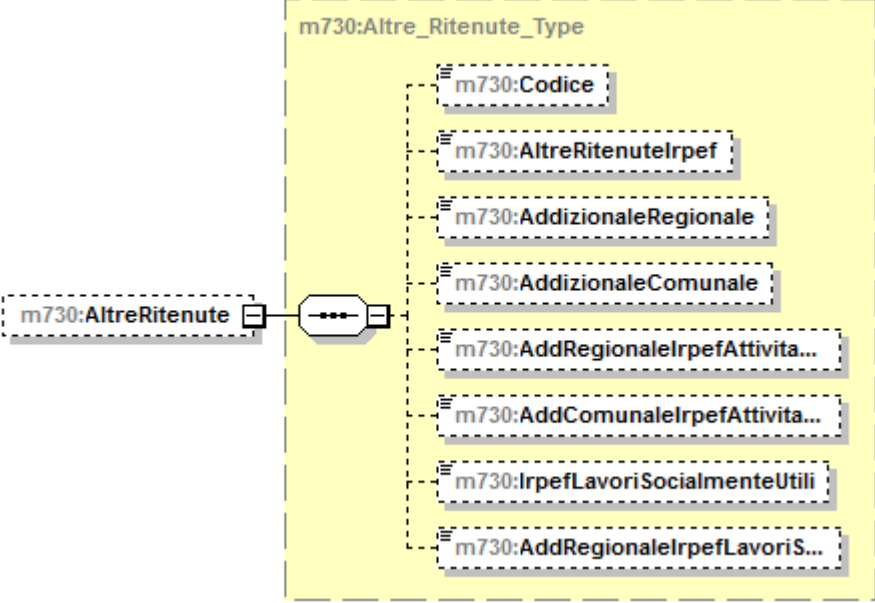
diagram	
namespace	urn:www.agenziaentrate.gov.it:specificheTecniche:sco:730
type	<a href="#">m730:Altre_Ritenute_Type</a>
children	<a href="#">m730:Codice</a> <a href="#">m730:AltreRitenuteIrpef</a> <a href="#">m730:AddizionaleRegionale</a> <a href="#">m730:AddizionaleComunale</a> <a href="#">m730:AddRegionaleIrpefAttivitaSport</a> <a href="#">m730:AddComunaleIrpefAttivitaSport</a> <a href="#">m730:IrpefLavoriSocialmenteUtili</a> <a href="#">m730:AddRegionaleIrpefLavoriSoc Utili</a>



element **Primo\_Modulo\_Acconti\_Ritenute\_Type/Eccedenze**

<p>diagram</p>	
<p>namespace</p>	<p>urn:www.agenziaentrate.gov.it:specificheTecniche:sco:730</p>
<p>type</p>	<p><a href="#">m730:Eccedenze_Type</a></p>
<p>children</p>	<p><a href="#">m730:Irpef</a> <a href="#">m730:IrpefCompF24</a> <a href="#">m730:SostitutivaQuadroRT</a> <a href="#">m730:SostitutivaQuadroRTcompF24</a>  <a href="#">m730:CedolareSecca</a> <a href="#">m730:CedolareSeccaCompF24</a> <a href="#">m730:CodiceRegione</a> <a href="#">m730:AddRegionaleIrpef</a>  <a href="#">m730:AddRegionaleIrpefCompF24</a> <a href="#">m730:CodiceCatastaleComune</a> <a href="#">m730:AddComunaleIrpef</a>  <a href="#">m730:AddComunaleIrpefF24</a> <a href="#">m730:PremioRisultato</a> <a href="#">m730:PremioRisultatoCompF24</a></p>

element **Primo\_Modulo\_Acconti\_Ritenute\_Type/EccedenzeOltreAnno**

diagram	
namespace	urn:www.agenziaentrare.gov.it:specificheTecniche:sco:730
type	<a href="#">m730:Eccedenze Oltre Anno Type</a>
children	<a href="#">m730:Anno</a> <a href="#">m730:Irpef</a> <a href="#">m730:SostitutivaQuadroRT</a> <a href="#">m730:CedolareSecca</a> <a href="#">m730:CodiceRegione</a> <a href="#">m730:AddRegionaleIrpef</a> <a href="#">m730:CodiceCatastaleComune</a> <a href="#">m730:AddComunaleIrpef</a> <a href="#">m730:ImpostaSostitutiva</a>

element **Primo\_Modulo\_Acconti\_Ritenute\_Type/RitenuteAccontiSospesi**

diagram	
namespace	urn:www.agenziaentrare.gov.it:specificheTecniche:sco:730
type	<a href="#">m730:Ritenute Acconti Sospesi Type</a>
children	<a href="#">m730:CodiceEvento</a> <a href="#">m730:Irpef</a> <a href="#">m730:AddRegionaleIrpef</a> <a href="#">m730:AddComunaleIrpef</a> <a href="#">m730:SostitutivaPremi</a> <a href="#">m730:CedolareSecca</a>

element **Primo\_Modulo\_Acconti\_Ritenute\_Type/MisuraAcconti**

diagram	
namespace	urn:www.agenziaentrate.gov.it:specificheTecniche:sco:730
type	<a href="#">m730:Misura_Acconti_Type</a>
children	<a href="#">m730:IrpefMisuralInferiore</a> <a href="#">m730:AddComunaleMisuralInferiore</a> <a href="#">m730:CedolareSeccaMisuralInferiore</a> <a href="#">m730:NumeroRate</a>

element **Primo\_Modulo\_Acconti\_Ritenute\_Type/EsenzioneAddComunale**

diagram	
namespace	urn:www.agenziaentrate.gov.it:specificheTecniche:sco:730
type	<a href="#">m730:Esenzione_Add_Comunale_Type</a>
children	<a href="#">m730:SogliaEsenzioneSaldo</a> <a href="#">m730:SogliaEsenzioneAcconto</a>

element **Primo\_Modulo\_Acconti\_Ritenute\_Type/Dati730Integrativo**

diagram	
namespace	urn:www.agenziaentrate.gov.it:specificheTecniche:sco:730
type	<a href="#">m730:Dati_730_Integrativo_Type</a>
children	<a href="#">m730:Rimborso</a> <a href="#">m730:Credito</a>

element **Primo\_Modulo\_Acconti\_Ritenute\_Type/AccontiAltriDati**

diagram	<p>The diagram shows a class <code>m730:AccontiAltriDati</code> (dashed border) which is a composition (solid line with a filled square) of a class <code>m730:Acconti_Altri_Dati_Type</code> (yellow background, dashed border). The <code>m730:Acconti_Altri_Dati_Type</code> class is further composed of five other classes: <code>m730:IncapientiDetrazioneFigli</code>, <code>m730:IncapientiDetrazioneLocaz...</code>, <code>m730:RestituzioneBonusFiscale</code>, <code>m730:RestituzioneBonusStraord...</code>, and <code>m730:Pignoramento</code>. All these sub-classes are shown with dashed borders, indicating they are abstract or interface classes.</p>
namespace	urn:www.agenziaentrate.gov.it:specificheTecniche:sco:730
type	<a href="#">m730:Acconti_Altri_Dati_Type</a>
children	<a href="#">m730:IncapientiDetrazioneFigli</a> <a href="#">m730:IncapientiDetrazioneLocazione</a> <a href="#">m730:RestituzioneBonusFiscale</a> <a href="#">m730:RestituzioneBonusStraordinario</a> <a href="#">m730:Pignoramento</a>

element **Primo\_Modulo\_Acconti\_Ritenute\_Type/LocazioniBrevi**

diagram	<p>The diagram shows a class <code>m730:LocazioniBrevi</code> (dashed border) which is a composition (solid line with a filled square) of a class <code>m730:Locazioni_Brevi_Type</code> (yellow background, dashed border). The <code>m730:Locazioni_Brevi_Type</code> class is further composed of a class <code>m730:Ritenute</code> (dashed border).</p>
namespace	urn:www.agenziaentrate.gov.it:specificheTecniche:sco:730
type	<a href="#">m730:Locazioni_Brevi_Type</a>
children	<a href="#">m730:Ritenute</a>

complexType **Primo\_Modulo\_Crediti\_Imposta\_Type**

<p>diagram</p>	
<p>namespace</p>	<p>urn:www.agenziaentrate.gov.it:specificheTecniche:sco:730</p>
<p>children</p>	<p><a href="#">m730:CreditoImpostaFabbri...</a> <a href="#">m730:CreditoImpostaFondiPens...</a> <a href="#">m730:CreditoImpostaRedditiEsteri</a> <a href="#">m730:CreditoPrimaCasaSismaAbruzzo</a> <a href="#">m730:CreditoAltriSismaAbruzzo</a> <a href="#">m730:CreditoIncrementoOccupazione</a> <a href="#">m730:CreditoImpostaMediazioni</a> <a href="#">m730:CreditoErogazioniCultura</a> <a href="#">m730:CreditoNegoziazione</a> <a href="#">m730:CreditoErogazioniScuola</a> <a href="#">m730:CreditoVideosorveglianza</a></p>

element **Primo\_Modulo\_Crediti\_Imposta\_Type/CreditoImpostaFabbri...**

<p>diagram</p>	
<p>namespace</p>	<p>urn:www.agenziaentrate.gov.it:specificheTecniche:sco:730</p>
<p>type</p>	<p><a href="#">m730:Credito Imposta Fabbriati Type</a></p>
<p>children</p>	<p><a href="#">m730:ResiduoFabbriati</a> <a href="#">m730:CanoniLocazioneNonPercepti</a></p>

element **Primo\_Modulo\_Crediti\_Imposta\_Type/CreditImpostaFondiPensione**

diagram	
namespace	urn:www.agenziaentrate.gov.it:specificheTecniche:sco:730
type	extension of <a href="#">m730:Crediti_Imposta_Fondi_Pensione_Type</a>
children	<a href="#">m730:AnnoAnticipazione</a> <a href="#">m730:Reintegro</a> <a href="#">m730:SommaReintegrata</a> <a href="#">m730:CreditoAnno</a> <a href="#">m730:ResiduoPrecedenteDichiarazione</a> <a href="#">m730:DiCuiCompensatoF24</a>

element

**Primo\_Modulo\_Crediti\_Imposta\_Type/CreditImpostaFondiPensione/ResiduoPrecedenteDichiarazione**

diagram					
namespace	urn:www.agenziaentrate.gov.it:specificheTecniche:sco:730				
type	<a href="#">DatoNP_Type</a>				
facets	<table border="1"> <thead> <tr> <th>Kind</th> <th>Value</th> </tr> </thead> <tbody> <tr> <td>pattern</td> <td>[1-9]{1}[0-9]*</td> </tr> </tbody> </table>	Kind	Value	pattern	[1-9]{1}[0-9]*
Kind	Value				
pattern	[1-9]{1}[0-9]*				

element **Primo\_Modulo\_Crediti\_Imposta\_Type/CreditImpostaFondiPensione/DiCuiCompensatoF24**

diagram					
namespace	urn:www.agenziaentrate.gov.it:specificheTecniche:sco:730				
type	<a href="#">DatoNP_Type</a>				
facets	<table border="1"> <thead> <tr> <th>Kind</th> <th>Value</th> </tr> </thead> <tbody> <tr> <td>pattern</td> <td>[1-9]{1}[0-9]*</td> </tr> </tbody> </table>	Kind	Value	pattern	[1-9]{1}[0-9]*
Kind	Value				
pattern	[1-9]{1}[0-9]*				

element **Primo\_Modulo\_Crediti\_Imposta\_Type/CreditiImpostaRedditiEsteri**

diagram	
namespace	urn:www.agenziaentrate.gov.it:specificheTecniche:sco:730
type	<a href="#">m730:Crediti_Imposta_Redditi_Esteri_Type</a>
children	<a href="#">m730:StatoEstero</a> <a href="#">m730:Anno</a> <a href="#">m730:RedditoEstero</a> <a href="#">m730:ImpostaEstera</a> <a href="#">m730:RedditoComplessivo</a> <a href="#">m730:Imposta_Lorda</a> <a href="#">m730:ImpostaNetta</a> <a href="#">m730:CreditoDichiarazioniPrecedenti</a> <a href="#">m730:DiCuiStatoEstero</a>

element **Primo\_Modulo\_Crediti\_Imposta\_Type/CreditoPrimaCasaSismaAbruzzo**

diagram	
namespace	urn:www.agenziaentrate.gov.it:specificheTecniche:sco:730
type	extension of <a href="#">m730:Credito_Immobilabile_Sisma_Abruzzo_Type</a>
children	<a href="#">m730:CodiceFiscale</a> <a href="#">m730:NumeroRata</a> <a href="#">m730:TotaleCredito</a> <a href="#">m730:ResiduoPrecedenteDichiarazione</a>

element **Primo\_Modulo\_Crediti\_Imposta\_Type/CreditoPrimaCasaSismaAbruzzo/ResiduoPrecedenteDichiarazio**

ne

diagram	
namespace	urn:www.agenziaentrate.gov.it:specificheTecniche:sco:730
type	<a href="#">DatoNP_Type</a>
facets	Kind Value pattern [1-9]{1}[0-9]*

element **Primo Modulo Crediti Imposta Type/CreditoAltriSismaAbruzzo**

diagram	
namespace	urn:www.agenziaentrate.gov.it:specificheTecniche:sco:730
type	<a href="#">m730:Crediti Imposta Altri Sisma Abruzzo Type</a>
children	<a href="#">m730:Impresa Professione</a> <a href="#">m730:CreditoImmobileSismaAbruzzo</a> <a href="#">m730:Rateazione</a>

element **Primo Modulo Crediti Imposta Type/CreditoIncrementoOccupazione**

diagram	
namespace	urn:www.agenziaentrate.gov.it:specificheTecniche:sco:730
type	<a href="#">m730:Credito Incremento Occupazione Type</a>
children	<a href="#">m730:ResiduoPrecedenteDichiarazione</a> <a href="#">m730:DiCuiCompensatoF24</a>

element **Primo Modulo Crediti Imposta Type/CreditoImpostaMediazioni**

diagram	
---------	--



namespace	urn:www.agenziaentrate.gov.it:specificheTecniche:sco:730
type	<a href="#">m730:Residuo_Credito_Compens_AnnoImposta_Type</a>
children	<a href="#">m730:CreditoAnno</a> <a href="#">m730:DiCuiCompensatoF24</a>

element **Primo\_Modulo\_Crediti\_Imposta\_Type/CreditoErogazioniCultura**

diagram	
namespace	urn:www.agenziaentrate.gov.it:specificheTecniche:sco:730
type	<a href="#">m730:Credito_Erogazioni_Cultura_Type</a>
children	<a href="#">m730:SpesaAnno</a> <a href="#">m730:ResiduoAnnoPrec</a> <a href="#">m730:RataAnnoPrec</a> <a href="#">m730:RataDueAnniPrec</a>

element **Primo\_Modulo\_Crediti\_Imposta\_Type/CreditoNegoziazione**

diagram	
namespace	urn:www.agenziaentrate.gov.it:specificheTecniche:sco:730
type	<a href="#">m730:Credito_Negoziatore_Type</a>
children	<a href="#">m730:CreditoSpettante</a> <a href="#">m730:ResiduoAnnoPrec</a> <a href="#">m730:DiCuiCompensatoF24</a>

element **Primo\_Modulo\_Crediti\_Imposta\_Type/CreditoErogazioniScuola**

diagram	
namespace	urn:www.agenziaentrate.gov.it:specificheTecniche:sco:730
type	<a href="#">m730:Credito_Erogazioni_Scuola_Type</a>
children	<a href="#">m730:SpesaAnno</a> <a href="#">m730:SpesaAnnoPrec</a> <a href="#">m730:ResiduoAnnoPrec</a>

element **Primo\_Modulo\_Crediti\_Imposta\_Type/CreditoVideosorveglianza**

diagram	
namespace	urn:www.agenziaentrate.gov.it:specificheTecniche:sco:730
type	<a href="#">m730:Credito_Videosorveglianza_Type</a>
children	<a href="#">m730:ResiduoAnnoPrec</a> <a href="#">m730:DiCuiCompensatoF24</a>

complexType **Primo\_Modulo\_Familiari\_Type**

diagram	
namespace	urn:www.agenziaentrate.gov.it:specificheTecniche:sco:730
type	extension of <a href="#">m730:Modulo_Familiari_Type</a>

children	<a href="#">m730:Coniuge</a> <a href="#">m730:PrimoFiglio</a> <a href="#">m730:Familiari</a> <a href="#">m730:PercUlteriore</a> <a href="#">m730:FigliAffidoPread</a>
----------	---

#### element **Primo\_Modulo\_Familiari\_Type/PercUlteriore**

diagram					
namespace	urn:www.agenziaentrate.gov.it:specificheTecniche:sco:730				
type	<a href="#">DatoPC_Type</a>				
facets	<table border="1"> <tr> <td>Kind</td> <td>Value</td> </tr> <tr> <td>pattern</td> <td>[0-9]?[0-9](, d{1,3})? 100,(0{1,3})?</td> </tr> </table>	Kind	Value	pattern	[0-9]?[0-9](, d{1,3})? 100,(0{1,3})?
Kind	Value				
pattern	[0-9]?[0-9](, d{1,3})? 100,(0{1,3})?				

#### element **Primo\_Modulo\_Familiari\_Type/FigliAffidoPread**

diagram					
namespace	urn:www.agenziaentrate.gov.it:specificheTecniche:sco:730				
type	<a href="#">DatoNP_Type</a>				
facets	<table border="1"> <tr> <td>Kind</td> <td>Value</td> </tr> <tr> <td>pattern</td> <td>[1-9]{1}[0-9]*</td> </tr> </table>	Kind	Value	pattern	[1-9]{1}[0-9]*
Kind	Value				
pattern	[1-9]{1}[0-9]*				

#### complexType **Primo\_Modulo\_Lavoro\_Dip\_Type**

diagram	
namespace	urn:www.agenziaentrate.gov.it:specificheTecniche:sco:730
children	<a href="#">m730:LavoroDipendente</a> <a href="#">m730:PremiRisultato</a> <a href="#">m730:PeriodoLavoro</a> <a href="#">m730:AltriRedditiAssLavDip</a> <a href="#">m730:RitenuteLavoroDipendente</a> <a href="#">m730:Bonuslrpef</a> <a href="#">m730:CasellaCasiParticolari</a>

element **Primo Modulo Lavoro Dip Type/LavoroDipendente**

diagram	
namespace	urn:www.agenziaentrate.gov.it:specificheTecniche:sco:730
type	<a href="#">m730:Lavoro Dipendente Type</a>
children	<a href="#">m730:TipologiaReddito</a> <a href="#">m730:TipoContratto</a> <a href="#">m730:Reddito</a>

element **Primo Modulo Lavoro Dip Type/PremiRisultato**

diagram	
namespace	urn:www.agenziaentrate.gov.it:specificheTecniche:sco:730
type	<a href="#">m730:Premi Risultato Type</a>
children	<a href="#">m730:TipoLimite</a> <a href="#">m730:ImportoTassazOrdinaria</a> <a href="#">m730:ImportoImpostaSostitutiva</a> <a href="#">m730:RitenuteImpostaSostitutiva</a> <a href="#">m730:Benefit</a> <a href="#">m730:BenefitTassOrdinaria</a> <a href="#">m730:TassazOrdinaria</a> <a href="#">m730:TassazSostitutiva</a> <a href="#">m730:AssenzaRequisiti</a>

element **Primo\_Modulo\_Lavoro\_Dip\_Type/PeriodoLavoro**

diagram	<p>The diagram shows a dashed box labeled 'm730:PeriodoLavoro' connected to a solid box labeled 'm730:Periodo_Di_Lavoro_Type'. Inside the solid box, there are two dashed boxes: 'm730:GiorniLavoroDipendente' and 'm730:GiorniPensione'.</p>
namespace	urn:www.agenziaentrate.gov.it:specificheTecniche:sco:730
type	<a href="#">m730:Periodo Di Lavoro Type</a>
children	<a href="#">m730:GiorniLavoroDipendente</a> <a href="#">m730:GiorniPensione</a>

element **Primo\_Modulo\_Lavoro\_Dip\_Type/AltriRedditiAssLavDip**

diagram	<p>The diagram shows a dashed box labeled 'm730:AltriRedditiAssLavDip' connected to a solid box labeled 'm730:Altri_Redditi_Ass_Lav_Type'. The connection has a cardinality of '0..3'. Inside the solid box, there are two dashed boxes: 'm730:AssegnoDelConiuge' and 'm730:ImportoRedditoAssimilato'.</p>
namespace	urn:www.agenziaentrate.gov.it:specificheTecniche:sco:730
type	<a href="#">m730:Altri Redditi Ass Lav Type</a>
children	<a href="#">m730:AssegnoDelConiuge</a> <a href="#">m730:ImportoRedditoAssimilato</a>

element **Primo\_Modulo\_Lavoro\_Dip\_Type/RitenuteLavoroDipendente**

diagram	<p>The diagram shows a dashed box labeled 'm730:RitenuteLavoroDipendente' connected to a solid box labeled 'm730:Ritenute_Lavoro_Dip_Type'. Inside the solid box, there are five dashed boxes: 'm730:Ritlrpef', 'm730:RitAddRegionale', 'm730:RitAccAddComunale', 'm730:RitSaldoAddComunale', and 'm730:RitAccAddComAnnoPres'.</p>
namespace	urn:www.agenziaentrate.gov.it:specificheTecniche:sco:730
type	<a href="#">m730:Ritenute Lavoro Dip Type</a>
children	<a href="#">m730:Ritlrpef</a> <a href="#">m730:RitAddRegionale</a> <a href="#">m730:RitAccAddComunale</a> <a href="#">m730:RitSaldoAddComunale</a> <a href="#">m730:RitAccAddComAnnoPres</a>

element **Primo\_Modulo\_Lavoro\_Dip\_Type/BonusIrpef**

diagram	
namespace	urn:www.agenziaentrate.gov.it:specificheTecniche:sco:730
type	<a href="#">m730:Bonus_Irpef_Type</a>
children	<a href="#">m730:CodiceBonus</a> <a href="#">m730:BonusErogato</a> <a href="#">m730:Esenzione</a> <a href="#">m730:QuotaTfr</a>

element **Primo\_Modulo\_Lavoro\_Dip\_Type/CasellaCasiParticolari**

diagram													
namespace	urn:www.agenziaentrate.gov.it:specificheTecniche:sco:730												
type	restriction of <a href="#">DatoN1_Type</a>												
facets	<table border="1"> <thead> <tr> <th>Kind</th> <th>Value</th> </tr> </thead> <tbody> <tr> <td>pattern</td> <td>[1-9]</td> </tr> <tr> <td>enumeration</td> <td>1</td> </tr> <tr> <td>enumeration</td> <td>2</td> </tr> <tr> <td>enumeration</td> <td>4</td> </tr> <tr> <td>enumeration</td> <td>5</td> </tr> </tbody> </table>	Kind	Value	pattern	[1-9]	enumeration	1	enumeration	2	enumeration	4	enumeration	5
Kind	Value												
pattern	[1-9]												
enumeration	1												
enumeration	2												
enumeration	4												
enumeration	5												

complexType **Primo\_Modulo\_Oneri\_Type**

<p>diagram</p>	
<p>namespace</p>	<p>urn:www.agenziaentrate.gov.it:specificheTecniche:sco:730</p>
<p>children</p>	<p><a href="#">m730:SpeseDetrazioni</a> <a href="#">m730:SpeseDeduzioni</a> <a href="#">m730:InterventoRecuperoPatrimonioEdilizio</a> <a href="#">m730:DatiCatastaliRecuperoPatrimonioEdilizio</a> <a href="#">m730:InterventoRisparmioEnergetico</a> <a href="#">m730:CanoniLocazione</a> <a href="#">m730:DatiAltreDetrazioni</a> <a href="#">m730:OneriNonAbbattuti</a> <a href="#">m730:SpeseArredo</a> <a href="#">m730:SpeseArredoGiovani</a> <a href="#">m730:IvaAcquistoAbitazione</a></p>

element **Primo\_Modulo\_Oneri\_Type/SpeseDetrazioni**

<p>diagram</p>	<p>The diagram illustrates the structure of the <b>m730:SpeseDetrazioni</b> element. It is composed of a <b>m730:Detrazioni_Type</b> container and several sub-elements. The sub-elements are:</p> <ul style="list-style-type: none"> <li>m730:CasellaRateazione</li> <li>m730:SpeseDeterminatePatologie</li> <li>m730:Spese Sanitarie</li> <li>m730:SpeseFamNonACarico</li> <li>m730:Spese SanitarieDisabili</li> <li>m730:VeicoliDisabili (+)</li> <li>m730:AcquistoCaniGuida (+)</li> <li>m730:SpeseRateizzate (+)</li> <li>m730:MutuiAbPrincipale</li> <li>m730:Altre Spese (+)</li> <li>m730:SpeseLeasing (+)</li> </ul> <p>The <b>m730:Altre Spese</b> element has a cardinality of 0..3. The <b>m730:SpeseDetrazioni</b> element is connected to the <b>m730:Detrazioni_Type</b> container via a composition relationship.</p>
<p>namespace</p>	<p>urn:www.agenziaentrate.gov.it:specificheTecniche:sco:730</p>
<p>type</p>	<p><a href="#">m730:Detrazioni_Type</a></p>
<p>children</p>	<p><a href="#">m730:CasellaRateazione</a> <a href="#">m730:SpeseDeterminatePatologie</a> <a href="#">m730:SpeseSanitarie</a> <a href="#">m730:SpeseFamNonACarico</a> <a href="#">m730:SpeseSanitarieDisabili</a> <a href="#">m730:VeicoliDisabili</a> <a href="#">m730:AcquistoCaniGuida</a> <a href="#">m730:SpeseRateizzate</a> <a href="#">m730:MutuiAbPrincipale</a> <a href="#">m730:AltreSpese</a> <a href="#">m730:SpeseLeasing</a></p>



element **Primo\_Modulo\_Oneri\_Type/SpeseDeduzioni**

<p>diagram</p>	
<p>namespace</p>	<p>urn:www.agenziaentrate.gov.it:specificheTecniche:sco:730</p>
<p>type</p>	<p><a href="#">m730:Deduzioni_Type</a></p>
<p>children</p>	<p><a href="#">m730:ContributiPrevAss</a> <a href="#">m730:AssegnoConiuge</a> <a href="#">m730:ContributiColf</a> <a href="#">m730:ErogazionilstituzioniReligiose</a> <a href="#">m730:SpesePortatoriHandicap</a> <a href="#">m730:AltriOneri</a> <a href="#">m730:DeducibilitaOrdinaria</a> <a href="#">m730:LavoratoriPrimaOccupazione</a> <a href="#">m730:FondiInSquilibrioFinanziario</a> <a href="#">m730:FamiliariACarico</a> <a href="#">m730:FondoPensioneDipendentiPubblici</a> <a href="#">m730:AcquistoCostruzioneAbitLocazione</a> <a href="#">m730:RestituzioneSomme</a></p>

element **Primo\_Modulo\_Oneri\_Type/InterventoRecuperoPatrimonioEdilizio**

<p>diagram</p>	
<p>namespace</p>	<p>urn:www.agenziaentrate.gov.it:specificheTecniche:sco:730</p>
<p>type</p>	<p><a href="#">m730:Intervento Recupero Patrimonio Edilizio Type</a></p>
<p>children</p>	<p><a href="#">m730:Anno</a> <a href="#">m730:Periodo</a> <a href="#">m730:CodiceFiscale</a> <a href="#">m730:CasellaInterventiParticolari</a> <a href="#">m730:CodiceSituazioniParticolari</a> <a href="#">m730:Rate10</a> <a href="#">m730:Spesa</a> <a href="#">m730:NOrdineImmobile</a></p>

element **Primo\_Modulo\_Oneri\_Type/DatiCatastaliRecuperoPatrimonioEdilizio**

<p>diagram</p>	
<p>namespace</p>	<p>urn:www.agenziaentrate.gov.it:specificheTecniche:sco:730</p>
<p>type</p>	<p><a href="#">m730:Sezione Dati Catastali Recupero Patrimonio Edilizio Type</a></p>
<p>children</p>	<p><a href="#">m730:DatiCatastaliRecuperoPatrimonioEdilizio</a>  <a href="#">m730:DatiRegistrazioneAccatastamentoRecuperoPatrimonio Edilizio</a></p>

element **Primo\_Modulo\_Oneri\_Type/InterventoRisparmioEnergético**

diagram	
namespace	urn:www.agenziaentrate.gov.it:specificheTecniche:sco:730
type	<a href="#">m730:Intervento_Risparmio_Energetico_Type</a>
children	<a href="#">m730:TipoIntervento</a> <a href="#">m730:Anno</a> <a href="#">m730:Periodo2013</a> <a href="#">m730:CasiParticolari</a> <a href="#">m730:RideterminazioneRate</a> <a href="#">m730:NumeroRata</a> <a href="#">m730:Spesa</a>

element **Primo\_Modulo\_Oneri\_Type/CanoniLocazione**

diagram	
namespace	urn:www.agenziaentrate.gov.it:specificheTecniche:sco:730
type	<a href="#">m730:Detrazioni_Canoni_Locazione_Type</a>
children	<a href="#">m730:InquiliniAbitazionePrincipale</a> <a href="#">m730:DipendentiTrasferiti</a>

element **Primo\_Modulo\_Oneri\_Type/DatiAltreDetrazioni**

diagram	
---------	--

namespace	urn:www.agenziaentrate.gov.it:specificheTecniche:sco:730
type	<a href="#">m730:Dati_Altre_Detrazioni_Type</a>
children	<a href="#">m730:SpeseCaniGuida</a> <a href="#">m730:AffittoTerreniAgricoliGiovani</a> <a href="#">m730:AltreDetrazioni</a>

element **Primo\_Modulo\_Oneri\_Type/OneriNonAbbattuti**

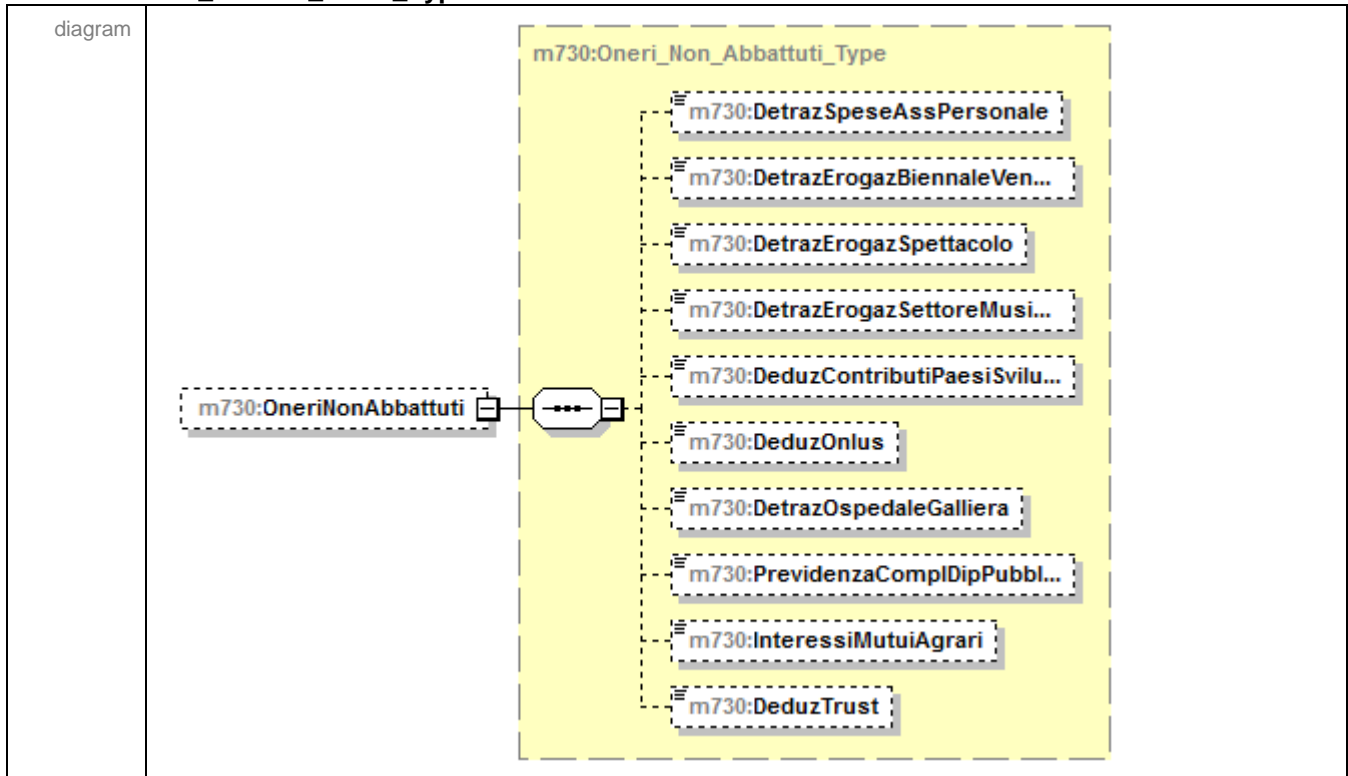

namespace	urn:www.agenziaentrate.gov.it:specificheTecniche:sco:730
type	<a href="#">m730:Oneri_Non_Abbattuti_Type</a>
children	<a href="#">m730:DetrazSpeseAssPersonale</a> <a href="#">m730:DetrazErogazBiennaleVenezia</a> <a href="#">m730:DetrazErogazSpettacolo</a> <a href="#">m730:DetrazErogazSettoreMusicale</a> <a href="#">m730:DeduzContributiPaesiSviluppo</a> <a href="#">m730:DeduzOnlus</a> <a href="#">m730:DetrazOspedaleGalliera</a> <a href="#">m730:PrevidenzaCompIDipPubblici</a> <a href="#">m730:InteressiMutuiAgrari</a> <a href="#">m730:DeduzTrust</a>

element **Primo\_Modulo\_Oneri\_Type/SpeseArredo**

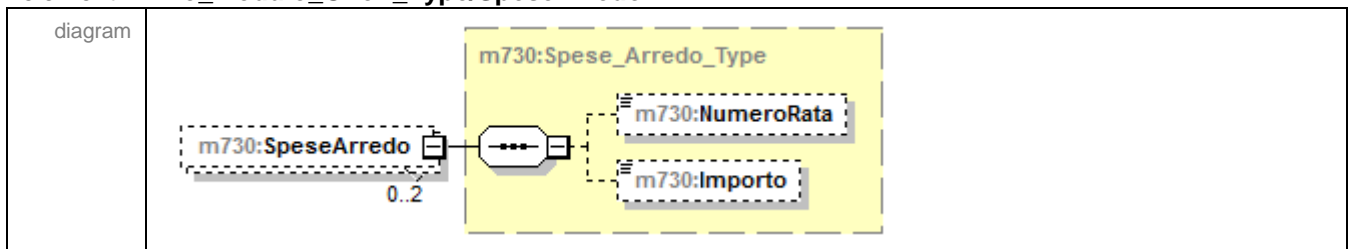

namespace	urn:www.agenziaentrate.gov.it:specificheTecniche:sco:730
type	<a href="#">m730:Spese_Arredo_Type</a>

children	<a href="#">m730:NumeroRata</a> <a href="#">m730:Importo</a>
----------	--

element **Primo\_Modulo\_Oneri\_Type/SpeseArredoGiovani**

diagram	
namespace	urn:www.agenziaentrate.gov.it:specificheTecniche:sco:730
type	<a href="#">m730:Spese_Arredo_Giovani_Coppie_Type</a>
children	<a href="#">m730:Meno35Anni</a> <a href="#">m730:Importo</a>

element **Primo\_Modulo\_Oneri\_Type/IvaAcquistoAbitazione**

diagram	
namespace	urn:www.agenziaentrate.gov.it:specificheTecniche:sco:730
type	<a href="#">m730:Iva_Acquisto_Abitazione_Type</a>
children	<a href="#">m730:NumeroRata</a> <a href="#">m730:Importo</a>

complexType **Primo\_Modulo\_PL\_Type**

diagram	
namespace	urn:www.agenziaentrate.gov.it:specificheTecniche:sco:730
children	<a href="#">m730:Prospetto</a> <a href="#">m730:ProspettoRideterminato</a>

element **Primo\_Modulo\_PL\_Type/Prospetto**

<p>diagram</p>	<p>The diagram illustrates the structure of the <code>m730:Prospetto</code> element. It is an extension of the <code>m730:Prospetto_Type</code> base type. The extension is shown in a yellow dashed box and includes the following elements:</p> <ul style="list-style-type: none"> <li><code>m730:RiepilogoRedditi</code></li> <li><code>m730:ImpostaLorda</code></li> <li><code>m730:DetrazioniCrediti</code></li> <li><code>m730:ImpostaNetta</code></li> <li><code>m730:Addizionali</code></li> <li><code>m730:CedolareSecca</code></li> <li><code>m730:LiquidazioneImposte</code></li> <li><code>m730:AltriDati</code></li> <li><code>m730:CredImpEestero</code></li> <li><code>m730:DatiCreditiF24</code></li> </ul>
<p>namespace</p>	<p>urn:www.agenziaentrate.gov.it:specificheTecniche:sco:730</p>
<p>type</p>	<p>extension of <a href="#">m730:Prospetto_Type</a></p>
<p>children</p>	<p><a href="#">m730:RiepilogoRedditi</a> <a href="#">m730:ImpostaLorda</a> <a href="#">m730:DetrazioniCrediti</a> <a href="#">m730:ImpostaNetta</a> <a href="#">m730:Addizionali</a> <a href="#">m730:CedolareSecca</a> <a href="#">m730:LiquidazioneImposte</a> <a href="#">m730:AltriDati</a> <a href="#">m730:CredImpEestero</a> <a href="#">m730:DatiCreditiF24</a></p>

element **Primo\_Modulo\_PL\_Type/Prospetto/Addizionali**

<p>diagram</p>	
<p>namespace</p>	<p>urn:www.agenziaentrate.gov.it:specificheTecniche:sco:730</p>
<p>type</p>	<p><a href="#">m730:Addizionali_Type</a></p>
<p>children</p>	<p><a href="#">m730:Imponibile</a> <a href="#">m730:AddRegDovuta</a> <a href="#">m730:AddRegCertif</a> <a href="#">m730:EccedenzaAddReg</a> <a href="#">m730:AddComDovuta</a> <a href="#">m730:AddComCertif</a> <a href="#">m730:EccedenzaAddCom</a> <a href="#">m730:AccontoAddCom</a> <a href="#">m730:AccontoAddComCertif</a></p>

element **Primo\_Modulo\_PL\_Type/Prospetto/CedolareSecca**

<p>diagram</p>	
<p>namespace</p>	<p>urn:www.agenziaentrate.gov.it:specificheTecniche:sco:730</p>
<p>type</p>	<p><a href="#">m730:Cedolare_Secca_Type</a></p>
<p>children</p>	<p><a href="#">m730:CedolareDovuta</a> <a href="#">m730:CedolareDifferenza</a> <a href="#">m730:EccedenzaCedolareSecca</a> <a href="#">m730:AccontoCedolare</a></p>

element **Primo\_Modulo\_PL\_Type/Prospetto/LiquidazioneImposte**

<p>diagram</p>	
<p>namespace</p>	<p>urn:www.agenziaentrate.gov.it:specificheTecniche:sco:730</p>
<p>children</p>	<p><a href="#">m730:EsitoIrpef</a> <a href="#">m730:EsitoAddRegionale</a> <a href="#">m730:EsitoAddComunale</a> <a href="#">m730:PrimaRataAcclrpef</a>  <a href="#">m730:SecondaRataAcclrpef</a> <a href="#">m730:AccontoTassSep</a> <a href="#">m730:AccontoAddComunale</a> <a href="#">m730:ImpostaSostitutiva</a>  <a href="#">m730:EsitoCedolare Secca</a> <a href="#">m730:PrimaRataAccCedolare</a> <a href="#">m730:SecondaRataAccCedolare</a></p>

element **Primo\_Modulo\_PL\_Type/Prospetto/LiquidazioneImposte/EsitoIrpef**

<p>diagram</p>	
<p>namespace</p>	<p>urn:www.agenziaentrate.gov.it:specificheTecniche:sco:730</p>
<p>type</p>	<p><a href="#">m730:Esito Liquidazione Type</a></p>
<p>children</p>	<p><a href="#">m730:Credito</a> <a href="#">m730:Debito</a></p>



element **Primo\_Modulo\_PL\_Type/Prospetto/LiquidazioneImposte/EsitoAddRegionale**

diagram	
namespace	urn:www.agenziaentrate.gov.it:specificheTecniche:sco:730
type	extension of <a href="#">m730:Esito_Liquidazione_Type</a>
children	<a href="#">m730:Credito</a> <a href="#">m730:Debito</a> <a href="#">m730:CodAddReg</a>

element **Primo\_Modulo\_PL\_Type/Prospetto/LiquidazioneImposte/EsitoAddRegionale/CodAddReg**

diagram																																															
namespace	urn:www.agenziaentrate.gov.it:specificheTecniche:sco:730																																														
type	<a href="#">Codice Regione Type</a>																																														
facets	<table border="1"> <thead> <tr> <th>Kind</th> <th>Value</th> </tr> </thead> <tbody> <tr> <td>pattern</td> <td>([0-9A-Z-] &amp;quot;){1}([ 0-9A-Z&amp;amp;] ' \- \- . \ ° \^ \( \) À È É ì ò ù Û &amp;quot; \N \+)*</td> </tr> <tr><td>enumeration</td><td>1</td></tr> <tr><td>enumeration</td><td>2</td></tr> <tr><td>enumeration</td><td>3</td></tr> <tr><td>enumeration</td><td>4</td></tr> <tr><td>enumeration</td><td>5</td></tr> <tr><td>enumeration</td><td>6</td></tr> <tr><td>enumeration</td><td>7</td></tr> <tr><td>enumeration</td><td>8</td></tr> <tr><td>enumeration</td><td>9</td></tr> <tr><td>enumeration</td><td>10</td></tr> <tr><td>enumeration</td><td>11</td></tr> <tr><td>enumeration</td><td>12</td></tr> <tr><td>enumeration</td><td>13</td></tr> <tr><td>enumeration</td><td>14</td></tr> <tr><td>enumeration</td><td>15</td></tr> <tr><td>enumeration</td><td>16</td></tr> <tr><td>enumeration</td><td>17</td></tr> <tr><td>enumeration</td><td>18</td></tr> <tr><td>enumeration</td><td>19</td></tr> <tr><td>enumeration</td><td>20</td></tr> <tr><td>enumeration</td><td>21</td></tr> </tbody> </table>	Kind	Value	pattern	([0-9A-Z-] &quot;){1}([ 0-9A-Z&amp;] ' \- \- . \ ° \^ \( \) À È É ì ò ù Û &quot; \N \+)*	enumeration	1	enumeration	2	enumeration	3	enumeration	4	enumeration	5	enumeration	6	enumeration	7	enumeration	8	enumeration	9	enumeration	10	enumeration	11	enumeration	12	enumeration	13	enumeration	14	enumeration	15	enumeration	16	enumeration	17	enumeration	18	enumeration	19	enumeration	20	enumeration	21
Kind	Value																																														
pattern	([0-9A-Z-] &quot;){1}([ 0-9A-Z&amp;] ' \- \- . \ ° \^ \( \) À È É ì ò ù Û &quot; \N \+)*																																														
enumeration	1																																														
enumeration	2																																														
enumeration	3																																														
enumeration	4																																														
enumeration	5																																														
enumeration	6																																														
enumeration	7																																														
enumeration	8																																														
enumeration	9																																														
enumeration	10																																														
enumeration	11																																														
enumeration	12																																														
enumeration	13																																														
enumeration	14																																														
enumeration	15																																														
enumeration	16																																														
enumeration	17																																														
enumeration	18																																														
enumeration	19																																														
enumeration	20																																														
enumeration	21																																														

element **Primo\_Modulo\_PL\_Type/Prospetto/LiquidazioneImposte/EsitoAddComunale**

diagram	
namespace	urn:www.agenziaentrate.gov.it:specificheTecniche:sco:730
type	extension of <a href="#">m730:Esito_Liquidazione_Type</a>
children	<a href="#">m730:Credito</a> <a href="#">m730:Debito</a> <a href="#">m730:CodiceAddCom</a>

element **Primo\_Modulo\_PL\_Type/Prospetto/LiquidazioneImposte/EsitoAddComunale/CodiceAddCom**

diagram					
namespace	urn:www.agenziaentrate.gov.it:specificheTecniche:sco:730				
type	<a href="#">DatoAN_Type</a>				
facets	<table border="1"> <thead> <tr> <th>Kind</th> <th>Value</th> </tr> </thead> <tbody> <tr> <td>pattern</td> <td>([0-9A-Z- &amp;quot;]{1})([ 0-9A-Z&amp;amp;] ' \" . / ° \"\\( \\) À É È Ì Ò Ù Ú &amp;quot; \\\" \\+)*</td> </tr> </tbody> </table>	Kind	Value	pattern	([0-9A-Z- &quot;]{1})([ 0-9A-Z&amp;] ' \" . / ° \"\\( \\) À É È Ì Ò Ù Ú &quot; \\\" \\+)*
Kind	Value				
pattern	([0-9A-Z- &quot;]{1})([ 0-9A-Z&amp;] ' \" . / ° \"\\( \\) À É È Ì Ò Ù Ú &quot; \\\" \\+)*				

element **Primo\_Modulo\_PL\_Type/Prospetto/LiquidazioneImposte/PrimaRataAcclrpef**

diagram					
namespace	urn:www.agenziaentrate.gov.it:specificheTecniche:sco:730				
type	<a href="#">DatoNP_Type</a>				
facets	<table border="1"> <thead> <tr> <th>Kind</th> <th>Value</th> </tr> </thead> <tbody> <tr> <td>pattern</td> <td>[1-9]{1}[0-9]*</td> </tr> </tbody> </table>	Kind	Value	pattern	[1-9]{1}[0-9]*
Kind	Value				
pattern	[1-9]{1}[0-9]*				

element **Primo\_Modulo\_PL\_Type/Prospetto/LiquidazioneImposte/SecondaRataAcclrpef**

diagram					
namespace	urn:www.agenziaentrate.gov.it:specificheTecniche:sco:730				
type	<a href="#">DatoNP_Type</a>				
facets	<table border="1"> <thead> <tr> <th>Kind</th> <th>Value</th> </tr> </thead> <tbody> <tr> <td>pattern</td> <td>[1-9]{1}[0-9]*</td> </tr> </tbody> </table>	Kind	Value	pattern	[1-9]{1}[0-9]*
Kind	Value				
pattern	[1-9]{1}[0-9]*				

element **Primo\_Modulo\_PL\_Type/Prospetto/LiquidazioneImposte/AccontoTassSep**

diagram	
namespace	urn:www.agenziaentrate.gov.it:specificheTecniche:sco:730
type	<a href="#">m730:Debito_Type</a>
children	<a href="#">m730:NonVersare</a> <a href="#">m730:ImportoDaTrattenere</a>

element **Primo\_Modulo\_PL\_Type/Prospetto/LiquidazioneImposte/AccontoAddComunale**

diagram	
namespace	urn:www.agenziaentrate.gov.it:specificheTecniche:sco:730
children	<a href="#">m730:CodiceAddComAcconto</a> <a href="#">m730:AccontoAddCom</a>

element **Primo\_Modulo\_PL\_Type/Prospetto/LiquidazioneImposte/AccontoAddComunale/CodiceAddComAcconto**

diagram					
namespace	urn:www.agenziaentrate.gov.it:specificheTecniche:sco:730				
type	<a href="#">DatoAN_Type</a>				
facets	<table border="1"> <thead> <tr> <th>Kind</th> <th>Value</th> </tr> </thead> <tbody> <tr> <td>pattern</td> <td>(([0-9A-Z-] \&amp;quot;){1}([ 0-9A-Z&amp;amp;:] \- \., / ^\\(\\ \\) À É Ì Ò Ù Ú &amp;quot; \\ \\ \\ +)*</td> </tr> </tbody> </table>	Kind	Value	pattern	(([0-9A-Z-] \&quot;){1}([ 0-9A-Z&amp;:] \- \., / ^\\(\\ \\) À É Ì Ò Ù Ú &quot; \\ \\ \\ +)*
Kind	Value				
pattern	(([0-9A-Z-] \&quot;){1}([ 0-9A-Z&amp;:] \- \., / ^\\(\\ \\) À É Ì Ò Ù Ú &quot; \\ \\ \\ +)*				

element **Primo\_Modulo\_PL\_Type/Prospetto/LiquidazioneImposte/AccontoAddComunale/AccontoAddCom**

diagram					
namespace	urn:www.agenziaentrate.gov.it:specificheTecniche:sco:730				
type	<a href="#">DatoNP_Type</a>				
facets	<table border="1"> <thead> <tr> <th>Kind</th> <th>Value</th> </tr> </thead> <tbody> <tr> <td>pattern</td> <td>[1-9]{1}[0-9]*</td> </tr> </tbody> </table>	Kind	Value	pattern	[1-9]{1}[0-9]*
Kind	Value				
pattern	[1-9]{1}[0-9]*				

element **Primo\_Modulo\_PL\_Type/Prospetto/LiquidazioneImposte/ImpostaSostitutiva**

diagram	
namespace	urn:www.agenziaentrate.gov.it:specificheTecniche:sco:730
type	<a href="#">m730:Debito_Type</a>
children	<a href="#">m730:NonVersare</a> <a href="#">m730:ImportoDaTrattenere</a>

element **Primo\_Modulo\_PL\_Type/Prospetto/LiquidazioneImposte/EsitoCedolareSecca**

diagram	
namespace	urn:www.agenziaentrate.gov.it:specificheTecniche:sco:730
type	<a href="#">m730:Esito_Liquidazione_Type</a>
children	<a href="#">m730:Credito</a> <a href="#">m730:Debito</a>

element **Primo\_Modulo\_PL\_Type/Prospetto/LiquidazioneImposte/PrimaRataAccCedolare**

diagram					
namespace	urn:www.agenziaentrate.gov.it:specificheTecniche:sco:730				
type	<a href="#">DatoNP_Type</a>				
facets	<table border="1"> <tr> <td>Kind</td> <td>Value</td> </tr> <tr> <td>pattern</td> <td>[1-9]{1}[0-9]*</td> </tr> </table>	Kind	Value	pattern	[1-9]{1}[0-9]*
Kind	Value				
pattern	[1-9]{1}[0-9]*				

element **Primo\_Modulo\_PL\_Type/Prospetto/LiquidazioneImposte/SecondaRataAccCedolare**

diagram					
namespace	urn:www.agenziaentrate.gov.it:specificheTecniche:sco:730				
type	<a href="#">DatoNP_Type</a>				
facets	<table border="1"> <tr> <td>Kind</td> <td>Value</td> </tr> <tr> <td>pattern</td> <td>[1-9]{1}[0-9]*</td> </tr> </table>	Kind	Value	pattern	[1-9]{1}[0-9]*
Kind	Value				
pattern	[1-9]{1}[0-9]*				

element **Primo\_Modulo\_PL\_Type/Prospetto/AltriDati**

<p>diagram</p>	
<p>namespace</p>	<p>urn:www.agenziaentrate.gov.it:specificheTecniche:sco:730</p>
<p>type</p>	<p><a href="#">m730:Altri_Dati_Type</a></p>
<p>children</p>	<p> <a href="#">m730:ResiduoCreditoErogazioneCultura</a> <a href="#">m730:ResiduoCreditoPrimaCasa</a> <a href="#">m730:ResiduoCreditoOccupazione</a> <a href="#">m730:ResiduoCreditoSisma</a> <a href="#">m730:ResiduoCreditoFondiPensione</a> <a href="#">m730:ResiduoCreditoMediazioni</a> <a href="#">m730:TotSpeseSanitarieRateizzate</a> <a href="#">m730:RedditoAgevolazioniFiscali</a> <a href="#">m730:RedditoComplessivoAcconto</a> <a href="#">m730:RigoDifferenzaAcconto</a> <a href="#">m730:AccontiCompensatiIntern</a> <a href="#">m730:RedditiFondiariniNonImponibili</a> <a href="#">m730:RedditoAbitazionePrincipalePertinenze</a> <a href="#">m730:ResiduoDeduzioneSommeRestituite</a> <a href="#">m730:ResiduoErogazioniScuola</a> <a href="#">m730:ResiduoCreditoNegoziazione</a> <a href="#">m730:ResiduoCreditoVideosorveglianza</a> <a href="#">m730:CreditoErogazioneCultura</a> </p>

element **Primo\_Modulo\_PL\_Type/Prospetto/CredImpEstero**

<p>diagram</p>	<p>The diagram illustrates the structure of the <code>m730:CredImpEstero</code> element. It is a complex type (represented by a dashed box) containing three child elements: <code>m730:Anno</code>, <code>m730:TotCredito</code>, and <code>m730:CreditoStato</code>. The <code>m730:CreditoStato</code> element has a cardinality of <code>1..2</code>, indicating it can occur once or twice. The <code>m730:CreditoStato</code> element is also marked as a total participation element (indicated by a plus sign in a square).</p>
<p>namespace</p>	<p>urn:www.agenziaentrate.gov.it:specificheTecniche:sco:730</p>
<p>type</p>	<p><a href="#">m730:Cred_Imp_Estero_Type</a></p>
<p>children</p>	<p><a href="#">m730:Anno</a> <a href="#">m730:TotCredito</a> <a href="#">m730:CreditoStato</a></p>

element **Primo\_Modulo\_PL\_Type/Prospetto/DatiCreditiF24**

<p>diagram</p>	
<p>namespace</p>	<p>urn:www.agenziaentrate.gov.it:specificheTecniche:sco:730</p>
<p>type</p>	<p><a href="#">m730:Crediti_F24_Type</a></p>
<p>children</p>	<p><a href="#">m730:Credlrpef</a> <a href="#">m730:CredlrpefDipNoSostituto</a> <a href="#">m730:CodAddReg</a> <a href="#">m730:CredAddReg</a>  <a href="#">m730:CredAddRegDipNoSostituto</a> <a href="#">m730:CodiceAddCom</a> <a href="#">m730:CredAddCom</a> <a href="#">m730:CredAddComDipNoSostituto</a>  <a href="#">m730:CredCedolare</a> <a href="#">m730:CredCedolareDipNoSostituto</a> <a href="#">m730:CredTassSeparDipNoSostituto</a>  <a href="#">m730:CredImpostaSostDipNoSostituto</a> <a href="#">m730:Totale</a> <a href="#">m730:TotaleDipNoSostituto</a></p>

element **Primo\_Modulo\_PL\_Type/ProspettoRideterminato**

diagram	
namespace	urn:www.agenziaentrate.gov.it:specificheTecniche:sco:730
type	extension of <a href="#">m730:Prospetto_Type</a>
children	<a href="#">m730:RiepilogoRedditi</a> <a href="#">m730:ImpostaLorda</a> <a href="#">m730:DetrazioniCrediti</a> <a href="#">m730:ImpostaNetta</a> <a href="#">m730:RedditoAgevolazioniFiscali</a>

element **Primo\_Modulo\_PL\_Type/ProspettoRideterminato/RedditoAgevolazioniFiscali**

diagram					
namespace	urn:www.agenziaentrate.gov.it:specificheTecniche:sco:730				
type	<a href="#">DatoNP_Type</a>				
facets	<table border="1"> <thead> <tr> <th>Kind</th> <th>Value</th> </tr> </thead> <tbody> <tr> <td>pattern</td> <td>[1-9]{1}[0-9]*</td> </tr> </tbody> </table>	Kind	Value	pattern	[1-9]{1}[0-9]*
Kind	Value				
pattern	[1-9]{1}[0-9]*				

complexType **Prospetto\_Annotazioni\_Type**

diagram	
namespace	urn:www.agenziaentrate.gov.it:specificheTecniche:sco:730
children	<a href="#">m730:Modulo_Annotazioni</a>

element **Prospetto\_Annotazioni\_Type/Modulo\_Annotazioni**

diagram	
namespace	urn:www.agenziaentrate.gov.it:specificheTecniche:sco:730



type	<a href="#">m730:Modulo Annotazioni Type</a>
children	<a href="#">m730:Annotazione</a>

#### complexType [Prospetto\\_Liquidazione\\_Type](#)

diagram	
namespace	urn:www.agenziaentrate.gov.it:specificheTecniche:sco:730
children	<a href="#">m730:PrimoModulo</a> <a href="#">m730:Modulo</a>

#### element [Prospetto\\_Liquidazione\\_Type/PrimoModulo](#)

diagram	
namespace	urn:www.agenziaentrate.gov.it:specificheTecniche:sco:730
type	<a href="#">m730:Primo Modulo PL Type</a>
children	<a href="#">m730:Prospetto</a> <a href="#">m730:ProspettoRideterminato</a>

#### element [Prospetto\\_Liquidazione\\_Type/Modulo](#)

diagram	
namespace	urn:www.agenziaentrate.gov.it:specificheTecniche:sco:730
type	<a href="#">m730:Modulo PL Type</a>
children	<a href="#">m730:CredImpEstero</a>

complexType **Prospetto\_Type**

diagram	
namespace	urn:www.agenziaentrate.gov.it:specificheTecniche:sco:730
children	<a href="#">m730:RiepilogoRedditi</a> <a href="#">m730:ImpostaLorda</a> <a href="#">m730:DetrazioniCrediti</a> <a href="#">m730:ImpostaNetta</a>

element **Prospetto\_Type/RiepilogoRedditi**

diagram	
namespace	urn:www.agenziaentrate.gov.it:specificheTecniche:sco:730
type	<a href="#">m730:Riepilogo_Redditi_Type</a>
children	<a href="#">m730:Dominicali</a> <a href="#">m730:Agrari</a> <a href="#">m730:Fabbricati</a> <a href="#">m730:LavDip</a> <a href="#">m730:AltriRedditi</a> <a href="#">m730:ImponibileCedolare</a> <a href="#">m730:ImponibileCedolareOrdinario</a> <a href="#">m730:ImponibileCedolareAgevolato</a> <a href="#">m730:AbitazionePrincipalePertinenze</a>

element **Prospetto\_Type/ImpostaLorda**

<p>diagram</p>	<pre> classDiagram     class m730:ImpostaLorda     class m730:Imposta_Lorda_Type     class m730:RedditoComplessivo     class m730:DeduzioneAbitazPrincipale     class m730:OneriDeducibili     class m730:RedditoImponibile     class m730:CompensiAttSport     class m730:ImportoImpostaLorda      m730:ImpostaLorda "1" *-- "1" m730:Imposta_Lorda_Type     m730:Imposta_Lorda_Type "1" *-- "1" m730:RedditoComplessivo     m730:Imposta_Lorda_Type "1" *-- "1" m730:DeduzioneAbitazPrincipale     m730:Imposta_Lorda_Type "1" *-- "1" m730:OneriDeducibili     m730:Imposta_Lorda_Type "1" *-- "1" m730:RedditoImponibile     m730:Imposta_Lorda_Type "1" *-- "1" m730:CompensiAttSport     m730:Imposta_Lorda_Type "1" *-- "1" m730:ImportoImpostaLorda     </pre>
<p>namespace</p>	<p>urn:www.agenziaentrato.gov.it:specificheTecniche:sco:730</p>
<p>type</p>	<p><a href="#">m730:Imposta_Lorda_Type</a></p>
<p>children</p>	<p><a href="#">m730:RedditoComplessivo</a> <a href="#">m730:DeduzioneAbitazPrincipale</a> <a href="#">m730:OneriDeducibili</a> <a href="#">m730:RedditoImponibile</a> <a href="#">m730:CompensiAttSport</a> <a href="#">m730:ImportoImpostaLorda</a></p>

element **Prospetto\_Type/DetrazioniCrediti**

<p>diagram</p>	
<p>namespace</p>	<p>urn:www.agenziaentrate.gov.it:specificheTecniche:sco:730</p>
<p>type</p>	<p><a href="#">m730:Detrazione_Crediti_Type</a></p>
<p>children</p>	<p><a href="#">m730:DetrazioneConiuge</a> <a href="#">m730:DetrazioneFigli</a> <a href="#">m730:UlterioreDetrazioneFigli</a> <a href="#">m730:DetrazioneFamiliari</a> <a href="#">m730:DetrazioneLavDip</a> <a href="#">m730:DetrazionePens</a> <a href="#">m730:DetrazioneAltriRedditi</a> <a href="#">m730:DetrazioneOneri</a></p>

[m730:DetrazioneRistrutturazione](#) [m730:DetrazioniArredolImmobili](#) [m730:DetrazioneRisparmioEnergetico](#)  
[m730:DetrazioneArredoGiovaniCoppie](#) [m730:DetrazionelvaAcquistoAbitaz](#) [m730:DetrazioneLocEAgricoliGiovani](#)  
[m730:AltreDetrazioni](#) [m730:CreditoPrimaCasa](#) [m730:CreditoOccupazione](#) [m730:CreditoFondiPensione](#)  
[m730:CreditoMediazioni](#) [m730:CreditoNegoziazione](#) [m730:TotaleDetrazioniCrediti](#)

element **Prospetto\_Type/ImpostaNetta**

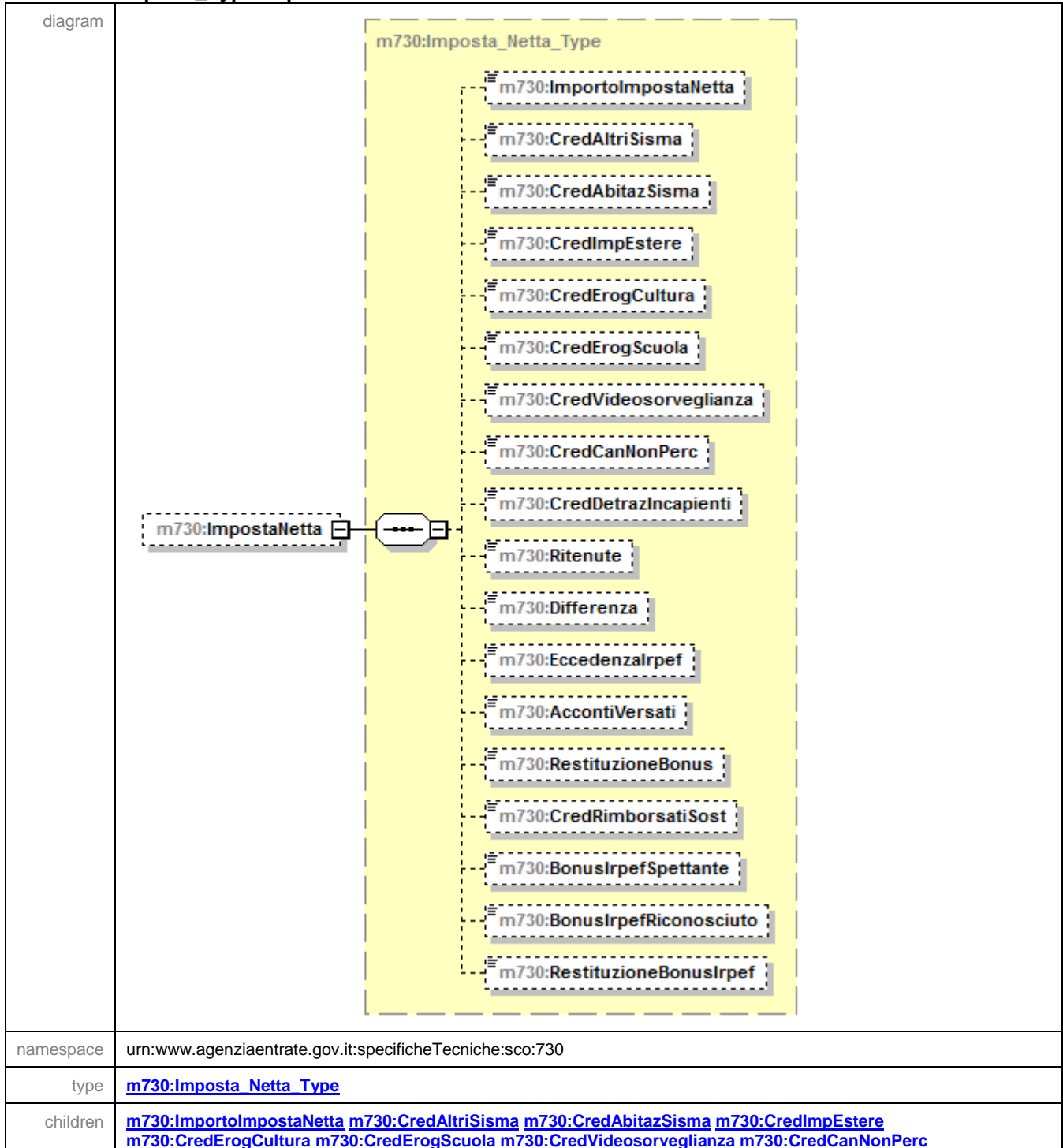

	<a href="#">m730:CredDetrazIncapienti</a> <a href="#">m730:Ritenute</a> <a href="#">m730:Differenza</a> <a href="#">m730:EccedenzaIrpef</a> <a href="#">m730:AccontiVersati</a> <a href="#">m730:RestituzioneBonus</a> <a href="#">m730:CredRimborsatiSost</a> <a href="#">m730:BonusIrpefSpettante</a> <a href="#">m730:BonusIrpefRiconosciuto</a> <a href="#">m730:RestituzioneBonusIrpef</a>
--	---

### complexType Quadro\_I\_Type

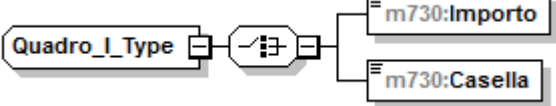
diagram	
namespace	urn:www.agenziaentrate.gov.it:specificheTecniche:sco:730
children	<a href="#">m730:Importo</a> <a href="#">m730:Casella</a>

### element Quadro\_I\_Type/Importo

diagram					
namespace	urn:www.agenziaentrate.gov.it:specificheTecniche:sco:730				
type	<a href="#">DatoNP_Type</a>				
facets	<table border="1"> <tr> <td>Kind</td> <td>Value</td> </tr> <tr> <td>pattern</td> <td>[1-9]{1}[0-9]*</td> </tr> </table>	Kind	Value	pattern	[1-9]{1}[0-9]*
Kind	Value				
pattern	[1-9]{1}[0-9]*				

### element Quadro\_I\_Type/Casella

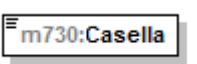
diagram					
namespace	urn:www.agenziaentrate.gov.it:specificheTecniche:sco:730				
type	<a href="#">DatoCB_Type</a>				
facets	<table border="1"> <tr> <td>Kind</td> <td>Value</td> </tr> <tr> <td>pattern</td> <td>[01]</td> </tr> </table>	Kind	Value	pattern	[01]
Kind	Value				
pattern	[01]				

### complexType Quadro\_K\_Type

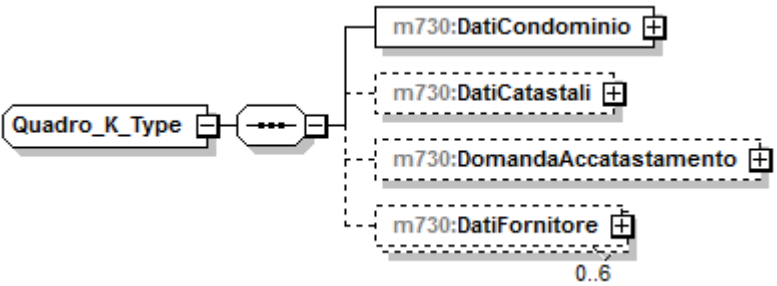
diagram	
namespace	urn:www.agenziaentrate.gov.it:specificheTecniche:sco:730
children	<a href="#">m730:DatiCondominio</a> <a href="#">m730:DatiCatastali</a> <a href="#">m730:DomandaAccatastamento</a> <a href="#">m730:DatiFornitore</a>

element **Quadro\_K\_Type/DatiCondominio**

diagram	
namespace	urn:www.agenziaentrate.gov.it:specificheTecniche:sco:730
type	<a href="#">m730:Dati_Condominio_Type</a>
children	<a href="#">m730:CodiceFiscale</a> <a href="#">m730:Denominazione</a>

element **Quadro\_K\_Type/DatiCatastali**

diagram	
namespace	urn:www.agenziaentrate.gov.it:specificheTecniche:sco:730
type	<a href="#">m730:Dati_Catastali_Type</a>
children	<a href="#">m730:CodiceComune</a> <a href="#">m730:TerreniUrbano</a> <a href="#">m730:SezioneUrbanaComuneCatastale</a> <a href="#">m730:Foglio</a> <a href="#">m730:Particella</a> <a href="#">m730:Subalterno</a>

element **Quadro\_K\_Type/DomandaAccatastamento**

diagram	
namespace	urn:www.agenziaentrate.gov.it:specificheTecniche:sco:730
type	<a href="#">m730:Domanda_Accatastamento_Type</a>
children	<a href="#">m730:Data</a> <a href="#">m730:Numero</a> <a href="#">m730:ProvinciaUfficio</a>

namespace	urn:www.agenziaentrate.gov.it:specificheTecniche:sco:730
type	<a href="#">m730:Domanda Accatastamento Type</a>
children	<a href="#">m730:Data</a> <a href="#">m730:Numero</a> <a href="#">m730:ProvinciaUfficio</a>

element **Quadro\_K\_Type/DatiFornitore**

diagram	
namespace	urn:www.agenziaentrate.gov.it:specificheTecniche:sco:730
type	<a href="#">m730:Dati Fornitore Type</a>
children	<a href="#">m730:CodiceFiscale</a> <a href="#">m730:CognomeDenom</a> <a href="#">m730:Nome</a> <a href="#">m730:Sesso</a> <a href="#">m730:DataNascita</a> <a href="#">m730:ComuneNascita</a> <a href="#">m730:ProvinciaNascita</a> <a href="#">m730:ImportoAcquisti</a> <a href="#">m730:StatoEstero</a>

complexType **Rappresentante\_Type**

diagram	
namespace	urn:www.agenziaentrate.gov.it:specificheTecniche:sco:730
children	<a href="#">m730:SoggettoFiscale</a> <a href="#">m730:DatiAnagrafici</a> <a href="#">m730:ResidenzaAnagrafica</a> <a href="#">m730:Firma</a>



element **Rappresentante\_Type/SoggettoFiscale**

diagram	
namespace	urn:www.agenziaentrate.gov.it:specificheTecniche:sco:730
type	<a href="#">m730:Soggetto_Fiscale_730_Type</a>
children	<a href="#">m730:CodiceFiscale</a> <a href="#">m730:Email</a> <a href="#">m730:Telefono</a> <a href="#">m730:Cellulare</a>

element **Rappresentante\_Type/DatiAnagrafici**

diagram	
namespace	urn:www.agenziaentrate.gov.it:specificheTecniche:sco:730
type	<a href="#">Dati_Anagrafici_Type</a>
children	<a href="#">Cognome</a> <a href="#">Nome</a> <a href="#">Sesso</a> <a href="#">DataNascita</a> <a href="#">ComuneNascita</a> <a href="#">ProvinciaNascita</a>

element **Rappresentante\_Type/ResidenzaAnagrafica**

diagram	
namespace	urn:www.agenziaentrate.gov.it:specificheTecniche:sco:730
type	<a href="#">m730:Residenza_Rappresentante_Type</a>
children	<a href="#">Comune</a> <a href="#">Provincia</a> <a href="#">CodiceComune</a> <a href="#">Indirizzo</a> <a href="#">Cap</a> <a href="#">m730:Tipologia</a> <a href="#">m730:NumCivico</a> <a href="#">m730:Frazione</a>

element **Rappresentante\_Type/Firma**

diagram	
namespace	urn:www.agenziaentrate.gov.it:specificheTecniche:sco:730
type	<a href="#">DatoCB_Type</a>
facets	Kind Value pattern [01]

complexType **Redditi\_Capitale\_Type**

diagram	
namespace	urn:www.agenziaentrate.gov.it:specificheTecniche:sco:730

children	<a href="#">m730:Utili</a> <a href="#">m730:AltriRedditiDiCapitale</a> <a href="#">m730:LavoroAutonomo</a> <a href="#">m730:RedditiDiversi</a> <a href="#">m730:RedditiDiversiDetraz</a>
----------	--

element **Redditi\_Capitale\_Type/Utili**

diagram	
namespace	urn:www.agenziaentrate.gov.it:specificheTecniche:sco:730
type	<a href="#">m730:Altri_Redditi_Utili_Type</a>
children	<a href="#">m730:Tipo_Reddito</a> <a href="#">m730:RedditiRitenute</a>

element **Redditi\_Capitale\_Type/AltriRedditiDiCapitale**

diagram	
namespace	urn:www.agenziaentrate.gov.it:specificheTecniche:sco:730
type	<a href="#">m730:Sezione_Altri_Redd_Type</a>
children	<a href="#">m730:TipoReddito</a> <a href="#">m730:RedditiRitenute</a>

element **Redditi\_Capitale\_Type/LavoroAutonomo**

diagram	
namespace	urn:www.agenziaentrate.gov.it:specificheTecniche:sco:730
type	<a href="#">m730:Altri_Redditi_Lavoro_Autonomo_Type</a>
children	<a href="#">m730:TipoReddito</a> <a href="#">m730:RedditiRitenute</a>

element **Redditi\_Capitale\_Type/RedditiDiversi**

diagram	
namespace	urn:www.agenziaentrate.gov.it:specificheTecniche:sco:730
type	<a href="#">m730:Altri_Redditi_Diversi_Type</a>
children	<a href="#">m730:CedolareSecca</a> <a href="#">m730:TipoReddito</a> <a href="#">m730:RedditiRitenuteSpese</a>

element **Redditi\_Capitale\_Type/RedditiDiversiDetraz**

diagram	
namespace	urn:www.agenziaentrate.gov.it:specificheTecniche:sco:730
type	<a href="#">m730:Altri_Redditi_Diversi_Detr_Type</a>
children	<a href="#">m730:Tipo_Reddito</a> <a href="#">m730:RedditiRitenuteSpese</a>

complexType **Redditi\_Eredi\_Legatari\_Type**

diagram	
namespace	urn:www.agenziaentrate.gov.it:specificheTecniche:sco:730

type	extension of <a href="#">m730:Tassazione Separata Type</a>
children	<a href="#">m730:Opzione</a> <a href="#">m730:Anno</a> <a href="#">m730:RedditoRitenute</a> <a href="#">m730:TipoReddito</a> <a href="#">m730:RedditoTotale</a> <a href="#">m730:QuotalmposteSuccessioni</a>

#### element **Redditi\_Eredi\_Legatari\_Type/TipoReddito**

diagram																																			
namespace	urn:www.agenziaentrate.gov.it:specificheTecniche:sco:730																																		
type	restriction of <a href="#">DatoNP Type</a>																																		
facets	<table border="1"> <thead> <tr> <th>Kind</th> <th>Value</th> </tr> </thead> <tbody> <tr> <td>pattern</td> <td>[1-9]{1}[0-9]*</td> </tr> <tr> <td>enumeration</td> <td>1</td> </tr> <tr> <td>enumeration</td> <td>2</td> </tr> <tr> <td>enumeration</td> <td>3</td> </tr> <tr> <td>enumeration</td> <td>4</td> </tr> <tr> <td>enumeration</td> <td>5</td> </tr> <tr> <td>enumeration</td> <td>6</td> </tr> <tr> <td>enumeration</td> <td>7</td> </tr> <tr> <td>enumeration</td> <td>8</td> </tr> <tr> <td>enumeration</td> <td>9</td> </tr> <tr> <td>enumeration</td> <td>10</td> </tr> <tr> <td>enumeration</td> <td>11</td> </tr> <tr> <td>enumeration</td> <td>12</td> </tr> <tr> <td>enumeration</td> <td>13</td> </tr> <tr> <td>enumeration</td> <td>14</td> </tr> <tr> <td>enumeration</td> <td>15</td> </tr> </tbody> </table>	Kind	Value	pattern	[1-9]{1}[0-9]*	enumeration	1	enumeration	2	enumeration	3	enumeration	4	enumeration	5	enumeration	6	enumeration	7	enumeration	8	enumeration	9	enumeration	10	enumeration	11	enumeration	12	enumeration	13	enumeration	14	enumeration	15
Kind	Value																																		
pattern	[1-9]{1}[0-9]*																																		
enumeration	1																																		
enumeration	2																																		
enumeration	3																																		
enumeration	4																																		
enumeration	5																																		
enumeration	6																																		
enumeration	7																																		
enumeration	8																																		
enumeration	9																																		
enumeration	10																																		
enumeration	11																																		
enumeration	12																																		
enumeration	13																																		
enumeration	14																																		
enumeration	15																																		

#### element **Redditi\_Eredi\_Legatari\_Type/RedditoTotale**

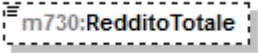
diagram					
namespace	urn:www.agenziaentrate.gov.it:specificheTecniche:sco:730				
type	<a href="#">DatoNP Type</a>				
facets	<table border="1"> <thead> <tr> <th>Kind</th> <th>Value</th> </tr> </thead> <tbody> <tr> <td>pattern</td> <td>[1-9]{1}[0-9]*</td> </tr> </tbody> </table>	Kind	Value	pattern	[1-9]{1}[0-9]*
Kind	Value				
pattern	[1-9]{1}[0-9]*				

#### element **Redditi\_Eredi\_Legatari\_Type/QuotalmposteSuccessioni**

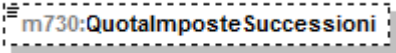
diagram					
namespace	urn:www.agenziaentrate.gov.it:specificheTecniche:sco:730				
type	<a href="#">DatoNP Type</a>				
facets	<table border="1"> <thead> <tr> <th>Kind</th> <th>Value</th> </tr> </thead> <tbody> <tr> <td>pattern</td> <td>[1-9]{1}[0-9]*</td> </tr> </tbody> </table>	Kind	Value	pattern	[1-9]{1}[0-9]*
Kind	Value				
pattern	[1-9]{1}[0-9]*				

complexType **Redditi\_Fabbricati\_Type**

diagram	
namespace	urn:www.agenziaentrategov.it:specificheTecniche:sco:730
children	<a href="#">m730:Modulo</a>

element **Redditi\_Fabbricati\_Type/Modulo**

diagram	
namespace	urn:www.agenziaentrategov.it:specificheTecniche:sco:730
type	<a href="#">m730:Modulo_Fabbricato_Type</a>
children	<a href="#">m730:FabbricatoOrd</a> <a href="#">m730:FabbricatoAgev</a>

complexType **Redditi\_Lavoro\_Dip\_Type**

diagram	
namespace	urn:www.agenziaentrategov.it:specificheTecniche:sco:730
children	<a href="#">m730:PrimoModulo</a> <a href="#">m730:Modulo</a>

element **Redditi\_Lavoro\_Dip\_Type/PrimoModulo**

<p>diagram</p>	
<p>namespace</p>	<p>urn:www.agenziaentrate.gov.it:specificheTecniche:sco:730</p>
<p>type</p>	<p><a href="#">m730:Primo_Modulo_Lavoro_Dip_Type</a></p>
<p>children</p>	<p><a href="#">m730:LavoroDipendente</a> <a href="#">m730:PremiRisultato</a> <a href="#">m730:PeriodoLavoro</a> <a href="#">m730:AltriRedditiAssLavDip</a>  <a href="#">m730:RitenuteLavoroDipendente</a> <a href="#">m730:Bonuslrpef</a> <a href="#">m730:CasellaCasiParticolari</a></p>

element **Redditi\_Lavoro\_Dip\_Type/Modulo**

<p>diagram</p>	
<p>namespace</p>	<p>urn:www.agenziaentrate.gov.it:specificheTecniche:sco:730</p>
<p>type</p>	<p><a href="#">m730:Modulo_Lavoro_Dip_Type</a></p>
<p>children</p>	<p><a href="#">m730:LavoroDipendente</a> <a href="#">m730:PremiRisultato</a> <a href="#">m730:AltriRedditiAssLavDip</a> <a href="#">m730:Bonuslrpef</a></p>

### complexType Redditi\_Ritenute\_Spese\_Type

diagram	
namespace	urn:www.agenziaentrate.gov.it:specificheTecniche:sco:730
type	extension of <a href="#">m730:Redditi_Ritenute_Type</a>
children	<a href="#">m730:ImportoRedditi</a> <a href="#">m730:ImportoRitenute</a> <a href="#">m730:ImportoSpese</a>

### element Redditi\_Ritenute\_Spese\_Type/ImportoSpese

diagram					
namespace	urn:www.agenziaentrate.gov.it:specificheTecniche:sco:730				
type	<a href="#">DatoNP_Type</a>				
facets	<table border="1"> <thead> <tr> <th>Kind</th> <th>Value</th> </tr> </thead> <tbody> <tr> <td>pattern</td> <td>[1-9]{1}[0-9]*</td> </tr> </tbody> </table>	Kind	Value	pattern	[1-9]{1}[0-9]*
Kind	Value				
pattern	[1-9]{1}[0-9]*				

### complexType Redditi\_Ritenute\_Type

diagram	
namespace	urn:www.agenziaentrate.gov.it:specificheTecniche:sco:730
children	<a href="#">m730:ImportoRedditi</a> <a href="#">m730:ImportoRitenute</a>

### element Redditi\_Ritenute\_Type/ImportoRedditi

diagram					
namespace	urn:www.agenziaentrate.gov.it:specificheTecniche:sco:730				
type	<a href="#">DatoNP_Type</a>				
facets	<table border="1"> <thead> <tr> <th>Kind</th> <th>Value</th> </tr> </thead> <tbody> <tr> <td>pattern</td> <td>[1-9]{1}[0-9]*</td> </tr> </tbody> </table>	Kind	Value	pattern	[1-9]{1}[0-9]*
Kind	Value				
pattern	[1-9]{1}[0-9]*				



element **Redditi\_Ritenute\_Type/ImportoRitenute**

diagram	
namespace	urn:www.agenziaentrate.gov.it:specificheTecniche:sco:730
type	<a href="#">DatoNP_Type</a>
facets	Kind Value pattern [1-9]{1}[0-9]*

complexType **Redditi\_Tassazione\_Separata\_Type**

diagram	
namespace	urn:www.agenziaentrate.gov.it:specificheTecniche:sco:730
children	<a href="#">m730:RedditiErede</a> <a href="#">m730:ImposteRimborsate</a>

element **Redditi\_Tassazione\_Separata\_Type/RedditiErede**

diagram	
namespace	urn:www.agenziaentrate.gov.it:specificheTecniche:sco:730
type	<a href="#">m730:Redditi Eredi Legatari_Type</a>
children	<a href="#">m730:Opzione</a> <a href="#">m730:Anno</a> <a href="#">m730:RedditoRitenute</a> <a href="#">m730:TipoReddito</a> <a href="#">m730:RedditoTotale</a> <a href="#">m730:QuotaImposteSuccessioni</a>

element **Redditi\_Tassazione\_Separata\_Type/ImposteRimborsate**

diagram	
namespace	urn:www.agenziaentrate.gov.it:specificheTecniche:sco:730
type	<a href="#">m730:Imposte_Rimborsate_Type</a>
children	<a href="#">m730:TipoReddito</a> <a href="#">m730:TassazioneSeparata</a>

complexType **Redditi\_Terreni\_Type**

diagram	
namespace	urn:www.agenziaentrate.gov.it:specificheTecniche:sco:730
children	<a href="#">m730:Modulo</a>

element **Redditi\_Terreni\_Type/Modulo**

diagram	
namespace	urn:www.agenziaentrate.gov.it:specificheTecniche:sco:730
type	<a href="#">m730:Modulo_Terreno_Type</a>
children	<a href="#">m730:Terreno</a>

complexType **Reddito\_Erede\_Type**

diagram	
namespace	urn:www.agenziaentrate.gov.it:specificheTecniche:sco:730

type	extension of <a href="#">m730:Tassazione Separata Type</a>
children	<a href="#">m730:Opzione</a> <a href="#">m730:Anno</a> <a href="#">m730:RedditoRitenute</a>

complexType **Residenza\_Anagrafica\_730\_Type**

diagram	
namespace	urn:www.agenziaentrate.gov.it:specificheTecniche:sco:730
type	extension of <a href="#">Residenza_Anagrafica_Type</a>
children	<a href="#">Comune</a> <a href="#">Provincia</a> <a href="#">CodiceComune</a> <a href="#">Indirizzo</a> <a href="#">Cap</a> <a href="#">DataVariazione</a> <a href="#">m730:Tipologia</a> <a href="#">m730:NumCivico</a> <a href="#">m730:Frazione</a> <a href="#">m730:PrimaPresentazione</a>

element **Residenza\_Anagrafica\_730\_Type/Tipologia**

diagram					
namespace	urn:www.agenziaentrate.gov.it:specificheTecniche:sco:730				
type	<a href="#">DatoAN_Type</a>				
facets	<table border="1"> <tr> <td>Kind</td> <td>Value</td> </tr> <tr> <td>pattern</td> <td>([0-9A-Z\-\]]&amp;quot;){1}([ 0-9A-Z&amp;amp;:] ' - \- . \! \° \^\\( \) À È É Ì Ò Ù Ú &amp;quot; \\ / +)*</td> </tr> </table>	Kind	Value	pattern	([0-9A-Z\-\]]&quot;){1}([ 0-9A-Z&amp;:] ' - \- . \! \° \^\\( \) À È É Ì Ò Ù Ú &quot; \\ / +)*
Kind	Value				
pattern	([0-9A-Z\-\]]&quot;){1}([ 0-9A-Z&amp;:] ' - \- . \! \° \^\\( \) À È É Ì Ò Ù Ú &quot; \\ / +)*				

element **Residenza\_Anagrafica\_730\_Type/NumCivico**

diagram	
---------	--



children	<a href="#">Comune</a> <a href="#">Provincia</a> <a href="#">CodiceComune</a> <a href="#">Indirizzo</a> <a href="#">Cap</a> <a href="#">m730:Tipologia</a> <a href="#">m730:NumCivico</a> <a href="#">m730:Frazione</a>
----------	---

element **Residenza\_Rappresentante\_Type/Tipologia**

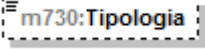
diagram	
namespace	urn:www.agenziaentrate.gov.it:specificheTecniche:sco:730
type	<a href="#">DatoAN_Type</a>
facets	Kind Value pattern ([0-9A-Z-]*)&quot;){1}([ 0-9A-Z&amp;:] [-\., / ^\\(\ )\ À É È Ì Ò Ù Ü &quot; \\ / +)*

element **Residenza\_Rappresentante\_Type/NumCivico**

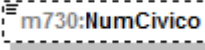
diagram	
namespace	urn:www.agenziaentrate.gov.it:specificheTecniche:sco:730
type	<a href="#">DatoAN_Type</a>
facets	Kind Value pattern ([0-9A-Z-]*)&quot;){1}([ 0-9A-Z&amp;:] [-\., / ^\\(\ )\ À É È Ì Ò Ù Ü &quot; \\ / +)*

element **Residenza\_Rappresentante\_Type/Frazione**

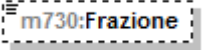
diagram	
namespace	urn:www.agenziaentrate.gov.it:specificheTecniche:sco:730
type	<a href="#">DatoAN_Type</a>
facets	Kind Value pattern ([0-9A-Z-]*)&quot;){1}([ 0-9A-Z&amp;:] [-\., / ^\\(\ )\ À É È Ì Ò Ù Ü &quot; \\ / +)*

complexType **Residenza\_Type**

diagram	
namespace	urn:www.agenziaentrate.gov.it:specificheTecniche:sco:730
children	<a href="#">m730:Comune</a> <a href="#">m730:Provincia</a> <a href="#">m730:CodiceComune</a> <a href="#">m730:Cap</a> <a href="#">m730:Tipologia</a> <a href="#">m730:Indirizzo</a> <a href="#">m730:NumCivico</a> <a href="#">m730:Frazione</a> <a href="#">m730:Email</a> <a href="#">m730:Telefono</a>

element **Residenza\_Type/Comune**

diagram					
namespace	urn:www.agenziaentrate.gov.it:specificheTecniche:sco:730				
type	<a href="#">DatoAN_Type</a>				
facets	<table border="0"> <tr> <td>Kind</td> <td>Value</td> </tr> <tr> <td>pattern</td> <td>(([0-9A-Z-] \&amp;quot;){1}([ 0-9A-Z&amp;amp;] \- \., / ^*\(\ \)\) À É È Ì Ò Ù Û &amp;quot; \ \\ +)*</td> </tr> </table>	Kind	Value	pattern	(([0-9A-Z-] \&quot;){1}([ 0-9A-Z&amp;] \- \., / ^*\(\ \)\) À É È Ì Ò Ù Û &quot; \ \\ +)*
Kind	Value				
pattern	(([0-9A-Z-] \&quot;){1}([ 0-9A-Z&amp;] \- \., / ^*\(\ \)\) À É È Ì Ò Ù Û &quot; \ \\ +)*				

element **Residenza\_Type/Provincia**

diagram	
namespace	urn:www.agenziaentrate.gov.it:specificheTecniche:sco:730
type	<a href="#">PR_Type</a>

element **Residenza\_Type/CodiceComune**

diagram	
---------	--

namespace	urn:www.agenziaentrate.gov.it:specificheTecniche:sco:730
type	<a href="#">DatoAN_Type</a>
facets	Kind Value pattern ([0-9A-Z\-\] &quot;){1}([ 0-9A-Z&amp;:] ' - \., / ^ \^\(\\) À É È Ì Ò Ù Ü &quot;; \\ / +)*

#### element **Residenza\_Type/Cap**

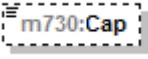
diagram	
namespace	urn:www.agenziaentrate.gov.it:specificheTecniche:sco:730
type	<a href="#">DatoAN_Type</a>
facets	Kind Value pattern ([0-9A-Z\-\] &quot;){1}([ 0-9A-Z&amp;:] ' - \., / ^ \^\(\\) À É È Ì Ò Ù Ü &quot;; \\ / +)*

#### element **Residenza\_Type/Tipologia**

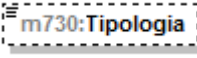
diagram	
namespace	urn:www.agenziaentrate.gov.it:specificheTecniche:sco:730
type	<a href="#">DatoAN_Type</a>
facets	Kind Value pattern ([0-9A-Z\-\] &quot;){1}([ 0-9A-Z&amp;:] ' - \., / ^ \^\(\\) À É È Ì Ò Ù Ü &quot;; \\ / +)*

#### element **Residenza\_Type/Indirizzo**

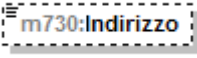
diagram	
namespace	urn:www.agenziaentrate.gov.it:specificheTecniche:sco:730
type	<a href="#">DatoAN_Type</a>
facets	Kind Value pattern ([0-9A-Z\-\] &quot;){1}([ 0-9A-Z&amp;:] ' - \., / ^ \^\(\\) À É È Ì Ò Ù Ü &quot;; \\ / +)*

#### element **Residenza\_Type/NumCivico**

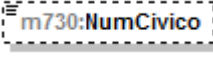
diagram	
namespace	urn:www.agenziaentrate.gov.it:specificheTecniche:sco:730
type	<a href="#">DatoAN_Type</a>
facets	Kind Value pattern ([0-9A-Z\-\] &quot;){1}([ 0-9A-Z&amp;:] ' - \., / ^ \^\(\\) À É È Ì Ò Ù Ü &quot;; \\ / +)*

### element **Residenza\_Type/Frazione**

diagram	
namespace	urn:www.agenziaentrate.gov.it:specificheTecniche:sco:730
type	<a href="#">DatoAN_Type</a>
facets	Kind Value pattern ([0-9A-Z-] \&quot;){1}([ 0-9A-Z&amp;:] \- \., / \^\(\ \)\ À É È Ì Ò Ù Û \&quot; \ \\ \ +)*

### element **Residenza\_Type/Email**

diagram	
namespace	urn:www.agenziaentrate.gov.it:specificheTecniche:sco:730
type	<a href="#">DatoEM_Type</a>
facets	Kind Value pattern [a-zA-Z0-9._%\-'\&quot;?^~=]+@[a-zA-Z0-9.\-]+\.[a-zA-Z]{2,4}

### element **Residenza\_Type/Telefono**

diagram	
namespace	urn:www.agenziaentrate.gov.it:specificheTecniche:sco:730
type	<a href="#">DatoAN_Type</a>
facets	Kind Value pattern ([0-9A-Z-] \&quot;){1}([ 0-9A-Z&amp;:] \- \., / \^\(\ \)\ À É È Ì Ò Ù Û \&quot; \ \\ \ +)*

### complexType **Residuo\_Credito\_Compens\_Annolmposta\_Type**

diagram	
namespace	urn:www.agenziaentrate.gov.it:specificheTecniche:sco:730
type	extension of <a href="#">m730:Residuo_Credito_Compens_Type</a>
children	<a href="#">m730:CreditoAnno</a> <a href="#">m730:DiCuiCompensatoF24</a>

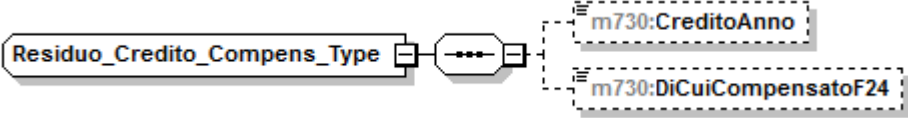

### complexType Residuo\_Credito\_Compens\_Type

diagram	
namespace	urn:www.agenziaentrate.gov.it:specificheTecniche:sco:730
children	<a href="#">m730:CreditoAnno</a> <a href="#">m730:DiCuiCompensatoF24</a>

### element Residuo\_Credito\_Compens\_Type/CreditoAnno

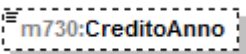
diagram					
namespace	urn:www.agenziaentrate.gov.it:specificheTecniche:sco:730				
type	<a href="#">DatoNP_Type</a>				
facets	<table border="1"> <tr> <td>Kind</td> <td>Value</td> </tr> <tr> <td>pattern</td> <td>[1-9]{1}[0-9]*</td> </tr> </table>	Kind	Value	pattern	[1-9]{1}[0-9]*
Kind	Value				
pattern	[1-9]{1}[0-9]*				

### element Residuo\_Credito\_Compens\_Type/DiCuiCompensatoF24

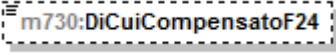
diagram					
namespace	urn:www.agenziaentrate.gov.it:specificheTecniche:sco:730				
type	<a href="#">DatoNP_Type</a>				
facets	<table border="1"> <tr> <td>Kind</td> <td>Value</td> </tr> <tr> <td>pattern</td> <td>[1-9]{1}[0-9]*</td> </tr> </table>	Kind	Value	pattern	[1-9]{1}[0-9]*
Kind	Value				
pattern	[1-9]{1}[0-9]*				

### complexType Residuo\_Fabbricati\_Type

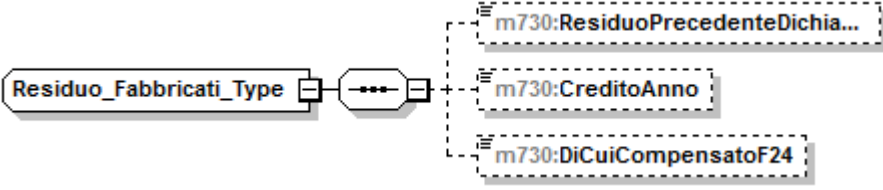
diagram	
namespace	urn:www.agenziaentrate.gov.it:specificheTecniche:sco:730
children	<a href="#">m730:ResiduoPrecedenteDichiarazione</a> <a href="#">m730:CreditoAnno</a> <a href="#">m730:DiCuiCompensatoF24</a>

### element Residuo\_Fabbricati\_Type/ResiduoPrecedenteDichiarazione

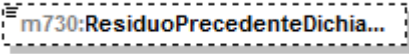
diagram	
namespace	urn:www.agenziaentrate.gov.it:specificheTecniche:sco:730
type	<a href="#">DatoNP_Type</a>

facets	Kind pattern	Value [1-9]{1}[0-9]*
--------	-----------------	-------------------------

#### element **Residuo\_Fabbricati\_Type/CreditoAnno**

diagram		
namespace	urn:www.agenziaentrate.gov.it:specificheTecniche:sco:730	
type	<a href="#">DatoNP_Type</a>	
facets	Kind pattern	Value [1-9]{1}[0-9]*

#### element **Residuo\_Fabbricati\_Type/DiCuiCompensatoF24**

diagram		
namespace	urn:www.agenziaentrate.gov.it:specificheTecniche:sco:730	
type	<a href="#">DatoNP_Type</a>	
facets	Kind pattern	Value [1-9]{1}[0-9]*

#### complexType **Restituzione\_Somme\_Type**

diagram	
namespace	urn:www.agenziaentrate.gov.it:specificheTecniche:sco:730
children	<a href="#">m730:SommeRestituite</a> <a href="#">m730:ResiduoPrecedenteDic</a>

#### element **Restituzione\_Somme\_Type/SommeRestituite**

diagram		
namespace	urn:www.agenziaentrate.gov.it:specificheTecniche:sco:730	
type	<a href="#">DatoNP_Type</a>	
facets	Kind pattern	Value [1-9]{1}[0-9]*

#### element **Restituzione\_Somme\_Type/ResiduoPrecedenteDic**

diagram	
namespace	urn:www.agenziaentrate.gov.it:specificheTecniche:sco:730

type	<a href="#">DatoNP_Type</a>
facets	Kind Value pattern [1-9]{1}[0-9]*

### complexType Rettifica\_Type

diagram	
namespace	urn:www.agenziaentrate.gov.it:specificheTecniche:sco:730
children	<a href="#">m730:Quadro</a> <a href="#">m730:Rigo</a> <a href="#">m730:Colonna</a> <a href="#">m730:Modulo</a> <a href="#">m730:DatoRimosso</a>

### element Rettifica\_Type/Quadro

diagram	
namespace	urn:www.agenziaentrate.gov.it:specificheTecniche:sco:730
type	<a href="#">DatoAN_Type</a>
facets	Kind Value pattern ([0-9A-Z\-\_]&quot;){1}([ 0-9A-Z&amp;#39; ! - \., / ^*\(\)\ À É È Ì Ò Ù Ú &quot; \ \\ /+)*

### element Rettifica\_Type/Rigo

diagram	
namespace	urn:www.agenziaentrate.gov.it:specificheTecniche:sco:730
type	<a href="#">DatoNP_Type</a>
facets	Kind Value pattern [1-9]{1}[0-9]*

### element Rettifica\_Type/Colonna

diagram	
namespace	urn:www.agenziaentrate.gov.it:specificheTecniche:sco:730
type	<a href="#">DatoNP_Type</a>
facets	Kind Value pattern [1-9]{1}[0-9]*

element **Rettifica\_Type/Modulo**

diagram	
namespace	urn:www.agenziaentrate.gov.it:specificheTecniche:sco:730
type	<a href="#">DatoNP_Type</a>
facets	Kind Value pattern [1-9]{1}[0-9]*

element **Rettifica\_Type/DatoRimosso**

diagram	
namespace	urn:www.agenziaentrate.gov.it:specificheTecniche:sco:730
type	<a href="#">DatoCB_Type</a>
facets	Kind Value pattern [01]

complexType **Riepilogo\_Redditi\_Type**

diagram	
namespace	urn:www.agenziaentrate.gov.it:specificheTecniche:sco:730
children	<a href="#">m730:Dominicali</a> <a href="#">m730:Agrari</a> <a href="#">m730:Fabbricati</a> <a href="#">m730:LavDip</a> <a href="#">m730:AltriRedditi</a> <a href="#">m730:ImponibileCedolare</a> <a href="#">m730:ImponibileCedolareOrdinario</a> <a href="#">m730:ImponibileCedolareAgevolato</a> <a href="#">m730:AbitazionePrincipalePertinenze</a>

**element Riepilogo\_Reddito\_Type/Dominicali**

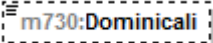
diagram	
namespace	urn:www.agenziaentrate.gov.it:specificheTecniche:sco:730
type	<a href="#">DatoNP_Type</a>
facets	Kind Value pattern [1-9]{1}[0-9]*

**element Riepilogo\_Reddito\_Type/Agrari**

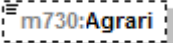
diagram	
namespace	urn:www.agenziaentrate.gov.it:specificheTecniche:sco:730
type	<a href="#">DatoNP_Type</a>
facets	Kind Value pattern [1-9]{1}[0-9]*

**element Riepilogo\_Reddito\_Type/Fabbricati**

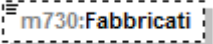
diagram	
namespace	urn:www.agenziaentrate.gov.it:specificheTecniche:sco:730
type	<a href="#">DatoNP_Type</a>
facets	Kind Value pattern [1-9]{1}[0-9]*

**element Riepilogo\_Reddito\_Type/LavDip**

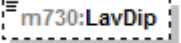
diagram	
namespace	urn:www.agenziaentrate.gov.it:specificheTecniche:sco:730
type	<a href="#">DatoNP_Type</a>
facets	Kind Value pattern [1-9]{1}[0-9]*

**element Riepilogo\_Reddito\_Type/AltriRedditi**

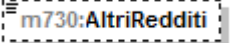
diagram	
namespace	urn:www.agenziaentrate.gov.it:specificheTecniche:sco:730
type	<a href="#">DatoNP_Type</a>
facets	Kind Value pattern [1-9]{1}[0-9]*

**element Riepilogo\_Redditi\_Type/ImponibileCedolare**

diagram	 m730:ImponibileCedolare
namespace	urn:www.agenziaentrate.gov.it:specificheTecniche:sco:730
type	<a href="#">DatoNP_Type</a>
facets	Kind Value pattern [1-9]{1}[0-9]*

**element Riepilogo\_Redditi\_Type/ImponibileCedolareOrdinario**

diagram	 m730:ImponibileCedolareOrdina...
namespace	urn:www.agenziaentrate.gov.it:specificheTecniche:sco:730
type	<a href="#">DatoNP_Type</a>
facets	Kind Value pattern [1-9]{1}[0-9]*

**element Riepilogo\_Redditi\_Type/ImponibileCedolareAgevolato**

diagram	 m730:ImponibileCedolareAgevo...
namespace	urn:www.agenziaentrate.gov.it:specificheTecniche:sco:730
type	<a href="#">DatoNP_Type</a>
facets	Kind Value pattern [1-9]{1}[0-9]*

**element Riepilogo\_Redditi\_Type/AbitazionePrincipalePertinenze**

diagram	 m730:AbitazionePrincipalePertin...
namespace	urn:www.agenziaentrate.gov.it:specificheTecniche:sco:730
type	<a href="#">DatoNP_Type</a>
facets	Kind Value pattern [1-9]{1}[0-9]*

complexType **Ritenute\_Acconti\_Sospesi\_Type**

diagram	
namespace	urn:www.agenziaentrate.gov.it:specificheTecniche:sco:730
children	<a href="#">m730:CodiceEvento</a> <a href="#">m730:lrpef</a> <a href="#">m730:AddRegionalelrpef</a> <a href="#">m730:AddComunalelrpef</a> <a href="#">m730:SostitutivaPremi</a> <a href="#">m730:CedolareSecca</a>

element **Ritenute\_Acconti\_Sospesi\_Type/CodiceEvento**

diagram																					
namespace	urn:www.agenziaentrate.gov.it:specificheTecniche:sco:730																				
type	<a href="#">m730:Codice Evento Eccezionale Type</a>																				
facets	<table border="1"> <thead> <tr> <th>Kind</th> <th>Value</th> </tr> </thead> <tbody> <tr> <td>pattern</td> <td>[1-9]{1}[0-9]*</td> </tr> <tr> <td>enumeration</td> <td>1</td> </tr> <tr> <td>enumeration</td> <td>2</td> </tr> <tr> <td>enumeration</td> <td>3</td> </tr> <tr> <td>enumeration</td> <td>4</td> </tr> <tr> <td>enumeration</td> <td>5</td> </tr> <tr> <td>enumeration</td> <td>6</td> </tr> <tr> <td>enumeration</td> <td>7</td> </tr> <tr> <td>enumeration</td> <td>8</td> </tr> </tbody> </table>	Kind	Value	pattern	[1-9]{1}[0-9]*	enumeration	1	enumeration	2	enumeration	3	enumeration	4	enumeration	5	enumeration	6	enumeration	7	enumeration	8
Kind	Value																				
pattern	[1-9]{1}[0-9]*																				
enumeration	1																				
enumeration	2																				
enumeration	3																				
enumeration	4																				
enumeration	5																				
enumeration	6																				
enumeration	7																				
enumeration	8																				

element **Ritenute\_Acconti\_Sospesi\_Type/lrpef**

diagram					
namespace	urn:www.agenziaentrate.gov.it:specificheTecniche:sco:730				
type	<a href="#">DatoNP Type</a>				
facets	<table border="1"> <thead> <tr> <th>Kind</th> <th>Value</th> </tr> </thead> <tbody> <tr> <td>pattern</td> <td>[1-9]{1}[0-9]*</td> </tr> </tbody> </table>	Kind	Value	pattern	[1-9]{1}[0-9]*
Kind	Value				
pattern	[1-9]{1}[0-9]*				

element **Ritenute\_Acconti\_Sospesi\_Type/AddRegionalelrpef**

diagram	
---------	--

namespace	urn:www.agenziaentrate.gov.it:specificheTecniche:sco:730
type	<a href="#">DatoNP_Type</a>
facets	Kind Value pattern [1-9]{1}[0-9]*

**element Ritenute\_Acconti\_Sospesi\_Type/AddComunalelrpef**

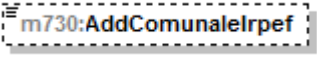
diagram	
namespace	urn:www.agenziaentrate.gov.it:specificheTecniche:sco:730
type	<a href="#">DatoNP_Type</a>
facets	Kind Value pattern [1-9]{1}[0-9]*

**element Ritenute\_Acconti\_Sospesi\_Type/SostitutivaPremi**

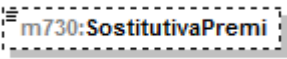
diagram	
namespace	urn:www.agenziaentrate.gov.it:specificheTecniche:sco:730
type	<a href="#">DatoNP_Type</a>
facets	Kind Value pattern [1-9]{1}[0-9]*

**element Ritenute\_Acconti\_Sospesi\_Type/CedolareSecca**

diagram	
namespace	urn:www.agenziaentrate.gov.it:specificheTecniche:sco:730
type	<a href="#">DatoNP_Type</a>
facets	Kind Value pattern [1-9]{1}[0-9]*

**complexType Ritenute\_Lavoro\_Dip\_Type**

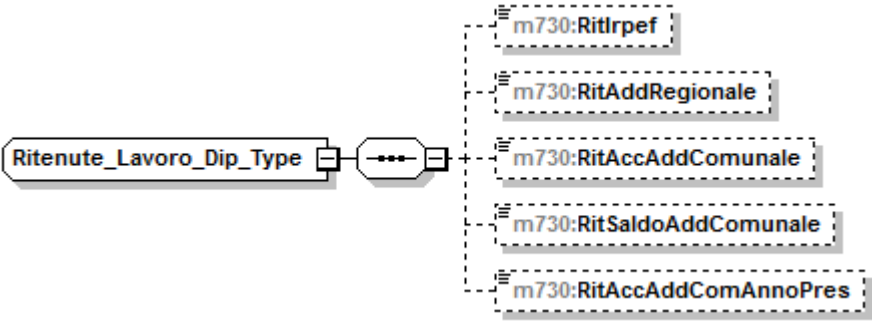
diagram	
namespace	urn:www.agenziaentrate.gov.it:specificheTecniche:sco:730



children	<a href="#">m730:Ritlrpef</a> <a href="#">m730:RitAddRegionale</a> <a href="#">m730:RitAccAddComunale</a> <a href="#">m730:RitSaldoAddComunale</a> <a href="#">m730:RitAccAddComAnnoPres</a>
----------	---

#### element Ritenute\_Lavoro\_Dip\_Type/Ritlrpef

diagram	
namespace	urn:www.agenziaentrategov.it:specificheTecniche:sco:730
type	<a href="#">DatoNP_Type</a>
facets	Kind Value pattern [1-9]{1}[0-9]*

#### element Ritenute\_Lavoro\_Dip\_Type/RitAddRegionale

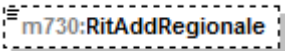
diagram	
namespace	urn:www.agenziaentrategov.it:specificheTecniche:sco:730
type	<a href="#">DatoNP_Type</a>
facets	Kind Value pattern [1-9]{1}[0-9]*

#### element Ritenute\_Lavoro\_Dip\_Type/RitAccAddComunale

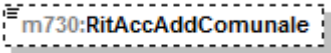
diagram	
namespace	urn:www.agenziaentrategov.it:specificheTecniche:sco:730
type	<a href="#">DatoNP_Type</a>
facets	Kind Value pattern [1-9]{1}[0-9]*

#### element Ritenute\_Lavoro\_Dip\_Type/RitSaldoAddComunale

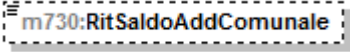
diagram	
namespace	urn:www.agenziaentrategov.it:specificheTecniche:sco:730
type	<a href="#">DatoNP_Type</a>
facets	Kind Value pattern [1-9]{1}[0-9]*

#### element Ritenute\_Lavoro\_Dip\_Type/RitAccAddComAnnoPres

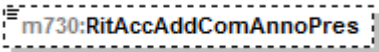
diagram	
namespace	urn:www.agenziaentrategov.it:specificheTecniche:sco:730

type	<a href="#">DatoNP_Type</a>				
facets	<table border="1"> <tr> <td>Kind</td> <td>Value</td> </tr> <tr> <td>pattern</td> <td>[1-9]{1}[0-9]*</td> </tr> </table>	Kind	Value	pattern	[1-9]{1}[0-9]*
Kind	Value				
pattern	[1-9]{1}[0-9]*				

### complexType **Sezione\_Altri\_Redd\_Type**

diagram	
namespace	urn:www.agenziaentrate.gov.it:specificheTecniche:sco:730
children	<a href="#">m730:TipoReddito</a> <a href="#">m730:RedditiRitenute</a>

### element **Sezione\_Altri\_Redd\_Type/TipoReddito**

diagram																					
namespace	urn:www.agenziaentrate.gov.it:specificheTecniche:sco:730																				
type	<a href="#">m730:Tipo_Reddito_Da1a8_Type</a>																				
facets	<table border="1"> <tr> <td>Kind</td> <td>Value</td> </tr> <tr> <td>pattern</td> <td>[1-9]{1}[0-9]*</td> </tr> <tr> <td>enumeration</td> <td>1</td> </tr> <tr> <td>enumeration</td> <td>2</td> </tr> <tr> <td>enumeration</td> <td>3</td> </tr> <tr> <td>enumeration</td> <td>4</td> </tr> <tr> <td>enumeration</td> <td>5</td> </tr> <tr> <td>enumeration</td> <td>6</td> </tr> <tr> <td>enumeration</td> <td>7</td> </tr> <tr> <td>enumeration</td> <td>8</td> </tr> </table>	Kind	Value	pattern	[1-9]{1}[0-9]*	enumeration	1	enumeration	2	enumeration	3	enumeration	4	enumeration	5	enumeration	6	enumeration	7	enumeration	8
Kind	Value																				
pattern	[1-9]{1}[0-9]*																				
enumeration	1																				
enumeration	2																				
enumeration	3																				
enumeration	4																				
enumeration	5																				
enumeration	6																				
enumeration	7																				
enumeration	8																				

### element **Sezione\_Altri\_Redd\_Type/RedditiRitenute**

diagram	
namespace	urn:www.agenziaentrate.gov.it:specificheTecniche:sco:730
type	<a href="#">m730:Redditi_Ritenute_Type</a>
children	<a href="#">m730:ImportoRedditi</a> <a href="#">m730:ImportoRitenute</a>

complexType **Sezione\_Dati\_Catastali\_Recupero\_Patrimonio\_Edilizio\_Type**

diagram	
namespace	urn:www.agenziaentrate.gov.it:specificheTecniche:sco:730
children	<a href="#">m730:DatiCatastaliRecuperoPatrimonioEdilizio</a> <a href="#">m730:DatiRegistrazioneAccatastamentoRecuperoPatrimonio_Edilizio</a>

element

**Sezione\_Dati\_Catastali\_Recupero\_Patrimonio\_Edilizio\_Type/DatiCatastaliRecuperoPatrimonioEdilizio**

diagram	
namespace	urn:www.agenziaentrate.gov.it:specificheTecniche:sco:730
type	extension of <a href="#">m730:Dati_Catastali_Recupero_Patrimonio_Edilizio_Type</a>
children	<a href="#">m730:NOrdImmobile</a> <a href="#">m730:Condominio</a> <a href="#">m730:DatiCatastali</a>

element

**Sezione\_Dati\_Catastali\_Recupero\_Patrimonio\_Edilizio\_Type/DatiRegistrazioneAccatastamentoRecuperoPatrimonio\_Edilizio**

diagram	
namespace	urn:www.agenziaentrate.gov.it:specificheTecniche:sco:730
type	<a href="#">m730:Dati_Registrazione_Accatastamento_Recupero_Patrimonio_Edilizio_Type</a>
children	<a href="#">m730:NOrdImmobile</a> <a href="#">m730:Condominio</a> <a href="#">m730:EstremiRegistrazioneContratto</a> <a href="#">m730:DomandaAccatastamento</a>

complexType **Soggetto\_Assistenza\_Fiscale\_Doc\_Type**

diagram	
namespace	urn:www.agenziaentrate.gov.it:specificheTecniche:sco:730
children	<a href="#">m730:DataConsegna</a> <a href="#">m730:TipologiaSoggettoAssFisc</a> <a href="#">m730:SostitutoCF</a> <a href="#">m730:DatiCafDoc</a> <a href="#">m730:DatiProfessionistaDoc</a> <a href="#">m730:DatiAssociazioneDoc</a> <a href="#">m730:AgenziaEntrate</a>

element **Soggetto\_Assistenza\_Fiscale\_Doc\_Type/DataConsegna**

diagram					
namespace	urn:www.agenziaentrate.gov.it:specificheTecniche:sco:730				
type	<a href="#">DatoDT_Type</a>				
facets	<table border="1"> <thead> <tr> <th>Kind</th> <th>Value</th> </tr> </thead> <tbody> <tr> <td>pattern</td> <td>((([0-9]{1,12}[0-9]{3,10})(0[13578]1012\d{4})) ((([0-9]{1,12}[0-9]{30}0[469]11\d{4})) ((([0-9]{1,12}[0-9]{20-8})(02\d{4})) ((29)(02)[02468]04800)) ((29)(02)[13579]2600)) ((29)(02)[0-9]0[0148]) ((29)(02)[0-9]0-9[2468]048)) ((29)(02)[0-9]13579]26)))</td> </tr> </tbody> </table>	Kind	Value	pattern	((([0-9]{1,12}[0-9]{3,10})(0[13578]1012\d{4})) ((([0-9]{1,12}[0-9]{30}0[469]11\d{4})) ((([0-9]{1,12}[0-9]{20-8})(02\d{4})) ((29)(02)[02468]04800)) ((29)(02)[13579]2600)) ((29)(02)[0-9]0[0148]) ((29)(02)[0-9]0-9[2468]048)) ((29)(02)[0-9]13579]26)))
Kind	Value				
pattern	((([0-9]{1,12}[0-9]{3,10})(0[13578]1012\d{4})) ((([0-9]{1,12}[0-9]{30}0[469]11\d{4})) ((([0-9]{1,12}[0-9]{20-8})(02\d{4})) ((29)(02)[02468]04800)) ((29)(02)[13579]2600)) ((29)(02)[0-9]0[0148]) ((29)(02)[0-9]0-9[2468]048)) ((29)(02)[0-9]13579]26)))				

element **Soggetto\_Assistenza\_Fiscale\_Doc\_Type/TipologiaSoggettoAssFisc**

diagram															
namespace	urn:www.agenziaentrate.gov.it:specificheTecniche:sco:730														
type	<a href="#">m730:Tipologia_Soggetto_Ass_Fisc_Type</a>														
facets	<table border="1"> <thead> <tr> <th>Kind</th> <th>Value</th> </tr> </thead> <tbody> <tr> <td>pattern</td> <td>[1-9]</td> </tr> <tr> <td>enumeration</td> <td>1</td> </tr> <tr> <td>enumeration</td> <td>2</td> </tr> <tr> <td>enumeration</td> <td>3</td> </tr> <tr> <td>enumeration</td> <td>4</td> </tr> <tr> <td>enumeration</td> <td>5</td> </tr> </tbody> </table>	Kind	Value	pattern	[1-9]	enumeration	1	enumeration	2	enumeration	3	enumeration	4	enumeration	5
Kind	Value														
pattern	[1-9]														
enumeration	1														
enumeration	2														
enumeration	3														
enumeration	4														
enumeration	5														

element **Soggetto\_Assistenza\_Fiscale\_Doc\_Type/SostitutoCF**

diagram	
---------	--

namespace	urn:www.agenziaentrate.gov.it:specificheTecniche:sco:730	
type	<a href="#">DatoCF_Type</a>	
facets	Kind	Value
	pattern	[0-9]{11}[A-Z]{6}[0-9LMNPQRSTU]{2}[A-Z]{1}[0-9LMNPQRSTU]{2}[A-Z]{1}[0-9LMNPQRSTU]{3}[A-Z]{1}

element **Soggetto\_Assistenza\_Fiscale\_Doc\_Type/DatiCafDoc**

diagram		
namespace	urn:www.agenziaentrate.gov.it:specificheTecniche:sco:730	
type	extension of <a href="#">m730:Dati_CAF_Type</a>	
children	<a href="#">m730:CFCaf</a> <a href="#">m730:DenominazioneCaf</a> <a href="#">m730:NumeroAlbo</a> <a href="#">m730:CFResponsabile</a> <a href="#">m730:CognomeResponsabile</a> <a href="#">m730:NomeResponsabile</a> <a href="#">m730:CF Soc Servizi</a> <a href="#">m730:Id Sede Periferica</a> <a href="#">m730:Casella Attestazione Caf</a>	

element **Soggetto\_Assistenza\_Fiscale\_Doc\_Type/DatiCafDoc/CFResponsabile**

diagram		
namespace	urn:www.agenziaentrate.gov.it:specificheTecniche:sco:730	
type	<a href="#">DatoCF_Type</a>	
facets	Kind	Value
	pattern	[0-9]{11}[A-Z]{6}[0-9LMNPQRSTU]{2}[A-Z]{1}[0-9LMNPQRSTU]{2}[A-Z]{1}[0-9LMNPQRSTU]{3}[A-Z]{1}

element **Soggetto\_Assistenza\_Fiscale\_Doc\_Type/DatiCafDoc/CognomeResponsabile**

diagram		
---------	--	--

namespace	urn:www.agenziaentrate.gov.it:specificheTecniche:sco:730
type	<a href="#">DatoAN_Type</a>
facets	Kind Value pattern ([0-9A-Z\-\&quot;]{1})([ 0-9A-Z&amp;:] ' \"- \". , / ° \"^\\(\\) À É È Ì Ò Ù Û &quot; \\\" \\+)*

element **Soggetto\_Assistenza\_Fiscale\_Doc\_Type/DatiCafDoc/NomeResponsabile**

diagram	
namespace	urn:www.agenziaentrate.gov.it:specificheTecniche:sco:730
type	<a href="#">DatoAN_Type</a>
facets	Kind Value pattern ([0-9A-Z\-\&quot;]{1})([ 0-9A-Z&amp;:] ' \"- \". , / ° \"^\\(\\) À É È Ì Ò Ù Û &quot; \\\" \\+)*

element **Soggetto\_Assistenza\_Fiscale\_Doc\_Type/DatiCafDoc/CF Soc Servizi**

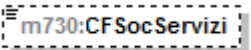
diagram	
namespace	urn:www.agenziaentrate.gov.it:specificheTecniche:sco:730
type	<a href="#">DatoCN_Type</a>
facets	Kind Value pattern [0-9]{11}

element **Soggetto\_Assistenza\_Fiscale\_Doc\_Type/DatiCafDoc/IdSedePeriferica**

diagram	
namespace	urn:www.agenziaentrate.gov.it:specificheTecniche:sco:730
type	<a href="#">DatoAN_Type</a>
facets	Kind Value pattern ([0-9A-Z\-\&quot;]{1})([ 0-9A-Z&amp;:] ' \"- \". , / ° \"^\\(\\) À É È Ì Ò Ù Û &quot; \\\" \\+)*

element **Soggetto\_Assistenza\_Fiscale\_Doc\_Type/DatiCafDoc/CasellaAttestazioneCaf**

diagram	
namespace	urn:www.agenziaentrate.gov.it:specificheTecniche:sco:730
type	<a href="#">DatoCB_Type</a>
facets	Kind Value pattern [01]

element **Soggetto\_Assistenza\_Fiscale\_Doc\_Type/DatiProfessionistaDoc**

diagram	
namespace	urn:www.agenziaentrate.gov.it:specificheTecniche:sco:730
type	extension of <a href="#">m730:Dati Professionista Type</a>
children	<a href="#">m730:CFProfessionista</a> <a href="#">m730:CognomeProfessionista</a> <a href="#">m730:NomeProfessionista</a> <a href="#">m730:DatiNascitaProfessionista</a>

element **Soggetto\_Assistenza\_Fiscale\_Doc\_Type/DatiProfessionistaDoc/DatiNascitaProfessionista**

diagram	
namespace	urn:www.agenziaentrate.gov.it:specificheTecniche:sco:730
type	<a href="#">m730:Dati_Nascita_PF_Type</a>
children	<a href="#">m730:Sesso</a> <a href="#">m730:DataNascita</a> <a href="#">m730:ComuneNascita</a> <a href="#">m730:ProvinciaNascita</a>

element **Soggetto\_Assistenza\_Fiscale\_Doc\_Type/DatiAssociazioneDoc**

diagram	
namespace	urn:www.agenziaentrate.gov.it:specificheTecniche:sco:730
type	extension of <a href="#">m730:Dati_Associazioni_Professionale_Type</a>
children	<a href="#">m730:CFAssociazione</a> <a href="#">m730:DenominazioneAssociazione</a> <a href="#">m730:CFProfessionista</a> <a href="#">m730:CognomeProfessionista</a> <a href="#">m730:NomeProfessionista</a> <a href="#">m730:DatiNascitaProfessionista</a>

element **Soggetto\_Assistenza\_Fiscale\_Doc\_Type/DatiAssociazioneDoc/DatiNascitaProfessionista**

diagram	
namespace	urn:www.agenziaentrate.gov.it:specificheTecniche:sco:730
type	<a href="#">m730:Dati_Nascita_PF_Type</a>
children	<a href="#">m730:Sesso</a> <a href="#">m730:DataNascita</a> <a href="#">m730:ComuneNascita</a> <a href="#">m730:ProvinciaNascita</a>

element **Soggetto\_Assistenza\_Fiscale\_Doc\_Type/AgenziaEntrate**

diagram					
namespace	urn:www.agenziaentrate.gov.it:specificheTecniche:sco:730				
type	<a href="#">DatoCB_Type</a>				
facets	<table border="1"> <thead> <tr> <th>Kind</th> <th>Value</th> </tr> </thead> <tbody> <tr> <td>pattern</td> <td>[01]</td> </tr> </tbody> </table>	Kind	Value	pattern	[01]
Kind	Value				
pattern	[01]				



complexType **Soggetto\_Fiscale\_730\_Type**

diagram	
namespace	urn:www.agenziaentrate.gov.it:specificheTecniche:sco:730
children	<a href="#">m730:CodiceFiscale</a> <a href="#">m730:Email</a> <a href="#">m730:Telefono</a> <a href="#">m730:Cellulare</a>

element **Soggetto\_Fiscale\_730\_Type/CodiceFiscale**

diagram					
namespace	urn:www.agenziaentrate.gov.it:specificheTecniche:sco:730				
type	<a href="#">DatoCF_Type</a>				
facets	<table border="1"> <thead> <tr> <th>Kind</th> <th>Value</th> </tr> </thead> <tbody> <tr> <td>pattern</td> <td>[0-9]{11}[A-Z]{6}[0-9LMNPQRSTU]{2}[A-Z]{1}[0-9LMNPQRSTU]{2}[A-Z]{1}[0-9LMNPQRSTU]{3}[A-Z]{1}</td> </tr> </tbody> </table>	Kind	Value	pattern	[0-9]{11}[A-Z]{6}[0-9LMNPQRSTU]{2}[A-Z]{1}[0-9LMNPQRSTU]{2}[A-Z]{1}[0-9LMNPQRSTU]{3}[A-Z]{1}
Kind	Value				
pattern	[0-9]{11}[A-Z]{6}[0-9LMNPQRSTU]{2}[A-Z]{1}[0-9LMNPQRSTU]{2}[A-Z]{1}[0-9LMNPQRSTU]{3}[A-Z]{1}				

element **Soggetto\_Fiscale\_730\_Type/Email**

diagram					
namespace	urn:www.agenziaentrate.gov.it:specificheTecniche:sco:730				
type	<a href="#">DatoEM_Type</a>				
facets	<table border="1"> <thead> <tr> <th>Kind</th> <th>Value</th> </tr> </thead> <tbody> <tr> <td>pattern</td> <td>[a-zA-Z0-9._%'\- &amp;quot;?^~=]+@[a-zA-Z0-9.\-]+\.[a-zA-Z]{2,4}</td> </tr> </tbody> </table>	Kind	Value	pattern	[a-zA-Z0-9._%'\- &quot;?^~=]+@[a-zA-Z0-9.\-]+\.[a-zA-Z]{2,4}
Kind	Value				
pattern	[a-zA-Z0-9._%'\- &quot;?^~=]+@[a-zA-Z0-9.\-]+\.[a-zA-Z]{2,4}				

element **Soggetto\_Fiscale\_730\_Type/Telefono**

diagram					
namespace	urn:www.agenziaentrate.gov.it:specificheTecniche:sco:730				
type	<a href="#">DatoAN_Type</a>				
facets	<table border="1"> <thead> <tr> <th>Kind</th> <th>Value</th> </tr> </thead> <tbody> <tr> <td>pattern</td> <td>(([0-9A-Z-])&amp;quot;){1}([0-9A-Z&amp;amp;#39;] - \., / ° ^\(\\( \) À È É Ì Ò Ù Û &amp;quot; \\ \\+)*</td> </tr> </tbody> </table>	Kind	Value	pattern	(([0-9A-Z-])&quot;){1}([0-9A-Z&amp;#39;] - \., / ° ^\(\\( \) À È É Ì Ò Ù Û &quot; \\ \\+)*
Kind	Value				
pattern	(([0-9A-Z-])&quot;){1}([0-9A-Z&amp;#39;] - \., / ° ^\(\\( \) À È É Ì Ò Ù Û &quot; \\ \\+)*				

element **Soggetto\_Fiscale\_730\_Type/Cellulare**

diagram					
namespace	urn:www.agenziaentrate.gov.it:specificheTecniche:sco:730				
type	<a href="#">DatoAN_Type</a>				
facets	<table border="1"> <thead> <tr> <th>Kind</th> <th>Value</th> </tr> </thead> <tbody> <tr> <td>pattern</td> <td>(([0-9A-Z-] \&amp;quot;){1}([ 0-9A-Z&amp;amp;:] [-\., / ^\(\)\] À É È Ì Ò Ù Ü &amp;quot; \ \\ / +)*</td> </tr> </tbody> </table>	Kind	Value	pattern	(([0-9A-Z-] \&quot;){1}([ 0-9A-Z&amp;:] [-\., / ^\(\)\] À É È Ì Ò Ù Ü &quot; \ \\ / +)*
Kind	Value				
pattern	(([0-9A-Z-] \&quot;){1}([ 0-9A-Z&amp;:] [-\., / ^\(\)\] À É È Ì Ò Ù Ü &quot; \ \\ / +)*				

complexType **Soglie\_Esenzione\_Type**

diagram	
namespace	urn:www.agenziaentrate.gov.it:specificheTecniche:sco:730
children	<a href="#">m730:SogliaEsenzione</a> <a href="#">m730:EsenzioneTotale</a>

element **Soglie\_Esenzione\_Type/SogliaEsenzione**

diagram					
namespace	urn:www.agenziaentrate.gov.it:specificheTecniche:sco:730				
type	<a href="#">DatoNP_Type</a>				
facets	<table border="1"> <thead> <tr> <th>Kind</th> <th>Value</th> </tr> </thead> <tbody> <tr> <td>pattern</td> <td>[1-9]{1}[0-9]*</td> </tr> </tbody> </table>	Kind	Value	pattern	[1-9]{1}[0-9]*
Kind	Value				
pattern	[1-9]{1}[0-9]*				

element **Soglie\_Esenzione\_Type/EsenzioneTotale**

diagram									
namespace	urn:www.agenziaentrate.gov.it:specificheTecniche:sco:730								
type	restriction of <a href="#">DatoN1_Type</a>								
facets	<table border="1"> <thead> <tr> <th>Kind</th> <th>Value</th> </tr> </thead> <tbody> <tr> <td>pattern</td> <td>[1-9]</td> </tr> <tr> <td>enumeration</td> <td>1</td> </tr> <tr> <td>enumeration</td> <td>2</td> </tr> </tbody> </table>	Kind	Value	pattern	[1-9]	enumeration	1	enumeration	2
Kind	Value								
pattern	[1-9]								
enumeration	1								
enumeration	2								

### complexType **Sostituto\_Type**

diagram	
namespace	urn:www.agenziaentrate.gov.it:specificheTecniche:sco:730
children	<a href="#">m730:CodiceFiscale</a> <a href="#">m730:DatiAnagraficiPF</a> <a href="#">m730:DenominazionePNF</a> <a href="#">m730:Residenza</a> <a href="#">m730:Fax</a> <a href="#">m730:CodiceSede</a>

### element **Sostituto\_Type/CodiceFiscale**

diagram					
namespace	urn:www.agenziaentrate.gov.it:specificheTecniche:sco:730				
type	<a href="#">DatoCF_Type</a>				
facets	<table border="1"> <thead> <tr> <th>Kind</th> <th>Value</th> </tr> </thead> <tbody> <tr> <td>pattern</td> <td>[0-9]{11}[A-Z]{6}[0-9LMNPQRSTU]{2}[A-Z]{1}[0-9LMNPQRSTU]{2}[A-Z]{1}[0-9LMNPQRSTU]{3}[A-Z]{1}</td> </tr> </tbody> </table>	Kind	Value	pattern	[0-9]{11}[A-Z]{6}[0-9LMNPQRSTU]{2}[A-Z]{1}[0-9LMNPQRSTU]{2}[A-Z]{1}[0-9LMNPQRSTU]{3}[A-Z]{1}
Kind	Value				
pattern	[0-9]{11}[A-Z]{6}[0-9LMNPQRSTU]{2}[A-Z]{1}[0-9LMNPQRSTU]{2}[A-Z]{1}[0-9LMNPQRSTU]{3}[A-Z]{1}				

### element **Sostituto\_Type/DatiAnagraficiPF**

diagram	
namespace	urn:www.agenziaentrate.gov.it:specificheTecniche:sco:730
children	<a href="#">m730:Cognome</a> <a href="#">m730:Nome</a>

### element **Sostituto\_Type/DatiAnagraficiPF/Cognome**

diagram					
namespace	urn:www.agenziaentrate.gov.it:specificheTecniche:sco:730				
type	<a href="#">DatoAN_Type</a>				
facets	<table border="1"> <thead> <tr> <th>Kind</th> <th>Value</th> </tr> </thead> <tbody> <tr> <td>pattern</td> <td>(([0-9A-Z-]*)&amp;quot;){1}([ 0-9A-Z&amp;amp;:] ' - \., / ° ^\(\ \) À É É Ì Ò Ù Û &amp;quot; \ \\ +)*</td> </tr> </tbody> </table>	Kind	Value	pattern	(([0-9A-Z-]*)&quot;){1}([ 0-9A-Z&amp;:] ' - \., / ° ^\(\ \) À É É Ì Ò Ù Û &quot; \ \\ +)*
Kind	Value				
pattern	(([0-9A-Z-]*)&quot;){1}([ 0-9A-Z&amp;:] ' - \., / ° ^\(\ \) À É É Ì Ò Ù Û &quot; \ \\ +)*				

element **Sostituto\_Type/DatiAnagraficiPF/Nome**

diagram	
namespace	urn:www.agenziaentrate.gov.it:specificheTecniche:sco:730
type	<a href="#">DatoAN_Type</a>
facets	Kind Value pattern ([0-9A-Z-] \&quot;){1}([ 0-9A-Z&amp;] '\- \., / \^\(\ \)\À É È Ì Ò Ù Û &quot; \ \\ \ +)*

element **Sostituto\_Type/DenominazionePNF**

diagram	
namespace	urn:www.agenziaentrate.gov.it:specificheTecniche:sco:730
type	<a href="#">DatoAN_Type</a>
facets	Kind Value pattern ([0-9A-Z-] \&quot;){1}([ 0-9A-Z&amp;] '\- \., / \^\(\ \)\À É È Ì Ò Ù Û &quot; \ \\ \ +)*

element **Sostituto\_Type/Residenza**

diagram	
namespace	urn:www.agenziaentrate.gov.it:specificheTecniche:sco:730
type	<a href="#">m730:Residenza_Type</a>
children	<a href="#">m730:Comune</a> <a href="#">m730:Provincia</a> <a href="#">m730:CodiceComune</a> <a href="#">m730:Cap</a> <a href="#">m730:Tipologia</a> <a href="#">m730:Indirizzo</a> <a href="#">m730:NumCivico</a> <a href="#">m730:Frazione</a> <a href="#">m730:Email</a> <a href="#">m730:Telefono</a>

element **Sostituto\_Type/Fax**

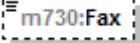
diagram	
namespace	urn:www.agenziaentrate.gov.it:specificheTecniche:sco:730
type	<a href="#">DatoAN_Type</a>
facets	Kind Value pattern ([0-9A-Z\-\-]&quot;){1}([ 0-9A-Z&amp;:] ' \- \., / ^ \^\(\\) À É È Ì Ò Ù Û &quot; \\ /+)*

element **Sostituto\_Type/CodiceSede**

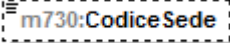
diagram	
namespace	urn:www.agenziaentrate.gov.it:specificheTecniche:sco:730
type	<a href="#">DatoAN_Type</a>
facets	Kind Value pattern ([0-9A-Z\-\-]&quot;){1}([ 0-9A-Z&amp;:] ' \- \., / ^ \^\(\\) À É È Ì Ò Ù Û &quot; \\ /+)*

complexType **Spese\_Arredo\_Giovani\_Coppie\_Type**

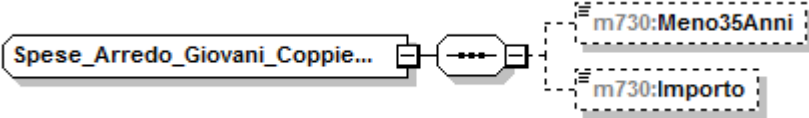
diagram	
namespace	urn:www.agenziaentrate.gov.it:specificheTecniche:sco:730
children	<a href="#">m730:Meno35Anni</a> <a href="#">m730:Importo</a>

element **Spese\_Arredo\_Giovani\_Coppie\_Type/Meno35Anni**

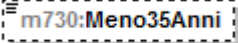
diagram	
namespace	urn:www.agenziaentrate.gov.it:specificheTecniche:sco:730
type	<a href="#">DatoCB_Type</a>
facets	Kind Value pattern [01]

element **Spese\_Arredo\_Giovani\_Coppie\_Type/Importo**

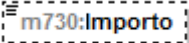
diagram	
namespace	urn:www.agenziaentrate.gov.it:specificheTecniche:sco:730
type	<a href="#">DatoNP_Type</a>
facets	Kind Value pattern [1-9]{1}[0-9]*

complexType **Spese\_Arredo\_Type**

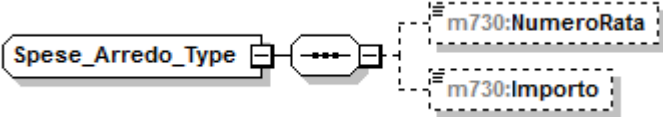
diagram	
namespace	urn:www.agenziaentrate.gov.it:specificheTecniche:sco:730
children	<a href="#">m730:NumeroRata</a> <a href="#">m730:Importo</a>

element **Spese\_Arredo\_Type/NumeroRata**

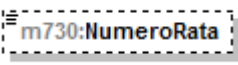
diagram															
namespace	urn:www.agenziaentrate.gov.it:specificheTecniche:sco:730														
type	restriction of <a href="#">DatoNP_Type</a>														
facets	<table border="1"> <thead> <tr> <th>Kind</th> <th>Value</th> </tr> </thead> <tbody> <tr> <td>pattern</td> <td>[1-9]{1}[0-9]*</td> </tr> <tr> <td>enumeration</td> <td>1</td> </tr> <tr> <td>enumeration</td> <td>2</td> </tr> <tr> <td>enumeration</td> <td>3</td> </tr> <tr> <td>enumeration</td> <td>4</td> </tr> <tr> <td>enumeration</td> <td>5</td> </tr> </tbody> </table>	Kind	Value	pattern	[1-9]{1}[0-9]*	enumeration	1	enumeration	2	enumeration	3	enumeration	4	enumeration	5
Kind	Value														
pattern	[1-9]{1}[0-9]*														
enumeration	1														
enumeration	2														
enumeration	3														
enumeration	4														
enumeration	5														

element **Spese\_Arredo\_Type/Importo**

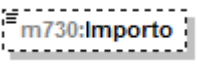
diagram					
namespace	urn:www.agenziaentrate.gov.it:specificheTecniche:sco:730				
type	<a href="#">DatoNP_Type</a>				
facets	<table border="1"> <thead> <tr> <th>Kind</th> <th>Value</th> </tr> </thead> <tbody> <tr> <td>pattern</td> <td>[1-9]{1}[0-9]*</td> </tr> </tbody> </table>	Kind	Value	pattern	[1-9]{1}[0-9]*
Kind	Value				
pattern	[1-9]{1}[0-9]*				

complexType **Spese\_Leasing\_Type**

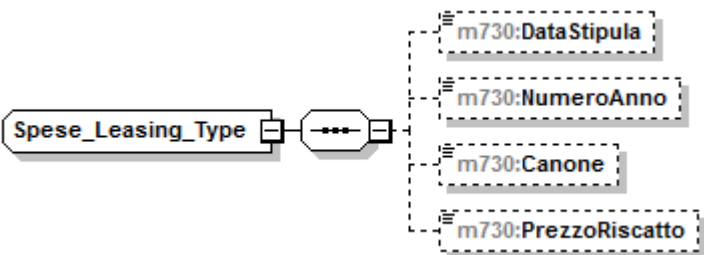
diagram	
namespace	urn:www.agenziaentrate.gov.it:specificheTecniche:sco:730
children	<a href="#">m730:DataStipula</a> <a href="#">m730:NumeroAnno</a> <a href="#">m730:Canone</a> <a href="#">m730:PrezzoRiscatto</a>

element **Spese\_Leasing\_Type/DataStipula**

diagram					
namespace	urn:www.agenziaentrate.gov.it:specificheTecniche:sco:730				
type	<a href="#">DatoDT_Type</a>				
facets	<table border="1"> <thead> <tr> <th>Kind</th> <th>Value</th> </tr> </thead> <tbody> <tr> <td>pattern</td> <td>((([0-9]{1,2}[0-9]{3,4}) (0[13578][1012]\d{4})) (((0[1-9][12][0-9]{30})(0[469][11]\d{4})) ((0[1-9][10-9][20-8])(02\d{4})) ((29)(02)([02468][048]00)) ((29)(02)([13579][26]00)) ((29)(02)([0-9][0][48])) ((29)(02)([0-9][0-9][2468][048])) ((29)(02)([0-9][13579][26]))))</td> </tr> </tbody> </table>	Kind	Value	pattern	((([0-9]{1,2}[0-9]{3,4}) (0[13578][1012]\d{4})) (((0[1-9][12][0-9]{30})(0[469][11]\d{4})) ((0[1-9][10-9][20-8])(02\d{4})) ((29)(02)([02468][048]00)) ((29)(02)([13579][26]00)) ((29)(02)([0-9][0][48])) ((29)(02)([0-9][0-9][2468][048])) ((29)(02)([0-9][13579][26]))))
Kind	Value				
pattern	((([0-9]{1,2}[0-9]{3,4}) (0[13578][1012]\d{4})) (((0[1-9][12][0-9]{30})(0[469][11]\d{4})) ((0[1-9][10-9][20-8])(02\d{4})) ((29)(02)([02468][048]00)) ((29)(02)([13579][26]00)) ((29)(02)([0-9][0][48])) ((29)(02)([0-9][0-9][2468][048])) ((29)(02)([0-9][13579][26]))))				

element **Spese\_Leasing\_Type/NumeroAnno**

diagram									
namespace	urn:www.agenziaentrate.gov.it:specificheTecniche:sco:730								
type	restriction of <a href="#">DatoNP_Type</a>								
facets	<table border="1"> <thead> <tr> <th>Kind</th> <th>Value</th> </tr> </thead> <tbody> <tr> <td>pattern</td> <td>[1-9]{1}[0-9]*</td> </tr> <tr> <td>enumeration</td> <td>1</td> </tr> <tr> <td>enumeration</td> <td>2</td> </tr> </tbody> </table>	Kind	Value	pattern	[1-9]{1}[0-9]*	enumeration	1	enumeration	2
Kind	Value								
pattern	[1-9]{1}[0-9]*								
enumeration	1								
enumeration	2								

element **Spese\_Leasing\_Type/Canone**

diagram					
namespace	urn:www.agenziaentrate.gov.it:specificheTecniche:sco:730				
type	restriction of <a href="#">DatoNP_Type</a>				
facets	<table border="1"> <thead> <tr> <th>Kind</th> <th>Value</th> </tr> </thead> <tbody> <tr> <td>pattern</td> <td>[1-9]{1}[0-9]*</td> </tr> </tbody> </table>	Kind	Value	pattern	[1-9]{1}[0-9]*
Kind	Value				
pattern	[1-9]{1}[0-9]*				

element **Spese\_Leasing\_Type/PrezzoRiscatto**

diagram					
namespace	urn:www.agenziaentrate.gov.it:specificheTecniche:sco:730				
type	restriction of <a href="#">DatoNP_Type</a>				
facets	<table border="1"> <thead> <tr> <th>Kind</th> <th>Value</th> </tr> </thead> <tbody> <tr> <td>pattern</td> <td>[1-9]{1}[0-9]*</td> </tr> </tbody> </table>	Kind	Value	pattern	[1-9]{1}[0-9]*
Kind	Value				
pattern	[1-9]{1}[0-9]*				

complexType **Spese\_Rateizzate\_Anni\_Precedenti\_Type**

diagram	
---------	--

namespace	urn:www.agenziaentrate.gov.it:specificheTecniche:sco:730
children	<a href="#">m730:Codice</a> <a href="#">m730:Importo</a>

element **Spese\_Rateizzate\_Anni\_Precedenti\_Type/Codice**

diagram											
namespace	urn:www.agenziaentrate.gov.it:specificheTecniche:sco:730										
type	<a href="#">m730:Codice Spese Rateizzate Anni Precedenti Type</a>										
facets	<table border="1"> <tr> <td>Kind</td> <td>Value</td> </tr> <tr> <td>pattern</td> <td>[1-9]{1}[0-9]*</td> </tr> <tr> <td>enumeration</td> <td>2</td> </tr> <tr> <td>enumeration</td> <td>3</td> </tr> <tr> <td>enumeration</td> <td>4</td> </tr> </table>	Kind	Value	pattern	[1-9]{1}[0-9]*	enumeration	2	enumeration	3	enumeration	4
Kind	Value										
pattern	[1-9]{1}[0-9]*										
enumeration	2										
enumeration	3										
enumeration	4										

element **Spese\_Rateizzate\_Anni\_Precedenti\_Type/Importo**

diagram					
namespace	urn:www.agenziaentrate.gov.it:specificheTecniche:sco:730				
type	<a href="#">DatoNP Type</a>				
facets	<table border="1"> <tr> <td>Kind</td> <td>Value</td> </tr> <tr> <td>pattern</td> <td>[1-9]{1}[0-9]*</td> </tr> </table>	Kind	Value	pattern	[1-9]{1}[0-9]*
Kind	Value				
pattern	[1-9]{1}[0-9]*				

complexType **Spese\_Rateizzate\_Type**

diagram	
namespace	urn:www.agenziaentrate.gov.it:specificheTecniche:sco:730
children	<a href="#">m730:Codice</a> <a href="#">m730:Importo</a>

element **Spese\_Rateizzate\_Type/Codice**

diagram													
namespace	urn:www.agenziaentrate.gov.it:specificheTecniche:sco:730												
type	<a href="#">m730:Codice Spese Rateizzate Type</a>												
facets	<table border="1"> <tr> <td>Kind</td> <td>Value</td> </tr> <tr> <td>pattern</td> <td>[1-9]{1}[0-9]*</td> </tr> <tr> <td>enumeration</td> <td>1</td> </tr> <tr> <td>enumeration</td> <td>2</td> </tr> <tr> <td>enumeration</td> <td>3</td> </tr> <tr> <td>enumeration</td> <td>4</td> </tr> </table>	Kind	Value	pattern	[1-9]{1}[0-9]*	enumeration	1	enumeration	2	enumeration	3	enumeration	4
Kind	Value												
pattern	[1-9]{1}[0-9]*												
enumeration	1												
enumeration	2												
enumeration	3												
enumeration	4												



**element Spese\_Rateizzate\_Type/Importo**

diagram	
namespace	urn:www.agenziaentrate.gov.it:specificheTecniche:sco:730
type	<a href="#">DatoNP_Type</a>
facets	Kind Value pattern [1-9]{1}[0-9]*

**complexType Tassazione\_Separata\_Type**

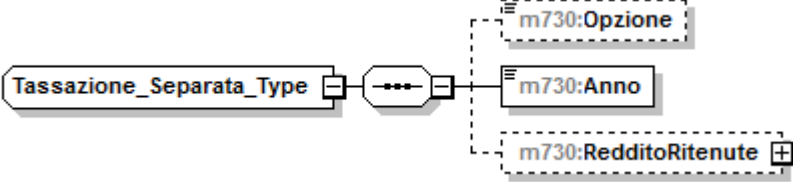
diagram	
namespace	urn:www.agenziaentrate.gov.it:specificheTecniche:sco:730
children	<a href="#">m730:Opzione</a> <a href="#">m730:Anno</a> <a href="#">m730:RedditoRitenute</a>

**element Tassazione\_Separata\_Type/Opzione**

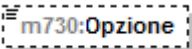
diagram	
namespace	urn:www.agenziaentrate.gov.it:specificheTecniche:sco:730
type	<a href="#">DatoCB_Type</a>
facets	Kind Value pattern [01]

**element Tassazione\_Separata\_Type/Anno**

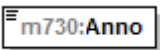
diagram	
namespace	urn:www.agenziaentrate.gov.it:specificheTecniche:sco:730
type	<a href="#">DatoDA_Type</a>
facets	Kind Value pattern (18 19 20)[0-9]{2}

element **Tassazione\_Separata\_Type/RedditoRitenute**

diagram	
namespace	urn:www.agenziaentrate.gov.it:specificheTecniche:sco:730
type	<a href="#">m730:Redditi_Ritenute_Type</a>
children	<a href="#">m730:ImportoRedditi</a> <a href="#">m730:ImportoRitenute</a>

complexType **Terreno\_Type**

diagram	
namespace	urn:www.agenziaentrate.gov.it:specificheTecniche:sco:730
children	<a href="#">m730:RedDominicale</a> <a href="#">m730:Titolo</a> <a href="#">m730:RedAgrario</a> <a href="#">m730:GiorniPossesso</a> <a href="#">m730:PercPossesso</a> <a href="#">m730:CanoneVincolistico</a> <a href="#">m730:CasiParticolari</a> <a href="#">m730:CasellaContinuazione</a> <a href="#">m730:CasellalmuNonDovuta</a> <a href="#">m730:CasellaColtivatoreDiretto</a>

element **Terreno\_Type/RedDominicale**

diagram	
namespace	urn:www.agenziaentrate.gov.it:specificheTecniche:sco:730
type	<a href="#">DatoNP_Type</a>
facets	Kind Value

pattern	[1-9]{1}[0-9]*
---------	----------------

### element Terreno\_Type/Titolo

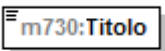
diagram																					
namespace	urn:www.agenziaentrate.gov.it:specificheTecniche:sco:730																				
type	<a href="#">m730:Titolo Terreno Type</a>																				
facets	<table border="1"> <thead> <tr> <th>Kind</th> <th>Value</th> </tr> </thead> <tbody> <tr> <td>pattern</td> <td>[1-9]{1}[0-9]*</td> </tr> <tr> <td>enumeration</td> <td>1</td> </tr> <tr> <td>enumeration</td> <td>2</td> </tr> <tr> <td>enumeration</td> <td>3</td> </tr> <tr> <td>enumeration</td> <td>4</td> </tr> <tr> <td>enumeration</td> <td>5</td> </tr> <tr> <td>enumeration</td> <td>6</td> </tr> <tr> <td>enumeration</td> <td>7</td> </tr> <tr> <td>enumeration</td> <td>10</td> </tr> </tbody> </table>	Kind	Value	pattern	[1-9]{1}[0-9]*	enumeration	1	enumeration	2	enumeration	3	enumeration	4	enumeration	5	enumeration	6	enumeration	7	enumeration	10
Kind	Value																				
pattern	[1-9]{1}[0-9]*																				
enumeration	1																				
enumeration	2																				
enumeration	3																				
enumeration	4																				
enumeration	5																				
enumeration	6																				
enumeration	7																				
enumeration	10																				

### element Terreno\_Type/RedAgrario

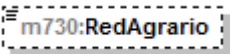
diagram					
namespace	urn:www.agenziaentrate.gov.it:specificheTecniche:sco:730				
type	<a href="#">DatoNP Type</a>				
facets	<table border="1"> <thead> <tr> <th>Kind</th> <th>Value</th> </tr> </thead> <tbody> <tr> <td>pattern</td> <td>[1-9]{1}[0-9]*</td> </tr> </tbody> </table>	Kind	Value	pattern	[1-9]{1}[0-9]*
Kind	Value				
pattern	[1-9]{1}[0-9]*				

### element Terreno\_Type/GiorniPossesso

diagram					
namespace	urn:www.agenziaentrate.gov.it:specificheTecniche:sco:730				
type	<a href="#">DatoGA Type</a>				
facets	<table border="1"> <thead> <tr> <th>Kind</th> <th>Value</th> </tr> </thead> <tbody> <tr> <td>pattern</td> <td>[1-9](((1-9)[0-9]) ((12)[0-9][0-9]) (3[0-5][0-9]) (36[0-5]))</td> </tr> </tbody> </table>	Kind	Value	pattern	[1-9](((1-9)[0-9]) ((12)[0-9][0-9]) (3[0-5][0-9]) (36[0-5]))
Kind	Value				
pattern	[1-9](((1-9)[0-9]) ((12)[0-9][0-9]) (3[0-5][0-9]) (36[0-5]))				

### element Terreno\_Type/PercPossesso

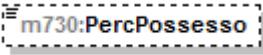
diagram					
namespace	urn:www.agenziaentrate.gov.it:specificheTecniche:sco:730				
type	<a href="#">DatoPC Type</a>				
facets	<table border="1"> <thead> <tr> <th>Kind</th> <th>Value</th> </tr> </thead> <tbody> <tr> <td>pattern</td> <td>[0-9]?[0-9](,\\d{1,3})? 100,(0{1,3})?</td> </tr> </tbody> </table>	Kind	Value	pattern	[0-9]?[0-9](,\\d{1,3})? 100,(0{1,3})?
Kind	Value				
pattern	[0-9]?[0-9](,\\d{1,3})? 100,(0{1,3})?				

**element Terreno\_Type/CanoneVincolistico**

diagram	 m730:CanoneVincolistico				
namespace	urn:www.agenziaentrate.gov.it:specificheTecniche:sco:730				
type	<a href="#">DatoNP_Type</a>				
facets	<table border="1"> <thead> <tr> <th>Kind</th> <th>Value</th> </tr> </thead> <tbody> <tr> <td>pattern</td> <td>[1-9]{1}[0-9]*</td> </tr> </tbody> </table>	Kind	Value	pattern	[1-9]{1}[0-9]*
Kind	Value				
pattern	[1-9]{1}[0-9]*				

**element Terreno\_Type/CasiParticolari**

diagram	 m730:CasiParticolari												
namespace	urn:www.agenziaentrate.gov.it:specificheTecniche:sco:730												
type	<a href="#">m730:Casi_Particolari_Terreni_Type</a>												
facets	<table border="1"> <thead> <tr> <th>Kind</th> <th>Value</th> </tr> </thead> <tbody> <tr> <td>pattern</td> <td>[1-9]</td> </tr> <tr> <td>enumeration</td> <td>2</td> </tr> <tr> <td>enumeration</td> <td>3</td> </tr> <tr> <td>enumeration</td> <td>4</td> </tr> <tr> <td>enumeration</td> <td>6</td> </tr> </tbody> </table>	Kind	Value	pattern	[1-9]	enumeration	2	enumeration	3	enumeration	4	enumeration	6
Kind	Value												
pattern	[1-9]												
enumeration	2												
enumeration	3												
enumeration	4												
enumeration	6												

**element Terreno\_Type/CasellaContinuazione**

diagram	 m730:CasellaContinuazione				
namespace	urn:www.agenziaentrate.gov.it:specificheTecniche:sco:730				
type	<a href="#">DatoCB_Type</a>				
facets	<table border="1"> <thead> <tr> <th>Kind</th> <th>Value</th> </tr> </thead> <tbody> <tr> <td>pattern</td> <td>[01]</td> </tr> </tbody> </table>	Kind	Value	pattern	[01]
Kind	Value				
pattern	[01]				

**element Terreno\_Type/CasellalmuNonDovuta**

diagram	 m730:CasellalmuNonDovuta				
namespace	urn:www.agenziaentrate.gov.it:specificheTecniche:sco:730				
type	<a href="#">DatoCB_Type</a>				
facets	<table border="1"> <thead> <tr> <th>Kind</th> <th>Value</th> </tr> </thead> <tbody> <tr> <td>pattern</td> <td>[01]</td> </tr> </tbody> </table>	Kind	Value	pattern	[01]
Kind	Value				
pattern	[01]				

**element Terreno\_Type/CasellaColtivatoreDiretto**

diagram	 m730:CasellaColtivatoreDiretto
namespace	urn:www.agenziaentrate.gov.it:specificheTecniche:sco:730
type	<a href="#">DatoCB_Type</a>

facets	Kind pattern	Value [01]
--------	--------------	------------

complexType **Versamenti\_F24\_Type**

<p>diagram</p>	
<p>namespace</p>	<p>urn:www.agenziaentrate.gov.it:specificheTecniche:sco:730</p>
<p>children</p>	<p><a href="#">m730:F24DebitoIrpef</a> <a href="#">m730:F24DebitoCodRegione</a> <a href="#">m730:F24DebitoAddReg</a> <a href="#">m730:F24DebitoCodComune</a> <a href="#">m730:F24DebitoAddCom</a> <a href="#">m730:F24DebitoPrimaRataAcclrpef</a> <a href="#">m730:F24DebitoAccontoTassSep</a> <a href="#">m730:F24DebitoCodComuneAcconto</a> <a href="#">m730:F24DebitoAccontoAddCom</a> <a href="#">m730:F24DebitoImpostaSost</a> <a href="#">m730:F24DebitoCedolare</a> <a href="#">m730:F24DebitoPrimaRataAccCedolare</a> <a href="#">m730:F24DebitoCodRegioneConiuge</a> <a href="#">m730:F24DebitoAddRegConiuge</a> <a href="#">m730:F24DebitoCodComuneConiuge</a> <a href="#">m730:F24DebitoAddComConiuge</a> <a href="#">m730:F24DebitoCodComuneAcc...</a> <a href="#">m730:F24DebitoAccontoAddCo...</a> <a href="#">m730:F24DebitoSecondaRataAcc...</a> <a href="#">m730:F24DebitoSecondaRataAcc...</a></p>

	<a href="#">m730:F24DebitoCodComuneAccontoConiuge</a> <a href="#">m730:F24DebitoAccontoAddComConiuge</a> <a href="#">m730:F24DebitoSecondaRataAcclrpef</a> <a href="#">m730:F24DebitoSecondaRataAccCedolare</a>
--	--

element **Versamenti\_F24\_Type/F24Debitolrpef**

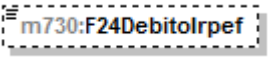
diagram					
namespace	urn:www.agenziaentrate.gov.it:specificheTecniche:sco:730				
type	<a href="#">DatoNP_Type</a>				
facets	<table border="1"> <thead> <tr> <th>Kind</th> <th>Value</th> </tr> </thead> <tbody> <tr> <td>pattern</td> <td>[1-9]{1}[0-9]*</td> </tr> </tbody> </table>	Kind	Value	pattern	[1-9]{1}[0-9]*
Kind	Value				
pattern	[1-9]{1}[0-9]*				

element **Versamenti\_F24\_Type/F24DebitoCodRegione**

diagram																																															
namespace	urn:www.agenziaentrate.gov.it:specificheTecniche:sco:730																																														
type	<a href="#">Codice_Regione_Type</a>																																														
facets	<table border="1"> <thead> <tr> <th>Kind</th> <th>Value</th> </tr> </thead> <tbody> <tr> <td>pattern</td> <td>([0-9A-Z-] \&amp;quot;){1}([ 0-9A-Z&amp;amp;] " - \., / \° \^ \( \) \À \È \É \  \Ò \Ù \Ü \&amp;quot; \ \\ \ +)*</td> </tr> <tr><td>enumeration</td><td>1</td></tr> <tr><td>enumeration</td><td>2</td></tr> <tr><td>enumeration</td><td>3</td></tr> <tr><td>enumeration</td><td>4</td></tr> <tr><td>enumeration</td><td>5</td></tr> <tr><td>enumeration</td><td>6</td></tr> <tr><td>enumeration</td><td>7</td></tr> <tr><td>enumeration</td><td>8</td></tr> <tr><td>enumeration</td><td>9</td></tr> <tr><td>enumeration</td><td>10</td></tr> <tr><td>enumeration</td><td>11</td></tr> <tr><td>enumeration</td><td>12</td></tr> <tr><td>enumeration</td><td>13</td></tr> <tr><td>enumeration</td><td>14</td></tr> <tr><td>enumeration</td><td>15</td></tr> <tr><td>enumeration</td><td>16</td></tr> <tr><td>enumeration</td><td>17</td></tr> <tr><td>enumeration</td><td>18</td></tr> <tr><td>enumeration</td><td>19</td></tr> <tr><td>enumeration</td><td>20</td></tr> <tr><td>enumeration</td><td>21</td></tr> </tbody> </table>	Kind	Value	pattern	([0-9A-Z-] \&quot;){1}([ 0-9A-Z&amp;] " - \., / \° \^ \( \) \À \È \É \  \Ò \Ù \Ü \&quot; \ \\ \ +)*	enumeration	1	enumeration	2	enumeration	3	enumeration	4	enumeration	5	enumeration	6	enumeration	7	enumeration	8	enumeration	9	enumeration	10	enumeration	11	enumeration	12	enumeration	13	enumeration	14	enumeration	15	enumeration	16	enumeration	17	enumeration	18	enumeration	19	enumeration	20	enumeration	21
Kind	Value																																														
pattern	([0-9A-Z-] \&quot;){1}([ 0-9A-Z&amp;] " - \., / \° \^ \( \) \À \È \É \  \Ò \Ù \Ü \&quot; \ \\ \ +)*																																														
enumeration	1																																														
enumeration	2																																														
enumeration	3																																														
enumeration	4																																														
enumeration	5																																														
enumeration	6																																														
enumeration	7																																														
enumeration	8																																														
enumeration	9																																														
enumeration	10																																														
enumeration	11																																														
enumeration	12																																														
enumeration	13																																														
enumeration	14																																														
enumeration	15																																														
enumeration	16																																														
enumeration	17																																														
enumeration	18																																														
enumeration	19																																														
enumeration	20																																														
enumeration	21																																														

element **Versamenti\_F24\_Type/F24DebitoAddReg**

diagram					
namespace	urn:www.agenziaentrate.gov.it:specificheTecniche:sco:730				
type	<a href="#">DatoNP_Type</a>				
facets	<table border="1"> <thead> <tr> <th>Kind</th> <th>Value</th> </tr> </thead> <tbody> <tr> <td>pattern</td> <td>[1-9]{1}[0-9]*</td> </tr> </tbody> </table>	Kind	Value	pattern	[1-9]{1}[0-9]*
Kind	Value				
pattern	[1-9]{1}[0-9]*				

element **Versamenti\_F24\_Type/F24DebitoCodComune**

diagram	 m730:F24DebitoCodComune
namespace	urn:www.agenziaentrate.gov.it:specificheTecniche:sco:730
type	<a href="#">DatoAN_Type</a>
facets	Kind Value pattern ([0-9A-Z\-\-]&quot;){1}([ 0-9A-Z&amp;:] \- \., / \^\(\ \)\À È É Ì Ò Ù Ü &quot; \ \ \ +)*

element **Versamenti\_F24\_Type/F24DebitoAddCom**

diagram	 m730:F24DebitoAddCom
namespace	urn:www.agenziaentrate.gov.it:specificheTecniche:sco:730
type	<a href="#">DatoNP_Type</a>
facets	Kind Value pattern [1-9]{1}[0-9]*

element **Versamenti\_F24\_Type/F24DebitoPrimaRataAcclrpef**

diagram	 m730:F24DebitoPrimaRataAcclrpef
namespace	urn:www.agenziaentrate.gov.it:specificheTecniche:sco:730
type	<a href="#">DatoNP_Type</a>
facets	Kind Value pattern [1-9]{1}[0-9]*

element **Versamenti\_F24\_Type/F24DebitoAccontoTassSep**

diagram	 m730:F24DebitoAccontoTass Sep
namespace	urn:www.agenziaentrate.gov.it:specificheTecniche:sco:730
type	<a href="#">DatoNP_Type</a>
facets	Kind Value pattern [1-9]{1}[0-9]*

element **Versamenti\_F24\_Type/F24DebitoCodComuneAcconto**

diagram	 m730:F24DebitoCodComuneAcc...
namespace	urn:www.agenziaentrate.gov.it:specificheTecniche:sco:730
type	<a href="#">DatoAN_Type</a>
facets	Kind Value pattern ([0-9A-Z\-\-]&quot;){1}([ 0-9A-Z&amp;:] \- \., / \^\(\ \)\À È É Ì Ò Ù Ü &quot; \ \ \ +)*

element **Versamenti\_F24\_Type/F24DebitoAccontoAddCom**

diagram	 m730:F24DebitoAccontoAddCom
namespace	urn:www.agenziaentrate.gov.it:specificheTecniche:sco:730
type	<a href="#">DatoNP_Type</a>
facets	Kind Value pattern [1-9]{1}[0-9]*

element **Versamenti\_F24\_Type/F24DebitoImpostaSost**

diagram	 m730:F24DebitoImpostaSost
namespace	urn:www.agenziaentrate.gov.it:specificheTecniche:sco:730
type	<a href="#">DatoNP_Type</a>
facets	Kind Value pattern [1-9]{1}[0-9]*

element **Versamenti\_F24\_Type/F24DebitoCedolare**

diagram	 m730:F24DebitoCedolare
namespace	urn:www.agenziaentrate.gov.it:specificheTecniche:sco:730
type	<a href="#">DatoNP_Type</a>
facets	Kind Value pattern [1-9]{1}[0-9]*

element **Versamenti\_F24\_Type/F24DebitoPrimaRataAccCedolare**

diagram	 m730:F24DebitoPrimaRataAccCe...
namespace	urn:www.agenziaentrate.gov.it:specificheTecniche:sco:730
type	<a href="#">DatoNP_Type</a>
facets	Kind Value pattern [1-9]{1}[0-9]*

element **Versamenti\_F24\_Type/F24DebitoCodRegioneConiuge**

diagram	 m730:F24DebitoCodRegioneConi...
namespace	urn:www.agenziaentrate.gov.it:specificheTecniche:sco:730
type	<a href="#">Codice Regione Type</a>
facets	Kind Value pattern (([0-9A-Z-] \&quot;){1}([ 0-9A-Z&amp;:] \- \., / \^\ \( \) \À \É \  \Ò \Ù \Û \&quot; \N \+)*



enumeration	1
enumeration	2
enumeration	3
enumeration	4
enumeration	5
enumeration	6
enumeration	7
enumeration	8
enumeration	9
enumeration	10
enumeration	11
enumeration	12
enumeration	13
enumeration	14
enumeration	15
enumeration	16
enumeration	17
enumeration	18
enumeration	19
enumeration	20
enumeration	21

**element Versamenti\_F24\_Type/F24DebitoAddRegConiuge**

diagram	 m730:F24DebitoAddRegConiuge				
namespace	urn:www.agenziaentrate.gov.it:specificheTecniche:sco:730				
type	<a href="#">DatoNP_Type</a>				
facets	<table border="1"> <thead> <tr> <th>Kind</th> <th>Value</th> </tr> </thead> <tbody> <tr> <td>pattern</td> <td>[1-9]{1}[0-9]*</td> </tr> </tbody> </table>	Kind	Value	pattern	[1-9]{1}[0-9]*
Kind	Value				
pattern	[1-9]{1}[0-9]*				

**element Versamenti\_F24\_Type/F24DebitoCodComuneConiuge**

diagram	 m730:F24DebitoCodComuneCon...				
namespace	urn:www.agenziaentrate.gov.it:specificheTecniche:sco:730				
type	<a href="#">DatoAN_Type</a>				
facets	<table border="1"> <thead> <tr> <th>Kind</th> <th>Value</th> </tr> </thead> <tbody> <tr> <td>pattern</td> <td>([0-9A-Z\-\_]&amp;quot;){1}([ 0-9A-Z&amp;amp;:] ' \- \_ / ° °\°\(\ )\ À É È Ì Ò Ù Û &amp;quot; \N\ +)*</td> </tr> </tbody> </table>	Kind	Value	pattern	([0-9A-Z\-\_]&quot;){1}([ 0-9A-Z&amp;:] ' \- \_ / ° °\°\(\ )\ À É È Ì Ò Ù Û &quot; \N\ +)*
Kind	Value				
pattern	([0-9A-Z\-\_]&quot;){1}([ 0-9A-Z&amp;:] ' \- \_ / ° °\°\(\ )\ À É È Ì Ò Ù Û &quot; \N\ +)*				

**element Versamenti\_F24\_Type/F24DebitoAddComConiuge**

diagram	 m730:F24DebitoAddComConiuge				
namespace	urn:www.agenziaentrate.gov.it:specificheTecniche:sco:730				
type	<a href="#">DatoNP_Type</a>				
facets	<table border="1"> <thead> <tr> <th>Kind</th> <th>Value</th> </tr> </thead> <tbody> <tr> <td>pattern</td> <td>[1-9]{1}[0-9]*</td> </tr> </tbody> </table>	Kind	Value	pattern	[1-9]{1}[0-9]*
Kind	Value				
pattern	[1-9]{1}[0-9]*				

element **Versamenti\_F24\_Type/F24DebitoCodComuneAccontoConiuge**

diagram	
namespace	urn:www.agenziaentrate.gov.it:specificheTecniche:sco:730
type	<a href="#">DatoAN_Type</a>
facets	Kind Value pattern ([0-9A-Z-] \&quot;){1}([ 0-9A-Z&amp;:] ' - \., / ° ^\ \\( \) À É È Ì Ò Ù Ü &quot; \ \\ /+)*

element **Versamenti\_F24\_Type/F24DebitoAccontoAddComConiuge**

diagram	
namespace	urn:www.agenziaentrate.gov.it:specificheTecniche:sco:730
type	<a href="#">DatoNP_Type</a>
facets	Kind Value pattern [1-9]{1}[0-9]*

element **Versamenti\_F24\_Type/F24DebitoSecondaRataAcclrpef**

diagram	
namespace	urn:www.agenziaentrate.gov.it:specificheTecniche:sco:730
type	<a href="#">DatoNP_Type</a>
facets	Kind Value pattern [1-9]{1}[0-9]*

element **Versamenti\_F24\_Type/F24DebitoSecondaRataAccCedolare**

diagram	
namespace	urn:www.agenziaentrate.gov.it:specificheTecniche:sco:730
type	<a href="#">DatoNP_Type</a>
facets	Kind Value pattern [1-9]{1}[0-9]*

element **Intestazione**

diagram	
namespace	urn:www.agenziaentrate.gov.it:specificheTecniche:sco:730

type	<a href="#">m730:Intestazione_730_Type</a>
children	<a href="#">m730:TipoFornitore</a> <a href="#">m730:SpazioUtente</a>

### complexType Intestazione\_730\_Type

diagram	
namespace	urn:www.agenziaentrate.gov.it:specificheTecniche:sco:730
children	<a href="#">m730:TipoFornitore</a> <a href="#">m730:SpazioUtente</a>

### element Intestazione\_730\_Type/TipoFornitore

diagram																	
namespace	urn:www.agenziaentrate.gov.it:specificheTecniche:sco:730																
type	restriction of <a href="#">DatoAN_Type</a>																
facets	<table border="1"> <thead> <tr> <th>Kind</th> <th>Value</th> </tr> </thead> <tbody> <tr> <td>pattern</td> <td>([0-9A-Z-] \&amp;quot;){1}([ 0-9A-Z&amp;amp;] ' - \., / ° °\ (\ )À È É Ì Ò Ù Ü &amp;quot;; \\ / +)*</td> </tr> <tr> <td>enumeration</td> <td>1</td> </tr> <tr> <td>enumeration</td> <td>2</td> </tr> <tr> <td>enumeration</td> <td>3</td> </tr> <tr> <td>enumeration</td> <td>5</td> </tr> <tr> <td>enumeration</td> <td>6</td> </tr> <tr> <td>enumeration</td> <td>10</td> </tr> </tbody> </table>	Kind	Value	pattern	([0-9A-Z-] \&quot;){1}([ 0-9A-Z&amp;] ' - \., / ° °\ (\ )À È É Ì Ò Ù Ü &quot;; \\ / +)*	enumeration	1	enumeration	2	enumeration	3	enumeration	5	enumeration	6	enumeration	10
Kind	Value																
pattern	([0-9A-Z-] \&quot;){1}([ 0-9A-Z&amp;] ' - \., / ° °\ (\ )À È É Ì Ò Ù Ü &quot;; \\ / +)*																
enumeration	1																
enumeration	2																
enumeration	3																
enumeration	5																
enumeration	6																
enumeration	10																

### element Intestazione\_730\_Type/SpazioUtente

diagram					
namespace	urn:www.agenziaentrate.gov.it:specificheTecniche:sco:730				
type	<a href="#">DatoAN_Type</a>				
facets	<table border="1"> <thead> <tr> <th>Kind</th> <th>Value</th> </tr> </thead> <tbody> <tr> <td>pattern</td> <td>([0-9A-Z-] \&amp;quot;){1}([ 0-9A-Z&amp;amp;] ' - \., / ° °\ (\ )À È É Ì Ò Ù Ü &amp;quot;; \\ / +)*</td> </tr> </tbody> </table>	Kind	Value	pattern	([0-9A-Z-] \&quot;){1}([ 0-9A-Z&amp;] ' - \., / ° °\ (\ )À È É Ì Ò Ù Ü &quot;; \\ / +)*
Kind	Value				
pattern	([0-9A-Z-] \&quot;){1}([ 0-9A-Z&amp;] ' - \., / ° °\ (\ )À È É Ì Ò Ù Ü &quot;; \\ / +)*				

### element Fornitura

diagram	
namespace	www.agenziaentrate.gov.it:specificheTecniche:telent:v1

element **Messaggio**

diagram	
namespace	www.agenziaentrate.gov.it:specificheTecniche:telent:v1
children	<a href="#">tm:Intestazione</a> <a href="#">tm:Contenuto</a>

element **Messaggio/Intestazione**

diagram	
namespace	www.agenziaentrate.gov.it:specificheTecniche:telent:v1
type	<a href="#">tm:IntestazioneType</a>
children	<a href="#">tm:CodiceFiscaleFornitore</a> <a href="#">tm:SpazioServizioTelematico</a>

element **Messaggio/Contenuto**

diagram											
namespace	www.agenziaentrate.gov.it:specificheTecniche:telent:v1										
type	<a href="#">tm:ContenutoType</a>										
children	<a href="#">tm:Fornitura</a>										
attributes	<table border="1"> <thead> <tr> <th>Name</th> <th>Type</th> <th>Use</th> <th>Default</th> <th>Fixed</th> </tr> </thead> <tbody> <tr> <td><a href="#">CodiceFornitura</a></td> <td>derived by: xs:string</td> <td></td> <td></td> <td></td> </tr> </tbody> </table>	Name	Type	Use	Default	Fixed	<a href="#">CodiceFornitura</a>	derived by: xs:string			
Name	Type	Use	Default	Fixed							
<a href="#">CodiceFornitura</a>	derived by: xs:string										

### complexType **ContenutoType**

diagram					
namespace	www.agenziaentrate.gov.it:specificheTecniche:telent:v1				
children	<a href="#">tm:Fornitura</a>				
attributes	Name	Type	Use	Default	Fixed
	<a href="#">CodiceFornitura</a>	derived by: xs:string			

### attribute **ContenutoType/@CodiceFornitura**

type	restriction of <b>xs:string</b>	
facets	Kind	Value
	pattern	[A-Z0-9]{5}

### complexType **IntestazioneType**

diagram					
namespace	www.agenziaentrate.gov.it:specificheTecniche:telent:v1				
children	<a href="#">tm:CodiceFiscaleFornitore</a> <a href="#">tm:Spazio Servizio Telematico</a>				

### element **IntestazioneType/CodiceFiscaleFornitore**

diagram					
namespace	www.agenziaentrate.gov.it:specificheTecniche:telent:v1				
type	restriction of <b>xs:string</b>				
facets	Kind	Value			
	pattern	[0-9]{11}[A-Z0-9]{16}			

### element **IntestazioneType/Spazio Servizio Telematico**

diagram					
namespace	www.agenziaentrate.gov.it:specificheTecniche:telent:v1				

type	restriction of <b>xs:string</b>
------	---------------------------------

### simpleType **Anno\_Anticipazione\_Fondo\_Pensione\_Type**

namespace	urn:www.agenziaentrate.gov.it:specificheTecniche:sco:730																										
type	restriction of <a href="#">DatoNP_Type</a>																										
facets	<table border="1"> <thead> <tr> <th>Kind</th> <th>Value</th> </tr> </thead> <tbody> <tr> <td>pattern</td> <td>[1-9]{1}[0-9]*</td> </tr> <tr> <td>enumeration</td> <td>2007</td> </tr> <tr> <td>enumeration</td> <td>2008</td> </tr> <tr> <td>enumeration</td> <td>2009</td> </tr> <tr> <td>enumeration</td> <td>2010</td> </tr> <tr> <td>enumeration</td> <td>2011</td> </tr> <tr> <td>enumeration</td> <td>2012</td> </tr> <tr> <td>enumeration</td> <td>2013</td> </tr> <tr> <td>enumeration</td> <td>2014</td> </tr> <tr> <td>enumeration</td> <td>2015</td> </tr> <tr> <td>enumeration</td> <td>2016</td> </tr> <tr> <td>enumeration</td> <td>2017</td> </tr> </tbody> </table>	Kind	Value	pattern	[1-9]{1}[0-9]*	enumeration	2007	enumeration	2008	enumeration	2009	enumeration	2010	enumeration	2011	enumeration	2012	enumeration	2013	enumeration	2014	enumeration	2015	enumeration	2016	enumeration	2017
Kind	Value																										
pattern	[1-9]{1}[0-9]*																										
enumeration	2007																										
enumeration	2008																										
enumeration	2009																										
enumeration	2010																										
enumeration	2011																										
enumeration	2012																										
enumeration	2013																										
enumeration	2014																										
enumeration	2015																										
enumeration	2016																										
enumeration	2017																										

### simpleType **Anno\_Recupero\_Patrimonio\_Edilizio\_Type**

namespace	urn:www.agenziaentrate.gov.it:specificheTecniche:sco:730																								
type	restriction of <a href="#">DatoNP_Type</a>																								
facets	<table border="1"> <thead> <tr> <th>Kind</th> <th>Value</th> </tr> </thead> <tbody> <tr> <td>pattern</td> <td>[1-9]{1}[0-9]*</td> </tr> <tr> <td>enumeration</td> <td>2008</td> </tr> <tr> <td>enumeration</td> <td>2009</td> </tr> <tr> <td>enumeration</td> <td>2010</td> </tr> <tr> <td>enumeration</td> <td>2011</td> </tr> <tr> <td>enumeration</td> <td>2012</td> </tr> <tr> <td>enumeration</td> <td>2013</td> </tr> <tr> <td>enumeration</td> <td>2014</td> </tr> <tr> <td>enumeration</td> <td>2015</td> </tr> <tr> <td>enumeration</td> <td>2016</td> </tr> <tr> <td>enumeration</td> <td>2017</td> </tr> </tbody> </table>	Kind	Value	pattern	[1-9]{1}[0-9]*	enumeration	2008	enumeration	2009	enumeration	2010	enumeration	2011	enumeration	2012	enumeration	2013	enumeration	2014	enumeration	2015	enumeration	2016	enumeration	2017
Kind	Value																								
pattern	[1-9]{1}[0-9]*																								
enumeration	2008																								
enumeration	2009																								
enumeration	2010																								
enumeration	2011																								
enumeration	2012																								
enumeration	2013																								
enumeration	2014																								
enumeration	2015																								
enumeration	2016																								
enumeration	2017																								

### simpleType **Anno\_Risparmio\_Energetico\_Type**

namespace	urn:www.agenziaentrate.gov.it:specificheTecniche:sco:730																				
type	restriction of <a href="#">DatoNP_Type</a>																				
facets	<table border="1"> <thead> <tr> <th>Kind</th> <th>Value</th> </tr> </thead> <tbody> <tr> <td>pattern</td> <td>[1-9]{1}[0-9]*</td> </tr> <tr> <td>enumeration</td> <td>2008</td> </tr> <tr> <td>enumeration</td> <td>2011</td> </tr> <tr> <td>enumeration</td> <td>2012</td> </tr> <tr> <td>enumeration</td> <td>2013</td> </tr> <tr> <td>enumeration</td> <td>2014</td> </tr> <tr> <td>enumeration</td> <td>2015</td> </tr> <tr> <td>enumeration</td> <td>2016</td> </tr> <tr> <td>enumeration</td> <td>2016</td> </tr> </tbody> </table>	Kind	Value	pattern	[1-9]{1}[0-9]*	enumeration	2008	enumeration	2011	enumeration	2012	enumeration	2013	enumeration	2014	enumeration	2015	enumeration	2016	enumeration	2016
Kind	Value																				
pattern	[1-9]{1}[0-9]*																				
enumeration	2008																				
enumeration	2011																				
enumeration	2012																				
enumeration	2013																				
enumeration	2014																				
enumeration	2015																				
enumeration	2016																				
enumeration	2016																				

### simpleType **Casi\_Particolari\_Fabbricato\_Type**

namespace	urn:www.agenziaentrate.gov.it:specificheTecniche:sco:730
-----------	--

type	restriction of <a href="#">DatoN1_Type</a>												
facets	<table> <thead> <tr> <th>Kind</th> <th>Value</th> </tr> </thead> <tbody> <tr> <td>pattern</td> <td>[1-9]</td> </tr> <tr> <td>enumeration</td> <td>1</td> </tr> <tr> <td>enumeration</td> <td>3</td> </tr> <tr> <td>enumeration</td> <td>4</td> </tr> <tr> <td>enumeration</td> <td>5</td> </tr> </tbody> </table>	Kind	Value	pattern	[1-9]	enumeration	1	enumeration	3	enumeration	4	enumeration	5
Kind	Value												
pattern	[1-9]												
enumeration	1												
enumeration	3												
enumeration	4												
enumeration	5												

### simpleType **Casi\_Particolari\_Risp\_Ener\_Type**

namespace	urn:www.agenziaentrate.gov.it:specificheTecniche:sco:730										
type	restriction of <a href="#">DatoN1_Type</a>										
facets	<table> <thead> <tr> <th>Kind</th> <th>Value</th> </tr> </thead> <tbody> <tr> <td>pattern</td> <td>[1-9]</td> </tr> <tr> <td>enumeration</td> <td>1</td> </tr> <tr> <td>enumeration</td> <td>2</td> </tr> <tr> <td>enumeration</td> <td>3</td> </tr> </tbody> </table>	Kind	Value	pattern	[1-9]	enumeration	1	enumeration	2	enumeration	3
Kind	Value										
pattern	[1-9]										
enumeration	1										
enumeration	2										
enumeration	3										

### simpleType **Casi\_Particolari\_Terreni\_Type**

namespace	urn:www.agenziaentrate.gov.it:specificheTecniche:sco:730												
type	restriction of <a href="#">DatoN1_Type</a>												
facets	<table> <thead> <tr> <th>Kind</th> <th>Value</th> </tr> </thead> <tbody> <tr> <td>pattern</td> <td>[1-9]</td> </tr> <tr> <td>enumeration</td> <td>2</td> </tr> <tr> <td>enumeration</td> <td>3</td> </tr> <tr> <td>enumeration</td> <td>4</td> </tr> <tr> <td>enumeration</td> <td>6</td> </tr> </tbody> </table>	Kind	Value	pattern	[1-9]	enumeration	2	enumeration	3	enumeration	4	enumeration	6
Kind	Value												
pattern	[1-9]												
enumeration	2												
enumeration	3												
enumeration	4												
enumeration	6												

### simpleType **Codice\_Altre\_Detrazioni\_Type**

namespace	urn:www.agenziaentrate.gov.it:specificheTecniche:sco:730								
type	restriction of <a href="#">DatoNP_Type</a>								
facets	<table> <thead> <tr> <th>Kind</th> <th>Value</th> </tr> </thead> <tbody> <tr> <td>pattern</td> <td>[1-9]{1}[0-9]*</td> </tr> <tr> <td>enumeration</td> <td>1</td> </tr> <tr> <td>enumeration</td> <td>2</td> </tr> </tbody> </table>	Kind	Value	pattern	[1-9]{1}[0-9]*	enumeration	1	enumeration	2
Kind	Value								
pattern	[1-9]{1}[0-9]*								
enumeration	1								
enumeration	2								

### simpleType **Codice\_Altre\_Spese\_Type**

namespace	urn:www.agenziaentrate.gov.it:specificheTecniche:sco:730																										
type	restriction of <a href="#">DatoNP_Type</a>																										
facets	<table> <thead> <tr> <th>Kind</th> <th>Value</th> </tr> </thead> <tbody> <tr> <td>pattern</td> <td>[1-9]{1}[0-9]*</td> </tr> <tr> <td>enumeration</td> <td>8</td> </tr> <tr> <td>enumeration</td> <td>9</td> </tr> <tr> <td>enumeration</td> <td>10</td> </tr> <tr> <td>enumeration</td> <td>11</td> </tr> <tr> <td>enumeration</td> <td>12</td> </tr> <tr> <td>enumeration</td> <td>13</td> </tr> <tr> <td>enumeration</td> <td>14</td> </tr> <tr> <td>enumeration</td> <td>15</td> </tr> <tr> <td>enumeration</td> <td>16</td> </tr> <tr> <td>enumeration</td> <td>17</td> </tr> <tr> <td>enumeration</td> <td>18</td> </tr> </tbody> </table>	Kind	Value	pattern	[1-9]{1}[0-9]*	enumeration	8	enumeration	9	enumeration	10	enumeration	11	enumeration	12	enumeration	13	enumeration	14	enumeration	15	enumeration	16	enumeration	17	enumeration	18
Kind	Value																										
pattern	[1-9]{1}[0-9]*																										
enumeration	8																										
enumeration	9																										
enumeration	10																										
enumeration	11																										
enumeration	12																										
enumeration	13																										
enumeration	14																										
enumeration	15																										
enumeration	16																										
enumeration	17																										
enumeration	18																										

enumeration	20
enumeration	21
enumeration	22
enumeration	23
enumeration	24
enumeration	25
enumeration	26
enumeration	27
enumeration	28
enumeration	29
enumeration	30
enumeration	31
enumeration	32
enumeration	33
enumeration	35
enumeration	36
enumeration	38
enumeration	39
enumeration	41
enumeration	42
enumeration	99

### simpleType **Codice\_Altri\_Oneri\_Type**

namespace	urn:www.agenziaentrate.gov.it:specificheTecniche:sco:730																		
type	restriction of <a href="#">DatoNP_Type</a>																		
facets	<table border="1"> <thead> <tr><th>Kind</th><th>Value</th></tr> </thead> <tbody> <tr><td>pattern</td><td>[1-9]{1}[0-9]*</td></tr> <tr><td>enumeration</td><td>6</td></tr> <tr><td>enumeration</td><td>7</td></tr> <tr><td>enumeration</td><td>8</td></tr> <tr><td>enumeration</td><td>9</td></tr> <tr><td>enumeration</td><td>12</td></tr> <tr><td>enumeration</td><td>13</td></tr> <tr><td>enumeration</td><td>21</td></tr> </tbody> </table>	Kind	Value	pattern	[1-9]{1}[0-9]*	enumeration	6	enumeration	7	enumeration	8	enumeration	9	enumeration	12	enumeration	13	enumeration	21
Kind	Value																		
pattern	[1-9]{1}[0-9]*																		
enumeration	6																		
enumeration	7																		
enumeration	8																		
enumeration	9																		
enumeration	12																		
enumeration	13																		
enumeration	21																		

### simpleType **Codice\_Canone\_Type**

namespace	urn:www.agenziaentrate.gov.it:specificheTecniche:sco:730												
type	restriction of <a href="#">DatoN1_Type</a>												
facets	<table border="1"> <thead> <tr><th>Kind</th><th>Value</th></tr> </thead> <tbody> <tr><td>pattern</td><td>[1-9]</td></tr> <tr><td>enumeration</td><td>1</td></tr> <tr><td>enumeration</td><td>2</td></tr> <tr><td>enumeration</td><td>3</td></tr> <tr><td>enumeration</td><td>4</td></tr> </tbody> </table>	Kind	Value	pattern	[1-9]	enumeration	1	enumeration	2	enumeration	3	enumeration	4
Kind	Value												
pattern	[1-9]												
enumeration	1												
enumeration	2												
enumeration	3												
enumeration	4												

### simpleType **Codice\_Evento\_Eccezionale\_Type**

namespace	urn:www.agenziaentrate.gov.it:specificheTecniche:sco:730																
type	restriction of <a href="#">DatoNP_Type</a>																
facets	<table border="1"> <thead> <tr><th>Kind</th><th>Value</th></tr> </thead> <tbody> <tr><td>pattern</td><td>[1-9]{1}[0-9]*</td></tr> <tr><td>enumeration</td><td>1</td></tr> <tr><td>enumeration</td><td>2</td></tr> <tr><td>enumeration</td><td>3</td></tr> <tr><td>enumeration</td><td>4</td></tr> <tr><td>enumeration</td><td>5</td></tr> <tr><td>enumeration</td><td>6</td></tr> </tbody> </table>	Kind	Value	pattern	[1-9]{1}[0-9]*	enumeration	1	enumeration	2	enumeration	3	enumeration	4	enumeration	5	enumeration	6
Kind	Value																
pattern	[1-9]{1}[0-9]*																
enumeration	1																
enumeration	2																
enumeration	3																
enumeration	4																
enumeration	5																
enumeration	6																



**simpleType Codice\_Spese\_Rateizzate\_Anni\_Precedenti\_Type**

namespace	urn:www.agenziaentrate.gov.it:specificheTecniche:sco:730	
type	restriction of <a href="#">DatoNP_Type</a>	
facets	Kind	Value
	pattern	[1-9]{1}[0-9]*
	enumeration	2
	enumeration	3
	enumeration	4

**simpleType Codice\_Spese\_Rateizzate\_Type**

namespace	urn:www.agenziaentrate.gov.it:specificheTecniche:sco:730	
type	restriction of <a href="#">DatoNP_Type</a>	
facets	Kind	Value
	pattern	[1-9]{1}[0-9]*
	enumeration	1
	enumeration	2
	enumeration	3
	enumeration	4

**simpleType Fabbricato\_Agev\_Numero\_Rigo\_Type**

namespace	urn:www.agenziaentrate.gov.it:specificheTecniche:sco:730	
type	restriction of <a href="#">DatoNP_Type</a>	
facets	Kind	Value
	pattern	[1-9]{1}[0-9]*
	enumeration	1
	enumeration	2
	enumeration	3
	enumeration	4
	enumeration	5
	enumeration	6
	enumeration	7
	enumeration	8
	enumeration	9
	enumeration	10

**simpleType Indeterminato\_Determinato\_Type**

namespace	urn:www.agenziaentrate.gov.it:specificheTecniche:sco:730	
type	restriction of <a href="#">DatoN1_Type</a>	
facets	Kind	Value
	pattern	[1-9]
	enumeration	1
	enumeration	2

**simpleType Integrativo\_Type**

namespace	urn:www.agenziaentrate.gov.it:specificheTecniche:sco:730	
type	restriction of <a href="#">DatoN1_Type</a>	

facets	Kind	Value
	pattern	[1-9]
	enumeration	1
	enumeration	2
	enumeration	3

### simpleType Mesi\_Type

namespace	urn:www.agenziaentrate.gov.it:specificheTecniche:sco:730	
type	restriction of <a href="#">DatoNP_Type</a>	
facets	Kind	Value
	pattern	[1-9]{1}[0-9]*
	enumeration	1
	enumeration	2
	enumeration	3
	enumeration	4
	enumeration	5
	enumeration	6
	enumeration	7
	enumeration	8
	enumeration	9
	enumeration	10
	enumeration	11
enumeration	12	

### simpleType Numero\_Rata\_Risparmio\_Energetico\_Type

namespace	urn:www.agenziaentrate.gov.it:specificheTecniche:sco:730	
type	restriction of <a href="#">DatoNP_Type</a>	
facets	Kind	Value
	pattern	[1-9]{1}[0-9]*
	enumeration	1
	enumeration	2
	enumeration	3
	enumeration	4
	enumeration	5
	enumeration	6
	enumeration	7
	enumeration	10

### simpleType Periodo\_Spese\_Ristrutturazione\_Type

namespace	urn:www.agenziaentrate.gov.it:specificheTecniche:sco:730	
type	restriction of <a href="#">DatoNP_Type</a>	
facets	Kind	Value
	pattern	[1-9]{1}[0-9]*
	enumeration	2
	enumeration	3
	enumeration	4
	enumeration	5
	enumeration	6
	enumeration	7
	enumeration	8
	enumeration	9
	enumeration	10
enumeration	11	

### simpleType **Rate10\_Type**

namespace	urn:www.agenziaentrate.gov.it:specificheTecniche:sco:730	
type	restriction of <a href="#">DatoNP_Type</a>	
facets	Kind	Value
	pattern	[1-9]{1}[0-9]*
	enumeration	1
	enumeration	2
	enumeration	3
	enumeration	4
	enumeration	5
	enumeration	6
	enumeration	7
	enumeration	8
	enumeration	9
	enumeration	10

### simpleType **Rate\_Risparmio\_Energetico\_Type**

namespace	urn:www.agenziaentrate.gov.it:specificheTecniche:sco:730	
type	restriction of <a href="#">DatoNP_Type</a>	
facets	Kind	Value
	pattern	[1-9]{1}[0-9]*
	enumeration	4
	enumeration	5
	enumeration	6
	enumeration	7
	enumeration	8
	enumeration	9
	enumeration	10

### simpleType **Reintegro\_Totale\_Parziale\_Type**

namespace	urn:www.agenziaentrate.gov.it:specificheTecniche:sco:730	
type	restriction of <a href="#">DatoN1_Type</a>	
facets	Kind	Value
	pattern	[1-9]
	enumeration	1
	enumeration	2

### simpleType **Rettificativo\_Type**

namespace	urn:www.agenziaentrate.gov.it:specificheTecniche:sco:730	
type	restriction of <a href="#">DatoN1_Type</a>	
facets	Kind	Value
	pattern	[1-9]
	enumeration	1
	enumeration	2
	enumeration	3

### simpleType **Serie\_Registrazione\_Contratto\_Type**

namespace	urn:www.agenziaentrate.gov.it:specificheTecniche:sco:730	
type	restriction of <a href="#">DatoAN_Type</a>	

facets	Kind	Value
	pattern	([0-9A-Z-])&quot;){1}([ 0-9A-Z&amp;]) ' - \. , /° ^\(\\ )À È É ì Ò Ù Ü &quot; \\ /+)*
	enumeration	3
	enumeration	3A
	enumeration	3B
	enumeration	3P
	enumeration	1T
	enumeration	3T

### simpleType **Stato\_Civile\_Type**

namespace	urn:www.agenziaentrate.gov.it:specificheTecniche:sco:730	
type	restriction of <a href="#">DatoNP_Type</a>	
facets	Kind	Value
	pattern	[1-9]{1}[0-9]*
	enumeration	7
	enumeration	8

### simpleType **Terreni\_Urbano\_Type**

namespace	urn:www.agenziaentrate.gov.it:specificheTecniche:sco:730	
type	restriction of <a href="#">DatoAN_Type</a>	
facets	Kind	Value
	pattern	([0-9A-Z-])&quot;){1}([ 0-9A-Z&amp;]) ' - \. , /° ^\(\\ )À È É ì Ò Ù Ü &quot; \\ /+)*
	enumeration	T
	enumeration	U

### simpleType **Tipo\_Inquilino\_Type**

namespace	urn:www.agenziaentrate.gov.it:specificheTecniche:sco:730	
type	restriction of <a href="#">DatoNP_Type</a>	
facets	Kind	Value
	pattern	[1-9]{1}[0-9]*
	enumeration	1
	enumeration	2
	enumeration	3

### simpleType **Tipo\_Intervento\_Type**

namespace	urn:www.agenziaentrate.gov.it:specificheTecniche:sco:730	
type	restriction of <a href="#">DatoN1_Type</a>	
facets	Kind	Value
	pattern	[1-9]
	enumeration	1
	enumeration	2
	enumeration	3
	enumeration	4
	enumeration	5
	enumeration	6
	enumeration	7
	enumeration	8
	enumeration	9

### simpleType **Tipo\_Reddito\_Da1a4\_Type**

namespace	urn:www.agenziaentrate.gov.it:specificheTecniche:sco:730												
type	restriction of <a href="#">DatoN1_Type</a>												
facets	<table><thead><tr><th>Kind</th><th>Value</th></tr></thead><tbody><tr><td>pattern</td><td>[1-9]</td></tr><tr><td>enumeration</td><td>1</td></tr><tr><td>enumeration</td><td>2</td></tr><tr><td>enumeration</td><td>3</td></tr><tr><td>enumeration</td><td>4</td></tr></tbody></table>	Kind	Value	pattern	[1-9]	enumeration	1	enumeration	2	enumeration	3	enumeration	4
Kind	Value												
pattern	[1-9]												
enumeration	1												
enumeration	2												
enumeration	3												
enumeration	4												

### simpleType **Tipo\_Reddito\_Da1a8\_Type**

namespace	urn:www.agenziaentrate.gov.it:specificheTecniche:sco:730																				
type	restriction of <a href="#">DatoNP_Type</a>																				
facets	<table><thead><tr><th>Kind</th><th>Value</th></tr></thead><tbody><tr><td>pattern</td><td>[1-9]{1}[0-9]*</td></tr><tr><td>enumeration</td><td>1</td></tr><tr><td>enumeration</td><td>2</td></tr><tr><td>enumeration</td><td>3</td></tr><tr><td>enumeration</td><td>4</td></tr><tr><td>enumeration</td><td>5</td></tr><tr><td>enumeration</td><td>6</td></tr><tr><td>enumeration</td><td>7</td></tr><tr><td>enumeration</td><td>8</td></tr></tbody></table>	Kind	Value	pattern	[1-9]{1}[0-9]*	enumeration	1	enumeration	2	enumeration	3	enumeration	4	enumeration	5	enumeration	6	enumeration	7	enumeration	8
Kind	Value																				
pattern	[1-9]{1}[0-9]*																				
enumeration	1																				
enumeration	2																				
enumeration	3																				
enumeration	4																				
enumeration	5																				
enumeration	6																				
enumeration	7																				
enumeration	8																				

### simpleType **Tipologia\_Soggetto\_Ass\_Fisc\_Type**

namespace	urn:www.agenziaentrate.gov.it:specificheTecniche:sco:730														
type	restriction of <a href="#">DatoN1_Type</a>														
facets	<table><thead><tr><th>Kind</th><th>Value</th></tr></thead><tbody><tr><td>pattern</td><td>[1-9]</td></tr><tr><td>enumeration</td><td>1</td></tr><tr><td>enumeration</td><td>2</td></tr><tr><td>enumeration</td><td>3</td></tr><tr><td>enumeration</td><td>4</td></tr><tr><td>enumeration</td><td>5</td></tr></tbody></table>	Kind	Value	pattern	[1-9]	enumeration	1	enumeration	2	enumeration	3	enumeration	4	enumeration	5
Kind	Value														
pattern	[1-9]														
enumeration	1														
enumeration	2														
enumeration	3														
enumeration	4														
enumeration	5														

### simpleType **Titolo\_Terreno\_Type**

namespace	urn:www.agenziaentrate.gov.it:specificheTecniche:sco:730																				
type	restriction of <a href="#">DatoNP_Type</a>																				
facets	<table><thead><tr><th>Kind</th><th>Value</th></tr></thead><tbody><tr><td>pattern</td><td>[1-9]{1}[0-9]*</td></tr><tr><td>enumeration</td><td>1</td></tr><tr><td>enumeration</td><td>2</td></tr><tr><td>enumeration</td><td>3</td></tr><tr><td>enumeration</td><td>4</td></tr><tr><td>enumeration</td><td>5</td></tr><tr><td>enumeration</td><td>6</td></tr><tr><td>enumeration</td><td>7</td></tr><tr><td>enumeration</td><td>10</td></tr></tbody></table>	Kind	Value	pattern	[1-9]{1}[0-9]*	enumeration	1	enumeration	2	enumeration	3	enumeration	4	enumeration	5	enumeration	6	enumeration	7	enumeration	10
Kind	Value																				
pattern	[1-9]{1}[0-9]*																				
enumeration	1																				
enumeration	2																				
enumeration	3																				
enumeration	4																				
enumeration	5																				
enumeration	6																				
enumeration	7																				
enumeration	10																				

### simpleType **Utilizzo\_Fabbricato\_Type**

namespace	urn:www.agenziaentrate.gov.it:specificheTecniche:sco:730
-----------	--

type	restriction of <a href="#">DatoNP_Type</a>	
facets	Kind	Value
	pattern	[1-9]{1}[0-9]*
	enumeration	1
	enumeration	2
	enumeration	3
	enumeration	4
	enumeration	5
	enumeration	8
	enumeration	9
	enumeration	10
	enumeration	11
	enumeration	12
	enumeration	14
	enumeration	15
	enumeration	16
	enumeration	17

### element Documento

diagram					
namespace	urn:www.agenziaentrate.gov.it:specificheTecniche:common				
type	<a href="#">Documento_Type</a>				
attributes	Name	Type	Use	Default	Fixed
	<a href="#">identificativo</a>	<a href="#">Identificativo_Type</a>	required		

### complexType Documento\_Type

diagram					
namespace	urn:www.agenziaentrate.gov.it:specificheTecniche:common				
attributes	Name	Type	Use	Default	Fixed
	<a href="#">identificativo</a>	<a href="#">Identificativo_Type</a>	required		

### attribute Documento\_Type/@identificativo

type	<a href="#">Identificativo_Type</a>	
facets	Kind	Value
	pattern	[0-9]{4}[1-9][0-9]{3}[1-9][0-9][0-9]{2}[1-9][0-9]{2}[0-9][1-9][0-9]{3}[1-9][0-9]{4}

### simpleType **Identificativo\_Type**

namespace	urn:www.agenziaentrate.gov.it:specificheTecniche:common
type	restriction of <b>xs:string</b>
facets	Kind Value pattern [0-9]{4}[1-9]  [0-9]{3}[1-9][0-9]  [0-9]{2}[1-9][0-9]{2}  [0-9][1-9][0-9]{3}  [1-9][0-9]{4}

### complexType **Dati\_Anagrafici\_Type**

diagram	
namespace	urn:www.agenziaentrate.gov.it:specificheTecniche:sco:common
children	<a href="#">Cognome</a> <a href="#">Nome</a> <a href="#">Sesso</a> <a href="#">DataNascita</a> <a href="#">ComuneNascita</a> <a href="#">ProvinciaNascita</a>

### element **Dati\_Anagrafici\_Type/Cognome**

diagram	
namespace	urn:www.agenziaentrate.gov.it:specificheTecniche:sco:common
type	<a href="#">DatoAN_Type</a>
facets	Kind Value pattern ([0-9A-Z\-\ ]&quot;){1}([ 0-9A-Z&amp; ; ' \- \., / ^ \^\(\\) À È É Ì Ò Ù Ú &quot; \\ / +)*

### element **Dati\_Anagrafici\_Type/Nome**

diagram	
namespace	urn:www.agenziaentrate.gov.it:specificheTecniche:sco:common
type	<a href="#">DatoAN_Type</a>
facets	Kind Value pattern ([0-9A-Z\-\ ]&quot;){1}([ 0-9A-Z&amp; ; ' \- \., / ^ \^\(\\) À È É Ì Ò Ù Ú &quot; \\ / +)*

### element **Dati\_Anagrafici\_Type/Sesso**

diagram	
---------	--

namespace	urn:www.agenziaentrate.gov.it:specificheTecniche:sco:common								
type	<a href="#">Sesso Type</a>								
facets	<table border="0"> <tr> <td>Kind</td> <td>Value</td> </tr> <tr> <td>pattern</td> <td>(([0-9A-Z-])&amp;quot;){1}([ 0-9A-Z&amp;amp;:] ' - \. / ° °\°\(\ )À É È Ì Ò Ù Û &amp;quot; \ \\ /+)*</td> </tr> <tr> <td>enumeration</td> <td>M</td> </tr> <tr> <td>enumeration</td> <td>F</td> </tr> </table>	Kind	Value	pattern	(([0-9A-Z-])&quot;){1}([ 0-9A-Z&amp;:] ' - \. / ° °\°\(\ )À É È Ì Ò Ù Û &quot; \ \\ /+)*	enumeration	M	enumeration	F
Kind	Value								
pattern	(([0-9A-Z-])&quot;){1}([ 0-9A-Z&amp;:] ' - \. / ° °\°\(\ )À É È Ì Ò Ù Û &quot; \ \\ /+)*								
enumeration	M								
enumeration	F								

#### element **Dati\_Anagrafici\_Type/DataNascita**

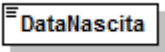
diagram					
namespace	urn:www.agenziaentrate.gov.it:specificheTecniche:sco:common				
type	<a href="#">DatoDT Type</a>				
facets	<table border="0"> <tr> <td>Kind</td> <td>Value</td> </tr> <tr> <td>pattern</td> <td>((([0-9]{1-9} [12][0-9]{3}[01])(0[13578][10 12](\d{4}))) ((([0][1-9] [12][0-9]{30}(0[469][11](\d{4}))) ((0[1-9] 1[0-9] 2[0-8])(02)(\d{4}))) ((29)(02)([02468][048]00)) ((29)(02)([13579][26]00)) ((29)(02)([0-9][0-9][0][48])) ((29)(02)([0-9][0-9][2468][048])) ((29)(02)([0-9][0-9][13579][26]))))</td> </tr> </table>	Kind	Value	pattern	((([0-9]{1-9} [12][0-9]{3}[01])(0[13578][10 12](\d{4}))) ((([0][1-9] [12][0-9]{30}(0[469][11](\d{4}))) ((0[1-9] 1[0-9] 2[0-8])(02)(\d{4}))) ((29)(02)([02468][048]00)) ((29)(02)([13579][26]00)) ((29)(02)([0-9][0-9][0][48])) ((29)(02)([0-9][0-9][2468][048])) ((29)(02)([0-9][0-9][13579][26]))))
Kind	Value				
pattern	((([0-9]{1-9} [12][0-9]{3}[01])(0[13578][10 12](\d{4}))) ((([0][1-9] [12][0-9]{30}(0[469][11](\d{4}))) ((0[1-9] 1[0-9] 2[0-8])(02)(\d{4}))) ((29)(02)([02468][048]00)) ((29)(02)([13579][26]00)) ((29)(02)([0-9][0-9][0][48])) ((29)(02)([0-9][0-9][2468][048])) ((29)(02)([0-9][0-9][13579][26]))))				

#### element **Dati\_Anagrafici\_Type/ComuneNascita**

diagram					
namespace	urn:www.agenziaentrate.gov.it:specificheTecniche:sco:common				
type	<a href="#">DatoAN Type</a>				
facets	<table border="0"> <tr> <td>Kind</td> <td>Value</td> </tr> <tr> <td>pattern</td> <td>(([0-9A-Z-])&amp;quot;){1}([ 0-9A-Z&amp;amp;:] ' - \. / ° °\°\(\ )À É È Ì Ò Ù Û &amp;quot; \ \\ /+)*</td> </tr> </table>	Kind	Value	pattern	(([0-9A-Z-])&quot;){1}([ 0-9A-Z&amp;:] ' - \. / ° °\°\(\ )À É È Ì Ò Ù Û &quot; \ \\ /+)*
Kind	Value				
pattern	(([0-9A-Z-])&quot;){1}([ 0-9A-Z&amp;:] ' - \. / ° °\°\(\ )À É È Ì Ò Ù Û &quot; \ \\ /+)*				

#### element **Dati\_Anagrafici\_Type/ProvinciaNascita**

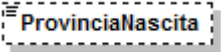
diagram	
namespace	urn:www.agenziaentrate.gov.it:specificheTecniche:sco:common
type	<a href="#">PN Type</a>



complexType **Dati\_Sottoscrittore\_Type**

diagram	
namespace	urn:www.agenziaentrate.gov.it:specificheTecniche:sco:common
children	<a href="#">CodiceFiscale</a> <a href="#">CodiceCarica</a> <a href="#">CodiceFiscaleSocieta</a> <a href="#">DatiAnagrafici</a> <a href="#">ResidenzaEstera</a> <a href="#">Telefono</a> <a href="#">DataCarica</a> <a href="#">InizioProcedura</a> <a href="#">ProceduraNonTerminata</a> <a href="#">FineProcedura</a>

element **Dati\_Sottoscrittore\_Type/CodiceFiscale**

diagram					
namespace	urn:www.agenziaentrate.gov.it:specificheTecniche:sco:common				
type	<a href="#">DatoCF_Type</a>				
facets	<table border="0"> <tr> <td>Kind</td> <td>Value</td> </tr> <tr> <td>pattern</td> <td>[0-9]{11}[A-Z]{6}[0-9LMNPQRSTUW]{2}[A-Z]{1}[0-9LMNPQRSTUW]{2}[A-Z]{1}[0-9LMNPQRSTUW]{3}[A-Z]{1}</td> </tr> </table>	Kind	Value	pattern	[0-9]{11}[A-Z]{6}[0-9LMNPQRSTUW]{2}[A-Z]{1}[0-9LMNPQRSTUW]{2}[A-Z]{1}[0-9LMNPQRSTUW]{3}[A-Z]{1}
Kind	Value				
pattern	[0-9]{11}[A-Z]{6}[0-9LMNPQRSTUW]{2}[A-Z]{1}[0-9LMNPQRSTUW]{2}[A-Z]{1}[0-9LMNPQRSTUW]{3}[A-Z]{1}				

element **Dati\_Sottoscrittore\_Type/CodiceCarica**

diagram																			
namespace	urn:www.agenziaentrate.gov.it:specificheTecniche:sco:common																		
type	<a href="#">Codice_Carica_Type</a>																		
facets	<table border="0"> <tr> <td>Kind</td> <td>Value</td> </tr> <tr> <td>pattern</td> <td>[1-9]{1}[0-9]*</td> </tr> <tr> <td>enumeration</td> <td>1</td> </tr> <tr> <td>enumeration</td> <td>2</td> </tr> <tr> <td>enumeration</td> <td>3</td> </tr> <tr> <td>enumeration</td> <td>4</td> </tr> <tr> <td>enumeration</td> <td>5</td> </tr> <tr> <td>enumeration</td> <td>6</td> </tr> <tr> <td>enumeration</td> <td>7</td> </tr> </table>	Kind	Value	pattern	[1-9]{1}[0-9]*	enumeration	1	enumeration	2	enumeration	3	enumeration	4	enumeration	5	enumeration	6	enumeration	7
Kind	Value																		
pattern	[1-9]{1}[0-9]*																		
enumeration	1																		
enumeration	2																		
enumeration	3																		
enumeration	4																		
enumeration	5																		
enumeration	6																		
enumeration	7																		

	enumeration	8
	enumeration	9
	enumeration	10
	enumeration	11
	enumeration	12
	enumeration	13
	enumeration	14
	enumeration	15

**element Dati\_Sottoscrittore\_Type/CodiceFiscaleSocieta**

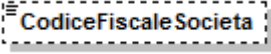
diagram		
namespace	urn:www.agenziaentrate.gov.it:specificheTecniche:sco:common	
type	<a href="#">DatoCN_Type</a>	
facets	Kind	Value
	pattern	[0-9]{11}

**element Dati\_Sottoscrittore\_Type/DatiAnagrafici**

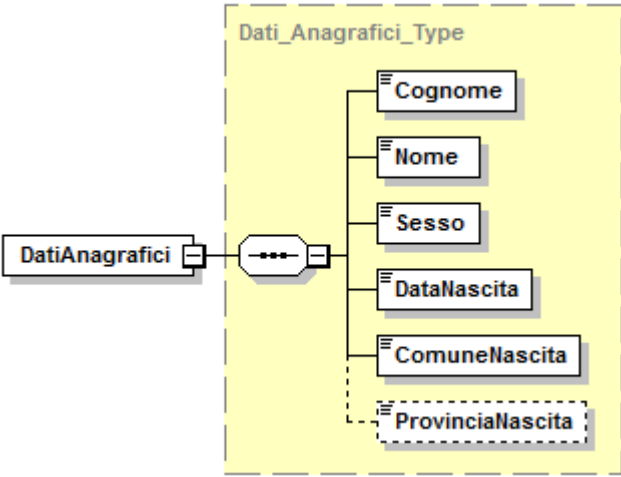
diagram		
namespace	urn:www.agenziaentrate.gov.it:specificheTecniche:sco:common	
type	<a href="#">Dati_Anagrafici_Type</a>	
children	<a href="#">Cognome</a> <a href="#">Nome</a> <a href="#">Sesso</a> <a href="#">DataNascita</a> <a href="#">ComuneNascita</a> <a href="#">ProvinciaNascita</a>	

element **Dati\_Sottoscrittore\_Type/ResidenzaEstera**

diagram	
namespace	urn:www.agenziaentrate.gov.it:specificheTecniche:sco:common
type	<a href="#">Residenza_Estera_Type</a>
children	<a href="#">CodiceStatoEstero</a> <a href="#">StatoFederato</a> <a href="#">LocalitaEstero</a> <a href="#">IndirizzoEstero</a>

element **Dati\_Sottoscrittore\_Type/Telefono**

diagram					
namespace	urn:www.agenziaentrate.gov.it:specificheTecniche:sco:common				
type	<a href="#">DatoTL_Type</a>				
facets	<table border="1"> <thead> <tr> <th>Kind</th> <th>Value</th> </tr> </thead> <tbody> <tr> <td>pattern</td> <td>[0-9]*</td> </tr> </tbody> </table>	Kind	Value	pattern	[0-9]*
Kind	Value				
pattern	[0-9]*				

element **Dati\_Sottoscrittore\_Type/DataCarica**

diagram					
namespace	urn:www.agenziaentrate.gov.it:specificheTecniche:sco:common				
type	<a href="#">DatoDT_Type</a>				
facets	<table border="1"> <thead> <tr> <th>Kind</th> <th>Value</th> </tr> </thead> <tbody> <tr> <td>pattern</td> <td>((([0-9]{1,2}[0-9]{3,4}) (0[13578][10]12\d{4})) ((([0-9]{1,2}[0-9]{3,4}) (0[469][11]\d{4})) ((([0-9]{1,2}[0-9]{2,3}) (29)(02)([02468][048]00)) ((29)(02)([13579][26]00)) ((29)(02)([0-9][0][48])) ((29)(02)([0-9][0-9][2468][048])) ((29)(02)([0-9][0-9][13579][26])))))</td> </tr> </tbody> </table>	Kind	Value	pattern	((([0-9]{1,2}[0-9]{3,4}) (0[13578][10]12\d{4})) ((([0-9]{1,2}[0-9]{3,4}) (0[469][11]\d{4})) ((([0-9]{1,2}[0-9]{2,3}) (29)(02)([02468][048]00)) ((29)(02)([13579][26]00)) ((29)(02)([0-9][0][48])) ((29)(02)([0-9][0-9][2468][048])) ((29)(02)([0-9][0-9][13579][26])))))
Kind	Value				
pattern	((([0-9]{1,2}[0-9]{3,4}) (0[13578][10]12\d{4})) ((([0-9]{1,2}[0-9]{3,4}) (0[469][11]\d{4})) ((([0-9]{1,2}[0-9]{2,3}) (29)(02)([02468][048]00)) ((29)(02)([13579][26]00)) ((29)(02)([0-9][0][48])) ((29)(02)([0-9][0-9][2468][048])) ((29)(02)([0-9][0-9][13579][26])))))				

element **Dati\_Sottoscrittore\_Type/InizioProcedura**

diagram					
namespace	urn:www.agenziaentrate.gov.it:specificheTecniche:sco:common				
type	<a href="#">DatoDT_Type</a>				
facets	<table border="1"> <thead> <tr> <th>Kind</th> <th>Value</th> </tr> </thead> <tbody> <tr> <td>pattern</td> <td>((([0-9]{1,2}[0-9]{3,4}) (0[13578][10]12\d{4})) ((([0-9]{1,2}[0-9]{3,4}) (0[469][11]\d{4})) ((([0-9]{1,2}[0-9]{2,3}) (29)(02)([02468][048]00)) ((29)(02)([13579][26]00)) ((29)(02)([0-9][0][48])) ((29)(02)([0-9][0-9][2468][048])) ((29)(02)([0-9][0-9][13579][26])))))</td> </tr> </tbody> </table>	Kind	Value	pattern	((([0-9]{1,2}[0-9]{3,4}) (0[13578][10]12\d{4})) ((([0-9]{1,2}[0-9]{3,4}) (0[469][11]\d{4})) ((([0-9]{1,2}[0-9]{2,3}) (29)(02)([02468][048]00)) ((29)(02)([13579][26]00)) ((29)(02)([0-9][0][48])) ((29)(02)([0-9][0-9][2468][048])) ((29)(02)([0-9][0-9][13579][26])))))
Kind	Value				
pattern	((([0-9]{1,2}[0-9]{3,4}) (0[13578][10]12\d{4})) ((([0-9]{1,2}[0-9]{3,4}) (0[469][11]\d{4})) ((([0-9]{1,2}[0-9]{2,3}) (29)(02)([02468][048]00)) ((29)(02)([13579][26]00)) ((29)(02)([0-9][0][48])) ((29)(02)([0-9][0-9][2468][048])) ((29)(02)([0-9][0-9][13579][26])))))				

element **Dati\_Sottoscrittore\_Type/ProceduraNonTerminata**

diagram	
namespace	urn:www.agenziaentrate.gov.it:specificheTecniche:sco:common
type	<a href="#">DatoCB_Type</a>
facets	Kind Value pattern [01]

element **Dati\_Sottoscrittore\_Type/FineProcedura**

diagram	
namespace	urn:www.agenziaentrate.gov.it:specificheTecniche:sco:common
type	<a href="#">DatoDT_Type</a>
facets	Kind Value pattern ((([0-9]{12}[0-9]{3}[01])(0[13578][1012](\d{4})) ([0-9]{12}[0-9]{30}(0[469][11](\d{4})) ([0-9]{11}[0-9]{2}[0-8])(02)(\d{4})) ((29)(02)[02468][048]00) ((29)(02)[13579][26]00) ((29)(02)[0-9][0-9][0][48]) ((29)(02)[0-9][0-9][2468][048]) ((29)(02)[0-9][0-9][13579][26]))))

complexType **Domicilio\_EE\_Type**

diagram	
namespace	urn:www.agenziaentrate.gov.it:specificheTecniche:sco:common
children	<a href="#">Comune</a> <a href="#">Provincia</a> <a href="#">CodiceComune</a> <a href="#">Indirizzo</a> <a href="#">Cap</a> <a href="#">DataVariazione</a>

element **Domicilio\_EE\_Type/Comune**

diagram	
namespace	urn:www.agenziaentrate.gov.it:specificheTecniche:sco:common
type	<a href="#">DatoAN_Type</a>
facets	Kind Value

pattern	(([0-9A-Z\-\ ]&quot;){1}([ 0-9A-Z&amp;#92; \-\.\, / ^ \^\(\ \)\ À É È Ì Ò Ù Û &quot; \ \ \ +)*
---------	--

#### element Domicilio\_EE\_Type/Provincia

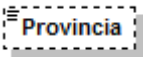
diagram	
namespace	urn:www.agenziaentrate.gov.it:specificheTecniche:sco:common
type	<a href="#">PE_Type</a>

#### element Domicilio\_EE\_Type/CodiceComune

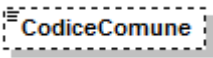
diagram	
namespace	urn:www.agenziaentrate.gov.it:specificheTecniche:sco:common
type	<a href="#">DatoAN_Type</a>
facets	Kind Value pattern (([0-9A-Z\-\ ]&quot;){1}([ 0-9A-Z&amp;#92; \-\.\, / ^ \^\(\ \)\ À É È Ì Ò Ù Û &quot; \ \ \ +)*

#### element Domicilio\_EE\_Type/Indirizzo

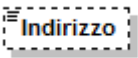
diagram	
namespace	urn:www.agenziaentrate.gov.it:specificheTecniche:sco:common
type	<a href="#">DatoAN_Type</a>
facets	Kind Value pattern (([0-9A-Z\-\ ]&quot;){1}([ 0-9A-Z&amp;#92; \-\.\, / ^ \^\(\ \)\ À É È Ì Ò Ù Û &quot; \ \ \ +)*

#### element Domicilio\_EE\_Type/Cap

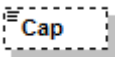
diagram	
namespace	urn:www.agenziaentrate.gov.it:specificheTecniche:sco:common
type	<a href="#">DatoCP_Type</a>
facets	Kind Value pattern [0-9]{5}

#### element Domicilio\_EE\_Type/DataVariazione

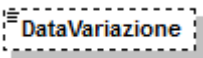
diagram	
namespace	urn:www.agenziaentrate.gov.it:specificheTecniche:sco:common
type	<a href="#">DatoD6_Type</a>
facets	Kind Value pattern (([0-9])([10-2]))((19 20)[0-9][0-9])

complexType **Domicilio\_Fiscale\_Type**

diagram	
namespace	urn:www.agenziaentrate.gov.it:specificheTecniche:sco:common
type	extension of <a href="#">Domicilio_Ita_Type</a>
children	<a href="#">Comune</a> <a href="#">Provincia</a> <a href="#">CodiceComune</a> <a href="#">Indirizzo</a> <a href="#">Cap</a> <a href="#">DataVariazione</a>

element **Domicilio\_Fiscale\_Type/DataVariazione**

diagram					
namespace	urn:www.agenziaentrate.gov.it:specificheTecniche:sco:common				
type	<a href="#">DatoD6_Type</a>				
facets	<table border="0"> <tr> <td>Kind</td> <td>Value</td> </tr> <tr> <td>pattern</td> <td>((0[0-9]) (1[0-2]))((19 20)[0-9][0-9])</td> </tr> </table>	Kind	Value	pattern	((0[0-9]) (1[0-2]))((19 20)[0-9][0-9])
Kind	Value				
pattern	((0[0-9]) (1[0-2]))((19 20)[0-9][0-9])				

complexType **Domicilio\_Ita\_Type**

diagram	
namespace	urn:www.agenziaentrate.gov.it:specificheTecniche:sco:common
children	<a href="#">Comune</a> <a href="#">Provincia</a> <a href="#">CodiceComune</a> <a href="#">Indirizzo</a> <a href="#">Cap</a>

element **Domicilio\_Ita\_Type/Comune**

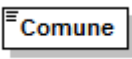
diagram	
namespace	urn:www.agenziaentrate.gov.it:specificheTecniche:sco:common
type	<a href="#">DatoAN_Type</a>
facets	Kind Value pattern ([0-9A-Z-]*)&quot;}{1}([ 0-9A-Z&amp;:] ' - \., / ^ ^\(\ \)\ À É È Ì Ò Ù Û &quot; \\ / +)*

element **Domicilio\_Ita\_Type/Provincia**

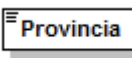
diagram	
namespace	urn:www.agenziaentrate.gov.it:specificheTecniche:sco:common
type	<a href="#">PR_Type</a>

element **Domicilio\_Ita\_Type/CodiceComune**

diagram	
namespace	urn:www.agenziaentrate.gov.it:specificheTecniche:sco:common
type	<a href="#">DatoAN_Type</a>
facets	Kind Value pattern ([0-9A-Z-]*)&quot;}{1}([ 0-9A-Z&amp;:] ' - \., / ^ ^\(\ \)\ À É È Ì Ò Ù Û &quot; \\ / +)*

element **Domicilio\_Ita\_Type/Indirizzo**

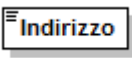
diagram	
namespace	urn:www.agenziaentrate.gov.it:specificheTecniche:sco:common
type	<a href="#">DatoAN_Type</a>
facets	Kind Value pattern ([0-9A-Z-]*)&quot;}{1}([ 0-9A-Z&amp;:] ' - \., / ^ ^\(\ \)\ À É È Ì Ò Ù Û &quot; \\ / +)*

element **Domicilio\_Ita\_Type/Cap**

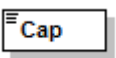
diagram	
namespace	urn:www.agenziaentrate.gov.it:specificheTecniche:sco:common
type	<a href="#">DatoCP_Type</a>
facets	Kind Value pattern [0-9]{5}

### complexType Firma\_Revisione\_Type

diagram	
namespace	urn:www.agenziaentrate.gov.it:specificheTecniche:sco:common
children	<a href="#">Soggetto</a> <a href="#">CodiceFiscale</a> <a href="#">FirmaDichiarante</a>

### element Firma\_Revisione\_Type/Soggetto

diagram					
namespace	urn:www.agenziaentrate.gov.it:specificheTecniche:sco:common				
type	restriction of <a href="#">DatoNP_Type</a>				
facets	<table border="1"> <tr> <td>Kind</td> <td>Value</td> </tr> <tr> <td>pattern</td> <td>[1-4]</td> </tr> </table>	Kind	Value	pattern	[1-4]
Kind	Value				
pattern	[1-4]				

### element Firma\_Revisione\_Type/CodiceFiscale

diagram					
namespace	urn:www.agenziaentrate.gov.it:specificheTecniche:sco:common				
type	<a href="#">DatoCF_Type</a>				
facets	<table border="1"> <tr> <td>Kind</td> <td>Value</td> </tr> <tr> <td>pattern</td> <td>[0-9]{1}[A-Z]{6}[0-9LMNPQRSTU]{2}[A-Z]{1}[0-9LMNPQRSTU]{2}[A-Z]{1}[0-9LMNPQRSTU]{3}[A-Z]{1}</td> </tr> </table>	Kind	Value	pattern	[0-9]{1}[A-Z]{6}[0-9LMNPQRSTU]{2}[A-Z]{1}[0-9LMNPQRSTU]{2}[A-Z]{1}[0-9LMNPQRSTU]{3}[A-Z]{1}
Kind	Value				
pattern	[0-9]{1}[A-Z]{6}[0-9LMNPQRSTU]{2}[A-Z]{1}[0-9LMNPQRSTU]{2}[A-Z]{1}[0-9LMNPQRSTU]{3}[A-Z]{1}				

### element Firma\_Revisione\_Type/FirmaDichiarante

diagram					
namespace	urn:www.agenziaentrate.gov.it:specificheTecniche:sco:common				
type	<a href="#">DatoCB_Type</a>				
facets	<table border="1"> <tr> <td>Kind</td> <td>Value</td> </tr> <tr> <td>pattern</td> <td>[01]</td> </tr> </table>	Kind	Value	pattern	[01]
Kind	Value				
pattern	[01]				

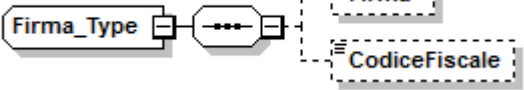

### complexType Firma\_Type

diagram	
namespace	urn:www.agenziaentrate.gov.it:specificheTecniche:sco:common
children	<a href="#">Firma</a> <a href="#">CodiceFiscale</a>

### element Firma\_Type/Firma

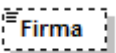
diagram	
namespace	urn:www.agenziaentrate.gov.it:specificheTecniche:sco:common
type	<a href="#">DatoCB_Type</a>
facets	Kind Value pattern [01]

### element Firma\_Type/CodiceFiscale

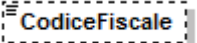
diagram	
namespace	urn:www.agenziaentrate.gov.it:specificheTecniche:sco:common
type	restriction of <b>xs:string</b>
facets	Kind Value pattern ([0-9A-Z-] \&quot;){0,1}([0-9A-Z&amp;#39;] ' \" \" _ s / ° \" \" \" À È É Ì Ò Ù Û &quot; \\ / +)*

### complexType Frontespizio\_Type

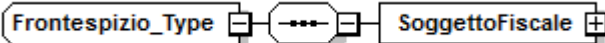
diagram	
namespace	urn:www.agenziaentrate.gov.it:specificheTecniche:sco:common
children	<a href="#">SoggettoFiscale</a>

element **Frontespizio\_Type/SoggettoFiscale**

diagram	
namespace	urn:www.agenziaentrate.gov.it:specificheTecniche:sco:common
type	<a href="#">Soggetto_Fiscale_Type</a>
children	<a href="#">CodiceFiscale</a> <a href="#">Email</a> <a href="#">Telefono</a> <a href="#">Fax</a>

complexType **Impegno\_A\_Trasmettere\_Type**

diagram	
namespace	urn:www.agenziaentrate.gov.it:specificheTecniche:sco:common
children	<a href="#">CFintermediario</a> <a href="#">NumerolscrAlboCAF</a> <a href="#">ImpegnoATrasmettere</a> <a href="#">RicezioneAvvisoTelem</a> <a href="#">DataImpegno</a> <a href="#">FirmaIntermediario</a>

element **Impegno\_A\_Trasmettere\_Type/CFintermediario**

diagram					
namespace	urn:www.agenziaentrate.gov.it:specificheTecniche:sco:common				
type	<a href="#">DatoCF_Type</a>				
facets	<table border="1"> <thead> <tr> <th>Kind</th> <th>Value</th> </tr> </thead> <tbody> <tr> <td>pattern</td> <td>[0-9]{11}[A-Z]{6}[0-9LMNPQRSTU]{2}[A-Z]{1}[0-9LMNPQRSTU]{2}[A-Z]{1}[0-9LMNPQRSTU]{3}[A-Z]{1}</td> </tr> </tbody> </table>	Kind	Value	pattern	[0-9]{11}[A-Z]{6}[0-9LMNPQRSTU]{2}[A-Z]{1}[0-9LMNPQRSTU]{2}[A-Z]{1}[0-9LMNPQRSTU]{3}[A-Z]{1}
Kind	Value				
pattern	[0-9]{11}[A-Z]{6}[0-9LMNPQRSTU]{2}[A-Z]{1}[0-9LMNPQRSTU]{2}[A-Z]{1}[0-9LMNPQRSTU]{3}[A-Z]{1}				

element **Impegno\_A\_Trasmettere\_Type/NumerolscrAlboCAF**

diagram	
namespace	urn:www.agenziaentrate.gov.it:specificheTecniche:sco:common
type	restriction of <a href="#">DatoNU_Type</a>
facets	Kind Value pattern $(\{-[1-9]\}[1-9])[0-9]^*$

element **Impegno\_A\_Trasmettere\_Type/ImpegnoATrasmettere**

diagram	
namespace	urn:www.agenziaentrate.gov.it:specificheTecniche:sco:common
type	restriction of <a href="#">DatoNP_Type</a>
facets	Kind Value pattern 1 2 enumeration 1 enumeration 2

element **Impegno\_A\_Trasmettere\_Type/RicezioneAvvisoTelem**

diagram	
namespace	urn:www.agenziaentrate.gov.it:specificheTecniche:sco:common
type	<a href="#">DatoCB_Type</a>
facets	Kind Value pattern [01]

element **Impegno\_A\_Trasmettere\_Type/Datalimpegno**

diagram	
namespace	urn:www.agenziaentrate.gov.it:specificheTecniche:sco:common
type	<a href="#">DatoDT_Type</a>
facets	Kind Value pattern $((([0-9][1-9][12][0-9][301])([013578][1012](\d{4})))([([0][1-9][12][0-9][30](0[469][11](\d{4})))([0[1-9][1[0-9][2[0-8])(02)(\d{4})))([29](02)([02468][048]00)]([29](02)([13579][26]00))([29](02)([0-9][0-9][0][48]))([29](02)([0-9][0-9][2468][048]))([29](02)([0-9][0-9][13579][26]))))$

element **Impegno\_A\_Trasmettere\_Type/FirmaIntermediario**

diagram	
namespace	urn:www.agenziaentrate.gov.it:specificheTecniche:sco:common
type	<a href="#">DatoCB_Type</a>

facets	Kind pattern	Value [01]
--------	-----------------	---------------

### complexType **Persone\_Fisiche\_Type**

diagram	
namespace	urn:www.agenziaentrate.gov.it:specificheTecniche:sco:common
children	<a href="#">DatiAnagrafici</a> <a href="#">ResidenzaAnagrafica</a>

### element **Persone\_Fisiche\_Type/DatiAnagrafici**

diagram	
namespace	urn:www.agenziaentrate.gov.it:specificheTecniche:sco:common
type	<a href="#">Dati_Anagrafici_Type</a>
children	<a href="#">Cognome</a> <a href="#">Nome</a> <a href="#">Sesso</a> <a href="#">DataNascita</a> <a href="#">ComuneNascita</a> <a href="#">ProvinciaNascita</a>

element **Persone\_Fisiche\_Type/ResidenzaAnagrafica**

diagram	
namespace	urn:www.agenziaentrate.gov.it:specificheTecniche:sco:common
type	<a href="#">Residenza_Anagrafica_Type</a>
children	<a href="#">Comune</a> <a href="#">Provincia</a> <a href="#">CodiceComune</a> <a href="#">Indirizzo</a> <a href="#">Cap</a> <a href="#">DataVariazione</a>

complexType **Residenza\_Anagrafica\_Type**

diagram	
namespace	urn:www.agenziaentrate.gov.it:specificheTecniche:sco:common
type	extension of <a href="#">Domicilio_Ita_Type</a>
children	<a href="#">Comune</a> <a href="#">Provincia</a> <a href="#">CodiceComune</a> <a href="#">Indirizzo</a> <a href="#">Cap</a> <a href="#">DataVariazione</a>

element **Residenza\_Anagrafica\_Type/DataVariazione**

diagram	
---------	--

namespace	urn:www.agenziaentrate.gov.it:specificheTecniche:sco:common				
type	<a href="#">DatoDT_Type</a>				
facets	<table border="1"> <thead> <tr> <th>Kind</th> <th>Value</th> </tr> </thead> <tbody> <tr> <td>pattern</td> <td>((([0-9][1-9][12][0-9][301])(0[13578][1012]\d{4})) ((([0][1-9][12][0-9][30])(0[469][11]\d{4})) ((([0][1-9][1][0-9][2][0-8])(02)\d{4})) ((29)(02)([02468][048]00)) ((29)(02)([13579][26]00)) ((29)(02)([0-9][0][48])) ((29)(02)([0-9][0-9][2468][048])) ((29)(02)([0-9][0-9][13579][26]))))</td> </tr> </tbody> </table>	Kind	Value	pattern	((([0-9][1-9][12][0-9][301])(0[13578][1012]\d{4})) ((([0][1-9][12][0-9][30])(0[469][11]\d{4})) ((([0][1-9][1][0-9][2][0-8])(02)\d{4})) ((29)(02)([02468][048]00)) ((29)(02)([13579][26]00)) ((29)(02)([0-9][0][48])) ((29)(02)([0-9][0-9][2468][048])) ((29)(02)([0-9][0-9][13579][26]))))
Kind	Value				
pattern	((([0-9][1-9][12][0-9][301])(0[13578][1012]\d{4})) ((([0][1-9][12][0-9][30])(0[469][11]\d{4})) ((([0][1-9][1][0-9][2][0-8])(02)\d{4})) ((29)(02)([02468][048]00)) ((29)(02)([13579][26]00)) ((29)(02)([0-9][0][48])) ((29)(02)([0-9][0-9][2468][048])) ((29)(02)([0-9][0-9][13579][26]))))				

### complexType **Residenza\_Estera\_Type**

diagram	
namespace	urn:www.agenziaentrate.gov.it:specificheTecniche:sco:common
children	<a href="#">CodiceStatoEstero</a> <a href="#">StatoFederato</a> <a href="#">LocalitaEstero</a> <a href="#">IndirizzoEstero</a>

### element **Residenza\_Estera\_Type/CodiceStatoEstero**

diagram					
namespace	urn:www.agenziaentrate.gov.it:specificheTecniche:sco:common				
type	restriction of <a href="#">DatoAN_Type</a>				
facets	<table border="1"> <thead> <tr> <th>Kind</th> <th>Value</th> </tr> </thead> <tbody> <tr> <td>pattern</td> <td>([0-9A-Z-] \&amp;quot;){1}([ 0-9A-Z&amp;amp;:] \- \., / ^ \^\(\ \)\ À È É Ì Ò Ù Û &amp;quot; \ \\ \ +)*</td> </tr> </tbody> </table>	Kind	Value	pattern	([0-9A-Z-] \&quot;){1}([ 0-9A-Z&amp;:] \- \., / ^ \^\(\ \)\ À È É Ì Ò Ù Û &quot; \ \\ \ +)*
Kind	Value				
pattern	([0-9A-Z-] \&quot;){1}([ 0-9A-Z&amp;:] \- \., / ^ \^\(\ \)\ À È É Ì Ò Ù Û &quot; \ \\ \ +)*				

### element **Residenza\_Estera\_Type/StatoFederato**

diagram					
namespace	urn:www.agenziaentrate.gov.it:specificheTecniche:sco:common				
type	restriction of <a href="#">DatoAN_Type</a>				
facets	<table border="1"> <thead> <tr> <th>Kind</th> <th>Value</th> </tr> </thead> <tbody> <tr> <td>pattern</td> <td>([0-9A-Z-] \&amp;quot;){1}([ 0-9A-Z&amp;amp;:] \- \., / ^ \^\(\ \)\ À È É Ì Ò Ù Û &amp;quot; \ \\ \ +)*</td> </tr> </tbody> </table>	Kind	Value	pattern	([0-9A-Z-] \&quot;){1}([ 0-9A-Z&amp;:] \- \., / ^ \^\(\ \)\ À È É Ì Ò Ù Û &quot; \ \\ \ +)*
Kind	Value				
pattern	([0-9A-Z-] \&quot;){1}([ 0-9A-Z&amp;:] \- \., / ^ \^\(\ \)\ À È É Ì Ò Ù Û &quot; \ \\ \ +)*				

### element **Residenza\_Estera\_Type/LocalitaEstero**

diagram	
namespace	urn:www.agenziaentrate.gov.it:specificheTecniche:sco:common
type	<a href="#">DatoAN_Type</a>

facets	Kind	Value
	pattern	(([0-9A-Z-] \&quot;){1}([ 0-9A-Z&amp;#39; " - \., / "^\(\)\) À É È Ì Ò Ù Ü &quot; \ \\ \ +)*

element **Residenza\_Estera\_Type/IndirizzoEstero**

diagram	
namespace	urn:www.agenziaentrate.gov.it:specificheTecniche:sco:common
type	<a href="#">DatoAN_Type</a>
facets	Kind Value pattern (([0-9A-Z-] \&quot;){1}([ 0-9A-Z&amp;#39; " - \., / "^\(\)\) À É È Ì Ò Ù Ü &quot; \ \\ \ +)*

complexType **Soggetti\_Diversi\_Da\_PF\_Type**

diagram	
namespace	urn:www.agenziaentrate.gov.it:specificheTecniche:sco:common
children	<a href="#">Denominazione</a> <a href="#">SedeLegale</a> <a href="#">DomicilioFiscale</a> <a href="#">DataApprovazioneBilancio</a> <a href="#">TermineApprovazioneBilancio</a> <a href="#">InizioPeriodoImposta</a> <a href="#">FinePeriodoImposta</a> <a href="#">Stato</a> <a href="#">NaturaGiuridica</a> <a href="#">Situazione</a>

element **Soggetti\_Diversi\_Da\_PF\_Type/Denominazione**

diagram	
namespace	urn:www.agenziaentrate.gov.it:specificheTecniche:sco:common
type	<a href="#">DatoAN_Type</a>
facets	Kind Value pattern (([0-9A-Z-] \&quot;){1}([ 0-9A-Z&amp;#39; " - \., / "^\(\)\) À É È Ì Ò Ù Ü &quot; \ \\ \ +)*

element **Soggetti\_Diversi\_Da\_PF\_Type/SedeLegale**

diagram	
namespace	urn:www.agenziaentrate.gov.it:specificheTecniche:sco:common
type	<a href="#">Domicilio EE Type</a>
children	<a href="#">Comune</a> <a href="#">Provincia</a> <a href="#">CodiceComune</a> <a href="#">Indirizzo</a> <a href="#">Cap</a> <a href="#">DataVariazione</a>

element **Soggetti\_Diversi\_Da\_PF\_Type/DomicilioFiscale**

diagram	
namespace	urn:www.agenziaentrate.gov.it:specificheTecniche:sco:common
type	<a href="#">Domicilio Fiscale Type</a>
children	<a href="#">Comune</a> <a href="#">Provincia</a> <a href="#">CodiceComune</a> <a href="#">Indirizzo</a> <a href="#">Cap</a> <a href="#">DataVariazione</a>

element **Soggetti\_Diversi\_Da\_PF\_Type/DataApprovazioneBilancio**

diagram	
---------	--





pattern	[1-9]{1}[0-9]*
enumeration	1
enumeration	2
enumeration	3
enumeration	4

element **Soggetti\_Diversi\_Da\_PF\_Type/NaturaGiuridica**

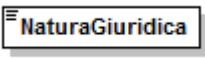
diagram		
namespace	urn:www.agenziaentrate.gov.it:specificheTecniche:sco:common	
type	<a href="#">Natura Giuridica Type</a>	
facets	Kind	Value
	pattern	[1-9]{1}[0-9]*
	enumeration	1
	enumeration	2
	enumeration	3
	enumeration	4
	enumeration	5
	enumeration	6
	enumeration	7
	enumeration	8
	enumeration	9
	enumeration	10
	enumeration	11
	enumeration	12
	enumeration	13
	enumeration	14
	enumeration	15
	enumeration	16
	enumeration	17
	enumeration	18
	enumeration	19
	enumeration	20
	enumeration	21
	enumeration	22
	enumeration	23
	enumeration	24
	enumeration	25
	enumeration	26
	enumeration	27
	enumeration	28
	enumeration	29
	enumeration	30
	enumeration	31
	enumeration	32
	enumeration	33
	enumeration	34
	enumeration	35
	enumeration	36
	enumeration	37
	enumeration	38
	enumeration	39
	enumeration	40
	enumeration	41
	enumeration	42
	enumeration	43
	enumeration	44
	enumeration	45
	enumeration	50
	enumeration	51
	enumeration	52
	enumeration	53

	enumeration	54
	enumeration	55
	enumeration	56
	enumeration	57
	enumeration	58
	enumeration	59

### element **Soggetti\_Diversi\_Da\_PF\_Type/Situazione**

diagram																			
namespace	urn:www.agenziaentrate.gov.it:specificheTecniche:sco:common																		
type	<a href="#">Situazione_Type</a>																		
facets	<table border="1"> <thead> <tr> <th>Kind</th> <th>Value</th> </tr> </thead> <tbody> <tr> <td>pattern</td> <td>[1-9]{1}[0-9]*</td> </tr> <tr> <td>enumeration</td> <td>1</td> </tr> <tr> <td>enumeration</td> <td>2</td> </tr> <tr> <td>enumeration</td> <td>3</td> </tr> <tr> <td>enumeration</td> <td>4</td> </tr> <tr> <td>enumeration</td> <td>5</td> </tr> <tr> <td>enumeration</td> <td>6</td> </tr> <tr> <td>enumeration</td> <td>7</td> </tr> </tbody> </table>	Kind	Value	pattern	[1-9]{1}[0-9]*	enumeration	1	enumeration	2	enumeration	3	enumeration	4	enumeration	5	enumeration	6	enumeration	7
Kind	Value																		
pattern	[1-9]{1}[0-9]*																		
enumeration	1																		
enumeration	2																		
enumeration	3																		
enumeration	4																		
enumeration	5																		
enumeration	6																		
enumeration	7																		

### complexType **Soggetti\_Non\_Residenti\_Type**

diagram	
namespace	urn:www.agenziaentrate.gov.it:specificheTecniche:sco:common
children	<a href="#">StatoEsteroResidenza</a> <a href="#">CodiceStatoEstero</a> <a href="#">CodiceIdentificazioneEstero</a>

### element **Soggetti\_Non\_Residenti\_Type/StatoEsteroResidenza**

diagram					
namespace	urn:www.agenziaentrate.gov.it:specificheTecniche:sco:common				
type	<a href="#">DatoAN_Type</a>				
facets	<table border="1"> <thead> <tr> <th>Kind</th> <th>Value</th> </tr> </thead> <tbody> <tr> <td>pattern</td> <td>([0-9A-Z- &amp;quot;}{1}{[ 0-9A-Z&amp;amp;] ' ~ \., / ° ^\(\ \)À È É Ì Ò Ù Û &amp;quot; \ \\ /+)*</td> </tr> </tbody> </table>	Kind	Value	pattern	([0-9A-Z- &quot;}{1}{[ 0-9A-Z&amp;] ' ~ \., / ° ^\(\ \)À È É Ì Ò Ù Û &quot; \ \\ /+)*
Kind	Value				
pattern	([0-9A-Z- &quot;}{1}{[ 0-9A-Z&amp;] ' ~ \., / ° ^\(\ \)À È É Ì Ò Ù Û &quot; \ \\ /+)*				

### element **Soggetti\_Non\_Residenti\_Type/CodiceStatoEstero**

diagram	
namespace	urn:www.agenziaentrate.gov.it:specificheTecniche:sco:common

type	<a href="#">DatoAN_Type</a>
facets	Kind Value pattern ([0-9A-Z-]*)&quot;}{1}([ 0-9A-Z&amp;:] ' - \., / ^ \^\(\ \)\ À È É Ì Ò Ù Û &quot; \ \\ \ +)*

element **Soggetti\_Non\_Residenti\_Type/CodicelIdentificazioneEestero**

diagram	
namespace	urn:www.agenziaentrate.gov.it:specificheTecniche:sco:common
type	<a href="#">DatoAN_Type</a>
facets	Kind Value pattern ([0-9A-Z-]*)&quot;}{1}([ 0-9A-Z&amp;:] ' - \., / ^ \^\(\ \)\ À È É Ì Ò Ù Û &quot; \ \\ \ +)*

complexType **Soggetto\_Fiscale\_Type**

diagram	
namespace	urn:www.agenziaentrate.gov.it:specificheTecniche:sco:common
children	<a href="#">CodiceFiscale</a> <a href="#">Email</a> <a href="#">Telefono</a> <a href="#">Fax</a>

element **Soggetto\_Fiscale\_Type/CodiceFiscale**

diagram	
namespace	urn:www.agenziaentrate.gov.it:specificheTecniche:sco:common
type	<a href="#">DatoCF_Type</a>
facets	Kind Value pattern [0-9]{11}[A-Z]{6}[0-9LMNPQRSTUUV]{2}[A-Z]{1}[0-9LMNPQRSTUUV]{2}[A-Z]{1}[0-9LMNPQRSTUUV]{3}[A-Z]{1}

element **Soggetto\_Fiscale\_Type/Email**

diagram	
namespace	urn:www.agenziaentrate.gov.it:specificheTecniche:sco:common
type	<a href="#">DatoEM_Type</a>
facets	Kind Value pattern [a-zA-Z0-9_%.&quot;?^~=&#x2D;]+@[a-zA-Z0-9.\-]+\.[a-zA-Z]{2,4}

element **Soggetto\_Fiscale\_Type/Telefono**

diagram	
namespace	urn:www.agenziaentrate.gov.it:specificheTecniche:sco:common
type	<a href="#">DatoTL_Type</a>
facets	Kind Value pattern [0-9]*

element **Soggetto\_Fiscale\_Type/Fax**

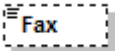
diagram	
namespace	urn:www.agenziaentrate.gov.it:specificheTecniche:sco:common
type	<a href="#">DatoTL_Type</a>
facets	Kind Value pattern [0-9]*

complexType **Tipo\_Dichiarazione\_Type**

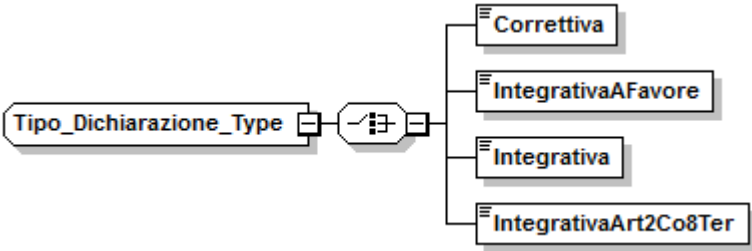
diagram	
namespace	urn:www.agenziaentrate.gov.it:specificheTecniche:sco:common
children	<a href="#">Correttiva</a> <a href="#">IntegrativaAFavore</a> <a href="#">Integrativa</a> <a href="#">IntegrativaArt2Co8Ter</a>

element **Tipo\_Dichiarazione\_Type/Correttiva**

diagram	
namespace	urn:www.agenziaentrate.gov.it:specificheTecniche:sco:common
type	<a href="#">DatoCB_Type</a>
facets	Kind Value pattern [01]

element **Tipo\_Dichiarazione\_Type/IntegrativaAFavore**

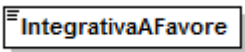
diagram	
namespace	urn:www.agenziaentrate.gov.it:specificheTecniche:sco:common

type	<a href="#">DatoCB_Type</a>
facets	Kind Value pattern [01]

#### element [Tipo\\_Dichiarazione\\_Type/Integrativa](#)

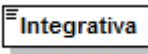
diagram	
namespace	urn:www.agenziaentrate.gov.it:specificheTecniche:sco:common
type	<a href="#">DatoCB_Type</a>
facets	Kind Value pattern [01]

#### element [Tipo\\_Dichiarazione\\_Type/IntegrativaArt2Co8Ter](#)

diagram	
namespace	urn:www.agenziaentrate.gov.it:specificheTecniche:sco:common
type	<a href="#">DatoCB_Type</a>
facets	Kind Value pattern [01]

#### complexType [Visto\\_Conformita\\_Type](#)

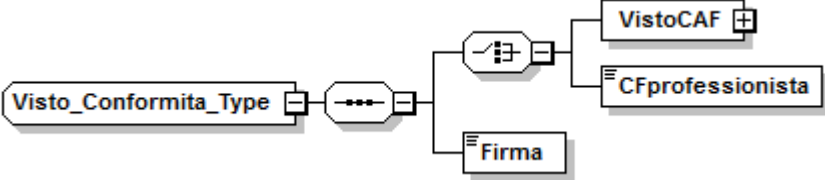
diagram	
namespace	urn:www.agenziaentrate.gov.it:specificheTecniche:sco:common
children	<a href="#">VistoCAF</a> <a href="#">CFprofessionista</a> <a href="#">Firma</a>

#### element [Visto\\_Conformita\\_Type/VistoCAF](#)

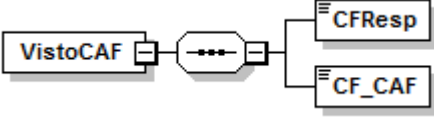
diagram	
namespace	urn:www.agenziaentrate.gov.it:specificheTecniche:sco:common
children	<a href="#">CFResp</a> <a href="#">CF_CAF</a>

element **Visto\_Conformita\_Type/VistoCAF/CFResp**

diagram					
namespace	urn:www.agenziaentrate.gov.it:specificheTecniche:sco:common				
type	<a href="#">DatoCF_Type</a>				
facets	<table border="1"> <thead> <tr> <th>Kind</th> <th>Value</th> </tr> </thead> <tbody> <tr> <td>pattern</td> <td>[0-9]{11}[A-Z]{6}[0-9LMNPQRSTUVWXYZ]{2}[A-Z]{1}[0-9LMNPQRSTUVWXYZ]{2}[A-Z]{1}[0-9LMNPQRSTUVWXYZ]{3}[A-Z]{1}</td> </tr> </tbody> </table>	Kind	Value	pattern	[0-9]{11}[A-Z]{6}[0-9LMNPQRSTUVWXYZ]{2}[A-Z]{1}[0-9LMNPQRSTUVWXYZ]{2}[A-Z]{1}[0-9LMNPQRSTUVWXYZ]{3}[A-Z]{1}
Kind	Value				
pattern	[0-9]{11}[A-Z]{6}[0-9LMNPQRSTUVWXYZ]{2}[A-Z]{1}[0-9LMNPQRSTUVWXYZ]{2}[A-Z]{1}[0-9LMNPQRSTUVWXYZ]{3}[A-Z]{1}				

element **Visto\_Conformita\_Type/VistoCAF/CF\_CAF**

diagram					
namespace	urn:www.agenziaentrate.gov.it:specificheTecniche:sco:common				
type	<a href="#">DatoCN_Type</a>				
facets	<table border="1"> <thead> <tr> <th>Kind</th> <th>Value</th> </tr> </thead> <tbody> <tr> <td>pattern</td> <td>[0-9]{11}</td> </tr> </tbody> </table>	Kind	Value	pattern	[0-9]{11}
Kind	Value				
pattern	[0-9]{11}				

element **Visto\_Conformita\_Type/CFprofessionista**

diagram					
namespace	urn:www.agenziaentrate.gov.it:specificheTecniche:sco:common				
type	<a href="#">DatoCF_Type</a>				
facets	<table border="1"> <thead> <tr> <th>Kind</th> <th>Value</th> </tr> </thead> <tbody> <tr> <td>pattern</td> <td>[0-9]{11}[A-Z]{6}[0-9LMNPQRSTUVWXYZ]{2}[A-Z]{1}[0-9LMNPQRSTUVWXYZ]{2}[A-Z]{1}[0-9LMNPQRSTUVWXYZ]{3}[A-Z]{1}</td> </tr> </tbody> </table>	Kind	Value	pattern	[0-9]{11}[A-Z]{6}[0-9LMNPQRSTUVWXYZ]{2}[A-Z]{1}[0-9LMNPQRSTUVWXYZ]{2}[A-Z]{1}[0-9LMNPQRSTUVWXYZ]{3}[A-Z]{1}
Kind	Value				
pattern	[0-9]{11}[A-Z]{6}[0-9LMNPQRSTUVWXYZ]{2}[A-Z]{1}[0-9LMNPQRSTUVWXYZ]{2}[A-Z]{1}[0-9LMNPQRSTUVWXYZ]{3}[A-Z]{1}				

element **Visto\_Conformita\_Type/Firma**

diagram					
namespace	urn:www.agenziaentrate.gov.it:specificheTecniche:sco:common				
type	<a href="#">DatoCB_Type</a>				
facets	<table border="1"> <thead> <tr> <th>Kind</th> <th>Value</th> </tr> </thead> <tbody> <tr> <td>pattern</td> <td>[01]</td> </tr> </tbody> </table>	Kind	Value	pattern	[01]
Kind	Value				
pattern	[01]				

complexType **Scelta2PerMille\_Type**

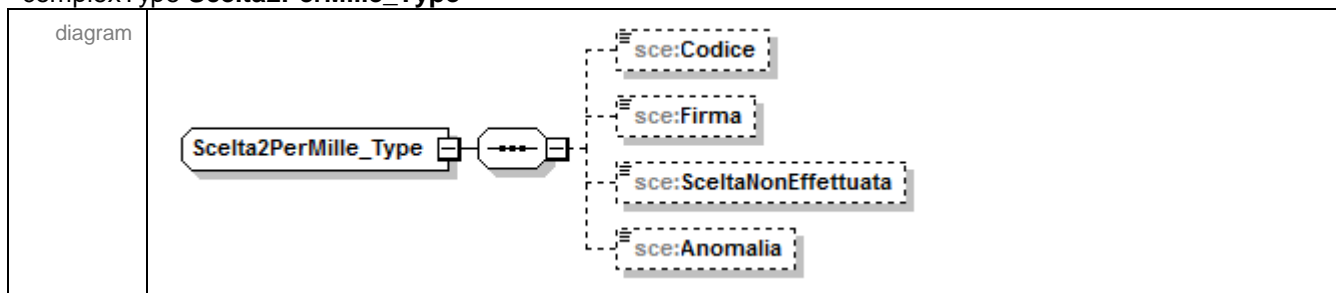

namespace	urn:www.agenziaentrate.gov.it:specificheTecniche:sco:sce
children	<a href="#">sce:Codice</a> <a href="#">sce:Firma</a> <a href="#">sce:SceltaNonEffettuata</a> <a href="#">sce:Anomalia</a>

#### element **Scelta2PerMille\_Type/Codice**

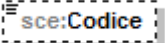
diagram					
namespace	urn:www.agenziaentrate.gov.it:specificheTecniche:sco:sce				
type	<a href="#">DatoAN_Type</a>				
facets	<table border="1"> <tr> <td>Kind</td> <td>Value</td> </tr> <tr> <td>pattern</td> <td>([0-9A-Z\-\&amp;quot;]{1}){([ 0-9A-Z&amp;amp;] \- \., / \^\(\ \)\À É È Ò Ù Û &amp;quot; \ \ /+)*</td> </tr> </table>	Kind	Value	pattern	([0-9A-Z\-\&quot;]{1}){([ 0-9A-Z&amp;] \- \., / \^\(\ \)\À É È Ò Ù Û &quot; \ \ /+)*
Kind	Value				
pattern	([0-9A-Z\-\&quot;]{1}){([ 0-9A-Z&amp;] \- \., / \^\(\ \)\À É È Ò Ù Û &quot; \ \ /+)*				

#### element **Scelta2PerMille\_Type/Firma**

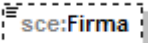
diagram					
namespace	urn:www.agenziaentrate.gov.it:specificheTecniche:sco:sce				
type	<a href="#">DatoCB_Type</a>				
facets	<table border="1"> <tr> <td>Kind</td> <td>Value</td> </tr> <tr> <td>pattern</td> <td>[01]</td> </tr> </table>	Kind	Value	pattern	[01]
Kind	Value				
pattern	[01]				

#### element **Scelta2PerMille\_Type/SceltaNonEffettuata**

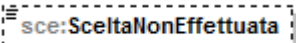
diagram					
namespace	urn:www.agenziaentrate.gov.it:specificheTecniche:sco:sce				
type	<a href="#">DatoCB_Type</a>				
facets	<table border="1"> <tr> <td>Kind</td> <td>Value</td> </tr> <tr> <td>pattern</td> <td>[01]</td> </tr> </table>	Kind	Value	pattern	[01]
Kind	Value				
pattern	[01]				

#### element **Scelta2PerMille\_Type/Anomalia**

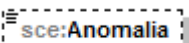
diagram													
namespace	urn:www.agenziaentrate.gov.it:specificheTecniche:sco:sce												
type	restriction of <a href="#">DatoN1_Type</a>												
facets	<table border="1"> <tr> <td>Kind</td> <td>Value</td> </tr> <tr> <td>pattern</td> <td>[1-9]</td> </tr> <tr> <td>enumeration</td> <td>1</td> </tr> <tr> <td>enumeration</td> <td>2</td> </tr> <tr> <td>enumeration</td> <td>3</td> </tr> <tr> <td>enumeration</td> <td>4</td> </tr> </table>	Kind	Value	pattern	[1-9]	enumeration	1	enumeration	2	enumeration	3	enumeration	4
Kind	Value												
pattern	[1-9]												
enumeration	1												
enumeration	2												
enumeration	3												
enumeration	4												



complexType **Scelta2PerMilleAssCult\_Type**

diagram	
namespace	urn:www.agenziaentrate.gov.it:specificheTecniche:sco:sce
type	extension of <a href="#">Firma_Type</a>
children	<a href="#">Firma</a> <a href="#">CodiceFiscale</a> <a href="#">sce:SceltaNonEffettuata</a> <a href="#">sce:Anomalia</a>

element **Scelta2PerMilleAssCult\_Type/SceltaNonEffettuata**

diagram					
namespace	urn:www.agenziaentrate.gov.it:specificheTecniche:sco:sce				
type	<a href="#">DatoCB_Type</a>				
facets	<table border="1"> <thead> <tr> <th>Kind</th> <th>Value</th> </tr> </thead> <tbody> <tr> <td>pattern</td> <td>[01]</td> </tr> </tbody> </table>	Kind	Value	pattern	[01]
Kind	Value				
pattern	[01]				

element **Scelta2PerMilleAssCult\_Type/Anomalia**

diagram													
namespace	urn:www.agenziaentrate.gov.it:specificheTecniche:sco:sce												
type	restriction of <a href="#">DatoN1_Type</a>												
facets	<table border="1"> <thead> <tr> <th>Kind</th> <th>Value</th> </tr> </thead> <tbody> <tr> <td>pattern</td> <td>[1-9]</td> </tr> <tr> <td>enumeration</td> <td>1</td> </tr> <tr> <td>enumeration</td> <td>2</td> </tr> <tr> <td>enumeration</td> <td>4</td> </tr> <tr> <td>enumeration</td> <td>5</td> </tr> </tbody> </table>	Kind	Value	pattern	[1-9]	enumeration	1	enumeration	2	enumeration	4	enumeration	5
Kind	Value												
pattern	[1-9]												
enumeration	1												
enumeration	2												
enumeration	4												
enumeration	5												

complexType **Scelta5PerMille\_Type**

<p>diagram</p>	
<p>namespace</p>	<p>urn:www.agenziaentrate.gov.it:specificheTecniche:sco:sce</p>
<p>children</p>	<p><a href="#">sce:SostegnoVolontariatoNonLucrative</a> <a href="#">sce:RicercaScientifica</a> <a href="#">sce:RicercaSanitaria</a> <a href="#">sce:BeniCulturaliPaesaggistici</a> <a href="#">sce:SostegnoSocialeComune</a> <a href="#">sce:SostegnoAssociazioniSportive</a> <a href="#">sce:SostegnoEntiAreeProtette</a> <a href="#">sce:SceltaNonEffetuata</a> <a href="#">sce:Anomalia</a> <a href="#">sce:FlagAnomaliaCFbeneficiario</a></p>

element **Scelta5PerMille\_Type/SostegnoVolontariatoNonLucrative**

<p>diagram</p>	
<p>namespace</p>	<p>urn:www.agenziaentrate.gov.it:specificheTecniche:sco:sce</p>
<p>type</p>	<p><a href="#">Firma_Type</a></p>
<p>children</p>	<p><a href="#">Firma</a> <a href="#">CodiceFiscale</a></p>

element **Scelta5PerMille\_Type/RicercaScientifica**

diagram	
namespace	urn:www.agenziaentrate.gov.it:specificheTecniche:sco:sce
type	<a href="#">Firma_Type</a>
children	<a href="#">Firma</a> <a href="#">CodiceFiscale</a>

element **Scelta5PerMille\_Type/RicercaSanitaria**

diagram	
namespace	urn:www.agenziaentrate.gov.it:specificheTecniche:sco:sce
type	<a href="#">Firma_Type</a>
children	<a href="#">Firma</a> <a href="#">CodiceFiscale</a>

element **Scelta5PerMille\_Type/BeniCulturaliPaesaggistici**

diagram	
namespace	urn:www.agenziaentrate.gov.it:specificheTecniche:sco:sce
type	<a href="#">Firma_Type</a>
children	<a href="#">Firma</a> <a href="#">CodiceFiscale</a>

element **Scelta5PerMille\_Type/SostegnoSocialeComune**

diagram	
namespace	urn:www.agenziaentrate.gov.it:specificheTecniche:sco:sce

children	<a href="#">sce:Firma</a>
----------	---------------------------

element **Scelta5PerMille\_Type/SostegnoSocialeComune/Firma**

diagram	
namespace	urn:www.agenziaentrate.gov.it:specificheTecniche:sco:sce
type	<a href="#">DatoCB_Type</a>
facets	Kind Value pattern [01]

element **Scelta5PerMille\_Type/SostegnoAssociazioniSportive**

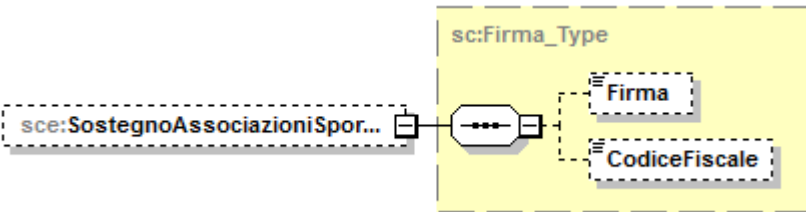
diagram	
namespace	urn:www.agenziaentrate.gov.it:specificheTecniche:sco:sce
type	<a href="#">Firma_Type</a>
children	<a href="#">Firma</a> <a href="#">CodiceFiscale</a>

element **Scelta5PerMille\_Type/SostegnoEntiAreeProtette**

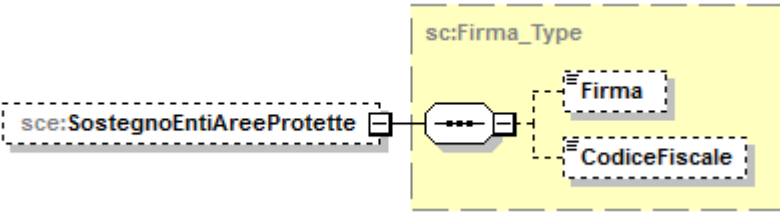
diagram	
namespace	urn:www.agenziaentrate.gov.it:specificheTecniche:sco:sce
type	<a href="#">Firma_Type</a>
children	<a href="#">Firma</a> <a href="#">CodiceFiscale</a>

element **Scelta5PerMille\_Type/SceltaNonEffettuata**

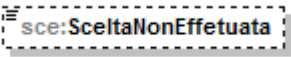
diagram	
namespace	urn:www.agenziaentrate.gov.it:specificheTecniche:sco:sce
type	<a href="#">DatoCB_Type</a>

facets	Kind	Value
	pattern	[01]

element **Scelta5PerMille\_Type/Anomalia**

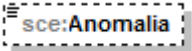
diagram		
namespace	urn:www.agenziaentrate.gov.it:specificheTecniche:sco:sce	
type	restriction of <a href="#">DatoN1_Type</a>	
facets	Kind	Value
	pattern	[1-9]
	enumeration	1
	enumeration	2
	enumeration	3
	enumeration	4
	enumeration	5

element **Scelta5PerMille\_Type/FlagAnomaliaCFbeneficiario**

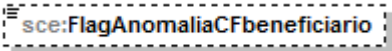
diagram		
namespace	urn:www.agenziaentrate.gov.it:specificheTecniche:sco:sce	
type	<a href="#">DatoCB_Type</a>	
facets	Kind	Value
	pattern	[01]

complexType **Scelta8PerMille\_Type**

diagram	
namespace	urn:www.agenziaentrate.gov.it:specificheTecniche:sco:sce
children	<a href="#">sce:Stato</a> <a href="#">sce:ChiesaCattolica</a> <a href="#">sce:UnioneChieseCristianeAvventiste7giorno</a> <a href="#">sce:AssembleeDiDioInItalia</a> <a href="#">sce:UnioneDelleChieseMetodisteValdesi</a> <a href="#">sce:ChiesaEvangelicaLuteranaInItalia</a> <a href="#">sce:UnioneComunitaEbraicheItaliane</a> <a href="#">sce:SacraArcidiocesiOrtodossaEsarcato</a> <a href="#">sce:ChiesaApostolicaItalia</a> <a href="#">sce:UnioneCristianaEvangelicaBattista</a> <a href="#">sce:UnioneBuddhistaitaliana</a> <a href="#">sce:UnioneInduistaitaliana</a> <a href="#">sce:IstitutoBuddistalbisg</a> <a href="#">sce:SceltaNonEffettuata</a> <a href="#">sce:Anomalia</a>

element **Scelta8PerMille\_Type/Stato**

diagram					
namespace	urn:www.agenziaentrate.gov.it:specificheTecniche:sco:sce				
type	<a href="#">DatoCB_Type</a>				
facets	<table border="1"> <tr> <td>Kind</td> <td>Value</td> </tr> <tr> <td>pattern</td> <td>[01]</td> </tr> </table>	Kind	Value	pattern	[01]
Kind	Value				
pattern	[01]				

element **Scelta8PerMille\_Type/ChiesaCattolica**

diagram	 <b>sce:ChiesaCattolica</b>
namespace	urn:www.agenziaentrate.gov.it:specificheTecniche:sco:sce
type	<a href="#">DatoCB_Type</a>
facets	Kind Value pattern [01]

element **Scelta8PerMille\_Type/UnioneChieseCristianeAvventiste7giorno**

diagram	 <b>sce:UnioneChieseCristianeAvve...</b>
namespace	urn:www.agenziaentrate.gov.it:specificheTecniche:sco:sce
type	<a href="#">DatoCB_Type</a>
facets	Kind Value pattern [01]

element **Scelta8PerMille\_Type/AssembleeDiDiolnItalia**

diagram	 <b>sce:AssembleeDiDiolnItalia</b>
namespace	urn:www.agenziaentrate.gov.it:specificheTecniche:sco:sce
type	<a href="#">DatoCB_Type</a>
facets	Kind Value pattern [01]

element **Scelta8PerMille\_Type/UnioneDelleChieseMetodisteValdesi**

diagram	 <b>sce:UnioneDelleChieseMetodist...</b>
namespace	urn:www.agenziaentrate.gov.it:specificheTecniche:sco:sce
type	<a href="#">DatoCB_Type</a>
facets	Kind Value pattern [01]

element **Scelta8PerMille\_Type/ChiesaEvangelicaLuteranaInItalia**

diagram	 <b>sce:ChiesaEvangelicaLuteranaIn...</b>
namespace	urn:www.agenziaentrate.gov.it:specificheTecniche:sco:sce
type	<a href="#">DatoCB_Type</a>
facets	Kind Value pattern [01]

element **Scelta8PerMille\_Type/UnioneComunitaEbraicheItaliane**

diagram	 <code>sce:UnioneComunitaEbraicheItal...</code>				
namespace	urn:www.agenziaentrate.gov.it:specificheTecniche:sco:sce				
type	<a href="#">DatoCB_Type</a>				
facets	<table border="1"> <thead> <tr> <th>Kind</th> <th>Value</th> </tr> </thead> <tbody> <tr> <td>pattern</td> <td>[01]</td> </tr> </tbody> </table>	Kind	Value	pattern	[01]
Kind	Value				
pattern	[01]				

element **Scelta8PerMille\_Type/SacraArcidiocesiOrtodossaEsarcato**

diagram	 <code>sce:SacraArcidiocesiOrtodossa...</code>				
namespace	urn:www.agenziaentrate.gov.it:specificheTecniche:sco:sce				
type	<a href="#">DatoCB_Type</a>				
facets	<table border="1"> <thead> <tr> <th>Kind</th> <th>Value</th> </tr> </thead> <tbody> <tr> <td>pattern</td> <td>[01]</td> </tr> </tbody> </table>	Kind	Value	pattern	[01]
Kind	Value				
pattern	[01]				

element **Scelta8PerMille\_Type/ChiesaApostolicaItalia**

diagram	 <code>sce:ChiesaApostolicaItalia</code>				
namespace	urn:www.agenziaentrate.gov.it:specificheTecniche:sco:sce				
type	<a href="#">DatoCB_Type</a>				
facets	<table border="1"> <thead> <tr> <th>Kind</th> <th>Value</th> </tr> </thead> <tbody> <tr> <td>pattern</td> <td>[01]</td> </tr> </tbody> </table>	Kind	Value	pattern	[01]
Kind	Value				
pattern	[01]				

element **Scelta8PerMille\_Type/UnioneCristianaEvangelicaBattista**

diagram	 <code>sce:UnioneCristianaEvangelicaB...</code>				
namespace	urn:www.agenziaentrate.gov.it:specificheTecniche:sco:sce				
type	<a href="#">DatoCB_Type</a>				
facets	<table border="1"> <thead> <tr> <th>Kind</th> <th>Value</th> </tr> </thead> <tbody> <tr> <td>pattern</td> <td>[01]</td> </tr> </tbody> </table>	Kind	Value	pattern	[01]
Kind	Value				
pattern	[01]				

element **Scelta8PerMille\_Type/UnioneBuddhistaitaliana**

diagram	 <code>sce:UnioneBuddhistaitaliana</code>				
namespace	urn:www.agenziaentrate.gov.it:specificheTecniche:sco:sce				
type	<a href="#">DatoCB_Type</a>				
facets	<table border="1"> <thead> <tr> <th>Kind</th> <th>Value</th> </tr> </thead> <tbody> <tr> <td>pattern</td> <td>[01]</td> </tr> </tbody> </table>	Kind	Value	pattern	[01]
Kind	Value				
pattern	[01]				

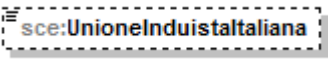

element **Scelta8PerMille\_Type/UnioneInduistaltaliana**

diagram	
namespace	urn:www.agenziaentrate.gov.it:specificheTecniche:sco:sce
type	<a href="#">DatoCB_Type</a>
facets	Kind Value pattern [01]

element **Scelta8PerMille\_Type/IstitutoBuddistalbisg**

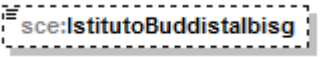
diagram	
namespace	urn:www.agenziaentrate.gov.it:specificheTecniche:sco:sce
type	<a href="#">DatoCB_Type</a>
facets	Kind Value pattern [01]

element **Scelta8PerMille\_Type/SceltaNonEffettuata**

diagram	
namespace	urn:www.agenziaentrate.gov.it:specificheTecniche:sco:sce
type	<a href="#">DatoCB_Type</a>
facets	Kind Value pattern [01]

element **Scelta8PerMille\_Type/Anomalia**

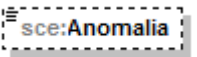
diagram	
namespace	urn:www.agenziaentrate.gov.it:specificheTecniche:sco:sce
type	restriction of <a href="#">DatoN1_Type</a>
facets	Kind Value pattern [1-9] enumeration 1 enumeration 2 enumeration 3

### complexType Scelte\_Type

diagram	
namespace	urn:www.agenziaentrate.gov.it:specificheTecniche:sco:sce
children	<a href="#">sce:Scelta5PerMille</a> <a href="#">sce:Scelta8PerMille</a> <a href="#">sce:Scelta2PerMille</a>

### element Scelte\_Type/Scelta5PerMille

diagram	
namespace	urn:www.agenziaentrate.gov.it:specificheTecniche:sco:sce
type	<a href="#">sce:Scelta5PerMille_Type</a>
children	<a href="#">sce:SostegnoVolontariatoNonLucrative</a> <a href="#">sce:RicercaScientifica</a> <a href="#">sce:RicercaSanitaria</a> <a href="#">sce:BeniCulturaliPaesaggistici</a> <a href="#">sce:SostegnoSocialeComune</a> <a href="#">sce:SostegnoAssociazioniSportive</a> <a href="#">sce:SostegnoEntiAreeProtette</a> <a href="#">sce:SceltaNonEffettuata</a> <a href="#">sce:Anomalia</a> <a href="#">sce:FlagAnomaliaCFbeneficiario</a>

element **Scelte\_Type/Scelta8PerMille**

<p>diagram</p>	
<p>namespace</p>	<p>urn:www.agenziaentrate.gov.it:specificheTecniche:sco:sce</p>
<p>type</p>	<p><a href="#">sce:Scelta8PerMille_Type</a></p>
<p>children</p>	<p><a href="#">sce:Stato</a> <a href="#">sce:ChiesaCattolica</a> <a href="#">sce:UnioneChieseCristianeAvventiste7giorno</a> <a href="#">sce:AssembleeDiDiolnItalia</a> <a href="#">sce:UnioneDelleChieseMetodisteValdesi</a> <a href="#">sce:ChiesaEvangelicaLuteranaInItalia</a> <a href="#">sce:UnioneComunitaEbraicheitaliane</a> <a href="#">sce:SacraArcidiocesiOrtodossaEsarcato</a> <a href="#">sce:ChiesaApostolicaItalia</a> <a href="#">sce:UnioneCristianaEvangelicaBattista</a> <a href="#">sce:UnioneBuddhistaitaliana</a> <a href="#">sce:UnioneInduistaitaliana</a> <a href="#">sce:IstitutoBuddistalbisg</a> <a href="#">sce:SceltaNonEffettuata</a> <a href="#">sce:Anomalia</a></p>

element **Scelte\_Type/Scelta2PerMille**

diagram	
namespace	urn:www.agenziaentrate.gov.it:specificheTecniche:sco:sce
type	<a href="#">sce:Scelta2PerMille_Type</a>
children	<a href="#">sce:Codice</a> <a href="#">sce:Firma</a> <a href="#">sce:SceltaNonEffettuata</a> <a href="#">sce:Anomalia</a>

simpleType **DatoAN\_Type**

namespace	urn:www.agenziaentrate.gov.it:specificheTecniche:common				
type	restriction of <b>xs:string</b>				
facets	<table border="1"> <tr> <td>Kind</td> <td>Value</td> </tr> <tr> <td>pattern</td> <td>([0-9A-Z\-\_]&amp;quot;){1}([ 0-9A-Z&amp;amp;:] ' - \., / ^ \^\(\ \) À È É Ì Ò Ù Ú &amp;quot; \\ / +)*</td> </tr> </table>	Kind	Value	pattern	([0-9A-Z\-\_]&quot;){1}([ 0-9A-Z&amp;:] ' - \., / ^ \^\(\ \) À È É Ì Ò Ù Ú &quot; \\ / +)*
Kind	Value				
pattern	([0-9A-Z\-\_]&quot;){1}([ 0-9A-Z&amp;:] ' - \., / ^ \^\(\ \) À È É Ì Ò Ù Ú &quot; \\ / +)*				

simpleType **DatoCB12\_Type**

namespace	urn:www.agenziaentrate.gov.it:specificheTecniche:common				
type	restriction of <b>xs:byte</b>				
facets	<table border="1"> <tr> <td>Kind</td> <td>Value</td> </tr> <tr> <td>pattern</td> <td>[10]{12}</td> </tr> </table>	Kind	Value	pattern	[10]{12}
Kind	Value				
pattern	[10]{12}				

simpleType **DatoCB\_Type**

namespace	urn:www.agenziaentrate.gov.it:specificheTecniche:common				
type	restriction of <b>xs:byte</b>				
facets	<table border="1"> <tr> <td>Kind</td> <td>Value</td> </tr> <tr> <td>pattern</td> <td>[01]</td> </tr> </table>	Kind	Value	pattern	[01]
Kind	Value				
pattern	[01]				

simpleType **DatoCF\_Type**

namespace	urn:www.agenziaentrate.gov.it:specificheTecniche:common				
type	restriction of <b>xs:string</b>				
facets	<table border="1"> <tr> <td>Kind</td> <td>Value</td> </tr> <tr> <td>pattern</td> <td>[0-9]{11}[A-Z]{6}[0-9LMNPQRSTUVWXYZ]{2}[A-Z]{1}[0-9LMNPQRSTUVWXYZ]{2}[A-Z]{1}[0-9LMNPQRSTUVWXYZ]{3}[A-Z]{1}</td> </tr> </table>	Kind	Value	pattern	[0-9]{11}[A-Z]{6}[0-9LMNPQRSTUVWXYZ]{2}[A-Z]{1}[0-9LMNPQRSTUVWXYZ]{2}[A-Z]{1}[0-9LMNPQRSTUVWXYZ]{3}[A-Z]{1}
Kind	Value				
pattern	[0-9]{11}[A-Z]{6}[0-9LMNPQRSTUVWXYZ]{2}[A-Z]{1}[0-9LMNPQRSTUVWXYZ]{2}[A-Z]{1}[0-9LMNPQRSTUVWXYZ]{3}[A-Z]{1}				



type	restriction of <b>xs:string</b>				
facets	<table border="1"> <tr> <td>Kind</td> <td>Value</td> </tr> <tr> <td>pattern</td> <td>[a-zA-Z0-9._%'\-&amp;quot;?^~=]+@[a-zA-Z0-9.\-]+\.[a-zA-Z]{2,4}</td> </tr> </table>	Kind	Value	pattern	[a-zA-Z0-9._%'\-&quot;?^~=]+@[a-zA-Z0-9.\-]+\.[a-zA-Z]{2,4}
Kind	Value				
pattern	[a-zA-Z0-9._%'\-&quot;?^~=]+@[a-zA-Z0-9.\-]+\.[a-zA-Z]{2,4}				

#### simpleType **DatoGA\_Type**

namespace	urn:www.agenziaentrate.gov.it:specificheTecniche:common				
type	restriction of <b>xs:string</b>				
facets	<table border="1"> <tr> <td>Kind</td> <td>Value</td> </tr> <tr> <td>pattern</td> <td>[1-9]((1-9)[0-9]) ((12)[0-9][0-9]) (3[0-5][0-9]) (36[0-5])</td> </tr> </table>	Kind	Value	pattern	[1-9]((1-9)[0-9]) ((12)[0-9][0-9]) (3[0-5][0-9]) (36[0-5])
Kind	Value				
pattern	[1-9]((1-9)[0-9]) ((12)[0-9][0-9]) (3[0-5][0-9]) (36[0-5])				

#### simpleType **DatoN1\_Type**

namespace	urn:www.agenziaentrate.gov.it:specificheTecniche:common				
type	restriction of <b>xs:string</b>				
facets	<table border="1"> <tr> <td>Kind</td> <td>Value</td> </tr> <tr> <td>pattern</td> <td>[1-9]</td> </tr> </table>	Kind	Value	pattern	[1-9]
Kind	Value				
pattern	[1-9]				

#### simpleType **DatoNP\_Type**

namespace	urn:www.agenziaentrate.gov.it:specificheTecniche:common				
type	restriction of <b>xs:string</b>				
facets	<table border="1"> <tr> <td>Kind</td> <td>Value</td> </tr> <tr> <td>pattern</td> <td>[1-9]{1}[0-9]*</td> </tr> </table>	Kind	Value	pattern	[1-9]{1}[0-9]*
Kind	Value				
pattern	[1-9]{1}[0-9]*				

#### simpleType **DatoNU\_Type**

namespace	urn:www.agenziaentrate.gov.it:specificheTecniche:common				
type	restriction of <b>xs:string</b>				
facets	<table border="1"> <tr> <td>Kind</td> <td>Value</td> </tr> <tr> <td>pattern</td> <td>(-[1-9] 1-9)[0-9]*</td> </tr> </table>	Kind	Value	pattern	(-[1-9] 1-9)[0-9]*
Kind	Value				
pattern	(-[1-9] 1-9)[0-9]*				

#### simpleType **DatoPC\_Type**

namespace	urn:www.agenziaentrate.gov.it:specificheTecniche:common				
type	restriction of <b>xs:string</b>				
facets	<table border="1"> <tr> <td>Kind</td> <td>Value</td> </tr> <tr> <td>pattern</td> <td>[0-9]?[0-9](,\d{1,3})? 100,(0{1,3})?</td> </tr> </table>	Kind	Value	pattern	[0-9]?[0-9](,\d{1,3})? 100,(0{1,3})?
Kind	Value				
pattern	[0-9]?[0-9](,\d{1,3})? 100,(0{1,3})?				

#### simpleType **DatoPI\_Type**

namespace	urn:www.agenziaentrate.gov.it:specificheTecniche:common				
type	restriction of <b>xs:string</b>				
facets	<table border="1"> <tr> <td>Kind</td> <td>Value</td> </tr> <tr> <td>pattern</td> <td>[0-7][0-9]{10}</td> </tr> </table>	Kind	Value	pattern	[0-7][0-9]{10}
Kind	Value				
pattern	[0-7][0-9]{10}				

### simpleType DatoQU\_Type

namespace	urn:www.agenziaentrate.gov.it:specificheTecniche:common				
type	restriction of <b>xs:string</b>				
facets	<table border="1"> <thead> <tr> <th>Kind</th> <th>Value</th> </tr> </thead> <tbody> <tr> <td>pattern</td> <td>[0-9]+,(0-9){1,5)?</td> </tr> </tbody> </table>	Kind	Value	pattern	[0-9]+,(0-9){1,5)?
Kind	Value				
pattern	[0-9]+,(0-9){1,5)?				

### simpleType DatoTL\_Type

namespace	urn:www.agenziaentrate.gov.it:specificheTecniche:common				
type	restriction of <b>xs:string</b>				
facets	<table border="1"> <thead> <tr> <th>Kind</th> <th>Value</th> </tr> </thead> <tbody> <tr> <td>pattern</td> <td>[0-9]*</td> </tr> </tbody> </table>	Kind	Value	pattern	[0-9]*
Kind	Value				
pattern	[0-9]*				

### simpleType DatoVP\_Type

namespace	urn:www.agenziaentrate.gov.it:specificheTecniche:common				
type	restriction of <b>xs:string</b>				
facets	<table border="1"> <thead> <tr> <th>Kind</th> <th>Value</th> </tr> </thead> <tbody> <tr> <td>pattern</td> <td>[0-9]+,[0-9]{2}</td> </tr> </tbody> </table>	Kind	Value	pattern	[0-9]+,[0-9]{2}
Kind	Value				
pattern	[0-9]+,[0-9]{2}				

### simpleType Casella\_Quadro\_Type

namespace	urn:www.agenziaentrate.gov.it:specificheTecniche:sco:common												
type	restriction of <a href="#">DatoAN_Type</a>												
facets	<table border="1"> <thead> <tr> <th>Kind</th> <th>Value</th> </tr> </thead> <tbody> <tr> <td>pattern</td> <td>(([0-9A-Z\-\ ]&amp;quot;){1}([ 0-9A-Z&amp;amp;#92; ' \- \., / ° °\ °\( \) À É É ì ò ù ü &amp;quot; \ \\ / +)*</td> </tr> <tr> <td>enumeration</td> <td>0</td> </tr> <tr> <td>enumeration</td> <td>1</td> </tr> <tr> <td>enumeration</td> <td>2</td> </tr> <tr> <td>enumeration</td> <td>3</td> </tr> </tbody> </table>	Kind	Value	pattern	(([0-9A-Z\-\ ]&quot;){1}([ 0-9A-Z&amp;#92; ' \- \., / ° °\ °\( \) À É É ì ò ù ü &quot; \ \\ / +)*	enumeration	0	enumeration	1	enumeration	2	enumeration	3
Kind	Value												
pattern	(([0-9A-Z\-\ ]&quot;){1}([ 0-9A-Z&amp;#92; ' \- \., / ° °\ °\( \) À É É ì ò ù ü &quot; \ \\ / +)*												
enumeration	0												
enumeration	1												
enumeration	2												
enumeration	3												

### simpleType Codice\_Carica\_Type

namespace	urn:www.agenziaentrate.gov.it:specificheTecniche:sco:common																																		
type	restriction of <a href="#">DatoNP_Type</a>																																		
facets	<table border="1"> <thead> <tr> <th>Kind</th> <th>Value</th> </tr> </thead> <tbody> <tr> <td>pattern</td> <td>[1-9]{1}[0-9]*</td> </tr> <tr> <td>enumeration</td> <td>1</td> </tr> <tr> <td>enumeration</td> <td>2</td> </tr> <tr> <td>enumeration</td> <td>3</td> </tr> <tr> <td>enumeration</td> <td>4</td> </tr> <tr> <td>enumeration</td> <td>5</td> </tr> <tr> <td>enumeration</td> <td>6</td> </tr> <tr> <td>enumeration</td> <td>7</td> </tr> <tr> <td>enumeration</td> <td>8</td> </tr> <tr> <td>enumeration</td> <td>9</td> </tr> <tr> <td>enumeration</td> <td>10</td> </tr> <tr> <td>enumeration</td> <td>11</td> </tr> <tr> <td>enumeration</td> <td>12</td> </tr> <tr> <td>enumeration</td> <td>13</td> </tr> <tr> <td>enumeration</td> <td>14</td> </tr> <tr> <td>enumeration</td> <td>15</td> </tr> </tbody> </table>	Kind	Value	pattern	[1-9]{1}[0-9]*	enumeration	1	enumeration	2	enumeration	3	enumeration	4	enumeration	5	enumeration	6	enumeration	7	enumeration	8	enumeration	9	enumeration	10	enumeration	11	enumeration	12	enumeration	13	enumeration	14	enumeration	15
Kind	Value																																		
pattern	[1-9]{1}[0-9]*																																		
enumeration	1																																		
enumeration	2																																		
enumeration	3																																		
enumeration	4																																		
enumeration	5																																		
enumeration	6																																		
enumeration	7																																		
enumeration	8																																		
enumeration	9																																		
enumeration	10																																		
enumeration	11																																		
enumeration	12																																		
enumeration	13																																		
enumeration	14																																		
enumeration	15																																		





	enumeration	30
	enumeration	31
	enumeration	32
	enumeration	33
	enumeration	34
	enumeration	35
	enumeration	36
	enumeration	37
	enumeration	38
	enumeration	39
	enumeration	40
	enumeration	41
	enumeration	42
	enumeration	43
	enumeration	44
	enumeration	45
	enumeration	50
	enumeration	51
	enumeration	52
	enumeration	53
	enumeration	54
	enumeration	55
	enumeration	56
	enumeration	57
	enumeration	58
	enumeration	59

### simpleType Sesso\_Type

namespace	urn:www.agenziaentrate.gov.it:specificheTecniche:sco:common	
type	restriction of <a href="#">DatoAN_Type</a>	
facets	Kind	Value
	pattern	[(0-9A-Z-] &quot;){1}([ 0-9A-Z&amp;] ' - \., / ° √ (\\) À É Ê Ë Ì Ò Ù Ü &quot;; \\ / +)*
	enumeration	M
	enumeration	F

### simpleType Situazione\_Type

namespace	urn:www.agenziaentrate.gov.it:specificheTecniche:sco:common	
type	restriction of <a href="#">DatoNP_Type</a>	
facets	Kind	Value
	pattern	[1-9]{1}[0-9]*
	enumeration	1
	enumeration	2
	enumeration	3
	enumeration	4
	enumeration	5
	enumeration	6
	enumeration	7

### simpleType Stato\_Type

namespace	urn:www.agenziaentrate.gov.it:specificheTecniche:sco:common	
type	restriction of <a href="#">DatoNP_Type</a>	
facets	Kind	Value
	pattern	[1-9]{1}[0-9]*
	enumeration	1
	enumeration	2
	enumeration	3

	enumeration 4
--	---------------

### simpleType **Eventi\_Ecc\_Type**

namespace	urn:www.agenziaentrato.gov.it:specificheTecniche:sco:common										
type	restriction of <b>xs:string</b>										
facets	<table border="1"> <thead> <tr> <th>Kind</th> <th>Value</th> </tr> </thead> <tbody> <tr> <td>enumeration</td> <td>1</td> </tr> <tr> <td>enumeration</td> <td>2</td> </tr> <tr> <td>enumeration</td> <td>3</td> </tr> <tr> <td>enumeration</td> <td>4</td> </tr> </tbody> </table>	Kind	Value	enumeration	1	enumeration	2	enumeration	3	enumeration	4
Kind	Value										
enumeration	1										
enumeration	2										
enumeration	3										
enumeration	4										

### simpleType **Estero**

namespace	urn:www.agenziaentrato.gov.it:specificheTecniche:common				
type	restriction of <b>xs:string</b>				
facets	<table border="1"> <thead> <tr> <th>Kind</th> <th>Value</th> </tr> </thead> <tbody> <tr> <td>enumeration</td> <td>EE</td> </tr> </tbody> </table>	Kind	Value	enumeration	EE
Kind	Value				
enumeration	EE				

### simpleType **PE\_Type**

namespace	urn:www.agenziaentrato.gov.it:specificheTecniche:common
type	union of ( <a href="#">Provincieltaliane</a> , <a href="#">Estero</a> )

### simpleType **PN\_Type**

namespace	urn:www.agenziaentrato.gov.it:specificheTecniche:common
type	union of ( <a href="#">Provincieltaliane</a> , <a href="#">ProvinciaCroate</a> , <a href="#">Estero</a> , <a href="#">ProvinciaSoppresse</a> )

### simpleType **PR\_Type**

namespace	urn:www.agenziaentrato.gov.it:specificheTecniche:common
type	union of ( <a href="#">Provincieltaliane</a> )

### simpleType **ProvinciaCroate**

namespace	urn:www.agenziaentrato.gov.it:specificheTecniche:common								
type	restriction of <b>xs:string</b>								
facets	<table border="1"> <thead> <tr> <th>Kind</th> <th>Value</th> </tr> </thead> <tbody> <tr> <td>enumeration</td> <td>FU</td> </tr> <tr> <td>enumeration</td> <td>PL</td> </tr> <tr> <td>enumeration</td> <td>ZA</td> </tr> </tbody> </table>	Kind	Value	enumeration	FU	enumeration	PL	enumeration	ZA
Kind	Value								
enumeration	FU								
enumeration	PL								
enumeration	ZA								

### simpleType **Provincieltaliane**

namespace	urn:www.agenziaentrato.gov.it:specificheTecniche:common
-----------	---

type	restriction of <b>xs:string</b>	
facets	Kind	Value
	enumeration	AG
	enumeration	AL
	enumeration	AN
	enumeration	AO
	enumeration	AP
	enumeration	AQ
	enumeration	AR
	enumeration	AT
	enumeration	AV
	enumeration	BA
	enumeration	BG
	enumeration	BI
	enumeration	BL
	enumeration	BN
	enumeration	BO
	enumeration	BR
	enumeration	BS
	enumeration	BT
	enumeration	BZ
	enumeration	CA
	enumeration	CB
	enumeration	CE
	enumeration	CH
	enumeration	CI
	enumeration	CL
	enumeration	CN
	enumeration	CO
	enumeration	CR
	enumeration	CS
	enumeration	CT
	enumeration	CZ
	enumeration	EN
	enumeration	FC
	enumeration	FE
	enumeration	FG
	enumeration	FI
	enumeration	FM
	enumeration	FR
	enumeration	GE
	enumeration	GO
	enumeration	GR
	enumeration	IM
	enumeration	IS
	enumeration	KR
	enumeration	LC
	enumeration	LE
	enumeration	LI
enumeration	LO	
enumeration	LT	
enumeration	LU	
enumeration	MB	
enumeration	MC	
enumeration	ME	
enumeration	MI	
enumeration	MN	
enumeration	MO	
enumeration	MS	
enumeration	MT	
enumeration	NA	
enumeration	NO	
enumeration	NU	
enumeration	OG	
enumeration	OR	
enumeration	OT	
enumeration	PA	

enumeration	PC
enumeration	PD
enumeration	PE
enumeration	PG
enumeration	PI
enumeration	PN
enumeration	PO
enumeration	PR
enumeration	PT
enumeration	PU
enumeration	PV
enumeration	PZ
enumeration	RA
enumeration	RC
enumeration	RE
enumeration	RG
enumeration	RI
enumeration	RM
enumeration	RN
enumeration	RO
enumeration	SA
enumeration	SI
enumeration	SO
enumeration	SP
enumeration	SR
enumeration	SS
enumeration	SV
enumeration	TA
enumeration	TE
enumeration	TN
enumeration	TO
enumeration	TP
enumeration	TR
enumeration	TS
enumeration	TV
enumeration	UD
enumeration	VA
enumeration	VB
enumeration	VC
enumeration	VE
enumeration	VI
enumeration	VR
enumeration	VS
enumeration	VT
enumeration	VV

simpleType **ProvinciaSopresse**

namespace	urn:www.agenziaentrate.gov.it:specificheTecniche:common						
type	restriction of <b>xs:string</b>						
facets	<table border="1"> <thead> <tr> <th>Kind</th> <th>Value</th> </tr> </thead> <tbody> <tr> <td>enumeration</td> <td>FO</td> </tr> <tr> <td>enumeration</td> <td>PS</td> </tr> </tbody> </table>	Kind	Value	enumeration	FO	enumeration	PS
Kind	Value						
enumeration	FO						
enumeration	PS						

Schema **fornitura734\_2018\_v1.xsd**

schema location: **fornitura734\_2018\_v1.xsd**  
 attributeFormDefault: **unqualified**  
 elementFormDefault: **qualified**  
 targetNamespace: **urn:www.agenziaentrate.gov.it:specificheTecniche:sco:730**

Elements

[Fornitura730-4](#)

element **Fornitura730-4**

diagram	<p>The diagram shows the Fornitura730-4 element as a container with a dashed line and a plus sign. It contains two child elements: m730:Intestazione and m730:Documento_730-4. The m730:Documento_730-4 element has a multiplicity of 1..∞.</p>
namespace	urn:www.agenziaentrate.gov.it:specificheTecniche:sco:730
children	<a href="#">m730:Intestazione</a> <a href="#">m730:Documento_730-4</a>

element **Fornitura730-4/Intestazione**

diagram	<p>The diagram shows the m730:Intestazione element as a container with a dashed line and a plus sign. It contains six child elements: m730:CodiceFornitura, m730:TipoFornitore, m730:Protocollo, m730:Annullamento, m730:TotaleDocumenti, and m730:SpazioServizioTelematico. The last three elements are shown with dashed boxes, indicating they are optional.</p>
namespace	urn:www.agenziaentrate.gov.it:specificheTecniche:sco:730
children	<a href="#">m730:CodiceFornitura</a> <a href="#">m730:TipoFornitore</a> <a href="#">m730:Protocollo</a> <a href="#">m730:Annullamento</a> <a href="#">m730:TotaleDocumenti</a> <a href="#">m730:SpazioServizioTelematico</a>

element **Fornitura730-4/Intestazione/CodiceFornitura**

diagram	<p>The diagram shows the m730:CodiceFornitura element as a simple box with a plus sign.</p>				
namespace	urn:www.agenziaentrate.gov.it:specificheTecniche:sco:730				
type	<a href="#">DatoAN_Type</a>				
facets	<table border="0"> <tr> <td>Kind</td> <td>Value</td> </tr> <tr> <td>pattern</td> <td>([0-9A-Z\-\-]]&amp;quot;){1}([ 0-9A-Z&amp;amp;:] ' \- \., / ^ \^\( \) À É È Ì Ò Ù Û &amp;quot; \ \  \+)*</td> </tr> </table>	Kind	Value	pattern	([0-9A-Z\-\-]]&quot;){1}([ 0-9A-Z&amp;:] ' \- \., / ^ \^\( \) À É È Ì Ò Ù Û &quot; \ \  \+)*
Kind	Value				
pattern	([0-9A-Z\-\-]]&quot;){1}([ 0-9A-Z&amp;:] ' \- \., / ^ \^\( \) À É È Ì Ò Ù Û &quot; \ \  \+)*				

element **Fornitura730-4/Intestazione/TipoFornitore**

diagram	<p>The diagram shows the m730:TipoFornitore element as a simple box with a plus sign.</p>
namespace	urn:www.agenziaentrate.gov.it:specificheTecniche:sco:730

type	<a href="#">DatoNP_Type</a>
facets	Kind Value pattern [1-9]{1}[0-9]*

#### element Fornitura730-4/Intestazione/Protocollo

diagram	
namespace	urn:www.agenziaentrate.gov.it:specificheTecniche:sco:730
type	restriction of <a href="#">DatoAN_Type</a>
facets	Kind Value pattern ([0-9A-Z-] \&quot;){1}([ 0-9A-Z&amp;:] \- \., / \^\(\ \) À É È Ì Ò Ù Û \&quot; \ \\ \ +)*

#### element Fornitura730-4/Intestazione/Annullamento

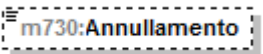
diagram	
namespace	urn:www.agenziaentrate.gov.it:specificheTecniche:sco:730
type	<a href="#">DatoCB_Type</a>
facets	Kind Value pattern [01]

#### element Fornitura730-4/Intestazione/TotaleDocumenti

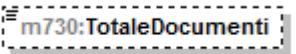
diagram	
namespace	urn:www.agenziaentrate.gov.it:specificheTecniche:sco:730
type	<a href="#">DatoNP_Type</a>
facets	Kind Value pattern [1-9]{1}[0-9]*

#### element Fornitura730-4/Intestazione/SpazioServizioTelematico

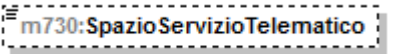
diagram	
namespace	urn:www.agenziaentrate.gov.it:specificheTecniche:sco:730
type	restriction of <a href="#">DatoAN_Type</a>
facets	Kind Value pattern ([0-9A-Z-] \&quot;){1}([ 0-9A-Z&amp;:] \- \., / \^\(\ \) À É È Ì Ò Ù Û \&quot; \ \\ \ +)*

element **Fornitura730-4/Documento\_730-4**

<p>diagram</p>	
<p>namespace</p>	<p>urn:www.agenziaentrate.gov.it:specificheTecniche:sco:730</p>
<p>type</p>	<p><a href="#">m730:Documento_730-4</a></p>